

CARLISLE
SUNPATH
TUBULAR SKYLIGHT



Tubular Daylighting Device with Proven Performance

SunPath™ Tubular Daylighting Device (TDD)

Carlisle's SunPath TDD is a perfect complement to the company's SunWeld industrial skylights, providing increased daylighting opportunities for a variety of applications. The SunPath TDD features a high-impact acrylic dome fused to an aluminum mounting ring that joins to a seamless aluminum flashing to provide unmatched strength and durability. The interior light tube utilizes an advanced reflection technology that provides superior light transmission and optimal interior daylighting.

SunPath TDDs are ideal for use in:

- » Warehouses with high inventory racks
- » Classrooms that require convenient lighting control
- » Roof systems with minimal truss or joist spacing
- » Suspended or hard-ceiling applications

FEATURES AND BENEFITS

- » 100% impact-modified acrylic domes
- » Unique rolled-lock aluminum retainer ring
- » Seamless aluminum flashing (.080 GA Series 1100)
- » Three (3) diffuser options for even light distribution
- » ENERGY STAR®-qualified for all climate zones
- » 98% reflective Alanod Miro-Silver lining
- » Eco-smart triple-glazed diffuser assembly (0.21 U-value / 0.26 SHGC)
- » Standard prismatic scatter disk insert within dome assembly
- » Three (3) dimmer system options (manual, switch-activated and IR remote)
- » Seamless aluminum curb cap flashing (no painted steel or plastic)

LIGHT PERFORMANCE

The SunPath high-performance tubular skylight brings natural light into almost any dark or unlit space. Daylight transmits through the clear top dome to a prismatic diffuser, which disperses the light evenly throughout the space. The chart below serves as a design guide to assist the specifier with approximating the number of TDDs required, based upon diameter size for a given square-foot area. The projections assume a ceiling height of 8-10 feet.

Model Diameter	Approximate Coverage Area	Approximate Light Output (lumens)
10"	150 ft ²	Up to 3750
13"	250 ft ²	Up to 6500
18"	400 ft ²	Up to 11000
21"	500 ft ²	Up to 13900
24"	600 ft ²	Up to 16500

Figures produced under the right conditions.

Time of day, season, length of tube and elbows will vary light output.





ALANOD'S MIRO-SILVER® PERFORMANCE

The SunPath TDD light tube utilizes Miro-Silver to create pure white light with no color shift during transmission, even after multiple reflections. At nearly 98% total light reflectivity, these Miro-Silver light tubes allow daylight to illuminate interior spaces longer, and brighter, than any other TDD. Compared to polymer-laminated light tubes common in other TDDs, the SunPath's Miro-Silver light tube will not experience a rapid decline in reflectivity after installation.

Benefits of Miro-Silver Light Tubes:

- » Solid reflective material, NOT a laminated polymer sheet
- » Will not delaminate, yellow, crack or peel due to prolonged UV exposure
- » 25-year material warranty

Reflector Material under different angles

Comparison between MIRO-SILVER and Multi-layer Polymeric Film (MPF)

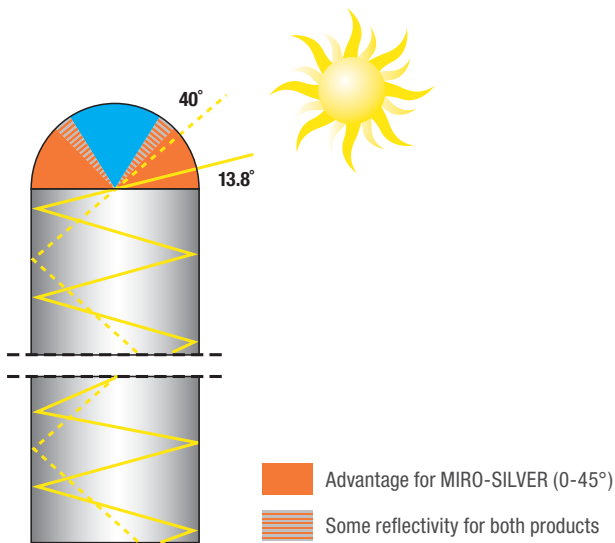

MIRO-SILVER light pipes transmit much more light between 0 and 45° – when usable light is really needed.

Total Reflection is % Under an Angle of:

	13.8°	40°
MIRO-SILVER	98.16	98.22
MPF	96.78	97.66

Tube 3 meters (10 ft) length x 300 mm (12 in) diameter

Angle 13.8°	Output	MIRO-SILVER Advantage
MIRO-SILVER	0.48	+78%
MPF	0.27	0%

Tube 3 meters (10 ft) length x 300 mm (12 in) diameter

Angle 40°	Output	MIRO-SILVER Advantage
MIRO-SILVER	0.82	+17%
MPF	0.70	0%

Number of Reflections

13.8°	40 Reflections	78%
40.0°	11 Reflections	17%

Reflectivity-Over-Time-Test – MIRO-SILVER vs. Multi-layer Polymeric Film

Comparison of sustained reflectivity after 150 hours UV-C Exposure

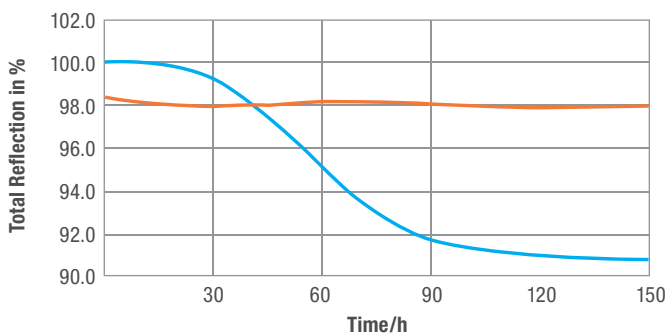

- MIRO-SILVER
- Multi-Layer Polymeric Film

MIRO-SILVER produces sustained reflectivity over time





System Components and Accessories

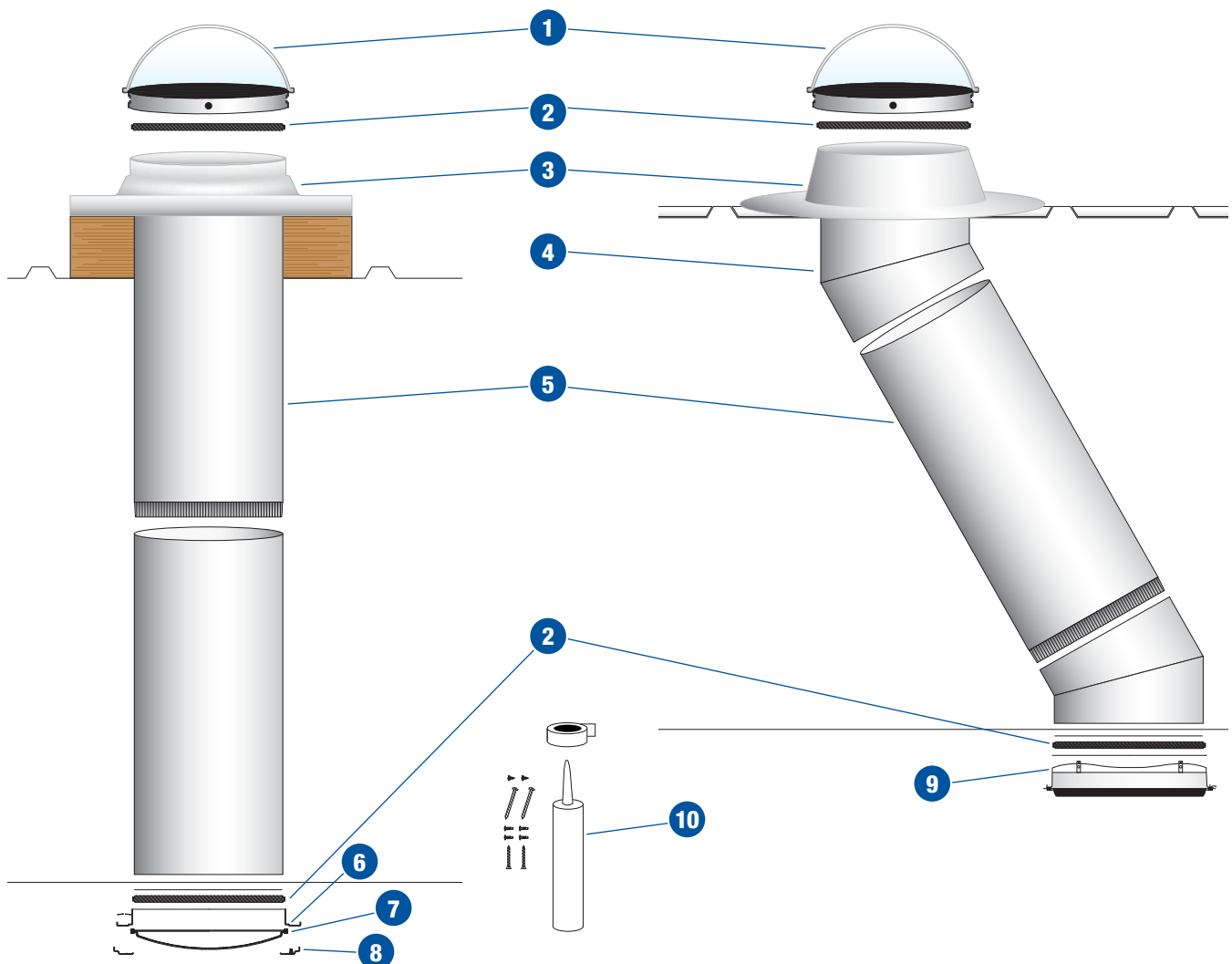

SYSTEM COMPONENTS

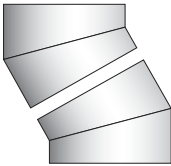
- 1 Impact-Modified Acrylic Dome Assembly with Scatter Disk
- 2 Dust Seal
- 3 **Left:** .080 Seamless Curb Cap Flashing
Right: Round Flat-Roof Aluminum Flashing Housing (optional pitched roof version available)
- 4 Adjustable Elbow (0° - 45°)
- 5 98% Reflective Light Tube (24" long sections)
- 6 Aluminum Trim Ring
- 7 Double Glazed Light Diffuser
- 8 Ceiling Decorative Ring
(Industrial Kit Diffuser attaches directly to light tube when no ceiling exists)
- 9 2' x 2' Round-to-Square Transition Sleeve with Diffuser (21" only) for Suspended Ceilings (optional)
- 10 Hardware Kit

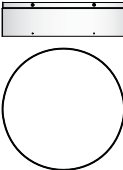

SYSTEM ACCESSORIES

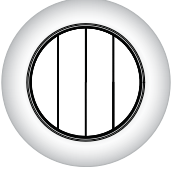
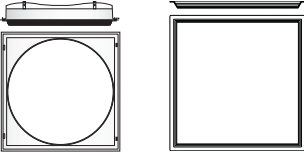
Product	Description
 24" Light Tube	24"-long tubes utilize Alanod Miro Silver for high reflectivity and long-term UV resistance.
 Set of 2 Elbows	14"-long elbows allow easy routing around obstructions 0-45° adjustment, depending on size.
 Round Flashing Housing	Manufactured from .080 GA Aluminum, this housing comes standard 6" or 9" for flat roof applications. Pitched roof flashings are available.
 3" Flashing Extension	This component attaches to round flashing housing when additional height above the roof deck is required (3" increments).
 Cap Flashing	Used on a flat roof with a site-built or pre-manufactured metal curb. Manufactured from .080 Series 1100 aluminum.

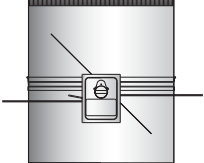
Product	Description
 Security Bar	Three aluminum bars welded into a perimeter ring. Inserts into flashing turret.
 Office Kit – Suspended Ceilings Prismatic Diffuser	This 2' x 2' round-to square transition piece snaps into the metal ceiling grid. Several diffuser options are available to insert into frame.
 Trim Ring – Hard Ceiling	This white powdercoated aluminum ring provides a finished appearance to the installation.
 Trim Ring – Open Ceiling	A highly polished aluminum retainer ring attaches the diffuser directly to the light tube and is packaged with the Industrial Kit.
 Dimmer System	Three options available: <ul style="list-style-type: none"> • Manual • Switch-activated with synchronization capability • IR remote – full control of damper rotation

Max Glow Diffuser Option

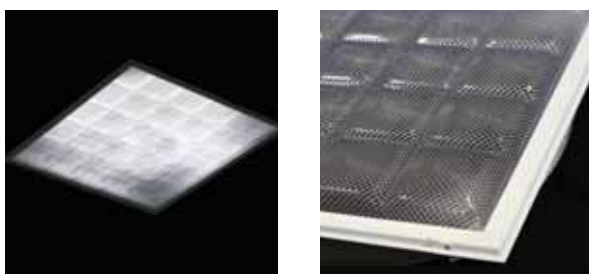

Prefabricated Flashing Sleeve



Typical Specification and Ordering

TYPICAL SPECIFICATION

Dome Assembly:

Vacuum-formed, .220"-thick, 100% high-impact clear acrylic dome with UV stabilization, CC2 light-transmitting plastic material, non-yellowing. Mounted and sealed to .080"-thick, 1100-0 aluminum dome ring. Engineered to eliminate heat and moisture.

Light Scatter Disk:

110"-thick, 100% high-impact acrylic prismatic disk with UV stabilization inserts into dome assembly to minimize heat transfer.

Dust Seal:

Used between dome ring – Flashing, Flashing – light tube, and light tube – transition box. Polypropylene weather-strip pile with 3M® adhesive backing to prevent bug, dirt and air infiltration.

Roof Flashing:

One-piece, seamless, .080"-thick 1100-0 aluminum flashing.

Options:

Flat – 4", 6", 8", 9" and 11" height with 4"-wide base to seal securely onto roof.

Pitched – for 3/12-pitched roofs; can be used on higher pitch roofs with elbows.

Curb – Inside dimensions are 27" x 27"

Light Tube:

Anodized aluminum Miro 27 Silver, .020" thickness, 98% reflectivity, resistant to moisture, corrosion and extreme temperatures.

Type A standard kit includes: (2) 24" tubes

Type B kit includes: (1) 24" tube and (2) 14" elbows

Optical Properties of MIRO 27 SILVER

Total Light Reflection	(\$1)[%]	≥ 98	DIN 5036-3 (U-Globe)
Total Light Reflection	(\$1)[%]	≥ 98	ASTM E-1651 (TR-2)
Diffuse Light Reflection	(\$1)[%]	< 6	DIN 5036-3 (U-Globe)
Solar Reflection	(\$1)[%]	95	DIN EN 410
Brightness	along: []	93	ISO 7768 (60°/calibrated 91.8)
	across: []	92	ISO 7768 (60°/calibrated 91.8)
Brightness	Image Clarity []	≥ 97	ASTM E-430 (Hunter Dorigon)
	Diffuseness []	0.00	ASTM E-430 (Hunter Dorigon)
Color Values	b*[]	0 b* +5	DIN 5033-4 10°

The SunPath TDD was evaluated in full compliance with NFRC (National Fenestration Rating Council) requirements for U-Factor and Solar Heat Gain Coefficient to the standards listed below:

Standard	Title of Test	Results
NFRC 100-2004	U Factor (Standard Done Assembly) (Eco-Smart Assembly)	0.46 0.21
NFRC 200-2004	Solar Heat Gain Coefficient (Standard) (Eco-Smart Assembly)	0.33 0.26

Condensational Control

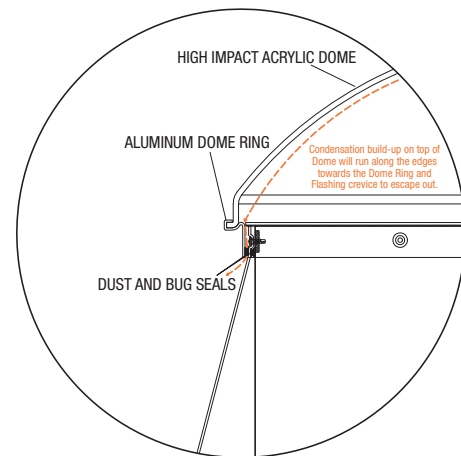

Eco-Smart Diffuser System

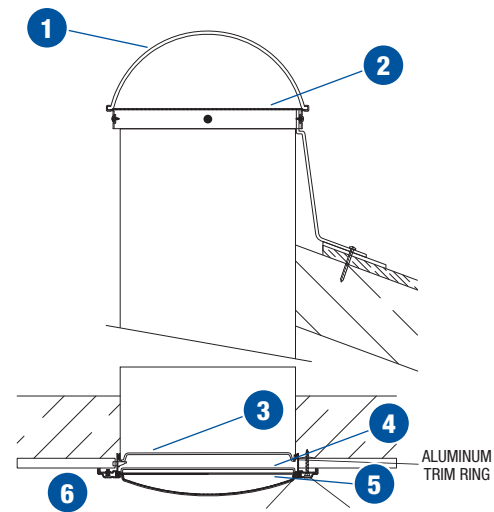

- 1 Dome Assembly
- 2 Scatter Disk
- 3 4th Heat-Insulating Panel
- 4 3rd Heat-Insulating Panel
- 5 2nd Heat-Insulating Panel
- 6 1st Heat-Insulating Panel

ORDERING REQUIREMENTS/CHECKLIST

Diameter: 10" 13" 18" 21" 24" (13" and 21" standard, all others are special order)

Roof Slope: Flat Pitched (Above 2:12)

Type of Ceiling: Open Suspended Hard

Length of Run: (Distance from roof deck to ceiling +12") _____ feet

Straight Run or Elbows Required: Type A (no elbows, 2 pc. 24" tube) Type B (with a set of 2 elbows, 1 pc. 24" tube)

Type of Flashing: Round Curb Cap Flashing (fits on field fabricated square curb)

Type of Diffuser: Prismatic Opal Max Glow

Optional Accessories: 3" Flashing Extenders Dimmer Systems (manual/switch controlled/IR remote)
 One Piece Flashing Sleeves Electric Light Kits
 Security Bar Kits Eco-Smart Model
 2' x 2' Round-to-Square Kit for Suspended Ceiling

Wireless Dimmer



Electric Light Kit



Curb Cap Flashing

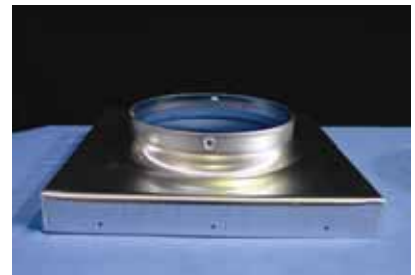

3" Flashing Extender



Security Bar Kit



SunPath Warranty

Carlisle SynTec Systems warrants against manufacturing defects, corrosion, rust, deterioration, fading and breakage on all components for a 10-year period of time from the date of purchase.

This warranty is subject to proper installation of the unit in accordance with the manufacturer's written installation instructions. This warranty does not apply where repairs or alterations have been made or attempted by others, or the unit has been abused and/or misused.

EXPERIENCE THE CARLISLE DIFFERENCE



Before



400 Watt Metal Halides



21" SunPath Industrial Kits

SUNPATH VS. COMPETITOR

Feature	SunPath	Competitor
Dome	100% Impact Modified Acrylic .220"-thick CC2 Material	Type DA Acrylic CC2 Material .143"-thick
Flashing	.080 Aluminum 1100 Series	Stamped Painted Steel (.028"-thick) or Plastic
Dome Attachment	Unique Aluminum Retainer Ring	Through Dome (Stress Point)
Light Tubes	98% Reflective 24"-Long Less Seams	Claim 99% Reflective 16"-Long
UV Degradation After 150 Hours	<1%	>7%
Elbows	Yes	Yes
Flashing Designs: Pitched Roof	Yes	Yes
Flashing Designs: Flat Roof	Yes	Yes
Flashing Designs: Curb Mount	Yes	Yes
Diffusers: Flat, Dual-Glazed	Yes	Yes
Diffusers: Convex, Dual-Glazed	Yes	Yes
Diffuser Trim Ring	Powder-Coated Aluminum	Plastic
Design and Layout Support	Free	Do-it-Yourself Guidelines
Parent Company	USA	Australia
ENERGY STAR Model	Yes	Yes
ICC Approval	Yes	Yes
NFRC Approval	Yes	Yes
Office Kit with 2' x 2' diffuser	Yes	Yes
Fresnel Lens	Alternate-MaxGlow (Dual-Glazed)	Yes (NOT Dual-Glazed)
Electric Light Kit (1 and 2 bulb)	Yes	Yes
Bath Exhaust Fan	Yes	Yes
Tube Sizes	10", 13", 18", 21" and 24"	10", 14" and 21"
Warranty	Total Roof System Warranty	Material Only
Dimmer	Electric, IR Remote, and Manual	Electric Only



800-479-6832 | P.O. Box 7000 | Carlisle, PA 17013 | Fax: 717-245-7053 | www.carlisesyntec.com