

# Grand Manor® and Carriage House®

# 17

## YOUR OBJECTIVE:

To learn the correct method of installing each of these roofing products.

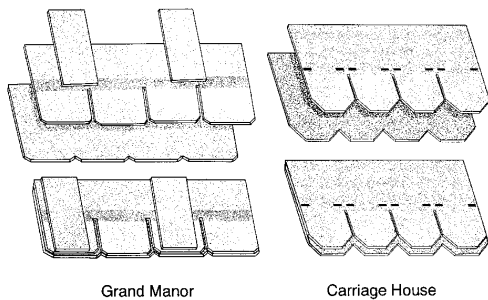

Figure 17-1: Super Heavy-Weight Construction.

These types of super heavy-weight shingles were invented by CertainTeed, and are made of two full laminated shingles. The bottom laminate is a full-size shingle without slots or cutouts. The top laminate shingle incorporates color, shape and design options. Grand Manor® also has one or more smaller tabs attached to the top full shingle to enhance its dimensionality (Figure 17-1).

These shingles feature the benefit of multiple-layer water protection. This means that, when installed, four full shingles are layered over the entire roof. This is quadruple coverage!

Other features of these shingles include:

- ◆ Extra large 18" x 36" shingles installed at an 8" exposure.
- ◆ Fastening, steep slopes, and flashing requirements are special because of the thickness, design, and weight of the products.

For UL FIRE Rating, underlayment may be required. Apply flat and unwrinkled.

**STANDARD OR STEEP SLOPES:** CertainTeed recommends DiamondDeck®, Synthetic Underlayment, RoofRunner™ or shingle underlayment meeting ASTM D226, D4869 or D6757. Always ensure sufficient deck ventilation, and take particular care when DiamondDeck, RoofRunner or other synthetic underlayment is installed. Follow manufacturer's application instructions.

**LOW SLOPES:** All roof shingles applied to a low slope deck (2" to below 4" per foot) require the use of CertainTeed WinterGuard® or Grace Ice & Water Shield® Waterproofing Shingle Underlayment, or its equivalent,\* applied over the entire deck surface. Consult the WinterGuard or Grace Ice & Water Shield and individual shingle application instructions for details.

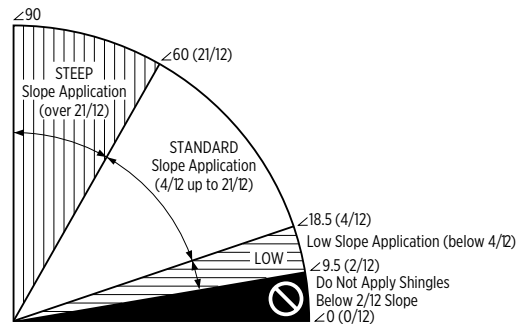

Figure 17-2: Slope definitions.

\*For low slopes, underlayment equivalents to WinterGuard or Grace Ice & Water Shield include:

- 1) waterproofing shingle underlayments meeting ASTM D1970;
- 2) in areas not prone to snow or ice, two layers of 36" (915 mm wide felt shingle underlayment lapped 19" (485 mm).
- 3) in areas not prone to snow or ice, two layers of CertainTeed's DiamondDeck or RoofRunner™ in shingle fashion (half lap) per the low-slope application instructions.

Shingle underlayment should meet ASTM D6757, ASTM D4869 Type I or ASTM D226 Type I Ensure sufficient deck ventilation when DiamondDeck, RoofRunner or other synthetic underlayment is installed.

The roof deck\* must be at least: 3/8" (9.5 mm) thick plywood, or 7/16" (11 mm) thick non-veneer, or nominal 1" (25 mm) thick wood deck.

**COLD WEATHER CLIMATES (ALL SLOPES):** Application of WinterGuard or Grace Ice & Water Shield or a waterproofing shingle underlayment meeting ASTM D1970 is strongly recommended whenever there is a possibility of ice build-up. Follow manufacturer's application instructions.

**FLASHING:** Corrosion-resistant flashing must be used to help prevent leaks where a roof meets a wall, another roof, a chimney or other objects that penetrate a roof.

**SEALING:** Shingle sealing may be delayed if shingles are applied in cool weather and may be further delayed by airborne dust accumulation. If any shingles have not sealed after a reasonable time period, hand sealing may be necessary.

**CAUTION:** To prevent cracking, shingles must be sufficiently warm to allow proper forming for hips and ridges.

**WARRANTY:** These shingles are warranted against manufacturing defects and are covered by SureStart™ protection. See the warranty itself for specific details and limitations.

\*

For technical questions, information on acceptable alternative application methods and materials, or a copy of the product warranty, contact the sources listed below:		Warranty	Alternate Instructions	Technical Questions
Your supplier or roofing applicator		✓		
CertainTeed Home Institute	800-782-8777	✓	✓	
CertainTeed-RPG Technical Services	800-345-1145	✓	✓	✓

## FASTENING

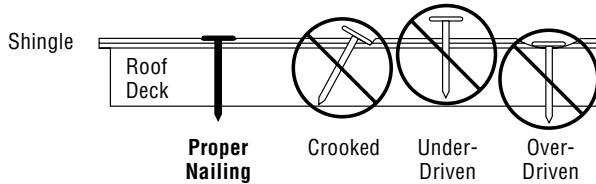

Figure 17-3: Proper and improper nailing.

**IMPORTANT:** For decks 3/4" (19 mm) thick or thicker, nails must go at least 3/4" (19 mm) into the deck. On thinner decks, nails must go at least 1/8" (3.2 mm) through the deck.

Nails must be 11- or 12-gauge roofing nails, corrosion-resistant, with at least 3/8" (9.5 mm) heads, and at least 1-1/2" (38 mm) long for clean-decks and 1-3/4" (44 mm) long for roof-overs using Grand Manor®; for Carriage House® nails must be 1-1/4" (31 mm) long for clean-decks and 1-1/2" (38 mm) long for roof-overs.

NOTE: Nails are required for these products.

### LOW AND STANDARD SLOPE

Use five nails for every full shingle.

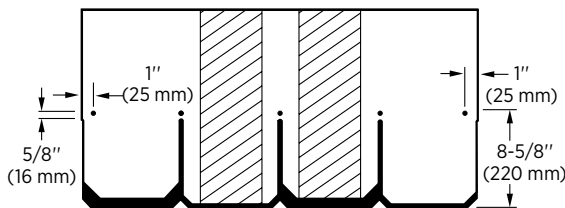

Figure 17-4: Use five nails for every full Grand Manor, or Carriage House.

### STEEP SLOPE

Use seven nails and three spots of asphalt roofing cement for every full Grand Manor. Use five nails and three spots of asphalt roofing cement for every full Carriage House. Apply asphalt roofing cement 1" (25 mm) from edge of shingle (Figure 17-5). Asphalt roofing cement meeting ASTM D 4586 Type II is suggested.

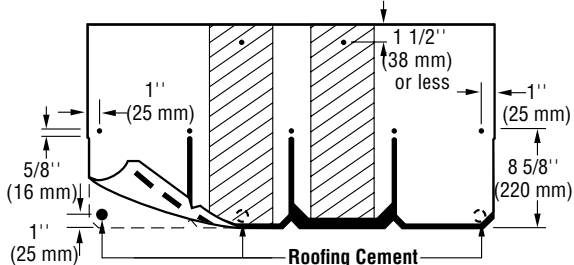

Figure 17-5: When installing Grand Manor on steep slopes, use seven nails and three spots of asphalt roofing cement.

**IMPORTANT:** To prevent slippage of the laminated tabs (shown cross-hatched above) when individual shingles meet a wall, ridge, and on steep slopes (greater than 21" per foot), each laminated tab at the junction must be fastened individually with an additional fastener as shown. Fasteners applied to the tabs in this manner are to be horizontally centered on the laminated tab and placed within 1-1/2" of the upper edge of the shingle. To protect against slippage of the laminated tabs during application of these shingles in hot weather, it might become necessary to fasten all the tabs individually as described above. This would require the use of an additional 100 nails per standard square.

CAUTION: Excessive use of roofing cement can cause shingles to blister.

## CLEAN-DECK APPLICATION METHOD FOR GRAND MANOR OR CARRIAGE HOUSE

### FOUR-AND-ONE-HALF-INCH OFFSET, SINGLE-COLUMN, VERTICAL RACKING METHOD ("RACKING")

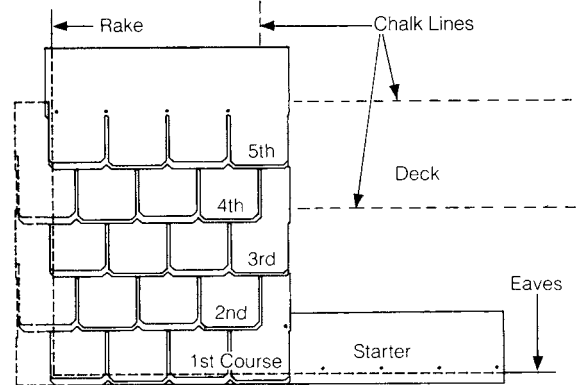

Figure 17-6: Vertical Racking Method.

### STARTER COURSE:

- ◆ When installing Grand Manor, the starter course is made of the shingle itself, from which the 8" lower portion has been removed, or of CertainTeed high-performance starter (10").

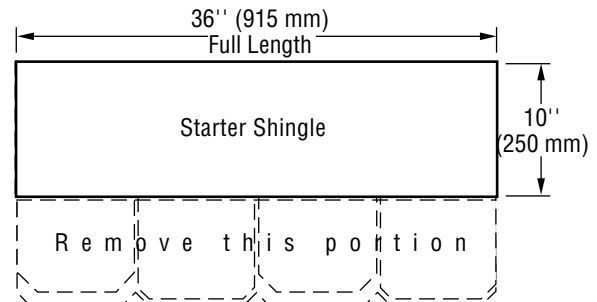

Figure 17-7: Make starter shingles by removing the 8" lower portion.

- ◆ When installing Carriage House, the starter course will consist of Carriage House shingles from which the 8" lower portion has been removed. The easiest way to do this is by cutting straight across the length of the shingle just above the top of the cutouts (Figure 17-7).

## Here's a Tip...

Make sure you have many large new hook blades on hand when installing these products. Cutting the double-thick shingles from the top granule side will quickly dull the blades.

- ◆ For both shingle styles, cut 4-1/2" off the length of the left side of the first starter strip and apply at the lower left corner of the roof. This 31-1/2" starter strip should overhang the rakes and eaves 1/2" when drip edge is used or 3/4" when no drip edge is used. Continue with full 36" lengths of starter strips all along the eaves (Figure 17-8).

**1ST COURSE:** The first course starts with a full shingle at the lower left corner of the roof. Keep the tabs flush with the left and bottom edges of the starter course (Figure 17-9).

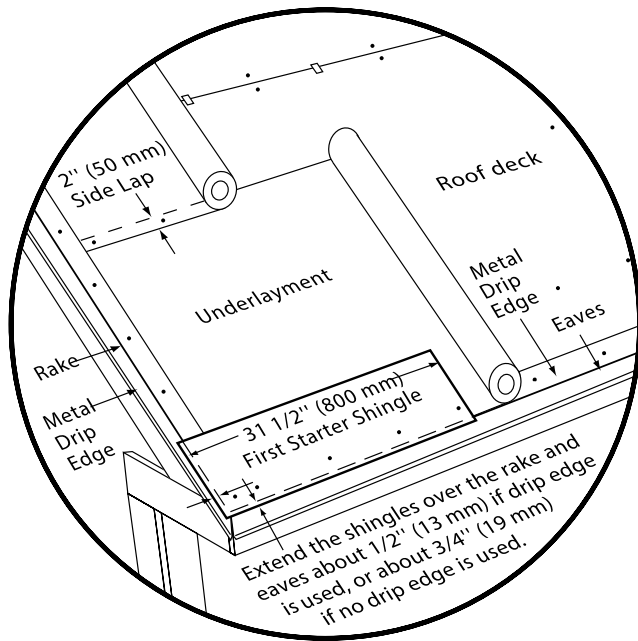

Figure 17-8: Standard slope underlayment and starter drip edge details.

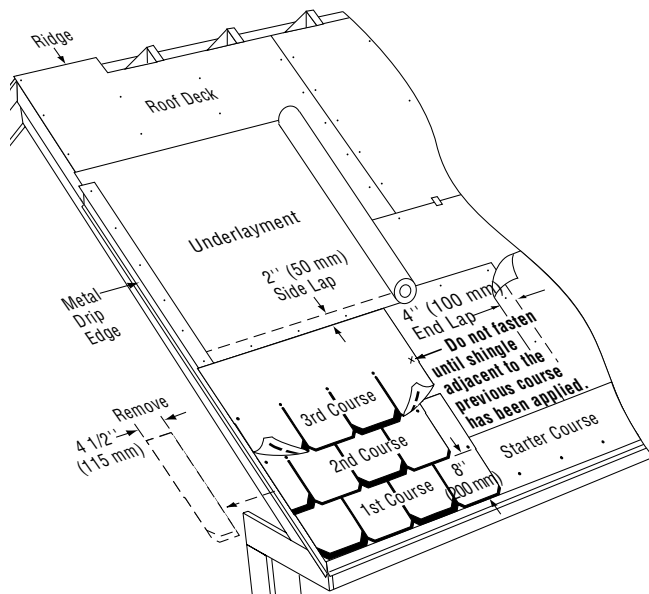

Figure 17-9: Applying the first 3 courses on a standard slope.

**2ND COURSE:** Cut 4-1/2" off the left end of a shingle. Apply the remaining larger piece over the first-course shingle, flush with the left edge and leaving 8" of the first course exposed. Snap chalk lines horizontally and vertically, as necessary (Figure 17-9). Be sure to check for proper alignment.

### SUCCEEDING COURSES:

- ◆ Begin the application of succeeding courses by alternating the placement of full shingles, and shingles with 4-1/2" cut off the left edge, up the rake in a single column.
- ◆ Fasten each full shingle with four fasteners, leaving the right tab edge unfastened until later.
- ◆ Fasten each trimmed shingle (31-1/2") using five fasteners.

### COMPLETING COURSES:

- ◆ Across the roof, full shingles are to be butted against the right side of applied shingles in each course (Figure 17-10).
- ◆ Work up the roof from the eaves, one vertical column at a time, maintaining the 8" exposure.
- ◆ On alternating courses where the right-hand shingle end was purposely left unfastened, carefully lift the loose shingle end, so as not to cause damage by tearing or sharply bending, especially at the top of the cutout tab "keyway," and slip the next shingle underneath to butt the hidden shingle end.
- ◆ Apply all five fasteners to the newly placed shingle and one fastener to the free end of the shingle above it.
- ◆ On alternating courses where the new shingles butt against the visible shingle ends, initially apply only four fasteners, leaving the right end free.
- ◆ Repeat the above procedure one column at a time to complete the courses across the roof.

### INSTALLING VALLEYS:

- ◆ Open valleys are strongly recommended, but not required. Closed-cut and woven valleys while not recommended are acceptable if the shingles are applied without cracking, buckling, or damaging them when shaped into the valley.
- ◆ When installing an open valley, use 16 oz. copper flashing at a minimum (or its equivalent) over WinterGuard or Grace Ice & Water Shield® Waterproofing Shingle Underlayment (or its equivalent). Preformed "W" style valleys are preferred (Figures 17-11 and 17-12).

## Here's a Tip...

Other tools used by contractors to cut these products include the 3-3/8" battery-operated power saw offered by several manufacturers with a carbide blade, asbestos shingle cutters, large heavy-duty paper cutters and sheet metal shears with replaceable blades.

Figure 17-10: "Vertical Racking" installation schematic.

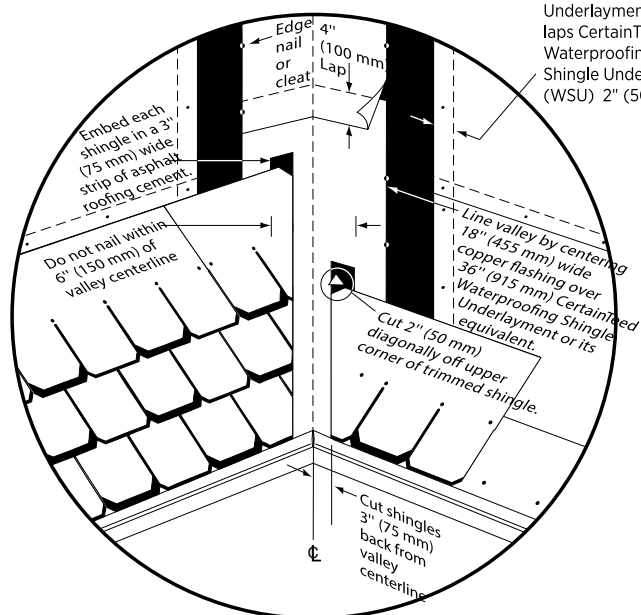
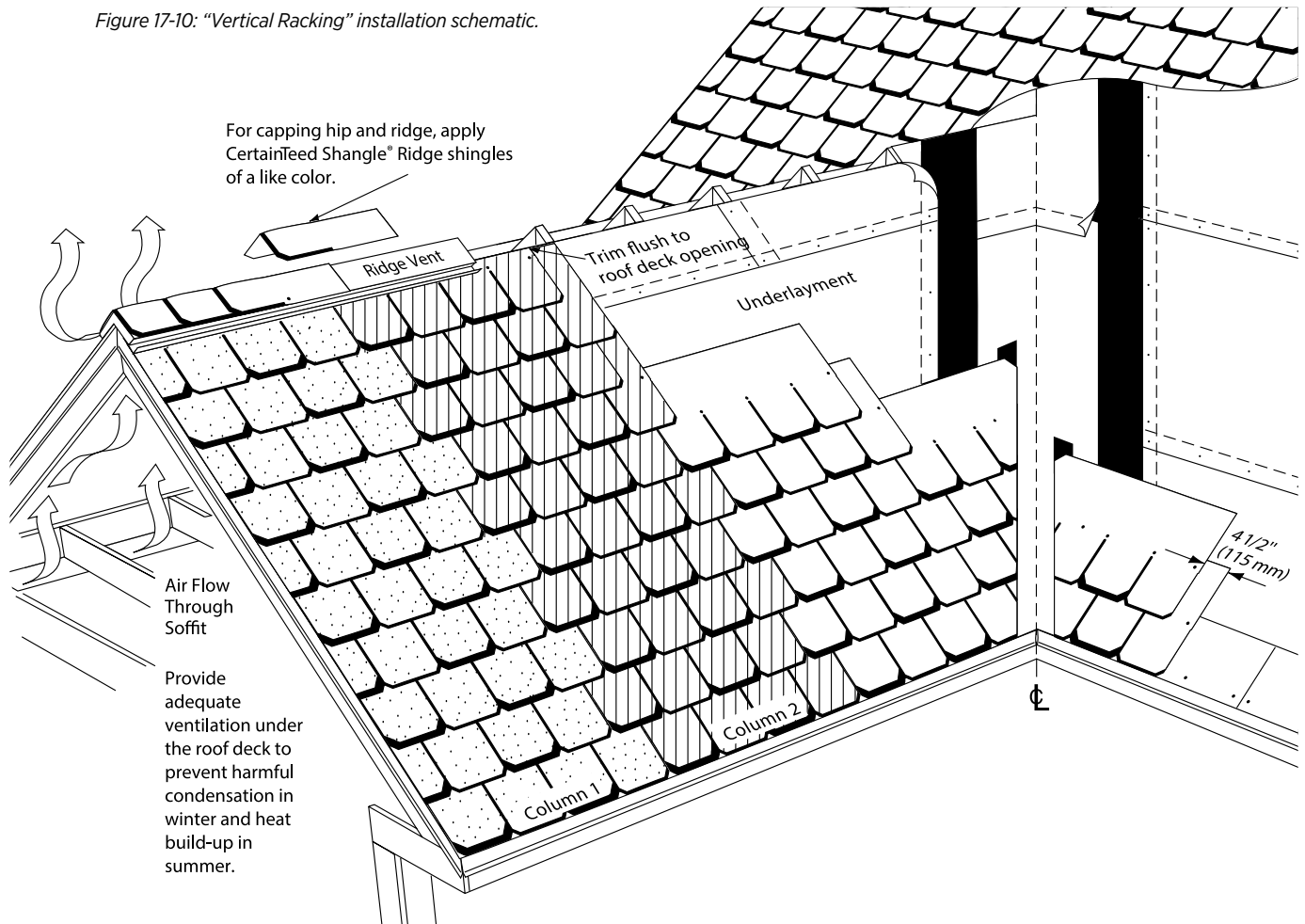

Figure 17-11 Valley installation for Grand Manor®.

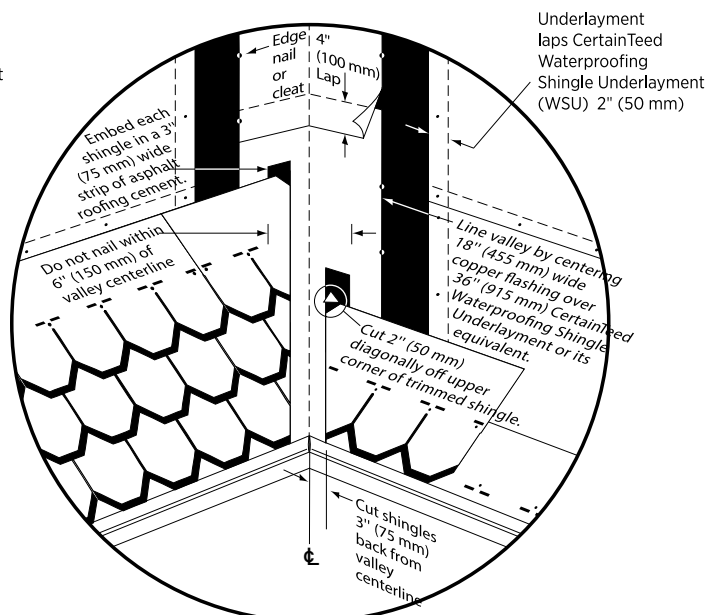

Figure 17-12: Valley installation for Carriage House®.

**INSTALLING STEP FLASHING:** Use 8" by 10" corrosion-resistant metal such as copper. For the first course of Carriage House® only, use a 8" by 12" piece of metal flashing (Figure 17-14).

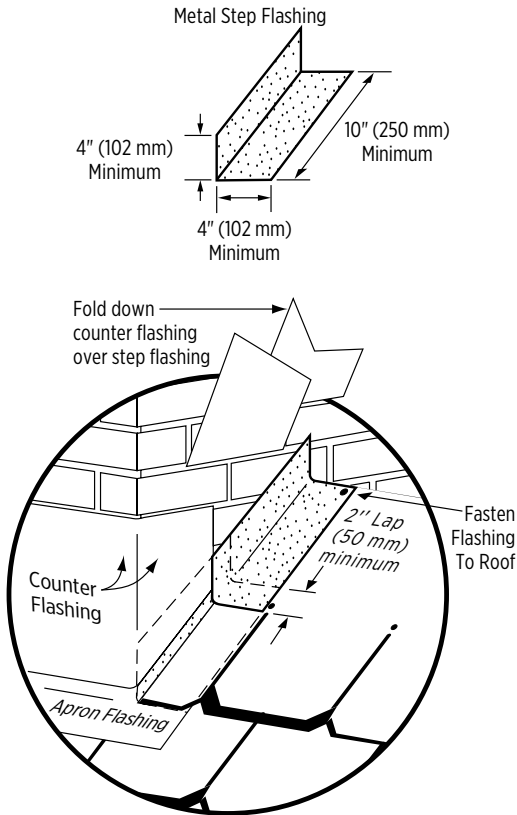

Figure 17-13: Metal step flashing for Grand Manor®.

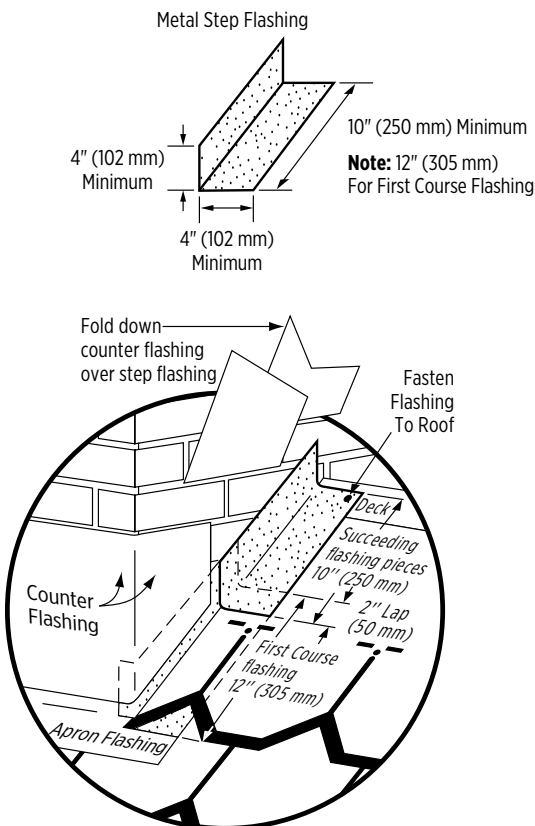

Figure 17-14: Metal step flashing for Carriage House®.

## CARRIAGE HOUSE ALTERNATIVE CLEAN-DECK APPLICATION METHOD

### SIX-COURSE, FOUR-AND-ONE-HALF INCH, STEPPED-OFF DIAGONAL METHOD (“FOUR-AND-ONE-HALF OFF, SIX UP”)

Because of the potential for “patterning” to appear, Grand Manor should not be installed using stepped-off methods. However, Carriage House may be installed using the “Six-Course, Four-and-One-Half Inch, Stepped-Off Diagonal Method.” This installation calls for the removal of a half tab for each step.

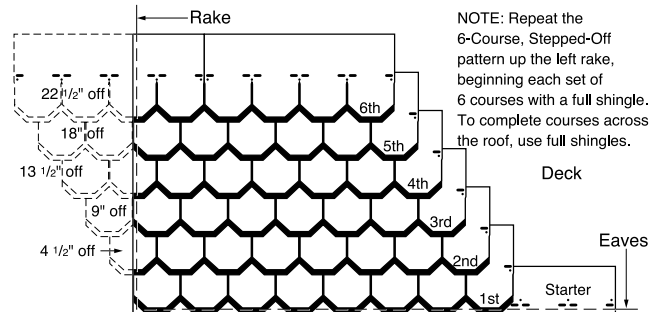

Figure 17-15: Four-and One-Half Off, Six Up (Carriage House).

#### STARTER COURSE:

1. The starter course will consist of Carriage House shingles from which the 8" lower portion has been removed. Cut 4½" off the length of the left side of the first starter strip and apply at lower left corner of the roof. This 31½" long starter strip should overhang rakes and eaves ½" when drip edge is used, or ¾" when no drip edge is used.
2. Locate fasteners in starter strip about 1½" up from the bottom edge, so they are centered under the first-course tabs. Continue with full 10" by 36" lengths along the eaves (Figure 17-15).

**1ST COURSE:** Apply a full shingle at the lower left corner of the roof, tabs flush with starter course (Figure 19-15).

#### 2ND THROUGH 6TH COURSES:

1. The second course is begun by cutting 4½" off the left end of a shingle, and applying this 31½" piece over the first-course shingle. Expose first course 8".
2. Each subsequent course, up to and including the sixth course, should consist of a shingle 4½" shorter than the previous course, ending with a 13½" piece on the sixth course. Expose each course 8". This method will establish the 4½" stepped-off pattern.
3. Install full 18" by 36" shingles against these six courses.

**Succeeding courses:** Repeat the six-course, 4½" stepped-off pattern up the left rake, beginning each set of six courses with a full shingle. To complete courses across the roof, use full shingles. All shingles on the finished roof must be applied with five fasteners.

## Here's a Tip...

Use Grand Manor® as the first course for a Carriage House® roof to achieve a straight edge at the eaves.

## TWO ROOF-OVER METHODS

### DECK LOADING

The job supervisor should always check local building codes regarding maximum deck loading limits. In particular, someone must determine that the existing roof frame can support workers and the additional weight of a new roof using these super heavy-weight shingles over the old shingle roof. Keep in mind that Grand Manor weighs 430 pounds per square and Carriage House weighs 350 pounds per square. In many locations, it's also important to figure in the weight of a snow load. In no case should you put these products over another heavyweight roof, or over a roof that already has two or more layers of shingles. The combined weight of the roofs, more than likely, will be too much weight for most frame buildings.

### PREPARING THE ROOF SURFACE FOR REROOFING

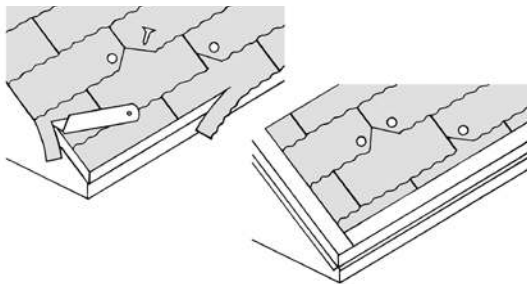

Figure 17-16: Preparing an old roof for reroofing.

- ◆ Make the surface of the old roof as smooth as possible by replacing missing shingles. Split and nail flat all buckled, raised tabs and curling shingles. If Carriage House or Grand Manor shingles will be nested into the old shingles, review the Nesting/Cutback Method described later in this chapter.
- ◆ It's a good idea to cut old shingles back flush to the rakes and eaves.
- ◆ We suggest that you apply corrosion-resistant drip edge along the rakes and eaves, covering the edges of the old shingles. This will provide a uniform straight edge that will help prevent water seepage under the shingle edges.

### (1) BRIDGING METHOD

**INSTALLATION:** The "bridging" method (direct application over the smoothed, old roof surface) is acceptable for Grand Manor only. Essentially, follow the standard application method for Grand Manor, but do not use underlayment. However, the Nesting/Cutback Method is preferred over this method when reroofing because nested shingles shed water best and look better.

When reroofing with the bridging method over existing shingles use the approved application method as described in the Clean-Deck Application Method earlier in this chapter.

### (2) NESTING/CUTBACK TECHNIQUE

When reroofing with Carriage House we strongly recommend that this method be used to avoid slumps and raised edges caused by "bridging" shingles. It may also be used when applying Grand Manor.

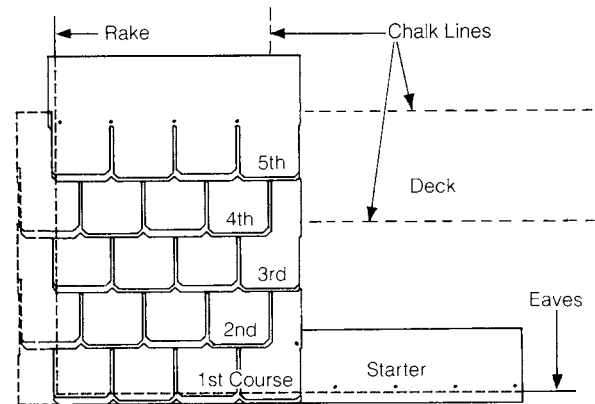

Figure 17-17: The "Nesting/Cutback Method."

To use the Nesting/Cutback Method (Figure 17-17), simply cut 3" off the leading edge of all old shingles when they are lapped less than 2½" by the new shingle. This permits a flat nested application that avoids lifted edges and slumps.

In addition, follow all the standard application and nesting instructions. Do not apply underlayment.

## HIPS AND RIDGES

Apply Shingle Ridge® shingles to hips and ridges.

1. Each shingle is a 12" by 18", color-coordinated, pre-assembled, double-layered product. Exposure is 8".
2. Apply Grand Manor or Carriage House up to the hip or ridge from both sides and trim flush. Allow for adequate coverage by making sure the last course of shingles will not be exposed more than 8" when the cap shingles are applied.
3. To assist with proper alignment when ridge vents aren't used, snap a chalk line parallel to the hip or ridge along the line where the side edges of the cap should be.
4. If possible, try to start at the end of the ridge opposite to where the prevailing wind strikes the house. This will give the wind and rain less of a chance of getting underneath the cap. As for the hip, begin by installing the cap at the bottom and work your way up.
5. Before nailing, be sure to remove the protective tape from the sealant between the cap's two layers (Figure 17-18).

## Here's a Tip...

When applying caps, gently form them over the ridge to avoid cracking or granule loss. On very steep ridge lines, applying double caps will reduce the "sharpness" of the angle at the peak.

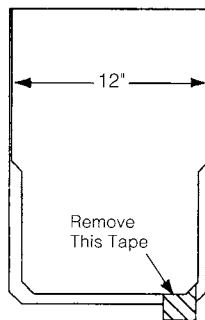

Figure 17-18: Shingle Ridge®.

- Bend the cap along the centerline of its longer dimension so that it forms into place over the hip or ridge.
- Fasten each cap with two fasteners (Figure 17-19). The fasteners must be  $\frac{1}{4}$ " long, or longer, so they penetrate either  $\frac{3}{4}$ " into the deck or completely through the deck, exposing at least  $\frac{1}{8}$ " of the tip of the nail. Expose 8" of the Accessory along the ridge or hip line and cover all fasteners.

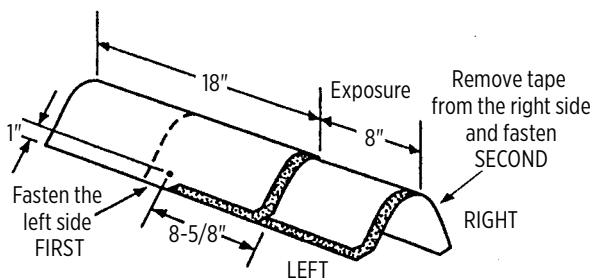

Figure 17-19: Installation of Shingle Ridge shingles on hips and ridges.

- If shingle-over ridge vents are being installed (Figure 17-20), they must match the 12" width dimensions of the hip and ridge caps. Be sure to follow the ridge vent manufacturer's instructions. To attach the cap shingles to the shingle-over ridge vent, use hot-dipped galvanized nails of sufficient length to penetrate  $\frac{3}{4}$ " into, or through, the deck.

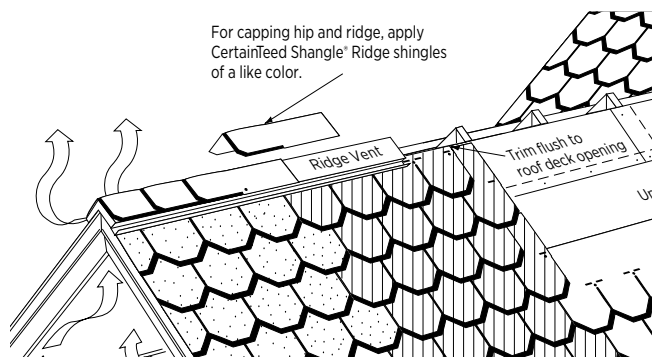
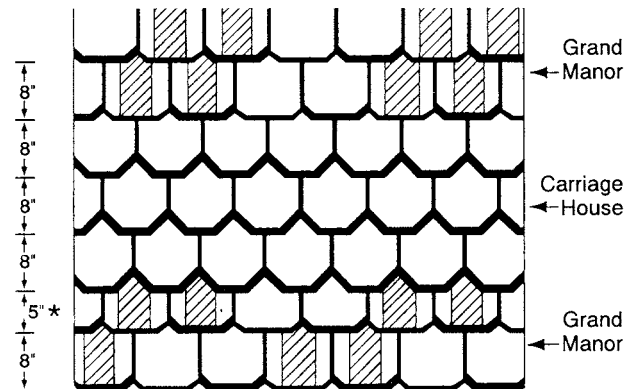

Figure 17-20: Installation of Shingle Ridge shingles on ridge vent.

## BLENDED APPLICATIONS

### BLENDING CARRIAGE HOUSE AND GRAND MANOR ON THE ROOF



\*5" transitional course used only when blending Carriage House over Grand Manor.

Figure 17-21: Blending Carriage House® with Grand Manor®.

**IMPORTANT:** Carriage House shingles can be blended into a Grand Manor roof to achieve a unique and distinctive appearance, much like the slate artisans did to make homes distinctive. Mixing of products on the roof to create a design is at the owner's discretion and risk, and CertainTeed will not be responsible for the aesthetics of the finished design.

Generally, covering  $\frac{1}{4}$  to  $\frac{1}{3}$  of the roof with Carriage House can offer an aesthetically appealing appearance. A common application method uses several courses of Carriage House in the middle of a Grand Manor roof (see Figure 17-21). Each course must consist of only one shingle type.

- The first course of Carriage House shingles to be applied over Grand Manor must expose the Grand Manor course only 5" to the weather. This will allow the proper color to show through the notched cutouts. Expose subsequent courses of Carriage House 8" to the weather. Hand seal the first course of Carriage House with four quarter-size spots of asphalt plastic cement (ASTM D4586, Type II) under each shingle.
- Expose the first course of Grand Manor applied over Carriage House (and all subsequent courses of Grand Manor) 8" to the weather except, of course, when another course of Carriage House shingles is begun (see Step 1).
- Follow all other standard application instructions found on the appropriate packages when applying shingles.

## SECTION 17 SELF-TEST

**17-1. A minimum of 5 nails are required for fastening each full shingle.**

- A. True.
- B. False.

**17-2. High-performance starter is used with both Grand Manor® and Carriage House®.**

- A. True.
- B. False.

**17-3. The 4-1/2" Vertical Racking Method is approved for Grand Manor® and Carriage House®.**

- A. True.
- B. False.

**17-4. Carriage House may be installed using a diagonally stepped-off method but Grand Manor may not.**

- A. True.
- B. False.

**17-5. The type of valley recommended by CertainTeed, when installing Grand Manor or Carriage House is an open valley using preformed "w" style flashing material.**

- A. True.
- B. False.

**17-6. Shangle Ridge® cap shingles are designed for use with Grand Manor and Carriage House.**

- A. True.
- B. False.

*Test on-line @ [www.certainteed.com/samtest](http://www.certainteed.com/samtest)*