



Noise Control For Buildings

Guidelines for
Acoustical Problem Solving

“The technology of noise control both inside & outside buildings is well developed today.

The problem is that it is too seldom used.”

Robert B. Newman, Architect

CONTENTS

Introduction

The Problem of Noise in the Built Environment.....	4
There are Solutions.....	4
Who is CertainTeed?.....	5
Some Historical Milestones	6

Fundamentals of acoustics

Properties of Sound: Frequency, Wavelength, Amplitude.....	8, 9
How We Measure Sound Levels; How We Hear Sound	10
Other Sound Properties: Propagation	10, 11
How Much Sound is Acceptable? Noise Criteria (NC) Values	11
Sound Paths, Airborne and Structureborne	12

Airborne sound transmission

Sound Transmission Loss, Sound Transmission Class (STC).....	14
Lightweight Double-Leaf Walls	14
Insulation density and STC.....	17
Sound Transmission Loss and Noise Control	17
Sound Flanking Paths.....	17

Structureborne sound transmission

Impact Insulation Class (IIC).....	18
------------------------------------	----

Sound absorption

Definition; Measurement of Sound Absorption.....	20
Properties of Sound Absorbers.....	21
Sound Absorption and Noise Control.....	21
Sound Level Reduction Calculation.....	22
Reverberation Time Calculation	23

Principles of SPR noise control

Controlling Noise at the Source	24
Controlling Noise Along its Path.....	24
Controlling Noise at the Receiver.....	25
Temporary Sound Control	25
Three Steps to Noise Control Solutions	25

HVAC noise control

Fiberglass Duct Liner.....	26
Fiberglass Duct Board.....	26

Residential sound control practices

The Right Insulation Material.....	28
Five Noise Control Mistakes to Avoid	29

Building insulation assemblies

Sound Absorption Coefficients, Typical Building Materials.....	30
Sound Absorption Coefficients, CertainTeed Fiberglass Insulations	31, 32
Sound Transmission Loss Values, Common Building Materials.....	33
Sound Transmission Loss Values, Wood Stud Wall Assemblies	34, 35, 36
Sound Transmission Loss Values, Steel Stud Wall Assemblies.....	37, 38
Sound Transmission Loss Values, Wood Joist Floor/Ceiling Assemblies.....	39

Appendix

Acoustical Guide Specification.....	40, 41
Glossary of Terms	41, 42
Worksheet for Calculation of Room Reverberation Level and Time.....	43
Fire Rated Wall Assemblies.....	44, 45

NOTE: In preparing this manual, CertainTeed Corporation has taken care to include accurately all information relevant to basic application of noise control products and systems. However, because of the many variables that may arise in construction technology, the importance of correct installation of acoustical materials, and other factors including use and occupancy, no liability can be assumed for application of the principles and techniques contained herein. CertainTeed Corporation makes no warranty, express or implied or regarding merchantability or fitness for a particular purpose, in connection with the information supplied herein.

Introduction

The Problem of Noise in the Built Environment

It's a noisy world. Twenty-four hours a day, seven days a week, we are exposed to sounds we do not want, need, or benefit from. There are few places on the planet where in our daily lives we are free from unwanted sounds.

Noise from many outdoor sources assails our hearing as it invades our homes and workplaces: traffic, aircraft, barking dogs, neighbors' voices. Noise within the workplace — from office machines, telephones, ventilating systems, unwanted conversation in the next cubicle — distracts us from our work and makes us less productive.

Noise from within the home — from appliances, upstairs footsteps, TV sound traveling from room to room — keeps our homes from being the restful refuges they ought to be. Noise in the classroom impedes the learning process and threatens our children's educational experience.

Noise can frustrate and impede speech communication. It can imperil us as we walk or drive city streets. It can be a physical health hazard as well: Exposure to high noise levels can cause permanent hearing loss.

In short: Noise is unwanted sound.

There are Solutions

We don't need to suffer the distracting, fatiguing, and unhealthful consequences of noise. There are practical and economical solutions to almost all noise problems in the built environment.

To approach the solution to any specific noise problem, we need to:

1. Understand the basic physics of acoustics and how noise — unwanted sound — is produced, how it propagates, and how it is controlled.
2. Learn the basics of noise control, and how to approach the problem from three standpoints: the source of noise, the path it travels, and the point of reception.
3. Become familiar with, and discover how to apply in both new and remodeling construction, the acoustical fiberglass insulation products and systems that control noise — products that contribute to the creation of acoustically comfortable, productive, and healthful environments.

That's what architects, engineers, contractors, and building owners — anyone concerned with solving noise control problems in all types of buildings — will find in this manual. It includes information on how to solve specific noise control problems using CertainTeed Insulation products and systems. These products are made of the most versatile, cost-effective, safe, and easily applied sound control material yet devised: fiberglass.

Who is CertainTeed?

CertainTeed is a member of the Saint-Gobain family, a recognized global leader in high performance building materials technology and the world's preeminent manufacturer of fiberglass insulation products. CertainTeed's Insulation Group manufactures and markets a complete line of fiberglass thermal and acoustical insulation products which include:

- CertaPro™ insulation products for commercial construction.
- CertainTeed Building Insulation for use in residential construction.
- CertainTeed HVAC products for commercial and residential air duct systems.

Through the responsible development of innovative and sustainable building products, CertainTeed has helped shape the building products industry for more than 100 years. Founded in 1904 as General Roofing Manufacturing Company, the firm's slogan "Quality Made Certain, Satisfaction Guaranteed," quickly inspired the name CertainTeed. Today, CertainTeed is North America's leading brand of exterior and interior building products, including roofing, siding, windows, fence, decking, railing, trim, insulation, gypsum, and ceilings. Through the responsible development of innovative and sustainable building products, CertainTeed has helped shape the building products industry for more than 100 years. Founded in 1904 as General Roofing Manufacturing Company, the firm's slogan "Quality Made Certain, Satisfaction Guaranteed," quickly inspired the name CertainTeed. Today, CertainTeed is North America's leading brand of

exterior and interior building products, including roofing, siding, windows, fence, decking, railing, trim, insulation, gypsum, and ceilings.

CertainTeed's manufacturing plants are registered to ISO 9001-2000 standards. CertainTeed's commitment to quality and the environment has ensured the certification of the Athens, Chowchilla and Kansas City plants to ISO 9001 and ISO 14001 Quality and Environmental Management System standards.

CertainTeed fiberglass insulation products are also certified by GREENGUARD for low emissions of VOCs, formaldehyde, and other particulates.

CertainTeed acoustical insulation products provide another important benefit in residential and commercial construction: energy conservation. The high thermal efficiency of our fiberglass insulation products means less energy is required to heat and cool our buildings.

If you need assistance in solving noise control problems through application of CertainTeed acoustical products, please contact us at 1-800-233-8990. More information on CertainTeed's building products and systems is also available at our website, www.certainteed.com/insulation.



Some Historical Milestones

Take a seat — any seat — in the great semicircular outdoor amphitheater at Epidaurus, in Greece. Place a player at the center of the performance space. Listen closely: You can almost hear a whisper from as far as 200 feet away. The Greeks knew enough about how sound propagates to have achieved this astonishing acoustical success as long ago as the 5th century B.C.

The Romans could design interiors with ideal acoustics. Stand against the wall in Rome's Pantheon and your breathing can be heard by someone standing opposite you across the great hemispherical space. The cathedral builders of Europe's Middle Ages knew how to build for maximum acoustical effect. Sir Christopher Wren and other 18th century architects discovered how to design concert halls to optimize the listening experience at any seat.

Still, little was known about the physical science and measurement of sound until Sir Isaac Newton. He demonstrated that sound waves travel through any medium — solid, liquid, or gaseous — and that the speed with which they propagate depends upon the elasticity and density of the medium.

In 1866, the fundamental nature of sound waves was vividly demonstrated by a German scientist, Charles Kundt. He placed powder in a clear glass tube plugged at one end and having a source of sound at the other. When the sound source was turned on, the powder collected in little piles spaced at regular intervals along the tube. Changing the pitch of the sound changed the spacing of the piles of powder.

What was happening? The sound waves were entering the tube, being reflected by the plug, and alternately compressing and rarefying the air in the tube to form a standing wave. The powder was collecting at the points of zero sound pressure (Figure 1) — those points where the minute positive and negative pressure components of the sound wave cancelled each other out.

Kundt's tube made it possible to determine the wavelength of sounds at varying frequencies — the distance between successive peaks of a sound wave — by measuring the distance at a given frequency between the piles of powder.

Today's precision electronic instruments tell us that, in 68°F (20°C) air, the speed of sound at normal atmospheric pressure is 1,130 feet per second. On the basis of his experiment, Kundt calculated the speed of sound in air to be 1,125 feet per second. Not bad for a primitive 19th century device!

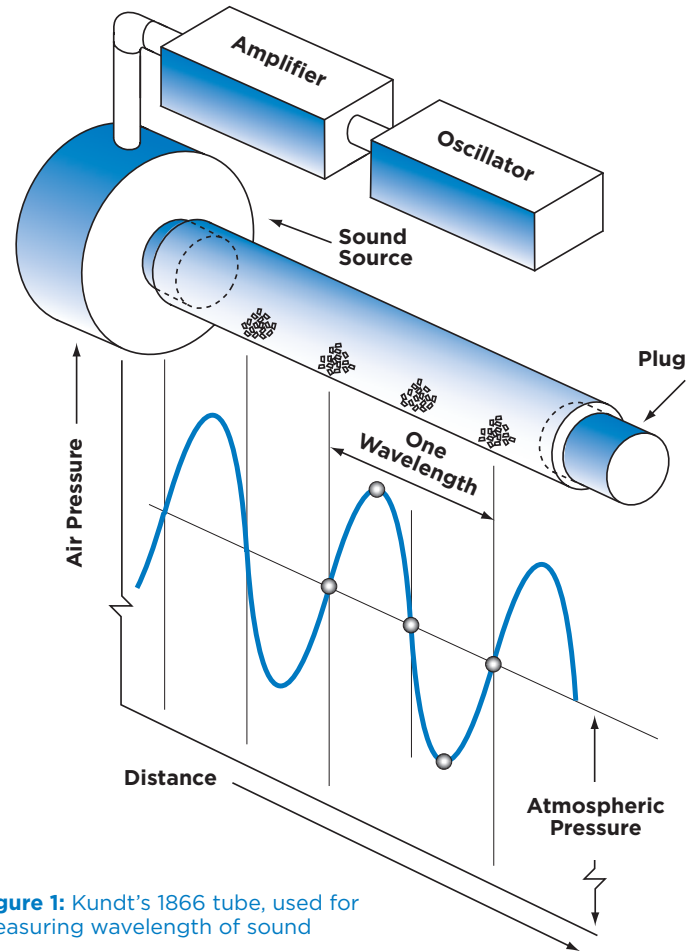

Figure 1: Kundt's 1866 tube, used for measuring wavelength of sound

“An essential ingredient for success in noise control is a desire to achieve noise control.”

David A Harris,
Building & Acoustical Consultant

Fundamentals of Acoustics

Properties of Sound

To control sound in today's built environment, we need to know a little about its fundamental properties such as:

- Frequency (pitch)
- Wavelength
- Amplitude (loudness)

Once these fundamental properties of sound or sound waves are understood, we can proceed to implement effective noise control measures.

Frequency (Pitch)

Sound is a form of mechanical energy transmitted by vibration of the molecules of whatever medium the sound is passing through. The speed of sound in air is approximately 1,130 feet per second. In steel it is approximately 16,360 feet per second, and in water 4,900 feet per second. The denser the medium, the faster sound travels in that medium. A pure sound wave of a single frequency takes the shape of a sine wave (Figure 2). The number of cycles per second made by a sound wave is termed its frequency. Frequency is expressed in Hertz (Hz). The sound we hear is usually radiated in all directions from a vibrating medium.

Most of the sounds we hear, however, are a combination of many different frequencies (Figure 3).

Healthy young human beings normally hear frequencies as low as about 20 Hz and as high as 20,000 Hz. At middle age this range decreases to about 70 to 14,000 Hz. By comparison, the frequency range of a piano keyboard is from 31.5 Hz to 8,000 Hz. Because human hearing is most acute to frequencies in the region of 4000 Hz, we hear a 4000 Hz tone as being louder than a tone at some other frequency, even though the acoustical energy, or sound power, may be the same.

For purposes of noise control, acousticians divide the audible sound spectrum into octaves, just as the piano keyboard does. These divisions are expressed as octave bands and are referred to by

their center frequencies. Each center frequency is twice that of the one before it. When a more detailed sound spectrum is required, octave bands are further divided into thirds (Table 1).

Wavelength

The wavelength of a sound wave is the distance between the start and end of a sound wave cycle or the distance between two successive sound wave pressure peaks

(Figure 4). Numerically, it is equal to the speed of sound in the material such as air divided by the frequency of the sound wave.

For example:

The wavelength of a 100 Hz tone at room temperature is 1130 ft/sec divided by 100 Hz which is equal to 11.3 ft.

OCTAVE BAND CENTER FREQUENCIES, HZ	BAND LIMITS
32	22-45
63	45-89
125	89-178
250	178-355
500	354-709
1000	707-1414
2000	1411-2822
4000	2815-5630
8000	5617-11234

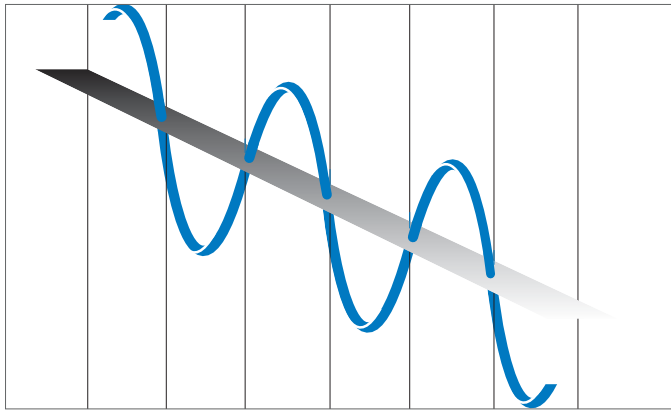

Figure 2: Pure sound wave, as from a tuning fork

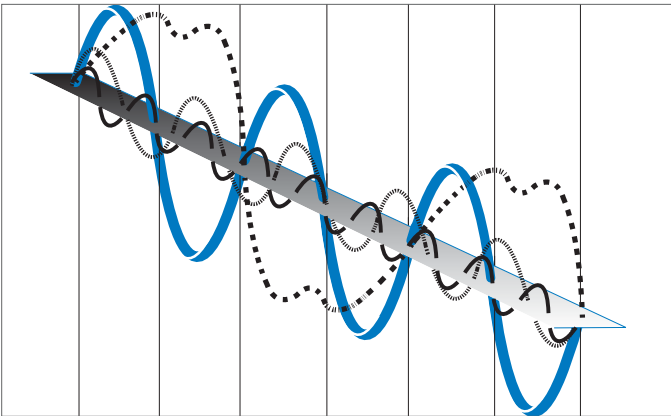

Figure 3: Most sounds we hear are more complex

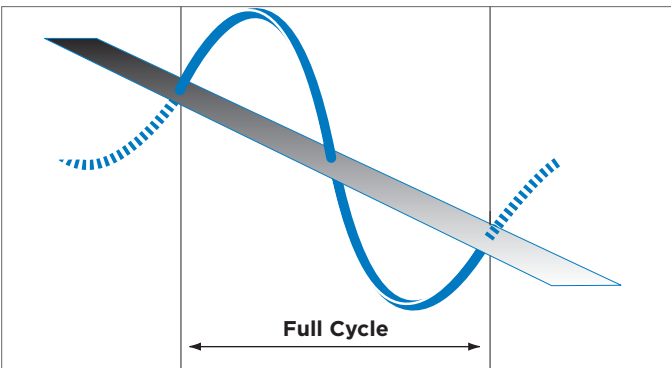

Figure 4: Wavelength: the distance from start to end of a cycle

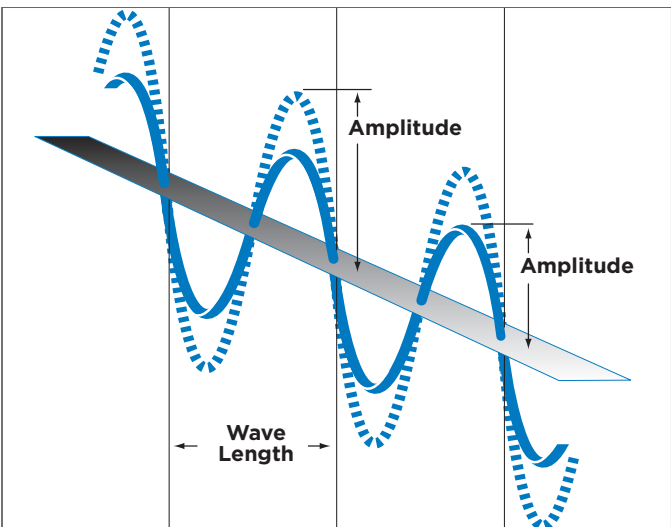

Figure 5: Two sounds of equal frequency and differing amplitude

Amplitude (Loudness)

The amplitude or loudness of a sound wave is expressed by its sound pressure level. Sounds having the same wavelength (equal frequency) may have differing loudness (Figure 5).

Because the sound pressure of a sound wave may vary over a wide range — a change in magnitude of ten million to one — sound pressure is expressed using a logarithmic scale. This is the basis of the decibel scale, which compresses the range of sound pressure into a scale from 0 to 150. The decibel (dB) is not an actual measure of amplitude or loudness, but expresses the ratio between a given sound pressure and a reference sound pressure.

This relationship is expressed by the following equation:

$$(L_p) = 10 \log (P/Pre)^2$$

Where: L_p is the Sound Pressure Level

P is the Sound Pressure (Pa)

Pre is the sound pressure at the threshold of hearing (0.00002 Pa)

Table 2 gives sound pressure levels in dB and sound pressure in Pascal's (Pa) for various sounds within the human ear's hearing range. Note that, because the decibel scale is logarithmic, a sound pressure level of 80 dB is 1,000 times that of the sound pressure level at 40 dB — not just three times.

SOURCE OF NOISE	SOUND PRESSURE LEVEL, DB	SOUND PRESSURE, PA
Threshold of pain	120	20
Loud rock music	110	6.3
Metalworking plant	100	2
Average street noise	70	0.06
Average office noise	60	0.02
Quiet residential street	50	0.006
Very quiet home radio	40	0.002
Inside a country home	30	0.0006
Threshold of hearing	10	0.00006

Table 2: Sound pressure levels for various sounds

“Excessive noise in the classroom is an unacceptable barrier to learning which our society can ill afford.”

Lou Sutherland, Acoustical Consultant

How We Measure Sound Levels

A sound level meter (Figure 6) is used to measure sound pressure levels. Since the human ear is not equally sensitive to all sound levels, most sound level meters have internal frequency weighting systems to give readings equivalent to how we hear sound levels. These



Figure 6: Sound level meter

weighting systems are designated as A, B, and C weightings. Today only the A and C weightings are used. The A weighting is used most frequently because it yields sound measurements that most closely reflect how we actually hear. These response curves, which plot the relative response in dB against frequency in Hz, are shown in Figure 7.

Continuous exposure to A-weighted sound levels over 85 dB can cause permanent hearing loss. It is possible, under perfect listening conditions, for the human ear to detect changes in sound level as little as 1 dB. However, a change of at least 3 dB is normally required in order to be detectable. A 10 dB change in sound level is commonly heard as twice as loud, or one-half as loud.

A noise control problem may involve multiple sources. For example, two motors may be located at the source, one operating steadily and the other intermittently. However, the total sound pressure level when both motors are operating will not be the total number of decibels produced by each, because decibels are not additive. The total sound pressure level when both motors are operating can be easily determined as shown in Table 3.

IF THE DIFFERENCE BETWEEN THE TWO SOUND LEVELS IS:	ADD TO THE HIGHER SOUND LEVEL:
1 dB or less	3 dB
2 or 3 dB	2 dB
4 to 9 dB	1 dB
10 dB or greater	0 dB

Table 3: Adding dB to sound levels for second source

For example: If both motors are emitting 65 dB, when the second motor is operating the total sound pressure level will be $65 + 3 = 68$ dB. If one motor is emitting 65 dB and the other 70 dB, when both motors are operating the total sound pressure level will be $70 + 1 = 71$ dB.

If one motor is emitting 65 dB and the other 75 dB, when both motors are operating the total sound pressure level will remain at 75 dB, the sound level of the noisier motor.

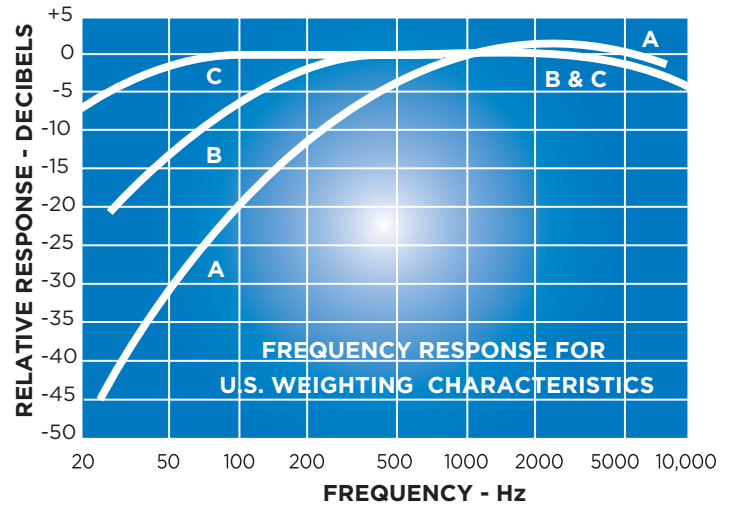

Figure 7: A, B, and C frequency weighting curves

How We Hear Sound

As noted, sounds at some frequencies are perceived as louder to the human ear than sounds at certain other frequencies, even though they may actually have the same dB level. This demonstrates two interesting facts about how we hear:

1. The lower the frequency, the less sensitive the human ear is to it, especially sounds below 100 Hz.
2. The human ear is most sensitive to sounds around 4000 Hz.

Other Sound Properties

How sound fluctuates with time can be an important factor in noise control. This fluctuation with time can take one of three forms:

1. Steady sound changing little or not at all with time, such as the noise produced by a fan. We can become so accustomed to steady sound that we almost cease to hear it after a while, unless it is too loud to ignore.
2. Intermittent sound, occurring more or less randomly with time, such as a low flying airplane. Intermittent sounds can be more annoying than steady sounds because they repeatedly interrupt periods of relative quiet.
3. Sudden or impulsive sound, such as a gunshot, occurring unexpectedly and usually startling or even frightening the listener. If loud enough, such sounds can cause hearing loss.

“All materials are acoustical materials. Some are better than others.”

Propagation

Sound waves radiate directly and spherically outward from the source (Figure 8), decreasing in amplitude with the square of the distance from the source. The sound pressure level decreases 6 dB for each doubling of distance. If, however, the sound source is indoors, reflected or reverberant sound will add to the overall sound level within the room to make up for the decreasing direct sound energy.

How Much Background Sound is Acceptable?

We have defined noise as unwanted sound. Whether we are in our homes, workplaces, or outdoors, we will almost certainly be exposed to a certain level of background or ambient sound. Before we can begin to solve a noise control problem, we must determine how much background sound is acceptable. We can never create, nor do we really want, a completely sound-free environment. We do not wish to live in a world without sound.

The question becomes: at what level does background sound become too loud for a particular situation? A moderate level of background sound can be helpful when it prevents private conversation in the home or office from being overheard by nearby listeners, yet doesn't make it difficult for those conversing to be heard by each other. Very low level background sound can even contribute to sleep or rest when not interrupted by intermittent or sudden loud noises. In some public places, a somewhat higher level of background sound may be acceptable. Other places, such as auditoriums and concert halls where very low background sound levels are required, present particular problems in sound control.

Noise Criteria (NC) curves are one of several systems used to establish allowable sound levels for various interior spaces. NC curves are shaped to compensate for the human ear's response to loudness at octave band center frequencies and the speech interference properties of noise. The NC curves are shown in Figure 9. Recommended NC sound levels for different spaces are shown in Table 4, page 12. Among other systems one may encounter are RC (room criteria) curves, Free Field Loudness contours for pure tones, and Equal Loudness contours for random noise.

Detailed guidelines for determining allowable sound levels can be found in Chapter 47 of the ASHRAE Handbook — "Sound and Vibration Control."

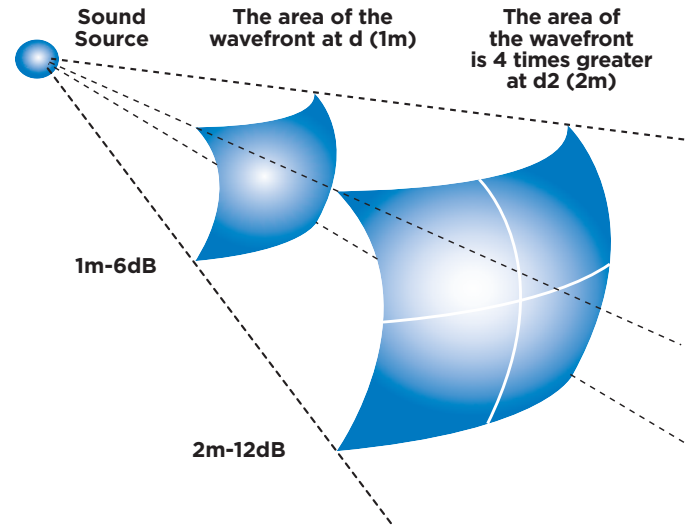

Figure 8: Direct sound energy decreases with the square of the distance from the source

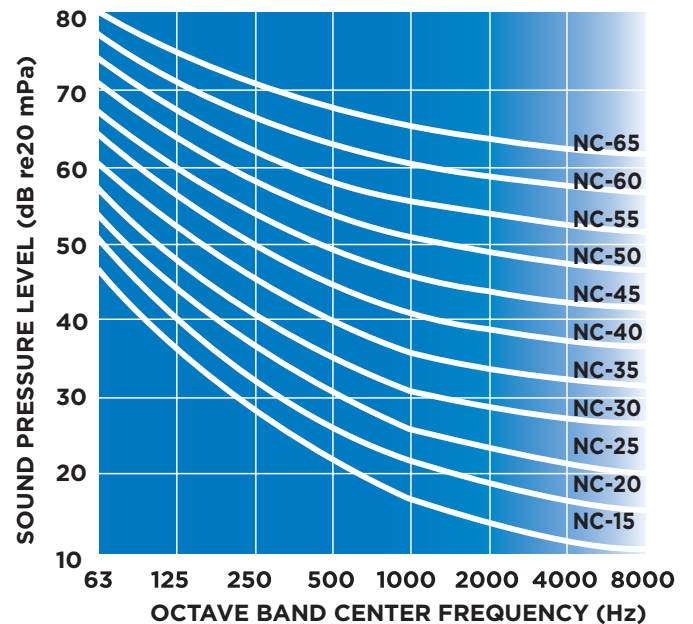

Figure 9: Noise criteria curves for octave band center frequencies from 63 Hz to 8000 Hz.

TYPE OF SPACE	ACOUSTICAL CONSIDERATIONS	NC VALUE
Concert and recital halls	Listening to both loud and faint sounds	10 - 20
Broadcast and recording studios	Distant microphone pick-up	15 - 20
Broadcast, television, and recording studios	Close microphone pick-up	20 - 25
Large auditoriums, theaters, churches	Listening to speech and music	20 - 25
Small auditoriums, theaters, churches	Listening to speech and music	25 - 30
Meeting, conference, and classrooms	Clear speech communication among a group	25 - 30
Bedrooms, apartments, hotels, motels	Clear conversation with speech privacy	25 - 35
Living rooms and family rooms	Clear conversation among a small group	35 - 45
Large offices, reception areas, retail shops	Clear conversation with speech privacy	30 - 35
Lobbies, engineering rooms, secretarial areas	Clear speech communication	40 - 45
Kitchens, laundries, laboratories	Clear speech communication	40 - 45
Light maintenance shops, equipment rooms	Clear speech communication	46 - 60

Table 4: Recommended noise criteria range for various interior spaces.

Sound Paths

Sound waves can travel through any media — air, water, wood, masonry, or metal. Depending on the media through which it travels, sound is either airborne or structureborne.

Airborne Sound

Airborne sound radiates from a source directly into and travels through the air. The sound of traffic passing our homes, the sound of music or voices from the next room or office, the noise from low flying aircraft — all travel to our ears as airborne sound.

Structureborne Sound

Structureborne sound travels through solid materials usually in direct mechanical contact with the sound source, or from an impact on that material. Examples are footsteps or objects falling on the floor upstairs, a knock at the door, or vibration from loud speakers on the floor. All structureborne sound must eventually become airborne sound in order for us to hear it. We can only feel structureborne sound as vibrations in a material. In most noise control situations, both airborne and structureborne sound must be considered.

Three Ways to Control Noise

There are only three basic ways to attenuate or reduce sound, whether at the source, at the listener's location, or along the path it travels from the source to the receiver:

1. Replace the sound source with a quieter one.
2. Block the sound with a solid, heavy material that resists the transmission of sound waves.
3. Absorb the sound with a light, porous material that soaks up sound waves.

These three ways to control sound are discussed in more detail in the subsequent sections.

“There’s a good probability that, if you can’t see the noise source, you won’t hear it.”

Robert Coffeen, Acoustical Consultant



Airborne Sound Transmission

Airborne Sound Transmission Loss

Airborne sound transmission loss is a measure of the degree to which a material or construction can block or reduce transmission of sound from one area to another.

All materials block or attenuate sound energy to a degree — heavy, impervious materials more effectively than light, porous ones. Since today's building technology depends to a great extent on light, flexible products like gypsum board and lightweight steel framing, the challenge is to utilize these materials in designing assemblies that provide optimum acoustical performance yet do not greatly increase the weight and mass of the structure.

Measuring Sound Transmission Loss

The degree to which a material or construction is effective at blocking airborne sound is expressed as its sound transmission loss (STL) value. Sound transmission loss values are measured at each one-third octave band frequency from 125 to 4000 Hz and are expressed in dB. STL values are determined and measured in accordance with ASTM Standard E90, Standard Test Method for Laboratory Measurement of Airborne Sound Transmission Loss of Building Partitions and Elements. From the sound transmission loss values, a single number rating called the sound transmission class (STC) is determined using ASTM Standard E413, Classification for Rating Sound Insulation.

The values below are based on a typical A-weighted background noise level of 30 dB and are based on multiples of five. Constructions with STC values within 1 or 2 points of what is required or specified should be considered acceptable as construction and test laboratory variations often exceed 2 or more STC points.

Lightweight Double-Leaf Walls

One of the most effective ways to block or reduce the transmission of sound from one room to another is to build a double-leaf wall. A double-leaf wall or sound transmission loss barrier is any wall with two faces separated by studs. Because of their construction, most double-leaf walls weigh less than solid walls with the same or comparable sound transmission loss values. For this reason, they are called lightweight walls. We describe double-leaf walls as mass/spring/mass walls because they have two masses (faces) separated by air or studs (springs).

The sound transmission loss or STC values of a lightweight wall can be increased as much as 10 STC points by adding acoustical insulation to the stud cavity of the wall. The acoustical insulation changes the spring properties of the mass/spring/mass composition of double-leaf walls. To get the most effectiveness out of the insulation, completely fill the stud cavity. Lightweight fiberglass insulation is an excellent acoustical insulation to use in double-leaf walls.

“Excessive noise in the classroom is an unacceptable barrier to learning which our society can ill afford.”

Lou Sutherland, Acoustical Consultant

STC RATING	SPEECH AUDIBILITY	EFFECTIVENESS
15 to 25	Normal speech easily understood	Poor
25 to 35	Loud speech easily heard, half of normal speech understood	Marginal
35 to 45	Half of loud speech understood, normal speech heard but not understood	Good
45 to 55	Loud speech faintly heard but not understood	Very Good
55 and higher	Loud speech usually not heard	Excellent

Table 5: Relationship between STC and noise control effectiveness

How STC Changes Affect Apparent Loudness

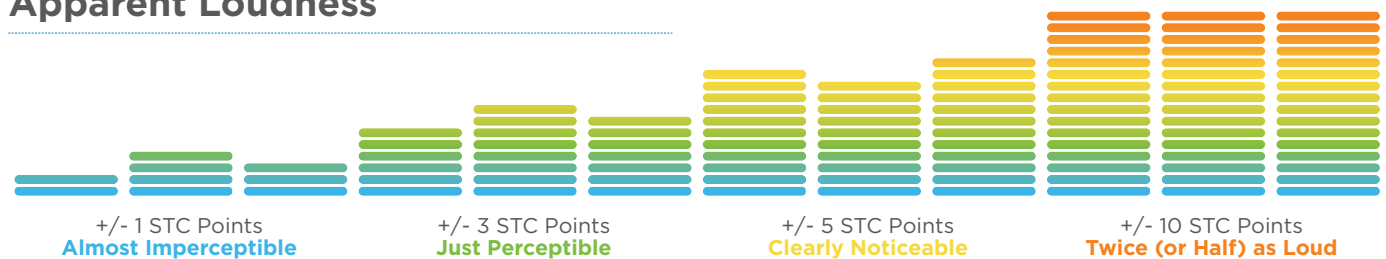

Sound Transmission Loss of Double-Leaf Walls

Sound striking a surface such as a wall causes that surface to vibrate, much like the diaphragm of a drum. The more massive the wall, the less the amplitude of vibration of the wall. This results in less noise being transmitted to the room on the other side of the wall. However, except in cases of exterior walls in large commercial buildings, it is rarely practical to rely on sheer mass to reduce the transmission of noise through a wall, especially when attempting to solve noise control problems within the building envelope.

In a conventional double-leaf wall — for example, one constructed of 1/2" gypsum wallboard and 2" x 4" wood studs on 16" centers — vibration is readily transmitted through the structure to the opposite side of the wall where it is heard as noise. The sound reducing property of the air space (the spring) is negated by the wood studs, which form a direct structural connection between the two wall surfaces (the masses). Installing 3-1/2" thick fiberglass insulation in the stud cavity increases the wall to STC 39 — not sufficient for uses requiring substantial noise reduction (Figure 10). (Without insulation, the STC rating drops to 35.) Increasing the mass of the insulated wall by adding a layer of gypsum wallboard on each side (Figure 11) raises the STC rating to 46. The increased mass decreases the

amplitude of vibration and, therefore, the noise level in the room on the other side of the wall.

Noise transmission through the wall can be greatly reduced by using resilient channels that eliminate direct mechanical connection of the gypsum wallboard to the wood studs

(Figure 12). Several resilient channel designs are available. With the resilient channels, the STC rating of the assembly is increased to 57, an acceptable value for most uses.

Double studs (Figure 13) allow doubling of the thickness of the fiberglass sound absorbing insulation in the wall cavity, as well as further diminishing direct mechanical connections from one wall surface to the other. The STC rating is now 66 — for a noise control effectiveness of “excellent.”

Many other possibilities exist for improving the STC ratings of double-leaf walls. These include the use of light-gauge steel studs that act as a softer spring between the two wall faces and give a much better increase in STC values when acoustical insulation is used in the stud cavity. Steel stud constructions and other wood stud constructions may be found in Section IX of this manual, along with their STC ratings.

Controlling Sound Through Building Assemblies

Steel Studs

Wood Studs

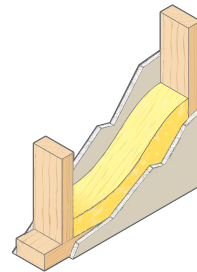
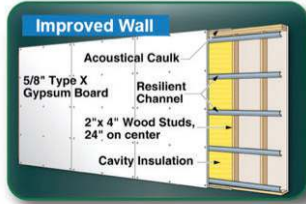
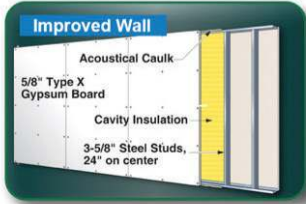

Figure 10: Conventional wood stud construction, single layer gypsum wallboard each side, 3-1/2" thick fiberglass insulation in wall cavity. STC: 39.

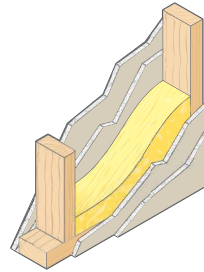

Figure 11: Conventional wood stud construction, double layer gypsum wallboard each side. Increased mass boosts STC rating to 55. See page 23.

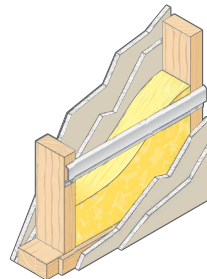

Figure 12: Resilient channels help minimize transmission of vibration through wall. STC rating of 57-59 considered acceptable for most uses. See page 24.

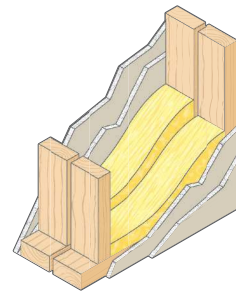
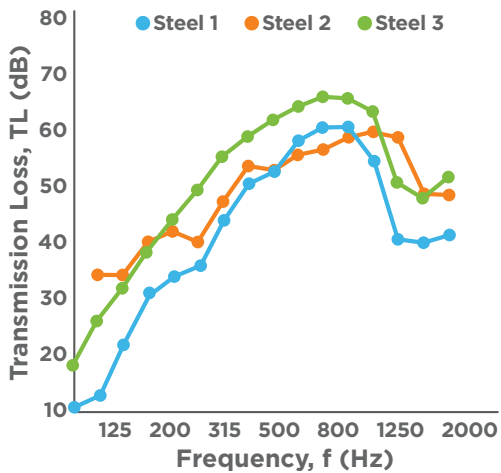

Figure 13: Double stud construction permits twice the thickness of fiberglass sound absorbing insulation. STC rating of 66-67 is excellent. See page 26.



Steel 1 - STC 38
Standard construction

Steel 2 - STC 50
Double layer of drywall, no cavity insulation, air sealed

Steel 3 - STC 50
Single layer of drywall, fiberglass insulation in cavity, air sealed (Most cost-effective system)

Airborne Sound Transmission Data Comparison of Wood Stud Walls

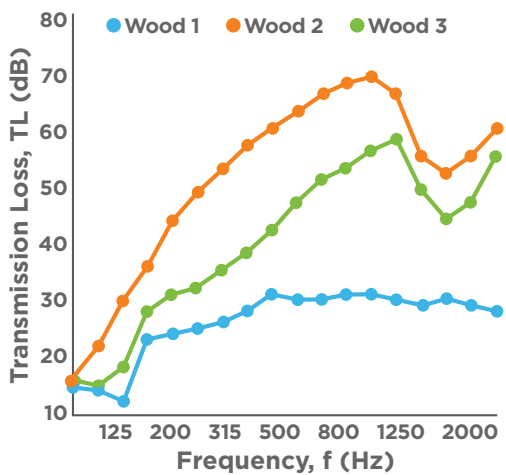

Wood 1 - STC 29
Standard construction

Wood 2 - STC 39
Standard construction adding cavity insulation and air seal

Wood 3 - STC 50
Standard construction adding cavity insulation, mounting drywall to resilient channel and air seal

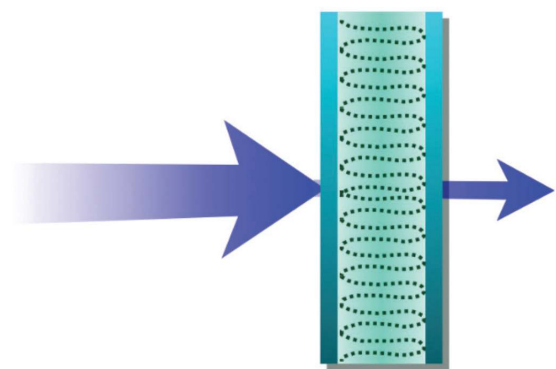

Sound Transmission Class (STC) measures airborne sound transmission. STC ratings are most often used to measure room-to-room acoustics. The higher the STC rating, the better.

Insulation Density and STC

It is incorrect to assume that higher density insulation within the mass/spring/mass wall system provides better sound transmission loss. Comparative tests conducted at nationally recognized acoustical laboratories have shown that increasing the density of the insulation while maintaining a constant thickness does not have a significant effect on the STC rating of the construction. It is incorrect to assume that heavy insulation in the core of a double leaf wall increases the STC because it adds weight to the wall. To increase the STC of a wall by adding weight, the weight must be added to the faces of the wall, not its core.

For this reason, mineral or rock wool insulation is not better than low-density fiberglass insulation. These same tests show that insulation thickness within the wall cavity is the most important property, and that complete filling of the cavity between wall surfaces provides the best wall performance.

Sound Transmission Loss and Noise Control

Other than reducing the noise level at the source, the best way to resolve noise problems is to enclose the source within a housing constructed of materials having high sound transmission loss values. The addition of an acoustically absorbent material to the inside of the enclosure reduces sound transmission. For example, Table 6 gives effective noise reduction values in dB for an enclosure made of 1/2" plywood, with and without a lining of 2" fiberglass insulation.

Enclosures for source control may be fabricated on the site, or assembled from modular acoustic panel systems available from several manufacturers. Whatever the system or construction, it should be designed and built so as to enclose totally the noise source without air gaps; as noted, any gap in an acoustical construction that leaks air will also leak sound. It should be remembered that, when equipment is to be enclosed, it may be necessary to provide cooling air, combustion air, or both. Care must be taken to prevent noise from leaking out of the enclosure through air vents provided for such purposes.

Sound Flanking Paths

When designing or selecting structures to reduce the transmission of airborne sound, careful consideration must be given to flanking paths. Flanking paths are paths or routes that sound can take in traveling from one space to another other than by way of the main assembly separating the two spaces. For instance, a door in a wall assembly could be a flanking path.

As noted, any gap in an acoustical structure that leaks air will also leak sound. Sound leaks are flanking paths that can render useless an otherwise effective sound barrier. Typical flanking paths include joints between walls and ceilings, floors, or other walls; poorly fitted, unsealed, or undercut doors and windows; and mechanical or electrical service fittings and openings. The following suggestions will help reduce flanking sound paths.

Doors: Hollow core doors are poor sound blockers. When privacy is a key consideration, doors should be solid wood or have insulated cores, and should be gasketed to prevent sound from passing between the door and the jamb or sill.

Windows: Double pane and/or storm windows reduce sound transmission. Weather stripping helps. Windows facing exterior noise sources should be small and as few as possible. Double-hung windows should be able to be tightly closed.

Wiring and piping: Holes through which wiring or conduit passes should be sealed or caulked. Cutouts for electrical outlet boxes should be made precisely so boxes will fit snugly. Do not install electrical outlet boxes opposite each other on each side of a wall; these should be staggered. In bathrooms on opposite sides of a wall, medicine cabinets should be staggered. Holes cut out for piping should be sealed with caulking. Just stuffing the holes with insulation is not sufficient. Sound can easily pass through porous insulation. One can stuff the holes with insulation and then caulk over the insulation.

CONSTRUCTION DETAIL	EFFECTIVE NOISE REDUCTION VALUES, DB OCTAVE BAND CENTER FREQUENCIES, HZ					
	125	250	500	1000	2000	4000
1/2" plywood, unlined	13	14	15	21	21	25
1/2" plywood, lined with 2" fiberglass	15	16	19	22	25	27

Table 6: Effective noise reduction values in dB for plywood enclosure with fiberglass insulation lining

Structureborne Sound Transmission

Controlling sound transmission through floors is an important part of sound control in multi-story structures. In addition to the STC rating, which is related to airborne sound transmission, floor/ceiling assemblies are assigned an impact insulation class (IIC) rating based on how well they perform in reducing structureborne sound from impact such as footsteps or dropped objects. The IIC rating is determined by ASTM Standard E989, Standard Classification for Determination of Impact Insulation Class (IIC). Test data obtained in accordance with ASTM E492, Standard Test Method for Laboratory Measurement of Impact Sound Transmission Through Floor/Ceiling Assemblies Using the Tapping Machine, is used to determine the IIC rating of a floor.

Cushioning floor impact with a carpet and pad is one of the most effective methods of improving the IIC of a floor/ceiling assembly, but this does not significantly improve the STC rating. To increase both the STC and IIC ratings of a floor/ceiling construction, fiberglass insulation should be installed in the joist cavity, with a resilient ceiling system below the joists. The IIC rating of a floor/ceiling assembly should be equal to or better than its STC rating to achieve equal performance in controlling both airborne and structureborne sound. Figure 14 shows a typical floor/ceiling assembly.

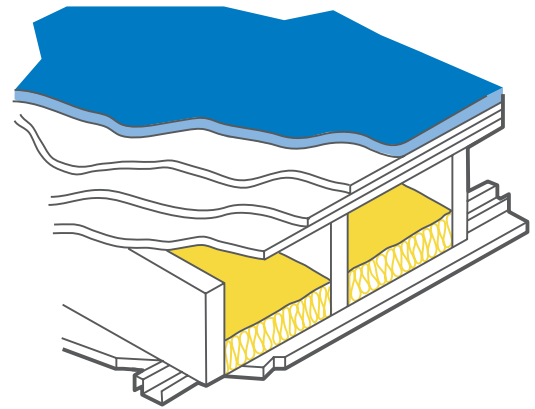
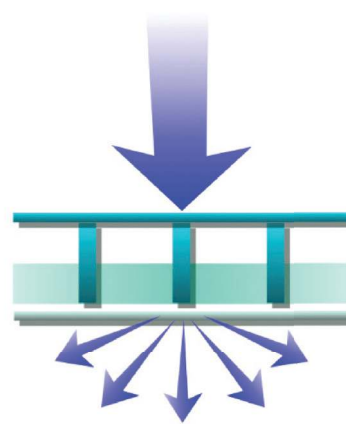

Figure 14: Floor/ceiling assembly with carpet and pad, particle board underlayment, plywood subfloor, resilient channels and gypsum board ceiling, with fiberglass insulation in joist cavities. STC = 53; IIC = 73.



Impact Insulation Class (IIC) measures floor-to-ceiling impact sound transmission. The higher the IIC rating, the better.

Controlling Sound Through Building Assemblies

Impact Sound Transmission Data Comparison of Wood Joist Floors

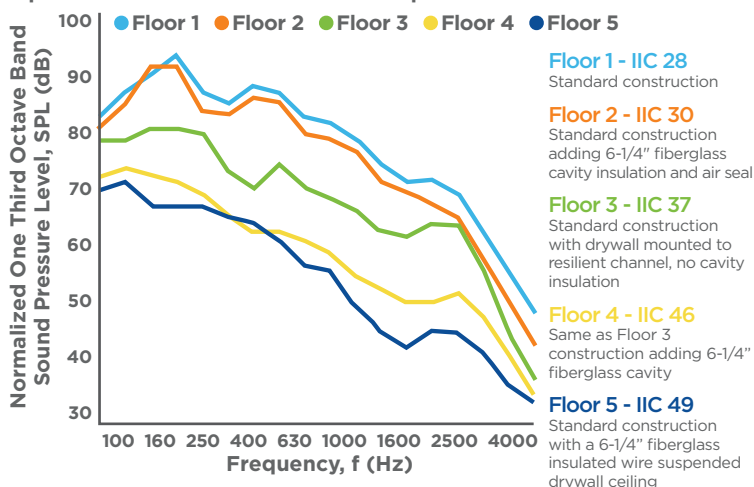

Wood Joist Floor - Ceiling Systems

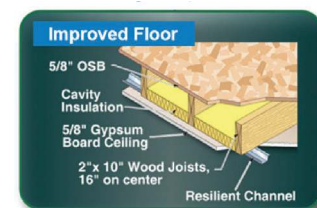
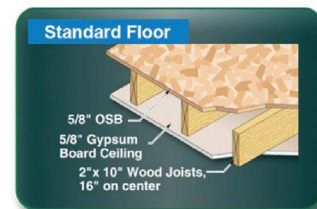

“There is no such thing as good acoustics and bad acoustics: only appropriate acoustics and inappropriate acoustics.”

Robert Coffeen, Acoustical Consultant

Sound Absorption

Definitions

We have defined sound as a form of energy. Sound absorption is the ability of a material to transform acoustical energy into some other form of energy, usually heat. All materials absorb some acoustical energy. Some materials, such as gypsum board, absorb it poorly, reflecting most of the energy that strikes their surfaces, while other materials, such as fiberglass insulation, absorb most of it.

Measuring sound absorption: The decimal fraction of the sound energy absorbed and not reflected by a material is termed its sound absorption coefficient. As materials absorb different amounts of sound energy at different frequencies, sound absorption coefficients are measured at one-third octave band center frequencies from 125 to 4000 Hz.



Noise Reduction Coefficient (NRC) measures sound absorption. NRC is most often used to measure in-room acoustics. The higher the NRC, the better.

Building materials are generally rated by their noise reduction coefficient (NRC). This single number rating is the average of the sound absorption coefficients of a material at 250, 500, 1000, and 2000 Hz, rounded

to the nearest .05. Sound absorption coefficients and single number rating values are determined using ASTM Standard C423, Standard Test Method for Sound Absorption and Sound Absorption Coefficients by the Reverberation Room Method. A material is usually considered to be a sound absorber if it has an NRC value greater than 0.35.

MATERIALS	125 Hz	250 Hz	500 Hz	1000 Hz	2000 Hz	4000 Hz
Brick, unglazed	.03	.03	.03	.04	.05	.07
Brick, unglazed, painted	.01	.01	.02	.02	.02	.03
Carpet 5/16", combined pile & foam	.05	.15	.13	.40	.50	.60
Concrete Block, painted	.10	.05	.06	.07	.09	.08
Fabric, Medium Velour, 14 oz. sq. yd., draped to half area	.07	.31	.49	.75	.70	.60
Wood Floors	.15	.11	.10	.07	.06	.07
Gypsum Board 1/2" nailed to 2X4's 16" o.c., painted	.10	.08	.05	.03	.03	.03
Marble or Glazed Tile	.01	.01	.01	.01	.02	.02

The sound absorption performance of a material is commonly published as a table of sound absorption coefficients at octave band center frequencies from 125 to 4000 Hz. For example, Table 7 gives sound absorption data for CertainTeed CertaPro™ Commercial Board, Type CB 300.

A new single number rating for sound absorption that will be replacing the NRC over the next several years is the sound absorption average (SAA). This is the average of the sound absorption coefficients of a material from 200 through 2500 Hz inclusive. As is the case with the NRC rating, a material is usually considered to be a sound absorber if it has an SAA value greater than 0.35.

Note that sound absorption tends to increase with material thickness (but does not always do so). Also note that some values exceed 1.00. It is of course impossible for any material to absorb more acoustical energy than that which strikes its surface. However, sound absorption measurements of highly absorptive materials often yield sound absorption coefficients greater than 1.00 due to diffraction effects. These values are reported as required by the test standard. When using sound absorption coefficients in calculations, values above 1.00 should be reduced to values less than 1.00. Differences in noise reduction coefficients as small as 0.05 cannot be detected by the human ear.

TYPE	THICKNESS		SOUND ABSORPTION COEFFICIENTS AT OCTAVE BAND CENTER FREQUENCIES, HZ						NRC
	INCHES	MM	125	250	500	1000	2000	4000	
CB 300 (Unfaced)	1	25 mm	0.08	0.25	0.72	0.88	0.93	0.94	0.70
	1-1/2	38 mm	0.10	0.51	0.89	0.95	0.92	0.93	0.80
	2	51 mm	0.21	0.73	1.08	1.04	1.04	0.96	0.95
	2-1/2	38 mm	0.31	0.81	1.08	1.02	1.04	1.03	1.00
	3	76 mm	0.41	0.96	1.13	1.03	1.03	1.02	1.05
	3-1/2	89 mm	0.72	1.14	1.11	1.00	1.02	1.00	1.05
	4	102 mm	0.75	1.18	1.09	1.00	1.00	1.02	1.05

Table 7: Sound absorption data for CertaPro™ Commercial Board, Type CB 300, unfaced

The sound absorption coefficients of a material are used to calculate the sabins of absorption when that material is used. The sabin is the unit of measure of sound absorption in the English system of units. It is equal to the sound absorption coefficient of a material times the area of the material used. For example, if a material has a sound absorption coefficient of 0.57 at 500 Hz and 250 square feet of this material is used in a room, then the sabins of absorption for this material at 500 Hz is $0.57 \times 250 = 142.5$ sabins. The sabins of absorption are used to calculate noise reduction in a room and reverberation time, which are discussed in later paragraphs.

To be an effective sound absorber, a material must have interconnecting air pockets or cells. Fiberglass insulation is a very good sound absorber because it has many interconnecting air pockets. Other effective sound absorbers, called resonators, typically employ small perforations or slots that allow sound to enter but not to escape easily. Wood slat panels and slotted concrete masonry units operate on this principle.

Another type, the Helmholtz Resonator, is a chamber with a small orifice, like a bottle; most of the sound entering the chamber is refracted within it and does not escape from it. Most resonators are effective only in a very narrow frequency range. Membranes or diaphragms stretched tightly over rigid perforated materials are also effective sound absorbers.

Sound Absorption and Noise Control

Sound absorption is used to control or reduce sound within a room, unlike sound transmission loss — which is used to describe the transmission of sound from one room to another. In addition to reducing the sound level in a room, the addition of sound absorption in a room can also reduce the room’s reverberation time. This is the time in seconds that it takes for a sound to decay or decrease 60 dB in level. For good speech intelligibility, the reverberation time in a room should be less than 1.0 seconds.

As was discussed in the section Sound transmission loss and noise control, when a noise source is enclosed to reduce the transmission of noise, the inside surface of the enclosure should be covered with a sound absorbing material. This is because a noise enclosure with high sound insertion loss properties will increase the noise level inside the enclosure because the sound is trapped inside the enclosure.

For example: If a noise source sound level is 90 dB and it is enclosed in a plywood housing having an insertion loss of 20 dB, the sound level within the enclosure should increase to 100 dB (Figure 15). Thus, the sound level outside the enclosure will be 80 dB instead of the expected 70 dB. However, by adding sound absorption to the inside of the enclosure, the sound level in the enclosure will not increase to 100 dB and the level outside the enclosure will be 70 dB (Figure 16).

“Freedom from the harassing effects of noise is one of the finest qualities a building can possess.”

Vern A Knudsen and Cyril M Harris, Acoustical Consultants

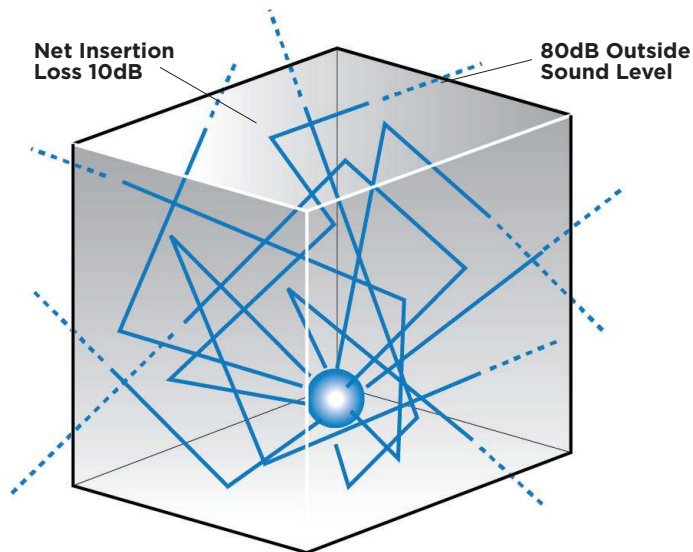

Figure 15: Noise enclosure without interior sound absorption. Exterior sound level is 80 dB.

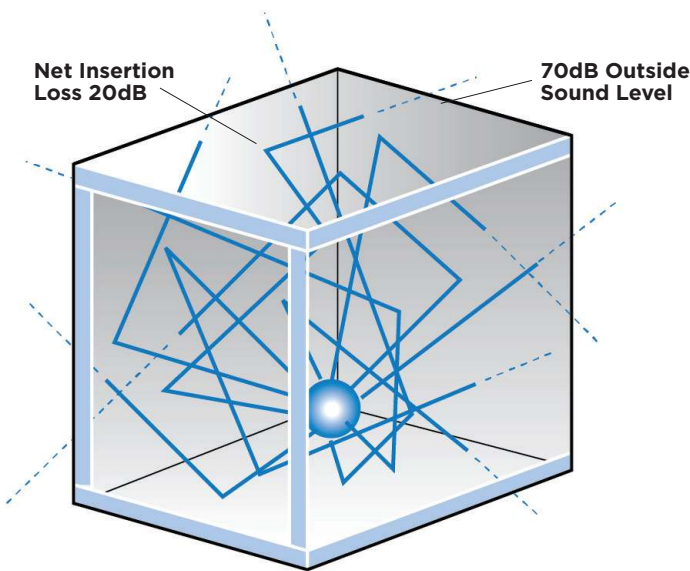

Figure 16: Noise enclosure without interior sound absorption. Exterior sound level is 70 dB.

Sound Level Reduction Calculation

This same principle can be used simply to reduce the sound level in a room. There is a simple relation between the reduction in sound level in a room and the amount of sound absorption added to the room. This relationship can be expressed in the following equation:

Reduction in sound level = $10 \log AA/AB$ dB
 Where: AA = sound absorption in sabins in the room after treatment, AB = sound absorption in sabins in the room before treatment.

For example, assume there is a room containing a noisy machine, and we want to decrease the noise level in the room. We can calculate how much the noise level will be reduced at a particular frequency by using the above equation. If we install an acoustical ceiling in the room, which now has only a gypsum board ceiling, we can calculate the noise reduction in the room. Assume the ceiling is 600 sq. ft. and has an absorption coefficient of 0.26 at 250 Hz. We will assume that the sabins of absorption from all of the other surfaces in the room at 250 Hz totaled 60 sabins before the ceiling was installed (Figure 17). When the ceiling is installed a total of 156 (0.27×600) sabins are added to the room. Now, the total amount of sabins at 250 Hz in the room is $60+156 = 216$ sabins. Thus, the noise level in the room is reduced by 5.5 dB ($10 \log 216/60$) by adding a sound absorbing ceiling (Figure 18).

Reverberation Time Calculation

The equation for calculating reverberation time is:
Reverberation time (T60) = $0.049V/A$ seconds

Where: V = volume of the room, cu. ft
A = sabins of absorption in the room

Using the room in the above example, we have a room volume of 5,400 cu. ft (9x20x30 ft). The amount of sabins in the room before the acoustical ceiling is installed is 60 sabins at 250 Hz. Installation of the acoustical ceiling adds 156 sabins, for a total

of 216. Reverberation time in the room before the acoustical ceiling is installed is 4.4 seconds. After the ceiling is installed, the reverberation time is 1.22 seconds. Now the lower reverberation time in the room with the acoustical ceiling provides good speech intelligibility.

A worksheet for calculating the room noise reduction and reverberation time is found in Section X of this manual.

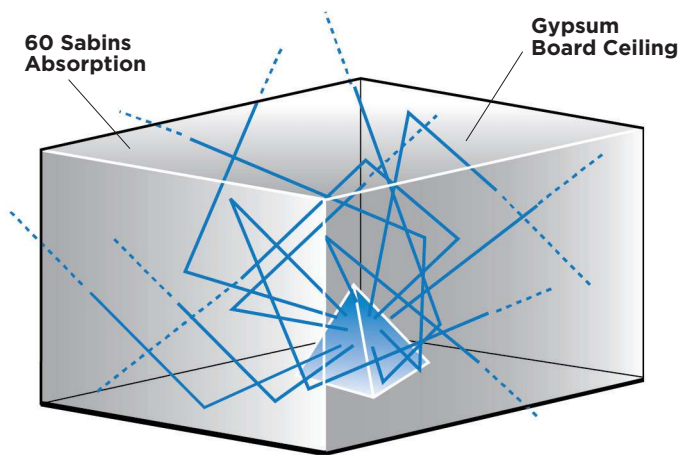

Figure 17: Room attenuation with gypsum board ceiling = 60 sabins at 250 Hz.

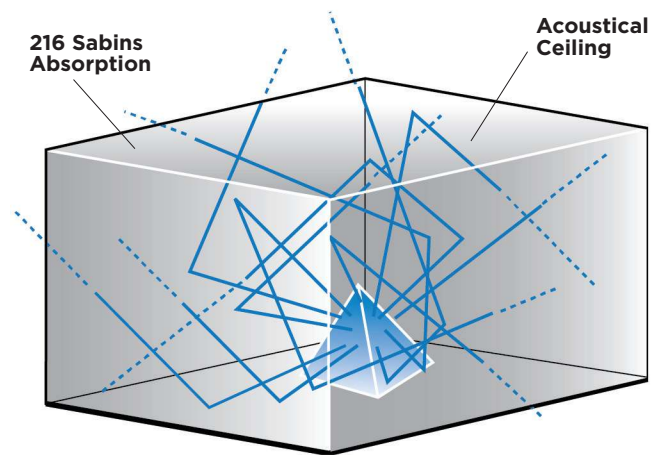

Figure 18: Acoustical ceiling adds 156 sabins, reduces noise level 5.5 dB.

Principles Of SPR Noise Control

We have shown that sound travels from the source, along a path, to the listener, or receiver. Hence the term SPR — source, path, receiver noise control. Control of noise thus involves three considerations: Acoustical treatment at the source of noise; acoustical treatment of the path it travels — everything between the source and the receiver; and acoustical treatment at the receiver — where the listener is.

The solution to a specific noise control situation often involves considering the problem from one, two, or all three of these factors. However, it is almost always best to start at the source. That's where the most effective solutions to noise control are likely to be easily achieved at the lowest cost.

Controlling Noise at the Source

Before designing acoustical treatment to attenuate noise at the source, consider the following measures:

1. Moving the source to a more distant location or to another area, where its noise will not reach an objectionable level at the listener's place.
2. Adjusting or modifying the source for quieter operation. If for example the source of noise is a mechanism such as a fan or motor, it may be operated at a lower speed.
3. Repairing or servicing the noise source. It may be as simple a matter as lubricating gears, tensioning drive belts, or tightening loose and vibrating screws or bolts.
4. Mounting the noise source on a resilient base (such as springs or soft pads) to isolate vibration and thus reduce the structureborne sound arriving at the listener's location.
5. Replacing the noise source with a quieter one. Modern appliances, for example, generally operate much more quietly than older models.

If these measures are not practical or, if attempted, fail to yield satisfactory results, the noise source should be enclosed within a housing having high sound transmission loss properties. Depending on the size of the noise source, such a housing might be constructed of plywood, gypsum board, sheet metal, or fiberglass-reinforced plastic.

We have shown that, if an enclosure with a high sound transmission loss value is lined with a material having a high sound absorption value, the overall sound transmission loss value will be increased and the overall noise reduction improved.

Obviously, if the noise source is outdoors — in the form of traffic noise, aircraft, power lawn mower, or any other source over which we have no control — we cannot move, adjust, repair, service, or replace it. All we can do in that case is try to reduce the noise along its path or at the receiver by building or retrofitting high sound transmission loss into the exterior walls and roofs of our homes, offices, and public buildings to attenuate these outside noises. It should be emphasized that it is far less costly to design noise control into a structure at the beginning than to retrofit after the building is built.

Controlling Noise Along its Path

Reflected sound may be reduced by placing sound absorbing materials on surfaces from which sound will be reflected (Figure 19).

Structureborne sound also travels along a path from source to receiver (listener). Sound waves can set walls and other structures into vibration; this motion travels through the structure and is re-radiated in the form of noise. The only way to reduce structureborne noise along its path is to put vibration breaks in the structure. This treatment can be very expensive to install after a structure is built. It is more effective to prevent vibration from entering a structure by isolating the source of vibration from the structure.

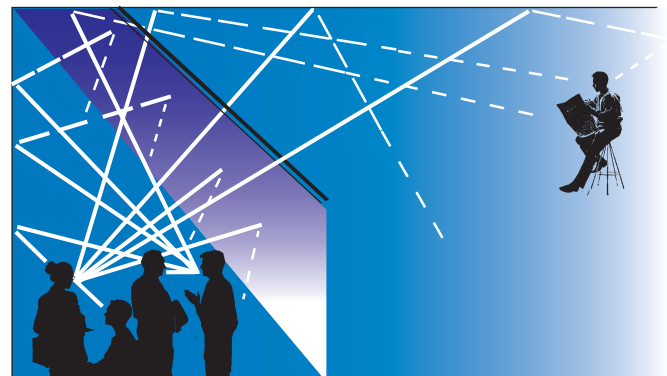

Figure 19: Sound absorbing materials on walls, ceiling, and floor.

Controlling Noise at the Receiver

As noted, the first and most practical location for successful noise control is at the source. Other practical solutions to noise control are often those involving treatment of the path, which usually involves multiple components — direct, reflected, and flanking. If source control is not practical, another approach would be to treat the problem at the receiver.

“Temporary” Sound Control

Direct ear protection (earplugs or earmuffs) is often used to protect workers’ hearing when source and path noise control are not practical or possible. However, such measures are considered by the U. S. Occupational Safety and Health Administration to be “temporary”; in most instances, OSHA mandates “permanent” noise reduction measures. There is only one way to provide “permanent” receiver noise control, and that is to enclose the listener in an acoustically effective enclosure or room.

The general principles of noise control at the source apply to noise control at the receiver. However, there are additional concerns involved including such features as doors, windows, ventilation, and lighting. All of these features will be required in an acoustically effective workplace, and all present their own sets of noise control problems.

Three Steps to Noise Control Solutions

1. Locate the source of noise

The first step in noise control is to investigate the real noise source. It has been mentioned that noise control problems may involve merely moving the source farther from the receiver, adjusting or repairing the source if it is a piece of noisy equipment, or replacing it. If none of these work, an acoustically efficient enclosure will have to be designed. Once the true source has been identified, the next step is to measure the noise.

2. Measure the noise

A sound level meter is used to measure the noise level at several locations — at its source, along its path, and at the receiver or listener’s location — using the A-weighted scale and also measuring the sound level in octave or third-octave bands. Sound level meter readings will not only provide sound pressure (loudness) levels at various locations, but will also show which frequencies are most offensive to the listener. This data will be helpful in selecting acoustical materials with sound absorption and/or sound reduction properties best suited to the particular application.

3. Design the solution

Once the noise source has been located, diagnosed, and measured, the solution can be designed. The first approach to solving the problem should generally focus on source control, either by modifying the noise-producing element itself or by covering it with an acoustical enclosure. If source attenuation is not practical, possible, or sufficient to lower the sound pressure level at the receiver position, then controlling or reducing the noise at the receiver should be considered. Usually, noise control along the path should be considered only if it is not possible to achieve the required noise reduction by source and receiver treatment.

Solving the noise problem may involve acoustic treatment at more than one location. For example, acoustical enclosure of the noise source plus sound absorbing materials along the noise path may be the most effective and economical way to reduce to an acceptable level the sound pressure at the receiver location.

Designing a solution to the noise problem may involve consideration of acoustical treatments that provide both sound absorption and sound transmission loss properties. For example, a plywood housing enclosing the noise source may provide adequate sound transmission loss performance, but its overall acoustical effectiveness will be improved by lining it with a sound absorbing material such as fiberglass insulation.

In any case, the services of a professional acoustical consultant will be well worth their fee in terms of time and money saved, false starts avoided, noise problems solved, and productivity and comfort restored.

“The dollar cost of noise...is vague...although certainly real enough. But the loss in real estate values is plain for all to see.”

Vern A Knudsen and Cyril M Harris, Acoustical Consultants

HVAC Noise Control

If not acoustically treated, noise from heating, ventilating, and air-conditioning equipment can travel from room to room in the home or in the office. Noise produced by fans and motors of central air equipment can be transmitted throughout the duct system. High air velocities in the duct system can cause noise-producing turbulence. Also, turning vanes, dampers, and other elements inside the ducts, grilles, and diffusers can whistle or rattle. HVAC ductwork can also act as a “speaking tube,” carrying conversations from one room or office into other spaces.

Noise from central equipment: When operating heating and air-conditioning equipment, a good guideline is “lower and slower”: lower volumes of air moved through the system with fans and blowers operating at a slower speed. Central air equipment should also be acoustically isolated from spaces where airborne noise would be objectionable. Equipment should be mounted on vibration isolators to avoid transmission of structureborne noise. Sound traps or baffles will help to attenuate equipment noise in adjacent ductwork.

Noise in air duct systems: Heating, ventilating, and air-conditioning ductwork can be a source of noise as well as a transmitter of it. Sheet metal ductwork without insulation can produce popping and banging noises due to expansion and contraction caused by changes in air temperature. Components within the duct system, abrupt changes in direction, and restrictions in the system can produce turbulence and air rush noise.

Most of these noise problems can be solved with fiberglass duct insulation in either of two forms:

1. Fiberglass duct liner, designed for installation inside sheet metal ductwork to attenuate air rush and central equipment noise as well as to control heat loss or gain through duct walls.
2. Fiberglass duct board, combining acoustical/thermal insulation with a reinforced foil-kraft air barrier/vapor retarder, from which complete air duct systems may be fabricated.

Fiberglass ducts wraps, used as thermal insulation on exteriors of sheet metal ducts, provide little acoustical benefit except by muffling the popping and banging noises when ducts undergo temperature changes.

Table 8, comparing sound attenuation in dB per lineal foot of uninsulated sheet metal, sheet metal lined with fiberglass duct liner, and fiberglass duct board, shows significant perceived noise reduction obtainable with fiberglass duct liner or duct board. Note: Individual products are often compared by their NRC values; however, differences of up to 0.1 in the NRC values published by their manufacturers have an insignificant effect on the sound attenuation in the installed duct.

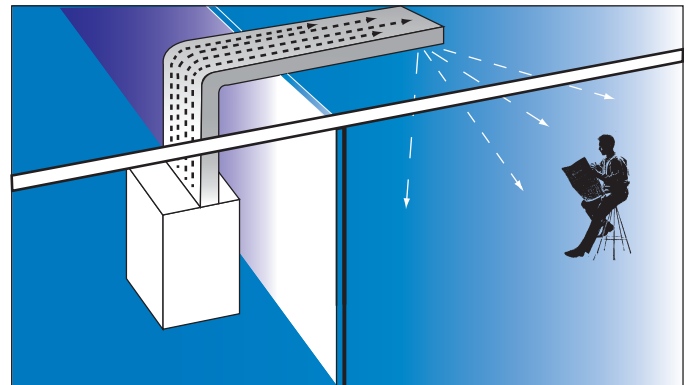

Figure 20: Significant noise reduction can be obtained by lining sheet metal ducts with fiberglass duct liner, or by fabricating duct systems of fiberglass duct board.

OCTAVE BAND CENTER FREQUENCIES, HZ

	125	250	500	1000	2000	4000
Uninsulated sheet metal ducts	0.1	0.1	0.1	0.1	0.1	0.1
Sheet metal ducts with 1" duct liner	0.3	0.7	1.9	5.3	4.8	2.3
Fiberglass duct board, 1" thick	0.4	1.4	3.3	3.9	5.0	3.7

Table 8: Duct noise attenuation loss, dB per lineal foot

INSULPURE DUCT WRAP ACOUSTICAL PERFORMANCE

PRODUCT		NOMINAL THICKNESS		TRANSMISSION LOSS (DB) AT OCTAVE BAND CENTER FREQUENCIES (HZ)					
Type	Facing	in.	mm.	125	250	500	1000	2000	4000
75	FSK	1	38	13	17	26	34	45	55
	FSK	1-1/2	51	13	17	26	36	47	58
	FSK	2	64	14	18	28	38	49	62
	FSK	3	76	14	18	29	40	51	64
100	FSK	1-1/2	38	14	18	27	37	47	37
	FSK	2	51	14	18	28	39	49	61

Typical sound transmission loss values for InsulPure Duct Wrap on 20-gauge sheet metal when tested according to ASTM E90.



Residential Sound Control Practices

In addition to the specific sound rated construction assemblies detailed in this guide, certain construction practices are recommended to reduce sound transmission.

To obtain maximum benefit with sound rated constructions, the perimeter of the construction must be sealed with caulking wherever it is not completely sealed by normal construction methods (e.g., tape and joint compound). In general, penetrations such as service lines (e.g., plumbing and gas lines), electrical outlets, and medicine cabinets should be minimized. If penetrations are necessary, openings should be caulked airtight; they can also be filled with fiberglass insulation. If medicine cabinets are installed, they should be surface mounted, and if electrical boxes are to be included on each side of the partition, they should not be installed “back-to-back” within the same stud space.

Plumbing noise can be reduced by using larger pipes or cast-iron pipes, installing air chambers to eliminate water hammer, and by isolating pipes from structural framing with resilient rods. Doors of solid wood or mineral core provide better sound control than hollow core doors. Door frames and sills should

be gasketed to seal tightly when doors are closed. Windows should have weatherstripping and double panes of insulating glass. The use of heavy curtains or draperies can help reduce sound transmission.

As with partition and wall construction, penetrations in sound rated floor/ceiling assemblies should be caulked airtight. Ceiling fixtures should be surface mounted, not recessed, and carpet and pad or resilient tile will greatly reduce impact sound transmission through these assemblies.

The right insulation material

CertainTeed offers a complete line of insulation products made of one of the most dependable, durable, and effective materials — fiberglass. In addition to its thermal properties, fiberglass is also an excellent acoustical material.

CertainTeed fiberglass batts and loosefill insulation can help to effectively control sound in walls and ceilings. CertainTeed Insulation is made with a high percentage of renewable and recycled content contains no added formaldehyde. The illustrations that start on page 23 are representative of the more common applications of fiberglass insulation for acoustical purposes.

In addition to the previously mentioned products, CertainTeed offers other products that can be used for sound control. CertainTeed ToughGard® R Fiberglass Duct Liner, ToughGard® Duct Board, UltraDuct Duct Board, Fiberglass Duct Wrap and CertainTeed Commercial Board are also widely used for sound control.

“In many instances it is no more expensive to design a machine to operate quietly than it is to design it to be noisy.”

George Diehl, retired Acoustical Engineer

Five noise control mistakes to avoid

1. Thinking you don't have a noise problem. In a factory you have a noise problem if a person is exposed to a noise level greater than an A-weighted level of 85 dB. Ear protectors should only be considered a temporary solution to such a noise problem. Even lower levels could be a problem, such as a 55 dB level in a classroom. In general, if communications is difficult in a noisy area, you have a noise problem.

2. Not considering noise control before a project is started. Although a source of noise can be treated after installation, it's generally twice as expensive and half as effective compared with designing proper noise control into the system before the noise source is installed.

3. Not conducting a detailed study of noisy equipment. Most noisy equipment has several noise sources, all of which must be considered. When analyzing noise sources, the spectrum of the noise from the equipment needs to be studied. At minimum, octave band noise levels from the equipment should be obtained. You cannot solve a noise problem by knowing only the overall noise level generated by the equipment.

4. Not using a systems approach to noise control. A common waste of noise control dollars is the failure to consider all possible solutions and noise paths. To treat one noise source and not consider all possible noise sources could lead to unacceptable noise levels when a project is completed. The same is true if only one path of noise transmission is considered. All airborne and structureborne noise paths must be studied.

5. Not sealing air leaks. Sound always takes the easiest path around or through a barrier. Construction gaps or air leaks are by far the easiest way for sound to pass from one space to another.

**CertaSEAL** INT TM

**Air seal penetrations and joints
in residential building envelope
and stud/drywall interfaces.**

Building Insulation Assemblies

Table I.

One-third octave band sound absorption coefficients of typical building materials

PRODUCT	OCTAVE BAND CENTER FREQUENCIES, HZ						NRC
	125	250	500	1000	2000	4000	
Brick, unglazed	0.03	0.03	0.03	0.04	0.05	0.07	0.05
Brick, unglazed, painted	0.01	0.01	0.02	0.02	0.02	0.03	0.00
Concrete block, painted	0.10	0.05	0.06	0.07	0.09	0.08	0.05
Carpet, 1/8" pile height	0.05	0.05	0.10	0.20	0.30	0.40	0.15
Carpet, 1/4" pile height	0.05	0.10	0.15	0.30	0.50	0.55	0.25
Carpet, 3/16" combined pile and foam	0.05	0.10	0.10	0.30	0.40	0.50	0.25
Carpet, 5/16" combined pile and foam	0.05	0.15	0.30	0.40	0.50	0.60	0.35
Fabric, light velour, 10 oz./sq. yd. hung straight in contact with wall	0.03	0.04	0.11	0.17	0.24	0.35	0.15
Fabric, medium velour, 14 oz./sq. yd. draped to half area	0.07	0.31	0.49	0.75	0.70	0.60	0.55
Fabric, heavy velour, 18 oz./sq. yd. draped to half area	0.14	0.35	0.55	0.72	0.70	0.65	0.60
Floors, concrete or terrazzo	0.01	0.01	0.01	0.02	0.02	0.02	0.00
Floors, linoleum, asphalt, rubber or cork tile on concrete	0.02	0.03	0.03	0.03	0.03	0.02	0.05
Floors, wood	0.15	0.11	0.10	0.07	0.06	0.07	0.10
Floors, wood parquet in asphalt or concrete	0.04	0.04	0.07	0.06	0.06	0.07	0.05
Glass, 1/4", sealed, large panes	0.05	0.03	0.02	0.02	0.03	0.02	0.05
Glass, 24 oz. operable windows, closed	0.10	0.05	0.04	0.03	0.03	0.03	0.05
Gypsum board, 1/2", nailed to 2x4s on 16" centers, painted	0.10	0.08	0.05	0.03	0.03	0.03	0.05
Marble or glazed tile	0.01	0.01	0.01	0.01	0.02	0.02	0.00
Plaster, gypsum or lime, rough finish or lath	0.02	0.03	0.04	0.05	0.04	0.03	0.05
Plaster, gypsum or lime, smooth finish	0.02	0.02	0.03	0.04	0.04	0.03	0.05
Plywood paneling, 1/4" thick, wood frame	0.58	0.22	0.07	0.04	0.03	0.07	0.10
Water surface, as in swimming pool	0.01	0.01	0.01	0.01	0.02	0.03	0.00
Wood roof decking, tongue-in-groove cedar	0.24	0.19	0.14	0.08	0.13	0.10	0.15

From "Acoustical Ceilings — Use and Practice," Ceilings and Interior Systems Contractors Association (1984), p.18.ot

Table II.

**One-third octave band sound absorption coefficients of CertainTeed fiberglass insulation.
 CertainTeed CertaPro™ Commercial Board, Unfaced Tested in accordance with ASTM C423,
 ASTM E795 Type A mounting**

PRODUCT	THICKNESS		OCTAVE BAND CENTER FREQUENCIES, HZ						NRC
	IN.	MM	125	250	500	1000	2000	4000	
CB 150	1-1/2	38	0.19	0.51	0.82	0.86	0.95	0.97	0.80
	2	51	0.23	0.61	0.94	0.97	0.98	0.96	0.90
	2-1/2	64	0.41	0.78	0.96	0.94	0.93	0.97	0.90
	3	76	0.41	0.94	1.07	1.01	1.00	0.97	1.00
	3-1/2	89	0.60	1.08	1.09	1.02	1.04	1.06	1.05
	4	102	0.64	1.05	1.07	0.97	0.96	1.01	1.00
CB 225	1	25	0.06	0.30	0.68	0.85	0.91	0.94	0.70
	1-1/2	38	0.12	0.48	0.83	0.90	0.90	0.89	0.80
	2	51	0.22	0.63	1.04	1.00	1.00	0.97	0.90
	2-1/2	64	0.31*	0.81*	1.08*	1.02*	1.04*	1.03*	1.00*
	3	76	0.34	0.95	1.08	0.99	0.98	0.99	1.00
	3-1/2	89	0.54	1.11	1.12	1.01	1.02	1.00	1.05
CB 300	1	25	0.08	0.25	0.72	0.88	0.93	0.94	0.70
	1-1/2	38	0.10	0.51	0.89	0.95	0.92	0.93	0.80
	2	51	0.21	0.73	1.08	1.04	1.04	0.96	0.95
	2-1/2	64	0.31	0.81	1.08	1.02	1.04	1.03	1.00
	3	76	0.41	0.96	1.13	1.03	1.03	1.02	1.05
	3-1/2	89	0.72	1.14	1.11	1.00	1.02	1.00	1.05
CB 600	1	25	0.05	0.27	0.78	0.97	0.97	0.91	0.75
	1-1/2	38	0.17	0.50	0.98	1.03	0.99	0.98	0.90
	2	51	0.31	0.89	1.07	0.99	1.02	0.98	1.00

*Estimated sound absorption coefficients and NRC

CertainTeed CertaPro™ AcoustaBoard™ Black
Tested in accordance with ASTM C423, ASTM E795 Type A mounting

PRODUCT	THICKNESS		OCTAVE BAND CENTER FREQUENCIES, HZ						NRC
	IN.	MM	125	250	500	1000	2000	4000	
TYPE 225	1	25	0.06	0.25	0.58	0.85	0.91	0.94	0.65
	1-1/2	38	0.12	0.48	0.83	0.90	0.90	0.89	0.80
	2	51	0.20	0.72	1.08	1.04	1.01	0.98	0.95
TYPE 300	1	25	0.05	0.26	0.69	0.89	0.92	0.96	0.70
	1-1/2	38	0.10	0.51	0.89	0.95	0.92	0.93	0.80
	2	51	0.17	0.76	1.05	1.02	0.95	0.96	0.95

CertainTeed CertaPro™ AcoustaBlanket™ Black
Tested in accordance with ASTM C423 , ASTM E795 Type A mounting

PRODUCT	THICKNESS		OCTAVE BAND CENTER FREQUENCIES, HZ						NRC
	IN.	MM	125	250	500	1000	2000	4000	
TYPE 150	1	25	0.10	0.32	0.66	0.84	0.91	0.91	0.70
	1-1/2	38	0.11	0.52	0.95	0.96	0.99	0.96	0.85
	2	51	0.24	0.79	1.09	1.05	1.02	1.01	1.00
TYPE 200	1/2	13	0.03	0.12	0.35	0.61	0.75	0.84	0.45

CertainTeed Fiberglass Building Insulation

PRODUCT	THICKNESS		OCTAVE BAND CENTER FREQUENCIES, HZ						NRC
	IN.	MM	125	250	500	1000	2000	4000	
R-13 UNFACED BATTS	3-1/2	89	0.30	0.87	1.05	0.97	1.01	1.07	1.00
R-15 UNFACED BATTS	3-1/2	89	0.51	1.14	1.19	1.05	1.04	1.06	1.10
R-19 UNFACED BATTS	6-1/4	158.75	0.59	0.98	0.90	0.97	1.03	1.07	0.95
R-38 UNFACED BATTS	12	305	1.40	1.22	1.05	1.02	1.04	1.08	1.10
R-13 FSK FACED BATTS	3-1/2	89	0.35	1.02	1.06	0.82	0.66	0.39	0.90
R-19 FSK FACED BATTS	6-1/4	158.75	0.62	1.04	0.94	0.79	0.64	0.44	0.85

Table III.

One-third octave band sound transmission loss values, common building materials



PRODUCT	OCTAVE BAND CENTER FREQUENCIES, HZ						STC
	125	250	500	1000	2000	4000	
Plywood, 1/2", 1.33 lb/sq.ft.	17	20	23	23	23	24	21
Plywood, 3/4", 2.00 lb/sq.ft.	19	23	27	25	22	30	24
Sheet metal, 16 gauge, 2.38 lb/sq.ft.	18	22	28	31	35	41	31
Sheet metal, 20 gauge, 1.50 lb/sq.ft.	16	19	25	27	32	39	27
Sheet metal, 24 gauge, 1.02 lb/sq.ft.	13	16	23	24	29	36	25
Gypsum board, 1/2", 1.80 lb/sq.ft.	18	22	26	29	27	26	26
Gypsum board, 5/8", 2.20 lb/sq.ft.	19	22	25	28	22	31	26
Glass, single strength, 3/32", 1.08 lb/sq.ft.	25	18	25	26	28	29	26
Glass, double strength, 1/8", 1.40 lb/sq.ft.	16	19	25	29	30	20	24
Glass, plate, 1/4", 2.78 lb/sq.ft.	20	25	26	30	23	30	27
Acrylic sheet, 1/8", 0.75 lb/sq.ft.	14	17	22	24	27	34	24
Acrylic sheet, 1/4", 1.45 lb/sq.ft.	16	19	26	27	30	29	27
Acrylic sheet, 1/2", 2.75 lb/sq.ft.	20	24	27	30	29	35	29
Lead vinyl, 1.25 lb/sq.ft.	17	19	28	30	34	39	29

Table IV.

One-third octave band sound transmission loss values, wood stud wall assemblies

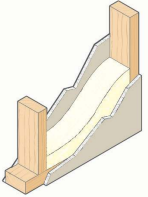
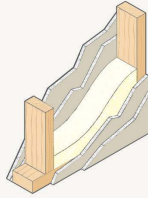
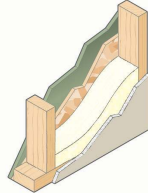
Data sources: National Research Council Canada; Riverbank Acoustical Laboratories

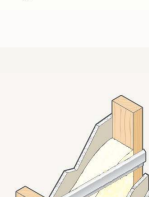
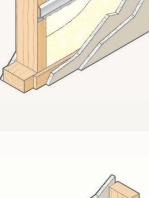
		OCTAVE BAND CENTER FREQUENCIES, HZ						STC
		125	250	500	1000	2000	4000	
SINGLE 2" X 4" STUDS, 16" CENTERS, ON 2" X 6" WOOD PLATE								
1 layer 1/2" CertainTeed gypsum board each side 3-1/2" CertainTeed fiberglass insulation		15	31	38	51	58	47	39
2 layers 1/2" CertainTeed gypsum board each side 3-1/2" CertainTeed fiberglass insulation		31	49	57	62	66	64	55
Exterior Surface: Vinyl Siding 1/2" Plywood Sheathing Interior Surface: 1/2" CertainTeed gypsum board 3-1/2" CertainTeed fiberglass insulation		16	30	32	47	57	54	38

		OCTAVE BAND CENTER FREQUENCIES, HZ						STC
		125	250	500	1000	2000	4000	
SINGLE 2" X 4" STUDS, 24" CENTERS, ON 2" X 4" WOOD PLATE								
1 layer 1/2" CertainTeed gypsum board each side Resilient channels on 24" centers 3-1/2" CertainTeed fiberglass insulation		22	43	56	65	63	53	46
1 layer 5/8" CertainTeed gypsum board each side Resilient channels on 24" centers 3-1/2" CertainTeed fiberglass insulation		26	47	57	63	50	57	50
2 layers 1/2" CertainTeed gypsum board one side 1 layer 1/2" CertainTeed gypsum board other side Resilient channels on 24" centers 3-1/2" CertainTeed fiberglass insulation		27	47	59	68	67	59	51
2 layers 5/8" CertainTeed gypsum board one side 1 layer 5/8" CertainTeed gypsum board other side Resilient channels on 24" centers 3-1/2" CertainTeed fiberglass insulation		29	46	56	64	56	64	53
2 layers 1/2" CertainTeed gypsum board both sides Resilient channels on 24" centers 3-1/2" CertainTeed fiberglass insulation		33	51	61	69	70	64	57
2 layers 5/8" CertainTeed gypsum board both sides Resilient channels on 24" centers 3-1/2" CertainTeed fiberglass insulation		35	52	61	67	60	68	59

**SINGLE 2" X 4" STUDS, 16" CENTERS,
ON 2" X 4" WOOD PLATE**

OCTAVE BAND CENTER FREQUENCIES, HZ

STC

		125	250	500	1000	2000	4000	
1 layer 1/2" CertainTeed gypsum board both sides 3-1/2" CertainTeed fiberglass insulation		21	41	50	59	61	57	45
1 layer 5/8" CertainTeed gypsum board both sides 3-1/2" CertainTeed fiberglass insulation		30	43	51	56	45	54	48
1 layer 5/8" CertainTeed gypsum board one side 2 layers 5/8" CertainTeed gypsum board other side 3-1/2" CertainTeed fiberglass insulation		30	46	52	56	52	65	52
2 layers 1/2" CertainTeed gypsum board both sides 3-1/2" CertainTeed fiberglass insulation		31	49	57	62	66	64	55
2 layers 5/8" CertainTeed gypsum board both sides 3-1/2" CertainTeed fiberglass insulation		34	50	56	59	55	69	56

**DOUBLE 2" X 4" STUDS, 16" CENTERS,
ON 2" X 4" WOOD PLATES, 1/2" SPACE BETWEEN**

OCTAVE BAND CENTER FREQUENCIES, HZ

STC

		125	250	500	1000	2000	4000	
1 layer 1/2" CertainTeed gypsum board both sides 3-1/2" CertainTeed fiberglass insulation		29	48	60	70	73	66	53

One-third octave band sound transmission loss values, wood joist floor/ceiling assemblies

Data sources: National Research Council Canada; Riverbank Acoustical Laboratories

		OCTAVE BAND CENTER FREQUENCIES, HZ						STC
		125	250	500	1000	2000	4000	
1 layer 1/2" CertainTeed gypsum board both sides 2 layers 3-1/2" CertainTeed fiberglass insulation		34	50	64	77	85	79	58
1 layer 5/8" CertainTeed gypsum board both sides 2 layers 3-1/2" CertainTeed fiberglass insulation		34	51	65	77	75	86	58
2 layers 1/2" CertainTeed gypsum board one side 1 layer 1/2" CertainTeed gypsum board other side 2 layers 3-1/2" CertainTeed fiberglass insulation		38	56	69	80	87	84	62
2 layers 5/8" CertainTeed gypsum board one side 1 layer 5/8" CertainTeed gypsum board other side 2 layers 3-1/2" CertainTeed fiberglass insulation		38	56	69	78	74	85	62
2 layers 1/2" CertainTeed gypsum board both sides 2 layers 3-1/2" CertainTeed fiberglass insulation		42	61	73	81	86	85	66
2 layers 5/8" CertainTeed gypsum board both sides 2 layers 3-1/2" CertainTeed fiberglass insulation		43	61	72	81	75	88	67

Table V.

One-third octave band sound transmission loss values, wood stud wall assemblies

Data sources: National Research Council Canada; Riverbank Acoustical Laboratories

		OCTAVE BAND CENTER FREQUENCIES, HZ						STC
		125	250	500	1000	2000	4000	
SINGLE 2½" STEEL STUDS, 24" CENTERS								
1 layer 1/2" CertainTeed gypsum board both sides 2-1/2" CertainTeed AcoustaTherm batts		21	39	54	62	59	48	45
1 layer 5/8" CertainTeed gypsum board both sides 2-1/2" CertainTeed AcoustaTherm batts		20	41	55	61	50	52	44
2 layers 1/2" CertainTeed gypsum board one side 1 layer 1/2" CertainTeed gypsum board other side 2-1/2" CertainTeed AcoustaTherm batts		27	44	58	65	63	54	51
2 layers 5/8" CertainTeed gypsum board one side 1 layer 5/8" CertainTeed gypsum board other side 2-1/2" CertainTeed AcoustaTherm batts		27	46	59	64	52	56	51
2 layers 1/2" CertainTeed gypsum board both sides 2-1/2" CertainTeed AcoustaTherm batts		33	45	59	65	66	58	55
2 layers 5/8" CertainTeed gypsum board both sides 2-1/2" CertainTeed AcoustaTherm batts		32	48	61	64	56	59	55
SINGLE 3 5/8" STEEL STUDS, 24" CENTERS								
1 layer 1/2" CertainTeed gypsum board both sides 3-1/2" CertainTeed AcoustaTherm batts		26	37	52	60	63	49	48
1 layer 5/8" CertainTeed gypsum board both sides 3-1/2" CertainTeed AcoustaTherm batts		26	44	58	65	50	55	50

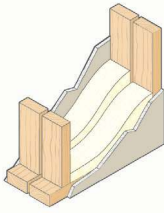
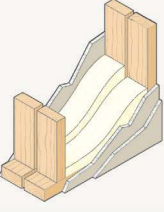
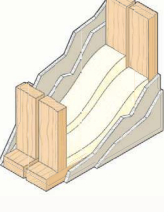
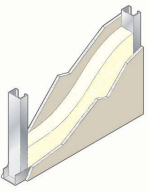
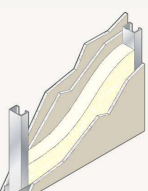
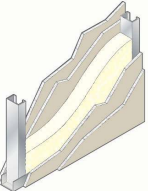
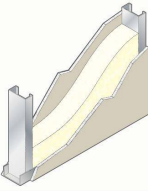
One-third octave band sound transmission loss values, wood joist floor/ceiling assemblies

Data sources: National Research Council Canada; Riverbank Acoustical Laboratories

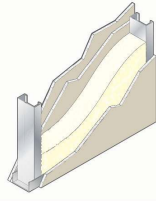
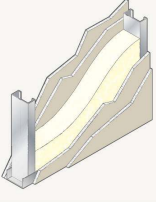
SINGLE 3-5/8" STEEL STUDS, 24" CENTERS		OCTAVE BAND CENTER FREQUENCIES, HZ						STC
		125	250	500	1000	2000	4000	
2 layers 1/2" CertainTeed gypsum board one side 1 layer 1/2" CertainTeed gypsum board other side 3-1/2" CertainTeed AcoustaTherm batts		31	42	56	63	65	53	52
		31	47	61	68	59	57	55
2 layers 1/2" CertainTeed gypsum board both sides 3-1/2" CertainTeed AcoustaTherm batts		31	48	61	68	65	58	55
		35	50	62	69	60	62	58

SINGLE 6" STEEL STUDS, 24" CENTERS		OCTAVE BAND CENTER FREQUENCIES, HZ						STC
		125	250	500	1000	2000	4000	
1 layer 5/8" CertainTeed gypsum board both sides 6-1/4" CertainTeed AcoustaTherm batts		30	46	60	65	52	53	51

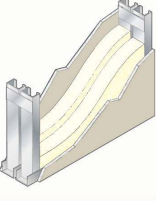
CHASE WALLS - DOUBLE STEEL STUD, 24" CENTERS		OCTAVE BAND CENTER FREQUENCIES, HZ						STC
		125	250	500	1000	2000	4000	
1 layer 1/2" CertainTeed gypsum board both sides 2 layers 2-1/2" CertainTeed AcoustaTherm batts		30	45	57	69	74	61	54
		31	48	58	69	60	64	55

One-third octave band sound transmission loss values, wood joist floor/ceiling assemblies

Data sources: National Research Council Canada; Riverbank Acoustical Laboratories

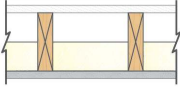
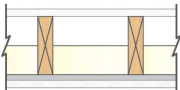
		OCTAVE BAND CENTER FREQUENCIES, HZ						STC
		125	250	500	1000	2000	4000	
2" X 10" WOOD JOIST @ 16"OC								
1 layer 5/8" OSB 6" CertainTeed batts 1 layer 5/8" CertainTeed gypsum board		18	26	30	41	39	48	34
	1 layer 5/8" OSB 6" CertainTeed batts 1/2" Resilient channel 1 layer 5/8" CertainTeed gypsum board		30	40	55	62	55	61

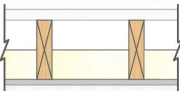
		OCTAVE BAND CENTER FREQUENCIES, HZ						STC
		125	250	500	1000	2000	4000	
2" X 14" WOOD JOIST @ 24"OC								
1 layer 3/4" OSB 6" CertainTeed batts 1/2" Resilient channel 1 layer 5/8" CertainTeed gypsum board		32	44	55	62	59	68	55

		OCTAVE BAND CENTER FREQUENCIES, HZ						STC
		125	250	500	1000	2000	4000	
2" X 24" WOOD JOIST @ 24"OC								
1 layer 3/4" OSB 6" CertainTeed batts 1/2" Resilient channel 1 layer 5/8" CertainTeed gypsum board		33	46	56	63	59	71	55

Appendix

Acoustical Guide Specification Part 1 — General

1.01 Summary

- A. Provide glass fiber acoustical insulation as indicated in building plans.

1.02 Materials Provided in Other Sections

These sections are typically cross-referenced. Delete sections not included in project manual.

- A. Section 09250 — Gypsum Board
- B. Section 09260 — Gypsum Board Systems
- C. Section 09100 — Metal Support Systems

1.03 References

- A. ASTM Standards
 1. ASTM E90, *Laboratory Measurement of Airborne Sound Transmission Loss of Building Partitions*
 2. ASTM E413, *Rating Sound Insulation*
 3. ASTM E84, *Test Method for Surface Burning Characteristics of Building Materials*
 4. ASTM E119, *Method for Fire Tests of Building Construction Materials*
 5. ASTM E136, *Test Method for Behavior of Materials in a Vertical Tube Furnace at 750°C*
 6. ASTM C518, *Test Method for Steady State Thermal Transmission Properties by Means of the Heat Flow Meter*
 7. ASTM C665, *Specification for Mineral Fiber Blanket Thermal Insulation for Light Frame Construction and Manufactured Housing*

1.04 Submittals

- A. Product Data: Submit manufacturer's product literature, samples, and installation instructions for specified insulation.

1.05 Delivery, Storage, and Handling

- A. Protect insulation from physical damage and from becoming wet, soiled, or covered with ice or snow. Comply with manufacturer's recommendations for handling, storage, and protection during installation.
- B. Label insulation packages to include material name, production date, and/or product code. Delete paragraph below if sections 01600 or 01620 are not included in project manual.

- C. Deliver and store materials under provisions of section (01600) (01620).

1.06 Limitations

- A. Do not use unfaced insulation in exposed applications where there is potential for skin contact and irritation.

Acoustical Guide Specification Part 2 — Products

2.01 Manufacturer

- A. CertainTeed, Malvern, PA, 19355

2.02 Material

(Specify name of CertainTeed fiberglass insulation product)

- A. Type: Unfaced fiberglass insulation complying with ASTM C665.
- B. Combustion characteristics: Passes ASTM E136 test.
- C. Surface burning characteristics:
 1. Maximum flame spread: 25.
 2. Maximum smoke developed: 50 when tested in accordance with ASTM E84.*
- D. Fire resistance rating: Passes ASTM E119 test.
- E. Sound transmission class of the assembly: STC = ____
- F. Size of insulation:
 1. Thickness, _____
 2. Width, _____
 3. Length, _____

2.03 Gypsum Board

- A. Refer to Section (09250) (09260) for detailed specifications. Select appropriate construction:
- B. Type: 1/2" thick, CertainTeed gypsum panels
- C. Type: 5/8" thick, CertainTeed gypsum panels

2.04 Metal Framing

- A. Refer to Section (09250) (09260) for detailed specifications. Select appropriate construction:
- B. Type: 2-1/2" steel stud
- C. Type: 3-5/8" steel stud

* This standard is used solely to measure and describe the properties of products in response to heat and flame under controlled conditions. These numerical ratings are not intended to reflect hazards presented by this or any other material under actual fire conditions. Values are reported to the nearest 5 rating.

Acoustical Guide Specification Part 3 — Execution

3.01 Inspection and Preparation

- A. Examine substrates and conditions under which insulation work is to be performed. A satisfactory substrate is one that complies with requirements of the section in which substrate and related work is specified.
- B. Obtain installer's written report listing conditions detrimental to performance of work in this section. Do not proceed with installation until unsatisfactory conditions have been corrected.
- C. Clean substrates of substances harmful to insulation.

3.02 Installation — General

- A. Comply with manufacturer's instructions for particular conditions of installation in each case.
- B. Batts may be friction-fit in place until the interior finish is applied. Install batts to fill entire stud cavity. If stud cavity is less than 96" in height, cut lengths to friction-fit against floor and ceiling tracks. Walls with penetrations require that insulation be carefully cut to fit around outlets, junction boxes, and other irregularities.
- C. Where insulation must extend higher than 8 feet, supplementary support can be provided to hold product in place until the interior finish is applied.

Glossary of Acoustical Terms

Acoustical material: Any material considered in terms of its acoustical properties. Commonly and especially, a material designed to absorb sound.

Airborne sound: Sound which arrives at the point of concern, such as one side of a wall, by propagation through air.

A-weighted sound level (dB): The most common single number rating system for measuring the loudness of a noise. It may be read directly on most sound level meters by selecting the designated scale. It is obtained by applying the A-weighted frequency response curve to the measured sound. The response curve is indicative of the way humans respond to different frequencies.

Attenuation: The reduction in magnitude of airborne sound pressure level between two points in the sound transmission path from source to receiver.

Background noise: Noise from all sources unrelated to a particular sound that is the object of interest. Background noise may include airborne, structureborne, and instrument noise.

Decibel (dB): The term used to identify ten times the common logarithm of the ratio of two like quantities proportional to power or energy. (See Sound transmission loss.) Thus, one decibel corresponds to a power ratio of (10 to the 0.1 power) to the n power. Note: Since the decibel expresses the ratio of two like quantities, it has no dimensions. It is, however, common practice to treat "decibel" as a unit, as for example in the sentence: "The average sound pressure level in the room is 45 decibels."

Diffuse sound field: The sound in a region where the intensity is the same in all directions and at every point.

Direct sound field: The sound that arrives directly from a source without reflection.

Flanking transmission: The transmission of sound between two rooms by any path other than directly through a common partition.

Frequency: The number of cycles per second measured in units of Hertz (Hz). One hertz is one complete oscillation per second. A frequency of 1000 Hz means 1000 cycles per second.

Impact insulation class (IIC): A single number rating derived from measured values of normalized impact sound pressure levels in accordance with Annex 1 of ASTM Method E492, *Laboratory Measurement of Impact Sound Transmission Through Floor-Ceiling Assemblies Using the Tapping Machine*. It provides an estimate of the impact sound insulation performance of a floor-ceiling assembly.

Noise: Unwanted sound.

Noise isolation class (NIC): A single number rating calculated from measured values of noise reduction as though they were values of transmission loss. The NIC determined in accordance with ASTM Standard E413, *Determination of Sound Transmission Class*. It provides an estimate of the sound isolation between two enclosed spaces that are acoustically connected.

Noise reduction (NR): In a specified frequency band, the difference between the space-time average sound pressure levels produced in two enclosed spaces or one of them. Note: it is implied that in each room individual observations are randomly distributed about the average value, with no systematic variation within the position within the permissible measurement region. Noise reduction becomes meaningless and should not be used in situations where this condition is not met.

Noise reduction coefficient (NRC): A single number rating derived from measured values of sound absorption coefficients in accordance with ASTM Test Method C423, *Sound Absorption and Sound Absorption Coefficients by the Reverberation Room Method*. It provides an estimate of the sound absorptive property of an acoustical material. NRC values range from 0 for hard, reflective materials such as flat glass and gypsum board to 1.2 for several inches of highly efficient fiberglass.

Octave band: A range of frequency where the highest frequency of the band is double the lowest frequency of the band. The band is usually specified by the center frequency.

Reverberation: The persistence of sound in an enclosed or partially enclosed space after the source of the sound has stopped.

Reverberation time: The time required for the average sound intensity of an enclosed space to decrease by 60 dB after the sound source becomes silent.

Sabin: The unit of measure of sound absorption in the inch-pound system.

Sound absorption average (SAA): A single number rating similar to the NRC used to express the sound absorbing properties of a material. It is equal to the average of the sound absorption coefficients of a material from 200 through 2500 Hz.

Sound absorption coefficient (a, dimensionless): Metric sabin/m² of a surface, in a specified frequency band. The measure of the absorptive property of a material as approximated by ASTM Test Method C423, *Sound Absorption and Sound Absorption Coefficients by the Reverberation Room Method*. Ideally, the fraction of the randomly incident sound power level absorbed or not otherwise reflected.

Sound attenuation: (1) The reduction of the intensity of a sound as it travels from the source to a receiving location. Sound absorption is often involved as, for instance, in a lined air duct. (2) Spherical spreading and scattering or other attenuation mechanisms.

Sound level meter: An instrument that measured sound pressure levels with a microphone which converts sound pressure waves to an electrical signal.

Sound pressure level (Lp): Of airborne sound, ten times the common logarithm of the ratio of the square of the sound pressure under consideration to the square of the standard reference pressure of 20 microPa. The quantity so obtained is expressed in decibels.

Sound transmission class (STC): A single number rating derived from measured values of transmission in accordance with ASTM Classification E413, *Determination of Sound Transmission Class*. It provides an estimate of the performance of a partition in certain common sound insulation problems.

Sound transmission loss (STL): Of a partition, in a specified frequency band, the times the common logarithm of the ratio of the airborne sound power incident on the partition to the sound power transmitted by the partition and radiated on the other side. The quantity so obtained is expressed in decibels. Note: Unless qualified, the term denotes the sound transmission loss obtained when the specimen is exposed to a diffuse sound field as approximated in reverberation rooms meeting the requirements of ASTM Test Method E90, *Laboratory Measurement of Airborne Sound Transmission Loss of Building Partitions*.

Speech intelligibility: The proportion of meaningful speech that is correctly interpreted by a listener.

Structureborne sound: Sound that arrives at the point of concern by propagation through a solid structure.

“Let the word be heard.” Anne Seltz, Audiologist

Worksheet for calculation of room noise reduction and reverberation time. Noise reduction in a room due to the addition of sound absorption:

A. Calculation of sabins in room before sound absorption is added

1. Area of various walls: _____
2. Absorption coefficient: _____
3. Sabins (1x2): _____
4. Area of floor: _____ x Absorption coefficient = _____ sabins
5. Area of ceiling: _____ x Absorption coefficient = _____ sabins
6. Sabins of other surfaces in the room (area x abs. coeff.): _____
7. Total sabins in room: _____ sabins

B. Calculation of sabins in room after sound absorption is added

1. Area of various walls: _____
2. Absorption coefficient: _____
3. Sabins (1x2): _____
4. Area of floor: _____ x Absorption coefficient = _____ sabins
5. Area of ceiling: _____ x Absorption coefficient = _____ sabins
6. Sabins of other surfaces in the room (area x abs. coeff.): _____
7. Total sabins in room: _____ sabins

C. Calculation of noise reduction

1. Divide value in line B.7 by A.7
2. Take the logarithm to the base 10 of the result from C.1
3. Multiply the value from C.3 by 10
4. The result is the amount of noise reduction in dB at the chosen frequency

D. Calculation of reverberation time in a room

1. Calculate the volume of the room in cubic feet.
2. Multiply the volume of the room by 0.049
3. Determine the total amount of sabins in the room (see above calculations for determining sabins in a room)
4. Divide the value from line 2 by the value from line 3. This is the reverberation time in seconds.

Fire Rated Wall Assemblies — these drawings are a useful aid for fire rated wall assemblies

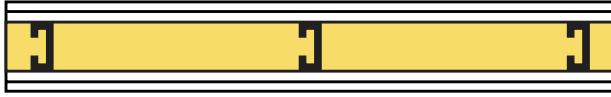

Rating: 2 hour non-bearing (U 419)
 Double layer 1/2" CertainTeed gypsum board
 2-1/2" steel studs on 24" centers
 2-1/2" CertainTeed fiberglass insulation

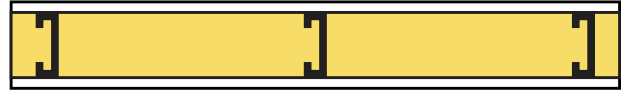

Rating 1 hour non-bearing (U 465)
 Single layer 5/8" CertainTeed gypsum board
 3-5/8" steel studs on 24" centers
 3-1/2" CertainTeed fiberglass insulation

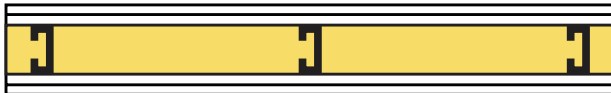

Rating: 2 hour non-bearing (U 411)
 Double layer 5/8" CertainTeed gypsum board
 Min. 2-1/2" steel studs on 24" centers
 2-1/2" CertainTeed fiberglass insulation



Rating 1 hour non-bearing (U 419)
 Single layer 5/8" CertainTeed gypsum board
 3-5/8" steel studs on 24" centers
 3-1/2" CertainTeed fiberglass insulation

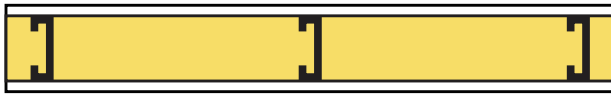

Rating: 1 hour non-bearing (U 419)
 Single layer 5/8" CertainTeed gypsum board
 Min. 3-1/2" steel studs on 24" centers
 3-1/2" CertainTeed fiberglass insulation



Rating: 2 hour non-bearing (U 411 or U 419)
 Double layer 5/8" CertainTeed gypsum board
 3-5/8" steel studs on 24" centers
 3-1/2" CertainTeed fiberglass insulation

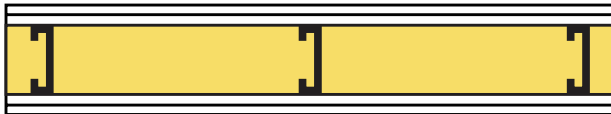

Rating: 2 hour non-bearing (U 419)
 Double layer 1/2" CertainTeed gypsum board
 3-5/8" steel studs on 24" centers
 3-1/2" CertainTeed fiberglass insulation

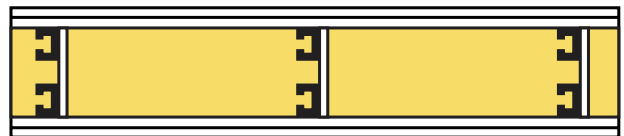

Rating: 1 hour non-bearing (U 436)
 Chase wall: Double layer 5/8" CertainTeed
 gypsum board
 1-5/8" steel studs on 24" centers CertainTeed
 fiberglass insulation to fill cavity



Rating: 1 hour non-bearing (U 465 or U 419)
 Single layer 5/8" CertainTeed gypsum board
 3-5/8" steel studs on 24" centers
 3-1/2" CertainTeed fiberglass insulation

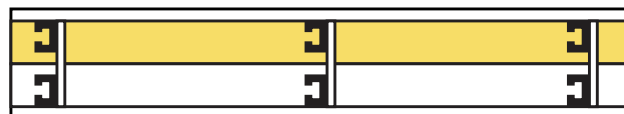

Rating: 1 hour non-bearing (U 420)
 Chase wall: Single layer 5/8" CertainTeed
 gypsum board
 1-5/8" steel studs on 24" centers CertainTeed
 fiberglass insulation to fill cavity

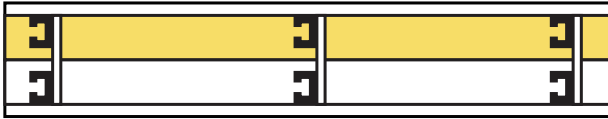

Rating: 2 hour non-bearing (U 420)

Chase wall: Double layer 5/8" CertainTeed gypsum board
 1-5/8" steel studs on 24" centers
 3-1/2" CertainTeed fiberglass insulation



Rating: 2 hour non-bearing (U 497)

Shaft wall: Single layer 1" Type FSW gypsum board one side, double layer 1/2" Type FSW-G gypsum board other side
 2-1/2" steel I studs on 24" centers
 1-1/2" CertainTeed CertaPro partition insulation



Rating: 2 hour non-bearing (U 498)

Shaft wall: Double layer (1" CertainTeed + 1/2" Type FSW) gypsum board on one side, single layer 1/2" Type FSW-G gypsum board on other side
 2-1/2" steel I studs on 24" centers
 1-1/2" CertainTeed CertaPro partition insulation



Rating: 2 hour non-bearing (U 498)

Shaft wall: Double layer (1" CertainTeed + 1/2" Type FSW) gypsum board on one side, single layer 1/2" Type FSW-G gypsum board on other side
 2-1/2" steel I studs on 24" centers
 1-1/2" CertainTeed CertaPro partition insulation

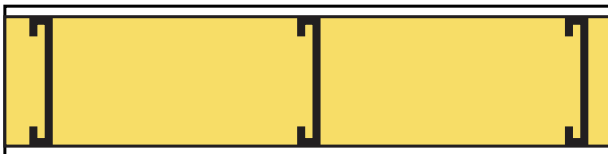

Rating: 1 hour non-bearing (U 465 or U 419)

Single layer 5/8" CertainTeed gypsum board on each side
 6" steel studs on 24" centers
 6-1/4" CertainTeed fiberglass insulation

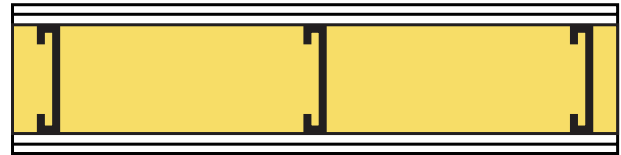

Rating: 2 hour non-bearing (U 419)

Double layer 5/8" CertainTeed gypsum board on each side
 6" steel studs on 24" centers
 6-1/4" CertainTeed fiberglass insulation



Rating: 3/4 hour bearing (U 317)

Single layer 1/2" CertainTeed gypsum board on each side
 2"x4" wood studs on 16" centers
 3-1/2" CertainTeed fiberglass insulation



Rating: 1 hour bearing (U 305)

Single layer 5/8" CertainTeed gypsum board on each side
 2"x4" wood studs on 16" centers
 3-1/2" CertainTeed fiberglass insulation

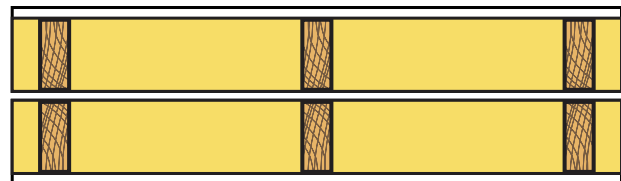

Rating: 1 hour bearing (U 341)

Single layer 5/8" CertainTeed gypsum board on each side
 2"x4" double wood studs on 24" centers
 2 layers 3-1/2" CertainTeed fiberglass insulation

Note: Drawings for illustration purposes only. Refer to Underwriters Laboratories Fire Resistance Directory for assembly details and other options.

Create a More Comfortable Home

At CertainTeed, we believe in a higher level of comfort. We believe in Complete Comfort, where your insulation system successfully controls thermal performance, air tightness, moisture management, and acoustics. That's why we offer a complete line of high performance insulation products that work together to ensure every building achieves Complete Comfort.

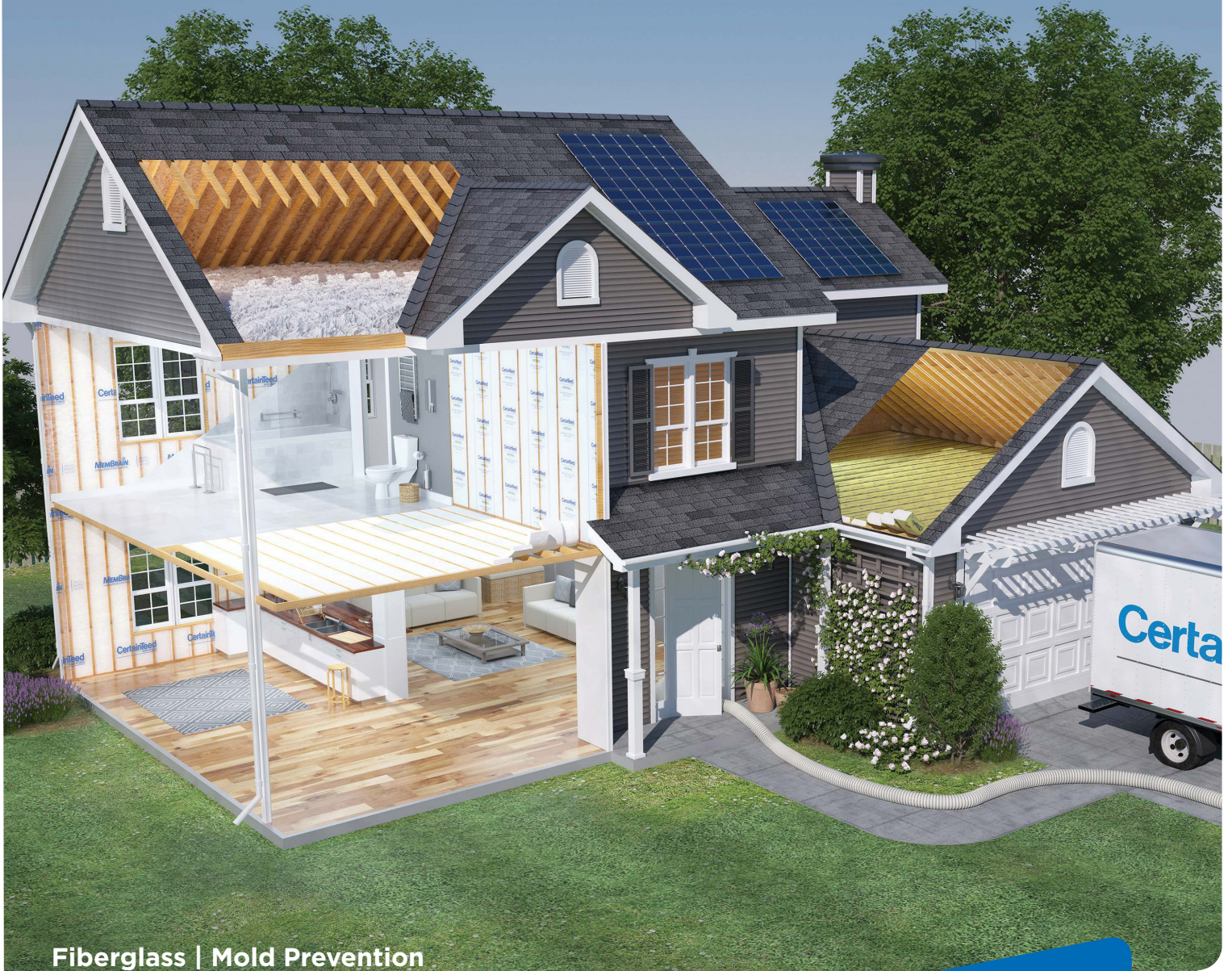

Fiberglass | Mold Prevention
Technical | Equipment

 **certainteed**
SAINT-GOBAIN

Ceilings • Decking • Fence • Gypsum
Insulation Railing • Roofing • Siding • Trim

20 Moores Road, Malvern, PA 19355
Professional: 800-23-8990
Consumer: 800-782-8777
certainteed.com



learn more at: certainteed.com/insulation

