

# ICC-ES Evaluation Report

ESR-3537

Reissued June 2024

This report also contains:

- CBC Supplement

Subject to renewal June 2025

ICC-ES Evaluation Reports are not to be construed as representing aesthetics or any other attributes not specifically addressed, nor are they to be construed as an endorsement of the subject of the report or a recommendation for its use. There is no warranty by ICC Evaluation Service, LLC, express or implied, as to any finding or other matter in this report, or as to any product covered by the report.

Copyright © 2024 ICC Evaluation Service, LLC. All rights reserved.

<p><b>DIVISION: 07 00 00— THERMAL AND MOISTURE PROTECTION</b></p> <p><b>Section: 07 31 13— Asphalt Shingles</b></p>	<p><b>REPORT HOLDER: CERTAINTEED LLC</b></p>	<p><b>EVALUATION SUBJECT: CERTAINTEED ASPHALT SHINGLES</b></p>	
---	--	--	---

## 1.0 EVALUATION SCOPE

### Compliance with the following codes:

- 2021, 2018, 2015, 2012, and 2009 [International Building Code® \(IBC\)](#)
- 2021, 2018, 2015, 2012, and 2009 [International Residential Code® \(IRC\)](#)
- 2013 *Abu Dhabi International Building Code (ADIBC)*<sup>†</sup>

<sup>†</sup>The ADIBC is based on the 2009 IBC. 2009 IBC code sections referenced in this report are the same sections in the ADIBC.

### Properties evaluated:

- Weather resistance
- Fire classification
- Wind resistance

## 2.0 USES

The CertainTeed asphalt shingles described in this report are alternatives to asphalt shingles complying with IBC Section 1507.2 and IRC Section R905.2, and are Class A roof coverings when installed as described in this report.

## 3.0 DESCRIPTION

### 3.1 General:

CertainTeed asphalt shingles are available as three-tab, four-tab, no cut-out and laminated asphalt shingle roof covering materials, and have been qualified for wind resistance as noted in Section 4.3. See [Table 1](#) and [Figure 1](#) for recognized product names, shingle types, manufacturing locations, overall dimensions, installed weights, maximum exposure to the weather, and fastening details. The shingles are self-sealing by means of adhesive strips located on either the weather side or the underside. See [Figure 1](#) for adhesive strip location for field shingles and Starter Strip shingles.

### 3.2 Three-tab Shingles, Four-tab Shingles and No Cut-out Shingles:

Three-tab, four-tab and no cut-out shingles are composed of a single layer of fiberglass mat, impregnated and coated with asphalt on both sides, and surfaced with mineral roofing granules on the weather side and a mineral release agent on the back side.

### 3.3 Laminated Shingles:

Laminated shingles, including two-layer laminated, three-layer laminated and tri-laminate laminated shingles, are composed of multiple thicknesses of coated and surfaced fiberglass mat, cut and bonded together in different patterns. The weather side is surfaced with mineral roofing granules, and the back side is surfaced with a mineral release agent.

### 3.4 Accessory Shingles:

**3.4.1 Hip and Ridge Shingles:** Hip and ridge shingles are factory-made shingles to be used for covering hips and ridges. The hip and ridge shingles are composed of the same materials as the roof shingles. Some of the hip and ridge shingles have perforations that extend from the top of the cut-out to the top of the shingle, which facilitate the tearing of the shingle into three or four equal pieces. Others are manufactured as single hip and ridge units.

**3.4.2 Starter Strip Shingles:** Starter Strip shingles are factory-made shingles to be used as the starter course (under the first course of roof shingles). The Starter Strip shingles are composed of the same materials as the roof shingles. The shingles are supplied in 7-inch-by-36-inch-long (178 by 914 mm); 10-inch-by-36-inch-long (254 by 914 mm); or 7-inch-by-39<sup>3</sup>/<sub>8</sub>-inch-long (178 by 1000 mm) strips. As an alternative to factory-made starter strips, starter strips can be formed by removing the lower tab portions of the factory-made shingles, except in the case of the Presidential Shake and Presidential Shake TL shingles. For Presidential Shake and Presidential Shake TL shingles, the Presidential Starter shingles consist of one 13<sup>1</sup>/<sub>4</sub>-inch-wide-by-40-inch-long (337 mm by 1016 mm) base shingle and one 11<sup>1</sup>/<sub>4</sub>-inch-wide-by-40-inch-long (286 mm by 1016 mm) base shingle.

### 3.5 Fasteners:

Fasteners must comply with ASTM F1667 and must be minimum No. 12 gage [0.105-inch-diameter (2.67 mm)] shank, <sup>3</sup>/<sub>8</sub>-inch-diameter-head (9.5 mm), galvanized steel, stainless steel, aluminum or copper roofing nails. Fasteners must be of sufficient length to penetrate into the sheathing <sup>3</sup>/<sub>4</sub> inch (19.1 mm), or through the sheathing, whichever is less.

### 3.6 Underlayment:

Under the 2021, 2018, 2015, 2012 and 2009 IBC, the roof underlayment must be in accordance with Section 1507.2.3. Under the 2021, 2018 and 2015 IRC, the roof underlayment must be in accordance with Section R905.1.1 and Table R905.1.1(1). Under the 2012 and 2009 IRC, the roof underlayment must be in accordance with Section R905.2.3. The roof underlayment must comply with ASTM D226 Type I or Type II, ASTM D4869 Type I or Type II, ASTM D6757 or ASTM D1970. As an alternative, a roof underlayment recognized in a current ICC-ES evaluation report as complying with AC160 or AC188 may be used, provided it is recognized as being intended for use with Class A asphalt shingles. In areas where there has been a history of ice forming along the eaves causing a backup of water, ice dam protection in accordance with 2021 and 2018 IBC Section 1507.2.7 [2015, 2012 and 2009 IBC Section 1507.2.8.2] or 2021, 2018 and 2015 IRC Section R905.2.7 [2012 and 2009 IRC Section R905.2.7.1] must be provided.

### 3.7 Asphalt Cement:

Asphalt roofing cement must comply with ASTM D4586, Type I, Class I, or Type II, Class I.

## 4.0 DESIGN AND INSTALLATION

### 4.1 New construction:

**4.1.1 General:** When installed on new construction in accordance with this section, the shingles are a Class A roof covering. The shingles must be installed in accordance with IBC Section 1507.2 or IRC Section R905.2, except as noted in this report. The roof deck must be code-complying, minimum <sup>3</sup>/<sub>8</sub>-inch-thick (9.5 mm), exterior-grade plywood; <sup>7</sup>/<sub>16</sub>-inch-thick (11.1 mm) oriented strand board (OSB); or nominally 1-inch-by-6-inch (25 by 152 mm) lumber installed as solid sheathing conforming to 2021, 2018 and 2015 IBC Section 2304.8.2 and 2308.7.10 [2012 and 2009 IBC Section 2304.7.2 or 2308.10.8]. Minimum roof slope must be 2:12 (16.7%). The maximum roof slope must be as stated in Section 4.1.2 of this report. Installation instructions are included as part of the identification label attached to each bundle of shingles. (See Section 7.0.) The roof underlayment must be as described in Section 3.6 of this report, and applied in accordance with 2021 and 2018 IBC Table 1507.1.1(2) [2015, 2012 and 2009 IBC Section 1507.2.8], or 2021, 2018 and 2015 IRC Section R905.1.1, Tables R905.1.1(2) and R905.1.1(3) and Section R905.2.3, or 2012 and 2009 IRC Section R905.2.7, as applicable.

#### 4.1.2 Application:

##### 4.1.2.1 Eave and Rake Edges of the Roof:

**4.1.2.1.1 Roof Slopes of 2:12 to 21:12 (16.7% to 175%):** Starter Strip shingles must be attached to the eave edges with four or five fasteners, equally spaced along the nail line as shown in [Figure 1](#). The Starter Strip shingles must overhang the eave and rake edges by  $\frac{1}{2}$  to  $\frac{3}{4}$  inch (12.7 to 19.1 mm).

**4.1.2.1.2 Roof Slopes Greater than 21:12 (175%):** Starter Strip shingles must be attached to the eave edges with four or five fasteners, equally spaced along the nail line as shown in [Figure 1](#). The Starter Strip shingles must overhang the eave and rake edges by  $\frac{1}{2}$  to  $\frac{3}{4}$  inch (12.7 to 19.1 mm).

**4.1.2.2 Field of the Roof:** The first course of field shingles must be installed over the starter course. Each course of shingles must be offset from the preceding course as specified in [Table 1](#). Fastening details, including number and location of fasteners, and maximum exposure to the weather, are described in [Table 1](#) and [Figure 1](#).

Methods of fastening for roof slopes of 2:12 (16.7%) to 21:12 (175%) and for roof slopes greater than 21:12 (175%) are as shown in [Figure 1](#) for the standard and high-wind applications. For slopes greater than 21:12 (175%), the shingles must also be hand-sealed as described in Section 4.1.2.4.

**4.1.2.3 High Wind Fastening:** Shingles must be fastened with four or five No. 12 gage roofing nails, described in Section 3.5, as shown in [Figure 1](#), when the shingles are installed under the following conditions:

**4.1.2.3.1 2021, 2018, 2015 and 2012 IBC:** When the roof is installed in applications where the ultimate design wind speed,  $V_{ult}$ , is 140 mph (224 km/hr) or greater.

**4.1.2.3.2 2009 IBC:** When the roof is installed in applications where the basic wind speed is 110 mph (177 km/h) or greater.

**4.1.2.3.3 2021, 2018 and 2015 IRC:** When the roof is installed in applications where the ultimate design wind speed,  $V_{ult}$ , is 140 mph (224 km/hr) or greater.

**4.1.2.3.4 2012 and 2009 IRC:** When the roof is installed in areas where the basic wind speed is 110 mph (177 km/h) or greater.

**4.1.2.4 Shingle Sealing:** In colder climates or wind regions where it is questionable whether the factory-applied adhesive will activate and seal the shingles, the shingles must be hand-sealed to the satisfaction of the code official. Hand-sealing must consist of applying a minimum of four 1-inch-diameter (25.4 mm) spots of asphalt roofing cement to the unexposed surface of the underlying course of shingles, equally spaced across each shingle. For three-tab and four-tab shingles, one spot of asphalt roofing cement must be placed under each corner of each tab (two spots per tab); the tab must then be pressed into the cement. For no cut-out shingles and laminated shingles, four equally spaced spots of asphalt roofing cement must be placed under the exposed portion of the shingle; the shingle must then be pressed into the cement.

**4.1.2.5 Hip and Ridge Shingles:** Hip and ridge shingles must be placed evenly over hips and ridges (or over shingle-over ridge vents), and fastened to the roof deck with two fasteners, located on either side of the shingle, along the nail line as shown in [Figure 1](#).

**4.1.3 Valley Construction and other Flashing:** For open valleys, corrosion-resistant metal valley flashing must be centered and placed vertically in the valley over the smooth-surfaced roof roofing, or specialty underlayment.

Corrosion-resistant metal valley flashing must be as follows:

- 2021, 2018, 2015, 2012 and 2009 IBC: A minimum of 24 inches (610 mm) wide, complying with 2021, 2018 IBC Table 1507.2.8.2 [2015, 2012 and 2009 IBC Table 1507.2.9.2].
- IRC: A minimum of 24 inches (610 mm) wide, complying with IRC Table R905.2.8.2.

Other flashing must be in accordance with IBC Sections 1503.2 and 2021 and 2018 IBC Section 1507.2.8 [2015, 2012 and 2009 IBC Section 1507.2.9] or IRC Sections R903.2 and R905.2.8, as applicable.

#### 4.2 Installation-Reroofing:

When installed over existing Class A or Class C asphalt shingle roofs in accordance with this section (Section 4.2), the shingle products are recognized as Class A roof coverings. The existing asphalt shingle roof covering must be inspected in accordance with provisions and limitations of 2021 IBC Section 1512 [2018 and 2015 IBC Section 1511 and 2012 and 2009 IBC Section 1510] or 2021, 2018 and 2015 IRC Section R908 [2012 and 2009 IRC Section R907], as applicable. Prior to the reroofing, hip and ridge covering must be

removed, and a single layer of ASTM D226, Type II, nonperforated, felt underlayment must be installed over the existing asphalt shingles. Except as noted in this section, the shingles must be installed in accordance with Section 4.1 of this report. Fasteners must be of sufficient length to penetrate  $\frac{3}{4}$  inch (19.1 mm) into the sheathing, or through the sheathing, whichever is less. Valley flashing and other flashings must comply with Section 4.1.3 of this report and the following, as applicable:

- IBC: 2021 IBC Section 1512.4 [2018 and 2015 IBC Sections 1511.5 and 1511.6 and 2012 and 2009 IBC Sections 1510.5 and 1510.6].
- IRC: 2021, 2018 and 2015 IRC Sections R908.5 and R908.6 [2012 and 2009 IRC Sections R907.5 and R907.6].

The following asphalt shingles may be installed over existing wood shingle roofs provided all of the conditions specified above are met:

Grand Manor, Carriage House, Presidential Shake TL, Presidential Shake, Presidential Shake IR, Presidential Solaris, Presidential TL Solaris, Landmark TL, Landmark Premium, Landmark Solaris, Landmark Pro Solaris, Landmark Pro, Architect 80, Landmark, Landmark IR, XT-30, XT-30 IR, XT-25, CT-20, Independence, Hatteras, Highland Slate, Highland Slate IR, NorthGate, Patriot, Shangle Ridge, Cedar Crest IR, Mountain Ridge Arcadia Shake, Belmont, Belmont IR and Shadow Ridge.

#### 4.3 Wind Resistance:

CertainTeed asphalt shingles have been tested in accordance with ASTM D7158 and are classified as Class H. They qualify for use in locations as shown in 2021 IBC Table 1504.2 [2018 and 2015 IBC Table 1504.1.1 and 2012 and 2009 IBC Table 1507.2.7.1 (1)] and 2021, 2018 and 2015 IRC Table R905.2.4.1 [2012 and 2009 IRC Table R905.2.4.1 (1)]. Installation must be in accordance with 2021 and 2018 IBC Section 1507.2.6 [2015, 2012 and 2009 IBC Section 1507.2.7] or IRC Section R905.2.6, as applicable.

## 5.0 CONDITIONS OF USE:

The CertainTeed Asphalt Shingle Roof Covering Systems described in this report comply with, or are suitable alternatives to what is specified in, those codes listed in Section 1.0 of this report, subject to the following conditions:

- 5.1 The shingles must be manufactured, identified, and installed in accordance with the applicable codes, this report, and the manufacturer's published installation instructions. If there is a conflict between the manufacturer's published installation instructions and this report, this report governs.
- 5.2 The products are manufactured in Avery, Ohio (AV); Ennis, Texas (EN); Fremont, California (FR); Jonesburg, Missouri (JB); Norwood, Massachusetts (NW); Oxford, North Carolina (OX); Peachtree City, Georgia (PT); Portland, Oregon (PO); Shakopee, Minnesota (SH); Shreveport, Louisiana (SP); and Wilmington, California (WI), under a quality-control program with inspections by ICC-ES.

## 6.0 EVIDENCE SUBMITTED

Data in accordance with the [ICC-ES Acceptance Criteria for Alternative Asphalt Roofing Shingles \(AC438\)](#), dated June 2017 (editorially revised July 2022).

## 7.0 IDENTIFICATION

- 7.1 Each bundle of shingles bears a label with the name and address of the CertainTeed LLC manufacturing plant; the product brand name; the Class A roof classification; the installation instructions; the evaluation report number (ESR-3537); and a reference indicating compliance with ASTM D7158. Additionally, each bundle of shingles is marked with the area of the roof surface covered and the style, type and color of the product.
- 7.2 The report holder's contact information is the following:

**CERTAINTEED LLC**  
**20 MOORES ROAD**  
**MALVERN, PENNSYLVANIA 19355**  
**(610) 893-6096**  
[www.certainteed.com](http://www.certainteed.com)

TABLE 1—PRODUCT DESCRIPTIONS AND MANUFACTURING LOCATIONS

PRODUCTS <sup>1</sup>	SHINGLE TYPE	PLANT LOCATION	PLANT DESIGNATION	DIMENSIONS (width x height) (inches)	MAXIMUM EXPOSURE TO THE WEATHER (inches)	LOCATION OF NAIL "LINE" <sup>2</sup> (distance above shingle butt) (inches)
Grand Manor	3-Layer Laminated	Oxford, NC	OX	36 x 18	8	8 <sup>5</sup> / <sub>8</sub>
Carriage House	2-Layer Laminated	Oxford, NC	OX	36 x 18	8	8 <sup>5</sup> / <sub>8</sub>
Presidential Shake TL	Tri-Laminate	Fremont, CA; Shakopee, MN	FR SH	40 x 14 <sup>1</sup> / <sub>4</sub>	4	9
Presidential Shake	Laminated	Fremont, CA; Shakopee, MN	FR SH	40 x 14 <sup>1</sup> / <sub>4</sub>	4	9
Presidential IR	Laminated Impact Resistant	Shakopee, MN	SH	40 x 14 <sup>1</sup> / <sub>4</sub>	4	9
Presidential Solaris	Laminated	Fremont, CA	FR	40 x 14 <sup>1</sup> / <sub>4</sub>	4	9
Presidential TL Solaris	Tri-Laminate	Fremont, CA	FR	40 x 14 <sup>1</sup> / <sub>4</sub>	4	9
Landmark TL	Tri-Laminate	Fremont, CA; Oxford, NC	FR OX	40 x 13 <sup>1</sup> / <sub>4</sub>	5 <sup>5</sup> / <sub>8</sub>	6 <sup>1</sup> / <sub>16</sub>
Landmark Premium	Laminated (Metric)	Avery, OH Norwood, MA Oxford, NC Peachtree City, GA Portland, OR Shakopee, MN Shreveport, LA Wilmington, CA	AV NW OX PT PO SH SP WI	38 <sup>3</sup> / <sub>4</sub> x 13 <sup>1</sup> / <sub>4</sub>	5 <sup>5</sup> / <sub>8</sub>	6 <sup>1</sup> / <sub>8</sub>
Landmark Solaris	Laminated (Metric)	Peachtree, GA Portland, OR Wilmington, CA	PT PO WI	38 <sup>3</sup> / <sub>4</sub> x 13 <sup>1</sup> / <sub>4</sub>	5 <sup>5</sup> / <sub>8</sub>	6 <sup>1</sup> / <sub>8</sub>
Landmark Solaris IR	Laminated (Metric) Impact Resistant	Peachtree, GA	PT	38 <sup>3</sup> / <sub>4</sub> x 13 <sup>1</sup> / <sub>4</sub>	5 <sup>5</sup> / <sub>8</sub>	6 <sup>1</sup> / <sub>8</sub>
Landmark Pro	Laminated (Metric)	Avery, OH Jonesburg, MO Norwood, MA Oxford, NC Peachtree City, GA Portland, OR Shakopee, MN Shreveport, LA Wilmington, CA	AV JB NW OX PT PO SH SP WI	38 <sup>3</sup> / <sub>4</sub> x 13 <sup>1</sup> / <sub>4</sub>	5 <sup>5</sup> / <sub>8</sub>	6 <sup>1</sup> / <sub>8</sub>
Landmark Pro Solaris	Laminated (Metric)	Wilmington, CA	WI	38 <sup>3</sup> / <sub>4</sub> x 13 <sup>1</sup> / <sub>4</sub>	5 <sup>5</sup> / <sub>8</sub>	6 <sup>1</sup> / <sub>8</sub>
Landmark IR	Laminated (Metric) Impact Resistant	Shreveport, LA	SP	38 <sup>3</sup> / <sub>4</sub> x 13 <sup>1</sup> / <sub>4</sub>	5 <sup>5</sup> / <sub>8</sub>	6 <sup>1</sup> / <sub>8</sub>
Landmark	Laminated (Metric)	Avery, OH Ennis, TX Jonesburg, MO Norwood, MA Oxford, NC Peachtree City, GA Portland, OR Shakopee, MN Shreveport, LA Wilmington, CA	AV EN JB NW OX PT PO SH SP WI	38 <sup>3</sup> / <sub>4</sub> x 13 <sup>1</sup> / <sub>4</sub>	5 <sup>5</sup> / <sub>8</sub>	6 <sup>1</sup> / <sub>8</sub>
XT-30	3-Tab (Metric)	Portland, OR	PO	39 <sup>3</sup> / <sub>8</sub> x 13 <sup>1</sup> / <sub>4</sub>	5 <sup>5</sup> / <sub>8</sub>	6 <sup>1</sup> / <sub>8</sub>
XT-30	3-Tab (Standard)	Avery, OH Oxford, NC Shakopee, MN	AV OX SH	36 x 12	5	5 <sup>5</sup> / <sub>8</sub>
XT-30 IR	3-Tab (Standard) Impact Resistant	Shreveport, LA	SP	36 x 12	5	5 <sup>5</sup> / <sub>8</sub>
XT-25	3-Tab (Metric)	Portland, OR Avery, OH	PO AV	39 <sup>3</sup> / <sub>8</sub> x 13 <sup>1</sup> / <sub>4</sub>	5 <sup>5</sup> / <sub>8</sub>	6 <sup>1</sup> / <sub>8</sub>
XT-25	3-Tab (Standard)	Avery, OH Norwood, MA Oxford, MN Shakopee, MN Shreveport, LA	AV NW OX SH SP	36 x 12	5	5 <sup>5</sup> / <sub>8</sub>
CT-20	3-Tab (Metric)	Portland, OR	OR	39 <sup>3</sup> / <sub>8</sub> x 13 <sup>1</sup> / <sub>4</sub>	5 <sup>5</sup> / <sub>8</sub>	6 <sup>1</sup> / <sub>8</sub>

For SI: 1 inch = 25.4 mm.

TABLE 1—PRODUCT DESCRIPTIONS AND MANUFACTURING LOCATIONS (Continued)

PRODUCTS <sup>1</sup>	SHINGLE TYPE	PLANT LOCATION	PLANT DESIGNATION	DIMENSIONS (width x height) (inches)	MAXIMUM EXPOSURE TO THE WEATHER (inches)	LOCATION OF NAIL "LINE" <sup>2</sup> (distance above shingle butt) (inches)
CT-20	3-Tab (Standard)	Oxford, NC Shreveport, LA	OX SP	36 x 12	5	5 <sup>5</sup> / <sub>8</sub>
Landmark Pro Architect 80	Laminated (Metric)	Portland, OR	PO	38 <sup>3</sup> / <sub>4</sub> x 13 <sup>1</sup> / <sub>4</sub>	5 <sup>5</sup> / <sub>8</sub>	6 <sup>1</sup> / <sub>8</sub>
Independence	3-Tab Laminated (Standard)	Avery, OH Oxford, NC Shakopee, MN	AV OX SH	36 x 12	5	5 <sup>5</sup> / <sub>8</sub>
Hatteras	4-Tab	Oxford, NC	OX	36 x 18	8	9 <sup>3</sup> / <sub>8</sub>
Highland Slate	4-Tab	Oxford, NC	OX	36 x 18	8	9 <sup>3</sup> / <sub>8</sub>
Highland Slate IR	4-Tab Impact Resistant	Oxford, NC	OX	36 x 18	8	9 <sup>3</sup> / <sub>8</sub>
NorthGate	Laminated (Metric), Impact resistant	Portland, OR	PO	38 <sup>3</sup> / <sub>4</sub> x 13 <sup>1</sup> / <sub>4</sub>	5 <sup>5</sup> / <sub>8</sub>	6 <sup>1</sup> / <sub>8</sub>
Patriot	No Cutout	Portland, OR Avery, OH Norwood, MA	PO AV NW	39 <sup>3</sup> / <sub>8</sub> x 13 <sup>1</sup> / <sub>4</sub>	5 <sup>5</sup> / <sub>8</sub>	6 <sup>1</sup> / <sub>8</sub>
Arcadia Shake	4-Layer Laminated	Fremont, CA	FR	37 <sup>1</sup> / <sub>2</sub> x 19 <sup>1</sup> / <sub>2</sub> <sup>3</sup>	8 <sup>1</sup> / <sub>2</sub>	9 <sup>3</sup>
Belmont	4-Tab Laminated	Oxford, NC	OX	36 x 18	8	8 <sup>5</sup> / <sub>8</sub>
Belmont IR	4-Tab Laminated Impact Resistant	Oxford, NC	OX	36 x 18	8	8 <sup>5</sup> / <sub>8</sub>

For SI: 1 inch = 25.4 mm.

NOTES:

1. Includes algae-resistant (AR) versions.
2. Nail "Line" - Distance from lowermost lowest edge of shingle to target nail location.
3. Shingle butt location varies up to 1 inch. Dimensions shown for shingle height and nail "line" location are averages.

TABLE 1—PRODUCT DESCRIPTIONS AND MANUFACTURING LOCATIONS (Continued)

ACCESSORIES					
PRODUCTS	SHINGLE TYPE	PLANT LOCATION	PLANT DESIGNATION	DIMENSIONS (width x height) (inches)	MAXIMUM EXPOSURE TO THE WEATHER (inches)
Shangle Ridge	Hip and Ridge	Oxford, NC	OX	12 x 18	8
Cedar Crest	Hip and Ridge	Oxford, NC	OX	12 x 18	8
Cedar Crest IR	Hip and Ridge Impact Resistant	Oxford, NC	OX	12 x 18	8
Mountain Ridge	Hip and Ridge	Fremont, CA	FR	8 x 12 & 10 x 12	8
NorthGate Ridge	Hip and Ridge, Impact Resistant	Portland, OR	PO	9 <sup>7</sup> / <sub>8</sub> x 13 <sup>1</sup> / <sub>4</sub>	5 <sup>5</sup> / <sub>8</sub>
Shadow Ridge	Hip and Ridge (Standard)	Avery, OH Norwood, MA Oxford, NC Shakopee, MN	AV NW OX SH	12 x 12	5
Shadow Ridge	Hip and Ridge (Metric)	Portland, OR	PO	9 <sup>7</sup> / <sub>8</sub> x 13 <sup>1</sup> / <sub>4</sub>	5 <sup>5</sup> / <sub>8</sub>
Solaris Hip and Ridge Accessory	Hip and Ridge	Portland, OR	PO	9 <sup>7</sup> / <sub>8</sub> x 13 <sup>1</sup> / <sub>4</sub>	5 <sup>5</sup> / <sub>8</sub>
Solaris Accessory	Hip and Ridge	Portland, OR	PO	13 <sup>1</sup> / <sub>8</sub> x 13 <sup>1</sup> / <sub>4</sub>	5 <sup>5</sup> / <sub>8</sub>
Solaris Accessory IR	Hip and Ridge, Impact Resistant	Portland, OR	PO	13 <sup>1</sup> / <sub>8</sub> x 13 <sup>1</sup> / <sub>4</sub>	5 <sup>5</sup> / <sub>8</sub>
Presidential Starter	Starter Shingle	Portland, OR Fremont, CA	OR FR	40 x 13 <sup>1</sup> / <sub>4</sub> , bottom layer; 40 x 11 <sup>1</sup> / <sub>4</sub> , top layer	4 (top layer)
Presidential Starter IR	Starter Shingle	Portland, OR Fremont, CA	FR	40 x 13 <sup>1</sup> / <sub>4</sub> , bottom layer; 38 x 11 <sup>1</sup> / <sub>4</sub> , top layer	4 (top layer)
High Performance Starter	Starter Shingle	Oxford, NC	OX	36 x 10	n/a
Swiftstart	Starter Shingle	Shakopee, MN	SH	38 <sup>3</sup> / <sub>4</sub> x 7 <sup>5</sup> / <sub>8</sub>	n/a
Universal Starter	Starter Shingle	Avery, OH Oxford, NC Shakopee, MN Shreveport, LA	AV OX SH SP	36 x 7	n/a

For SI: 1 inch = 25.4 mm.

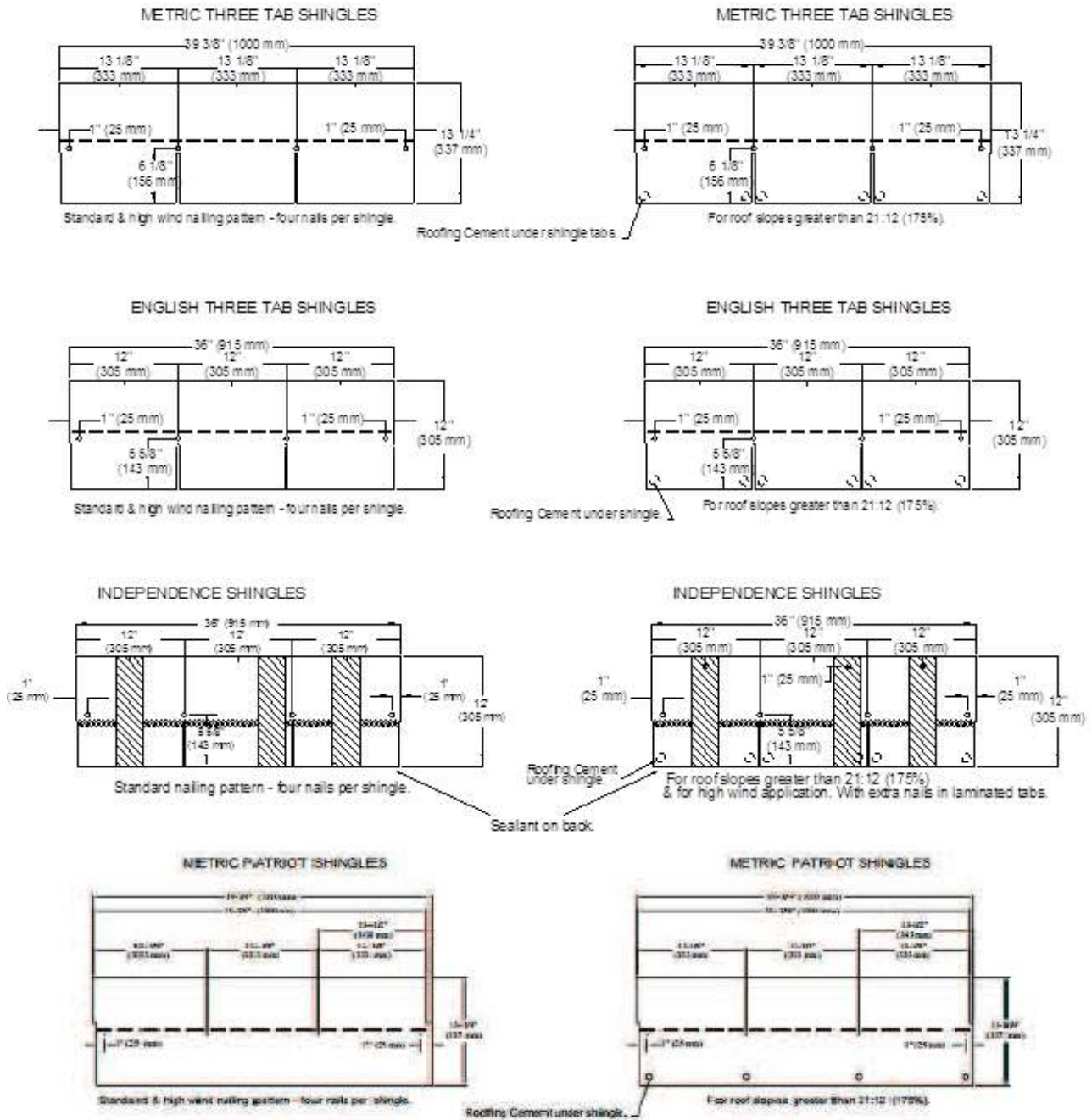

FIGURE 1—SHINGLE PROFILES AND FASTENER PATTERNS

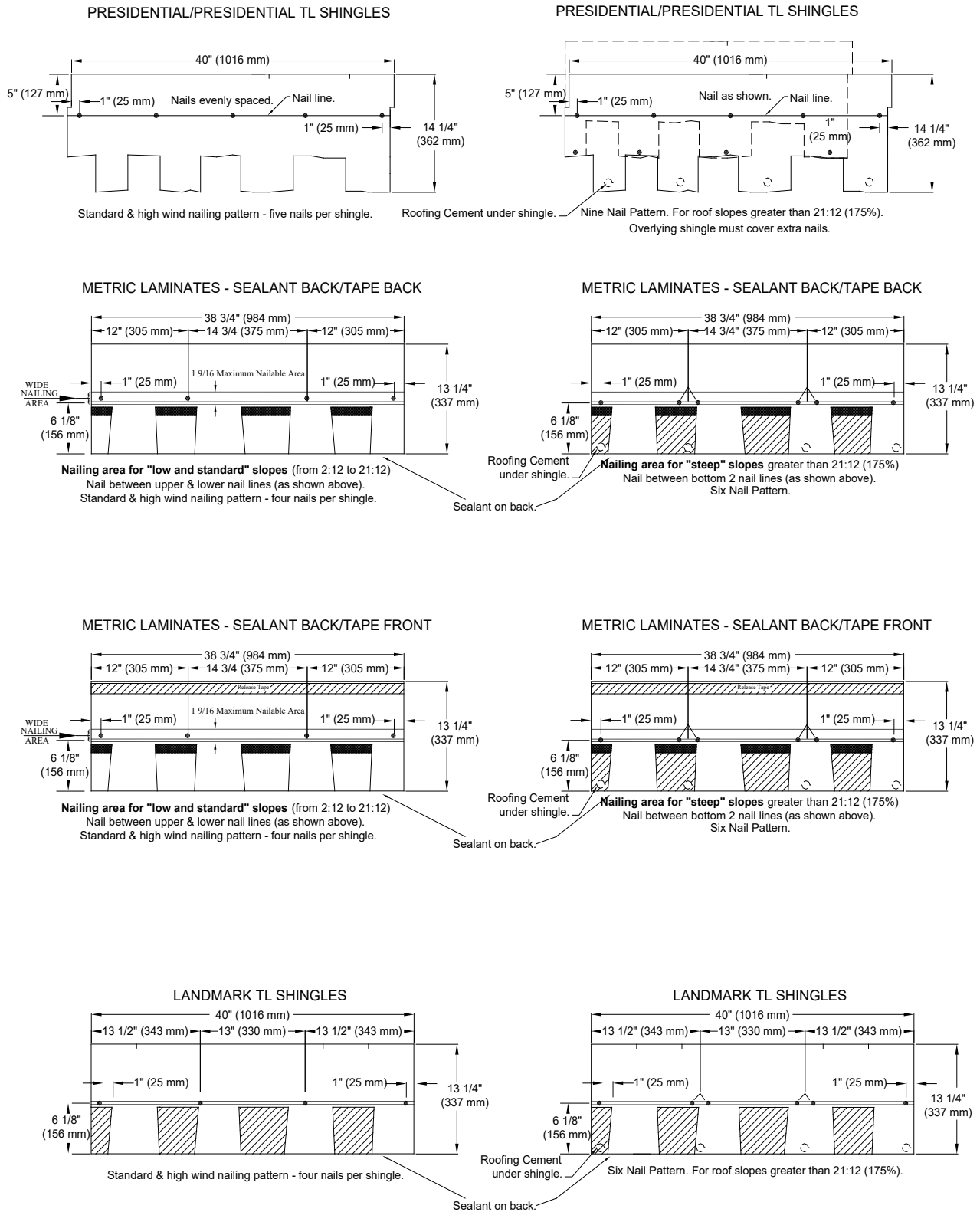

FIGURE 1—SHINGLE PROFILES AND FASTENER PATTERNS (Continued)



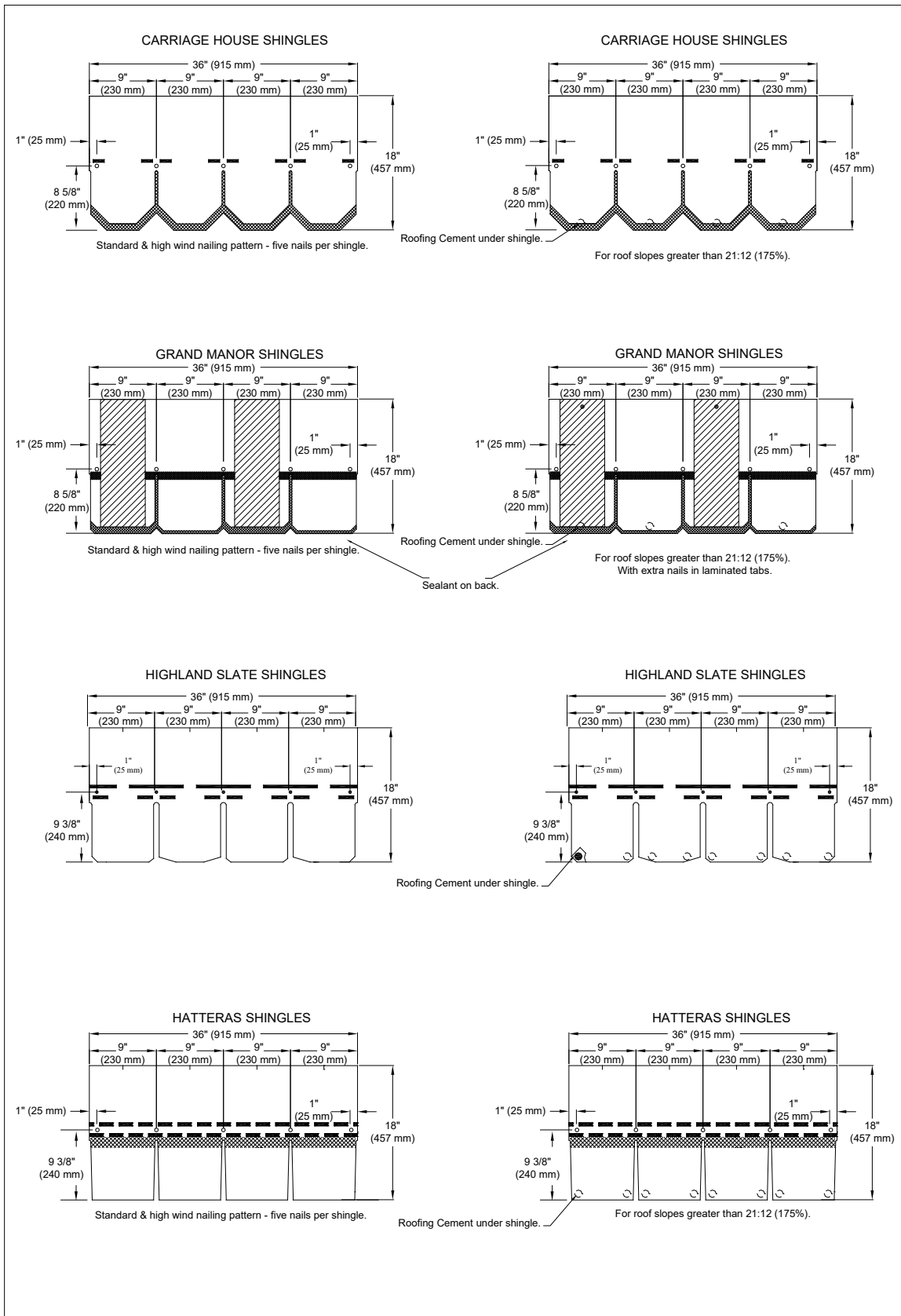
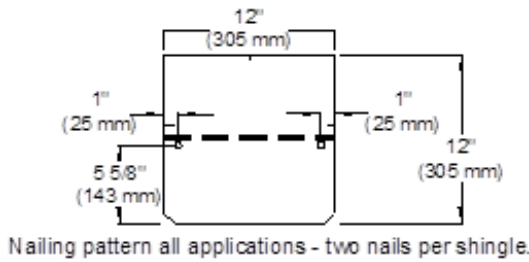
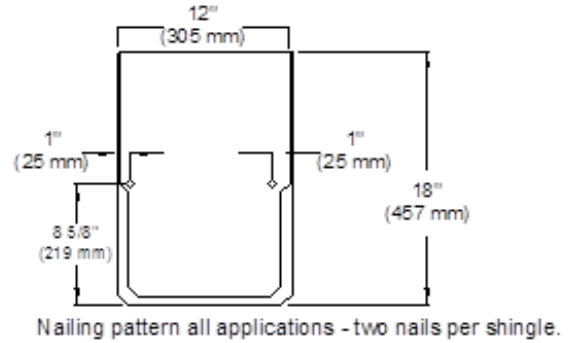

FIGURE 1—SHINGLE PROFILES AND FASTENER PATTERNS (Continued)

ENGLISH SHADOW RIDGE SHINGLES



SHANGLE RIDGE SHINGLES



METRIC SOLARIS ACCESSORY & SOLARIS ACCESSORY IR SHINGLES

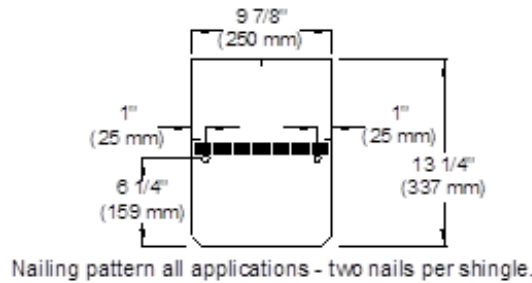

METRIC SOLARIS ACCESSORY SHINGLES & SOLARIS ACCESSORY IR SHINGLES

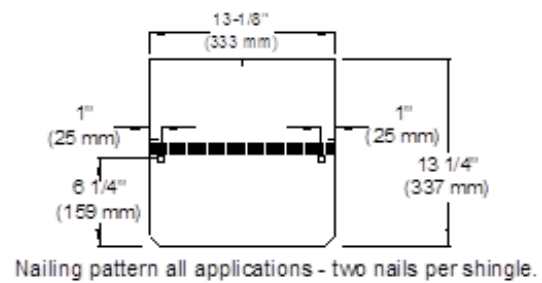

10" MOUNTAIN RIDGE SHINGLES

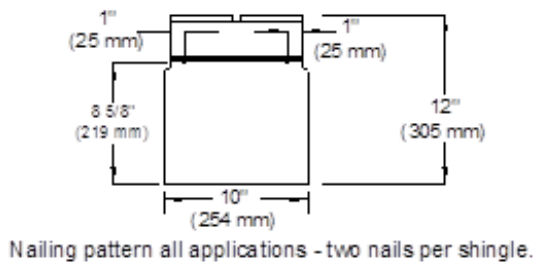

8" MOUNTAIN RIDGE SHINGLES

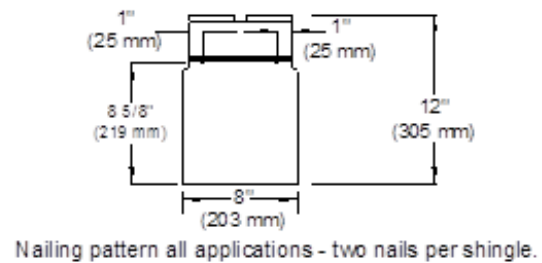

ARCADIA SHINGLES

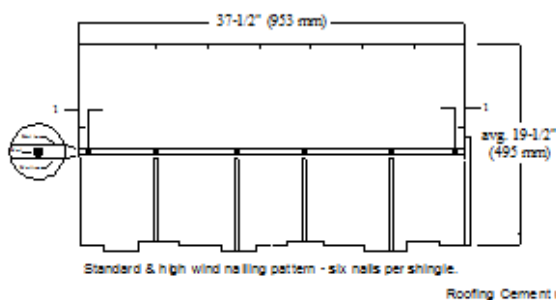

ARCADIA SHINGLES

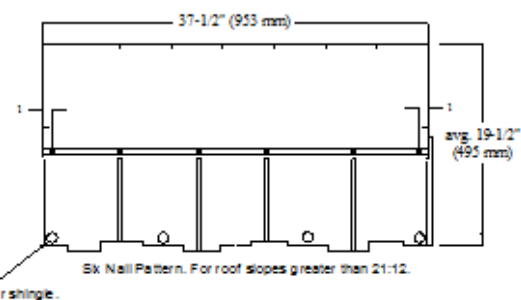

FIGURE 1—SHINGLE PROFILES AND FASTENER PATTERNS (Continued)

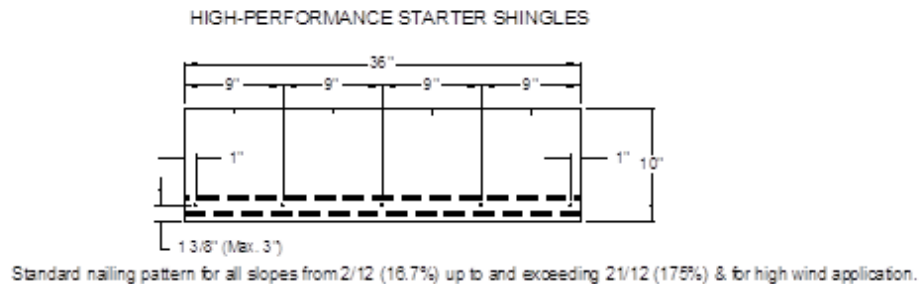
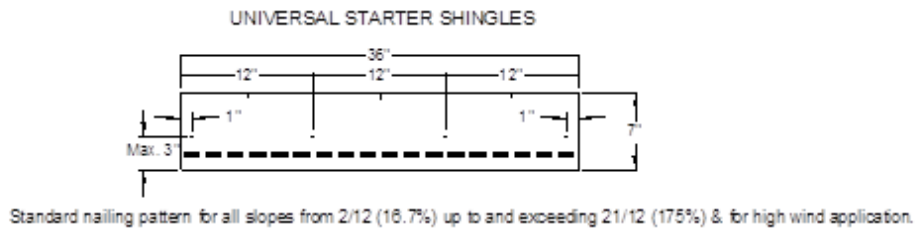
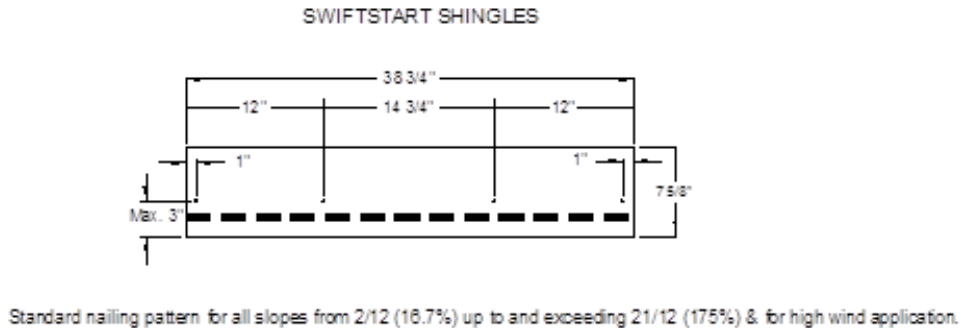
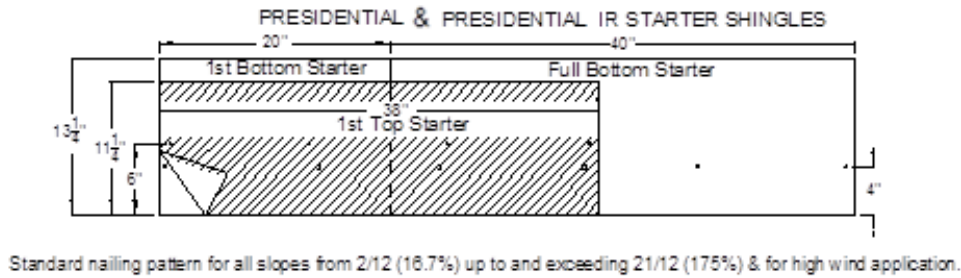
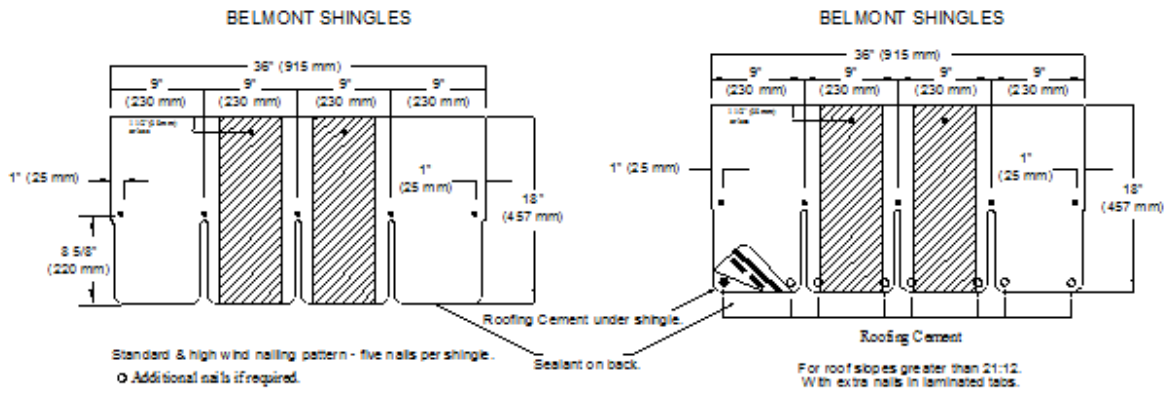

FIGURE 1—SHINGLE PROFILES AND FASTENER PATTERNS (Continued)

**DIVISION: 07 00 00—THERMAL AND MOISTURE PROTECTION**  
**Section: 07 31 13—Asphalt Shingles**

**REPORT HOLDER:**

CERTAINTEED LLC

**EVALUATION SUBJECT:**

CERTAINTEED ASPHALT SHINGLES

**1.0 REPORT PURPOSE AND SCOPE****Purpose:**

The purpose of this evaluation report supplement is to indicate that CertainTeed LLC asphalt shingles, described in ICC-ES evaluation report ESR-3537, have also been evaluated for compliance with the code(s) noted below.

**Applicable code editions:**

- 2019 *California Building Code*® (CBC)

For evaluation of applicable chapters adopted by the California Office of Statewide Health Planning and Development (OSHPD) AKA: California Department of Health Care and Information (HCAI) and the Division of State Architect (DSA), see Sections 2.1.1 and 2.1.2 below.

- 2019 *California Residential Code*® (CRC)

**2.0 CONCLUSIONS****2.1 CBC:**

The CertainTeed LLC asphalt shingles, described in Sections 2.0 through 7.0 of the evaluation report ESR-3537, comply with CBC Sections 1505.1 and 1507.2, and may be used where the CBC requires a Class A roof covering complying with CBC Section 1505.1.1, a Class B roof covering complying with CBC Section 1505.1.2, or a Class C roof covering complying with CBC Section 1505.1.3, provided the design and installation are in accordance with the 2018 *International Building Code*® (IBC) provisions respectively, noted in the evaluation report and the additional requirements of CBC Section 1511, as applicable.

**2.1.1 OSHPD:** The applicable OSHPD Sections of the CBC are beyond the scope of this supplement.

**2.1.2 DSA:** The applicable DSA Sections of the CBC are beyond the scope of this supplement.

**2.2 CRC:**

The CertainTeed LLC asphalt shingles, described in Sections 2.0 through 7.0 of the evaluation report ESR-3537, comply with CRC Sections R902.1 and R905.2, and may be used where the CRC requires a Class A roof cover complying with CRC Section R902.1.1, a Class B roof covering complying with CRC Section R902.1.2, or a Class C roof covering complying with CRC Section R902.1.3, provided the design and installation are in accordance with the 2018 *International Residential Code*® (IRC) provisions respectively, noted in the evaluation report and the additional requirements of CRC Section R908, as applicable.

This supplement expires concurrently with the report, reissued June 2024.