



**NEMO|etc.**

Certificate of Authorization #32455  
353 Christian Street, Unit #13  
Oxford, CT 06478  
(203) 262-9245

ENGINEER

EVALUATE

TEST

CONSULT

**P.E. EVALUATION REPORT (PEER)**

**CertainTeed, LLC**

20 Moores Road  
Malvern, PA 19355  
(610) 893-5400

PEER-CTR-001.A.R22

FL5444-R22 (NON-HVHZ)

Date of Issuance: 09/22/2005

Revision 22: 01/18/2024

**SCOPE:**

This P.E. Evaluation Report (henceforth 'PEER') is issued under **F.A.C Rule 61G20-3** and the applicable rules and regulations governing the use of construction materials in the State of Florida. The documentation submitted has been reviewed by Robert Nieminen, P.E. for use of the product under the Florida Building Code. The product described herein has been evaluated for compliance with the **8<sup>th</sup> Edition (2023) Florida Building Code** [sections noted herein](#).

**DESCRIPTION: CertainTeed Asphalt Roof Shingles (NON-HVHZ)**

**LABELING:** Labeling shall be in accordance with the requirements of the Accredited Quality Assurance Agency noted herein and **FBC 1507.2.7.1 / R905.2.6.1**

**CONTINUED COMPLIANCE:** This PEER is valid until such time as the named product(s) changes, the referenced Quality Assurance or production facility location(s) changes, or Code provisions that relate to the product(s) change. Acceptance of our PEERs by the named client constitutes agreement to notify NEMO ETC, LLC of any changes to the product(s), the Quality Assurance or the production facility location(s). NEMO ETC, LLC requires a complete review of its PEER relative to updated Code requirements with each Code Cycle.

**ADVERTISEMENT:** The Florida Product Approval Number (FL#) preceded by the words "NEMO P.E. Evaluated" may be displayed in advertising literature. If any portion of the PEER is displayed, then it shall be done in its entirety.

**INSPECTION:** Upon request, a copy of this entire PEER shall be provided to the user by the manufacturer or its distributors and shall be available for inspection at the job site at the request of the Building Official.

This PEER consists of pages 1 through 15.

**Prepared by:**

Digitally signed by  
**Robert Nieminen**  
Date: 2024.01.18  
'16:04:51 -05'00

This item has been digitally signed and sealed by Robert Nieminen, P.E. Printed copies of this document are not considered signed and sealed, and the signature must be verified on any electronic copies. Robert Nieminen, Florida P.E. 59166, FBC ANE1983 NEMO ETC, LLC, Florida CA #32455

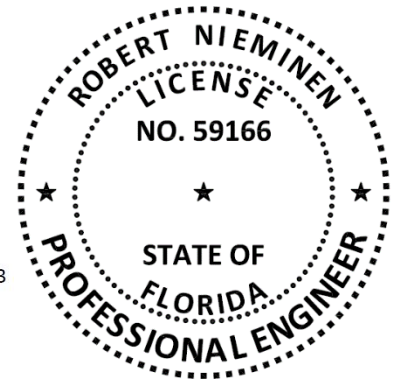

**CERTIFICATION OF INDEPENDENCE:**

1. NEMO ETC, LLC does not have, nor does it intend to acquire or will it acquire, a financial interest in any company manufacturing or distributing products it evaluates.
2. NEMO ETC, LLC is not owned, operated or controlled by any company manufacturing or distributing products it evaluates.
3. Robert Nieminen, P.E. does not have nor will acquire, a financial interest in any company manufacturing or distributing products for which the PEERs are being issued.
4. Robert Nieminen, P.E. does not have, nor will acquire, a financial interest in any other entity involved in the approval process of the product.
5. This is a building code evaluation. Neither NEMO ETC, LLC nor Robert Nieminen, P.E. are, in any way, the Designer of Record for any project on which this PEER, or previous versions thereof, is/was used for permitting or design guidance unless retained specifically for that purpose.

**ROOFING SYSTEMS EVALUATION:**
**1. SCOPE:**

**Product Category:** Roofing  
**Sub-Category:** Asphalt Shingles  
**Product Approval Method:** Method 1, Option D – Codified Material, Evaluation by Engineer  
**Compliance Statement:** **CertainTeed Asphalt Roof Shingles**, as produced by **CertainTeed, LLC**, have demonstrated compliance with the following sections of the **8<sup>th</sup> Edition (2023) Florida Building Code** through testing in accordance with the following Standards. Compliance is subject to the [Installation Requirements](#) and [Limitations of Use](#) set forth herein.

**2. STANDARDS:**

SECTION	PROPERTY	STANDARD	YEAR
1507.2.5, R905.2.4	Material standard	ASTM D3462	2016
1507.2.7.1, R905.2.6.1	Wind resistance	ASTM D3161	2016
1507.2.7.1, R905.2.6.1	Wind resistance	ASTM D7158	2019

**3. REFERENCES:**

ENTITY	EXAMINATION	REFERENCE	DATE
PRI (TST 5878)	ASTM D3161	256T0015	08/12/2019
PRI (TST 5878)	ASTM D3161	256T0069	09/10/2021
PRI (TST 5878)	ASTM D3161	256T0105	05/16/2022
UL (TST 1740)	ASTM D3161	99NK26506	11/23/1999
UL (TST 1740)	ASTM D3161	03CA12702	05/27/2003
UL (TST 1740)	ASTM D3161	03CA12702	06/16/2003
UL (TST 1740)	ASTM D3161	03NK29847	10/03/2003
UL (TST 1740)	ASTM D3161	04CA11329	05/24/2004
UL (TST 1740)	ASTM D3161	04CA32986	12/03/2004
UL (TST 1740)	ASTM D3161	05NK07049	04/15/2005
UL (TST 1740)	ASTM D3161	05NK16778	05/12/2005
UL (TST 1740)	ASTM D3161	05CA16778	05/12/2005
UL (TST 1740)	ASTM D3161	05NK14836	05/22/2005
UL (TST 1740)	ASTM D3161	05NK22800	06/22/2005
UL (TST 1740)	ASTM D3462	R684	09/21/2005
UL (TST 1740)	ASTM D7158	05NK08037	06/28/2006
UL (TST 1740)	ASTM D3161 and D3462	09CA28873	07/23/2009
UL (TST 1740)	ASTM D3462	10CA41303	10/07/2010
UL (TST 1740)	ASTM D3161	10CA41303	10/08/2010
UL (TST 1740)	ASTM D7158	10CA41303	10/27/2010
UL (TST 1740)	ASTM D3161 and D3462	10CA44960	11/11/2010
UL LLC (TST 9628)	ASTM D3161, D3462 and D7158	13CA32897	11/21/2013
UL LLC (TST 9628)	ASTM D3161, D3462	TFWZ.R684	04/22/2014
UL LLC (TST 9628)	ASTM D7158	TGAH.R684	04/22/2014
UL LLC (TST 9628)	ASTM D3161 and D3462	4786334434	09/16/2014
UL LLC (TST 9628)	ASTM D3161 and D3462	4786570826	02/12/2015
UL LLC (TST 9628)	ASTM D3161	4786821352	02/21/2015
UL LLC (TST 9628)	ASTM D3161 and D3462	4787195678	02/09/2016
UL LLC (TST 9628)	ASTM D3161, D3462 and D7158	4787592174	10/21/2016
UL LLC (TST 9628)	ASTM D3161, D3462 and D7158	4787380356	10/26/2016
UL LLC (TST 9628)	ASTM D3462	4787380357	10/13/2016
UL LLC (TST 9628)	ASTM D7158	4787380357	11/08/2016
UL LLC (TST 9628)	ASTM D3161	4787380357	11/09/2016
UL LLC (TST 9628)	ASTM D3161, D3462 and D7158	4787586427	01/25/2017
UL LLC (TST 9628)	ASTM D3161 and D3462	4788042412	11/15/2017
UL LLC (TST 9628)	ASTM D3161, D3462 and D7158	4788362767	03/03/2018
UL LLC (TST 9628)	ASTM D3161, D3462 and D7158	4786570717	02/11/2022

ENTITY	EXAMINATION	REFERENCE	DATE
UL LLC (TST 9628)	ASTM D3161, D3462 and D7158	4790438783	02/27/2022
UL LLC (TST 9628)	ASTM D3161, D3462 and D7158	4790729664	02/23/2023
UL LLC (TST 9628)	ASTM D3161, D3462 and D7158	4790746869	03/03/2023
UL LLC (TST 9628)	ASTM D3161, D3462 and D7158	4790346056	03/15/2023
UL LLC (TST 9628)	ASTM D3161, D3462 and D7158	4791057210	10/27/2023
UL LLC (QUA 9625)	Quality Control	Service Confirmation	08/08/2022
UL LLC (QUA 9625)	Quality Control	Florida BCIS	Current

**4. PRODUCT DESCRIPTION:**

TABLE 1A: STARTER STRIPS			
PRODUCT	DESCRIPTION	MATERIAL STANDARD	PLANT(S)
High-Performance Starter	Fiberglass reinforced starter shingle, measuring 10" x 36", for use with Grand Manor® and Highland Slate®	ASTM D3462	NC
Presidential® Starter	Fiberglass reinforced starter shingle, measuring 13-1/4" x 40", with a reinforcement on the underside, for use with Presidential Shake® and Presidential Shake® TL	ASTM D3462	CA(F)
Presidential® Starter IR	Fiberglass reinforced starter shingle, measuring 13-1/4" x 40", for use with Presidential Shake® IR	ASTM D3462	CA(F)
SwiftStart® Starter Shingle	Fiberglass reinforced starter strip, measuring 15-1/4" x 38-3/4"	ASTM D3462	MN
Universal Starter	Fiberglass reinforced starter shingle, measuring 7" x 36", for use with shingles measuring 12" x 36" having a weather exposure ≤ 5"	ASTM D3462	NC

TABLE 1B: ASPHALT SHINGLES			
<i>Any of the listed shingles may be produced in AR (algae resistant) versions</i>			
PRODUCT	DESCRIPTION	MATERIAL STANDARD	PLANT(S)
XT™ 25	Fiberglass reinforced, 3-tab asphalt roof shingle	ASTM D3462	LA, MN, NC, OH
XT™ 25 Metric			OH, OR
Highland Slate®	Fiberglass reinforced, laminated asphalt roof shingle	ASTM D3462	NC
Belmont®			NC
Belmont® IR			NC
Carriage House®			NC
Grand Manor®			NC
Landmark®			CA(W), GA, LA, MA, MO, MN, NC, OH, OR, TX
Landmark® ClimateFlex®			MN
Landmark® Pro			CA(W), GA, MA, MO, MN, OH, NC
Landmark® Pro Architect 80			OR
Landmark Pro Solaris®			CA(W)
Landmark® Premium			CA(W), MA, MN, OR, NC
Landmark Solaris®			CA(W), OR
Landmark® TL			CA(F)
Landmark® TL Solaris			CA(F)
NorthGate® ClimateFlex®			Fiberglass reinforced, laminated, SBS modified bitumen roof shingle
Presidential Shake®	Fiberglass reinforced, architectural asphalt roof shingle	ASTM D3462	CA(F), MN
Presidential Shake® IR			MN
Presidential Shake® TL			CA(F), MN
Presidential Solaris®			CA(F)
Presidential TL Solaris			CA(F)

<b>TABLE 1B: ASPHALT SHINGLES</b>			
<i>Any of the listed shingles may be produced in AR (algae resistant) versions</i>			
<b>PRODUCT</b>	<b>DESCRIPTION</b>	<b>MATERIAL STANDARD</b>	<b>PLANT(S)</b>
Patriot	Fiberglass reinforced asphalt roof strip-shingle; laminated appearance	ASTM D3462	OR

<b>TABLE 1C: HIP AND RIDGE SHINGLES</b>			
<b>PRODUCT</b>	<b>DESCRIPTION</b>	<b>MATERIAL STANDARD</b>	<b>PLANT(S)</b>
Shangle Ridge®	Fiberglass reinforced accessory shingles for hip and ridge installation	ASTM D3462	NC
Shadow Ridge®		ASTM D3462	MA, MN, NC, OH
Shadow Ridge® Metric		ASTM D3462	OR
Cedar Crest®		None	NC
Cedar Crest® IR		None	NC
Shadow Ridge® ClimateFlex®, 4pc		ASTM D3462	OR
Shadow Ridge® ClimateFlex®		ASTM D3462	MN

## 5. LIMITATIONS:

- 5.1 This is a building code evaluation. Neither NEMO ETC, LLC nor Robert Nieminen, P.E. are, in any way, the Designer of Record for any project on which this PEER, or previous versions thereof, is/was used for permitting or design guidance. PEERs are not to be construed as representing any attributes not specifically listed, nor are PEERs to be construed as an endorsement of the subject, or a recommendation for its use. There is no warranty by NEMO ETC, LLC or Robert Nieminen, P.E., express or implied, as to any finding or other matter in this PEER, or as to any product covered by the PEER.
- 5.2 This PEER is not for use in FBC High Velocity Hurricane Zone jurisdictions, as defined in FBC Chapter 2 (Broward and Miami-Dade Counties).
- 5.3 This PEER pertains to above-deck roof components. Roof decks and structural members shall be in accordance with FBC requirements to the satisfaction of the Authority Having Jurisdiction.
- 5.4 This PEER does not include evaluation of fire classification. Refer to **FBC 1505** for requirements and limitations regarding roof assembly fire classification. Refer to **FBC 2603** for requirements and limitations concerning the use of foam plastic insulation.
- 5.5 **Wind Classification:** Refer to [Section 6](#) for installation requirements to meet wind classifications.
- 5.5.1 **Starter Strips:**

<b>TABLE 2A: WIND CLASSIFICATIONS, STARTER STRIPS</b>		
<b>PRODUCT</b>	<b>FBC TABLE 1507.2.7.1 OR R905.2.6.1</b>	<b>NOTES</b>
High-Performance Starter	ASTM D3161, Class F	limited to use with <b>Grand Manor®</b> and <b>Highland Slate®</b> shingles
Presidential® Starter	ASTM D3161, Class F	must be applied using two (2) overlapping layers and are limited to use with <b>Presidential Shake®</b> and <b>Presidential Shake® TL</b> shingles
Presidential® Starter IR	ASTM D3161, Class F	must be applied using two (2) overlapping layers and are limited to use with <b>Presidential Shake® IR</b> shingles.
SwiftStart® Starter Shingle	ASTM D3161, Class F	
Universal Starter	ASTM D3161, Class F	limited to use with CertainTeed shingles measuring 12" x 36" having a weather exposure ≤ 5".

### 5.5.2 Asphalt Shingles:

TABLE 2B: WIND CLASSIFICATIONS, ASPHALT SHINGLES	
PRODUCT	FBC TABLE 1507.2.7.1 OR R905.2.6.1
XT™ 25, XT™ 25 Metric, Belmont®, Belmont® IR, Carriage House®, Grand Manor®, Landmark®, Landmark® ClimateFlex®, Landmark® Pro, Landmark® Pro Architect 80, Landmark Pro Solaris®, Landmark® Premium, Landmark Solaris®, Landmark® TL, NorthGate® ClimateFlex®, Presidential Shake®, Presidential Shake® IR, Presidential Shake® TL, Presidential Solaris®, Presidential TL Solaris, Highland Slate® or Patriot	ASTM D3161(F) and ASTM D7158(H)

#### 5.5.2.1 Classification by ASTM D7158:

ASTM D7158, Class H applies only to **exposure category B or C** and a **building height of 60 feet or less**. Calculations by a qualified design professional are required for conditions outside these limitations. Contact the shingle manufacturer for data specific to each shingle.

**Analysis in accordance with ASTM D7158** indicates the measured uplift resistance ( $R_T$  or  $R_A$ ) for the CertainTeed Asphalt Shingles listed in [Table 2B](#) (except *Presidential Solaris®* and *Landmark Pro Solaris®*) exceeds the calculated uplift force ( $F_T$ ) under the following conditions:

- maximum design wind speed of  $V_{asd} = 150$  mph ( $V_{ult} = 194$  mph)
- located in Exposure D conditions
- no topographical variations (flat terrain)
- having a mean roof height less than or equal to 60 feet.

The shingles (except *Presidential Solaris®* and *Landmark Pro Solaris®*) are permissible under Code for installation in these conditions using the installation procedures detailed in this PEER and CertainTeed minimum requirements, subject to minimum codified fastening requirements established within any local jurisdiction, which shall take precedence.

### 5.5.3 Hip and Ridge Shingles:

TABLE 2C: WIND CLASSIFICATIONS, HIP AND RIDGE SHINGLES		
PRODUCT	FBC TABLE 1507.2.7.1 OR R905.2.6.1	REFER TO <a href="#">SECTION 6.6</a>
Cut-shingles of XT™ 25 (produced in LA, MN, OH and OR)	ASTM D3161, Class F	Sealant required
Cut-shingles of XT™ 25 (produced in NC)	ASTM D3161, Class F	
Shangle Ridge®	ASTM D3161, Class F	Sealant required
Shadow Ridge® (MN or NC production)	ASTM D3161, Class F	
Shadow Ridge® (MA or OH production)	ASTM D3161, Class F	Sealant required
Shadow Ridge® Metric (OR production)	ASTM D3161, Class F	Sealant required
Cedar Crest®	ASTM D3161, Class F	Sealant required
Cedar Crest® IR	ASTM D3161, Class F	Sealant required
Shadow Ridge® ClimateFlex®, 4pc	ASTM D3161, Class F	
Shadow Ridge® ClimateFlex®	ASTM D3161, Class F	

5.6 All components in the roof assembly shall have quality assurance audit in accordance with **F.A.C. Rule 61G20-3**. Refer to the Product Approval of the component manufacturer for components that are produced by a Product Manufacturer other than the report holder on [Page 1](#) of this PEER.

## 6. INSTALLATION:

- 6.1 Roof deck, slope, underlayment and fasteners shall comply with **FBC 1507.2 / R905.2** and the shingle manufacturer's minimum requirements.
  - 6.1.1 Underlayment shall be acceptable to **CertainTeed, LLC** and shall hold current Florida Statewide Product Approval, or be Locally Approved in accordance with [Rule 61G20-3](#) (**FBC Sections 1507.2.3 or R905.2.3**).
- 6.2 Installation of asphalt shingles shall comply with the **CertainTeed, LLC** current published instructions, using minimum four (4) nails per shingle in accordance with **FBC 1507.2.7** or **Section R905.2.6** and the minimum requirements herein.
  - 6.2.1 Fasteners shall be in accordance with manufacturer's published requirements, but not less than **FBC 1507.2.6 or R905.2.5**. Staples are not permitted.
  - 6.2.2 Where the roof slope exceeds 21 units vertical in 12 units horizontal, use the "Steep Slope" directions.
- 6.3 CertainTeed asphalt shingles are acceptable for use in reroof (tear-off) or recover applications, subject to the limitations set forth in **FBC Section 1511 or R908** and CertainTeed published installation instructions.

## 6.4 STARTER SHINGLES:

### 6.4.1 High-Performance Starter:

Eaves: For the first starter shingle in each roof corner, use five (5) nails as shown below. All other starter shingles require four (4) nails per shingle. Nails must be of sufficient length to penetrate into the deck 3/4" or through the thickness of the decking, whichever is less. Nails are to be 11 or 12 gauge, corrosion-resistant roofing nails with 3/8" heads. Apply the 10" starter shingle with its factory-applied sealant stripes at the shingle's lower-most edge and nail firmly into the roof deck as near as possible \*(maximum 3") to the eaves edge while avoiding the sealant. With the starter shingle well fastened to the deck and the sealant low on the starter shingle, it can firmly adhere to the first course shingles. \*If nailing within 3" is not possible, nail as closely as possible, then lift and adhere the starter shingle to the underlayment and to the supporting structure with CertainTeed FlintBond™ Asphalt Roofing Cement-Caulk Grade, or approved equal.

Rakes: Prior to installation of the field shingles, starter shingles may be applied up the slope along the rake edge with sealant edge placed closest to the rake edge. Fasten as indicated below.

### HIGH-PERFORMANCE STARTER SHINGLES

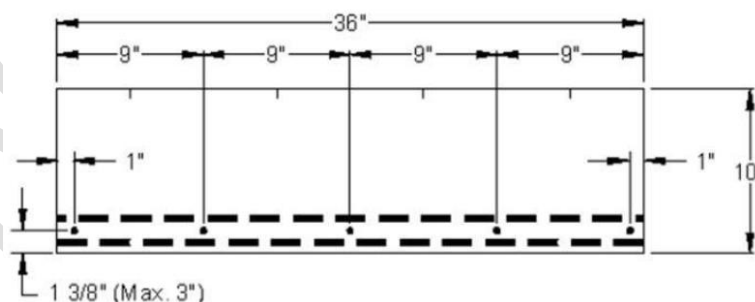

**6.4.2 Presidential® Starter and Presidential® Starter IR:**

General: These shingles shall be applied by using two (2) overlapping layers. Begin application of the bottom/lower layer of starter shingles by cutting and applying a 13-3/4" x 20" piece at the lower left rake/eaves corner overhanging rakes and eaves 1/4" to 3/4". Continue along the eaves with full-size 13-1/4" x 40" starter shingles. Each top/upper starter course shingle shall have its 2" top section removed at the perforations, resulting in 11-1/4" x 40" shingles. The colored granule portion of the "top" starter shingles shall be located nearest the lowermost eave edge. Install the first top/upper starter shingle so that it is flush to the left side and bottom edges of the first bottom/lower starter shingle. This first top/upper starter shingle shall be 11-1/4" x 38". Continue along the eaves with 11-1/4" x 40" top/upper starter shingles ensuring that the lower edges are flush with the lower edges of the bottom/lower layer. Reference the product's wrapper for more specific details.

Eaves: Fasten as shown below. Rakes: After applying the starter shingles at the eaves, but prior to installing the field shingles, starter shingles may be applied up the slope at the rake edge. Fasten as shown below.

Fastening: Four nails are required per shingle. Nails shall be of sufficient length to penetrate into the deck 3/4" or through the thickness of the decking, whichever is less. Nails are to be 11 or 12 gauge, corrosion-resistant roofing nails with 3/8" heads.

**Presidential Starter and Presidential IR Starter Shingles**

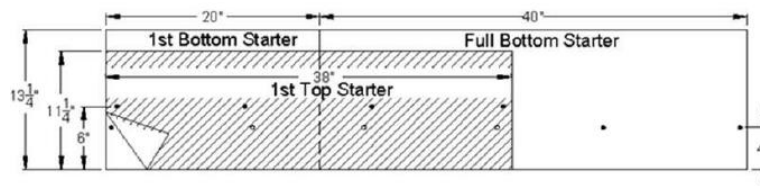

**6.4.3 Universal Starter:**

General: While Universal Starter Strip shingles are specifically designed to be used with shingles 36" length and having a weather exposure of ≤ 5", they may be installed beneath shingles of any length if special precautions are taken. **IMPORTANT:** In all cases the end joints of the starter and the first course shingles shall NEVER BE LESS THAN 3-1/2" apart.

Eaves: The sealant on starter courses should face out and lie as close as possible to the eaves edge of the roof. Fasten as described below. Rakes: After applying the starter shingles at the eaves, but prior to installing the field shingles, starter shingles may be applied up the slope at the rake edge with sealant facing out and nearest to the outer roof edge. Fasten as described below.

Fastening: Use four nails on these starter shingles as shown below. The sealant on starter courses shall lie as close as possible to the eaves edge of the roof. Nails shall be of sufficient length to penetrate into the deck 3/4" or through the thickness of the decking, whichever is less. Nails are to be 11 or 12 gauge, corrosion-resistant roofing nails with 3/8" heads.

**UNIVERSAL STARTER SHINGLES**

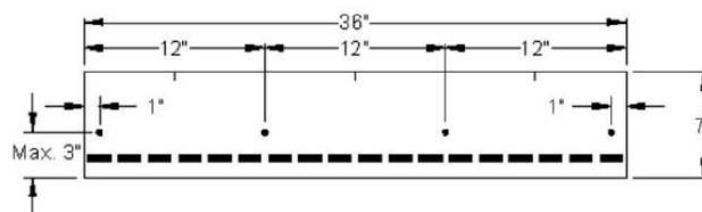

6.4.4 **SwiftStart® Starter Shingle:**

**Fastening: Use four nails, located as shown below**

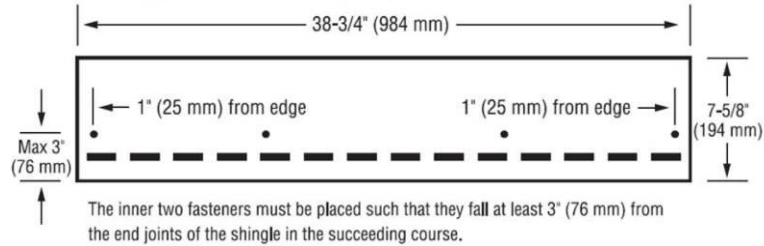

**6.5 ASPHALT SHINGLES:**

6.5.1 **XT™ 25:**

**LOW AND STANDARD SLOPE**

**ENGLISH**

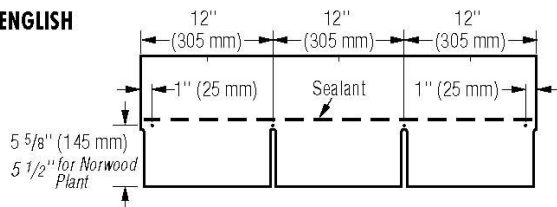

**METRIC**

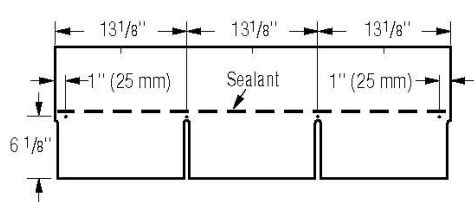
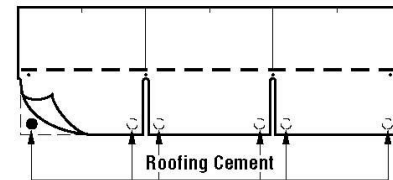

Figure 11-3: Use **four** nails for every full shingle.

**STEEP SLOPE**

Use **four** nails and six spots of asphalt roofing cement\* for every full shingle (Figure 11-4). Asphalt roofing cement meeting ASTM D4586 Type II is suggested.



Apply 1" (25 mm) spots of asphalt roofing cement under each tab corner.

Figure 11-4: Use **four** nails and **six** spots of asphalt cement on steep slopes.

**\*CAUTION:** Excessive use of roofing cement can cause shingles to blister.

6.5.1.1 **Hip and Ridge:** Cut Shingles; See [Section 6.6.1](#)



**6.5.2 Belmont® or Belmont® IR:**

**Low and Standard Slope  
(2:12 to 21:12):**

Use FIVE nails for every full Belmont shingle, located as shown below.

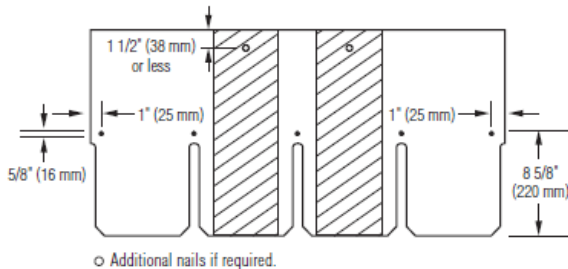

**Steep Slope (greater than 21:12):**

Use SEVEN nails and EIGHT spots of asphalt roofing cement\*\* for every full Belmont shingle. Apply asphalt roofing cement 1" (25mm) from edge of shingle. See below. Asphalt roofing cement meeting ASTM D4586 Type II is suggested.

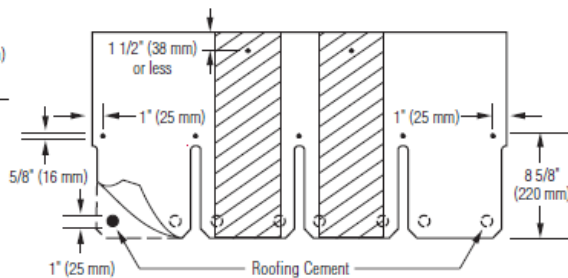

**6.5.2.1 Hip and Ridge:**

Option 1: Cedar Crest® or Cedar Crest® IR; See [Section 6.6.2](#).

Option 2: Shangle® Ridge; See [Section 6.6.3](#)

**6.5.3 Carriage House® and Grand Manor®:**

**LOW AND STANDARD SLOPE**

Use five nails for every full Shangle.

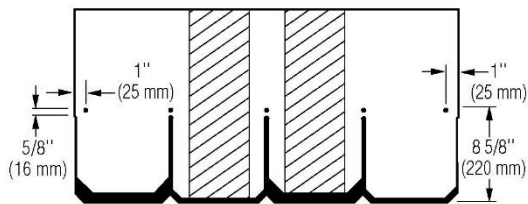

Figure 17-4: Use five nails for every full Grand Manor Shangle, Carriage House Shangle, or Centennial Slate.

**STEEP SLOPE**

Use seven nails and three spots of asphalt roofing cement for every full Grand Manor Shangle. Use five nails and three spots of asphalt roofing cement for every full Carriage House Shangle and Centennial Slate. Apply asphalt roofing cement 1" (25 mm) from edge of shingle (Figure 17-5). Asphalt roofing cement meeting ASTM D4586 Type II is suggested.

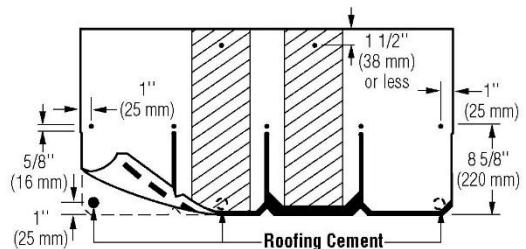
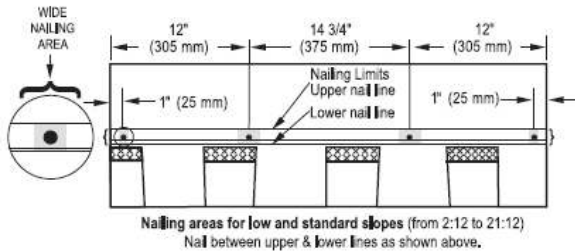

Figure 17-5: When installing Grand Manor Shangles on steep slopes, use seven nails and three spots of asphalt roofing cement.

**6.5.3.1 Hip and Ridge:** Shangle® Ridge; See [Section 6.6.3](#)

6.5.4 **Landmark®, Landmark® ClimateFlex®, Landmark® Pro, Landmark® Pro Architect 80, Landmark Pro Solaris®, Landmark® Premium, Landmark Solaris®, Landmark Solaris® IR or NorthGate® ClimateFlex®:**



**Four (4) Nail Attachment (2:12 to 21:12)**

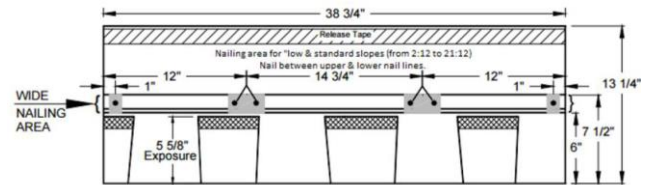

**Six (6) Nail Attachment (2:12 to 21:12)**

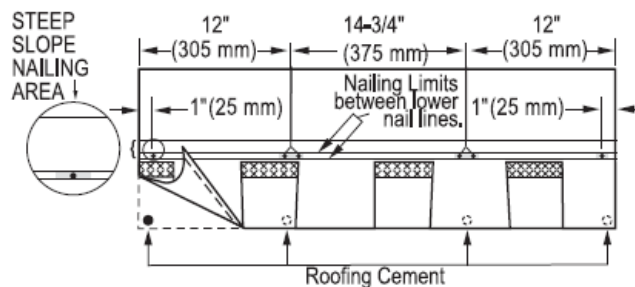

**Nailing areas for steep slopes (greater than 21:12) and "Storm-Nailing"**  
Nail between lower 2 nail lines as shown above.

**Six (6) Nail Attachment with Roofing Cement (> 21:12)**

6.5.4.1 **Sandzone:** The following asphalt roof shingles, as produced in the identified plants, are available with a 2-inch wide "sand zone" in the nailing area.

PRODUCT	PLANT(S)
Landmark® and Landmark® Pro	GA, MA, MO, MN, NC, OH
Landmark® Premium	MN, NC
Landmark® ClimateFlex® and NorthGate® ClimateFlex®	MN

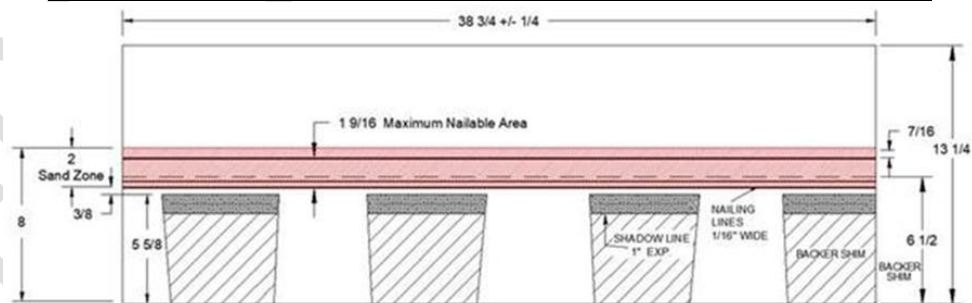

**Typical view of Landmark and NorthGate products with 2-inch Sand Zone**

6.5.4.2 **Hip and Ridge:**

Option 1: Cedar Crest® or Cedar Crest® IR; See [Section 6.6.2](#).

Option 2: Shadow Ridge® ClimateFlex®, Shadow Ridge® ClimateFlex®, 4pc or Shadow Ridge®; See [Section 6.6.4](#)

6.5.5 **Landmark® TL:**

**LANDMARK TL**

**LANDMARK TL**

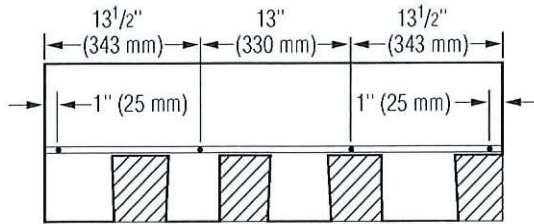

Figure 13-4: Use four nails for every full shingle.

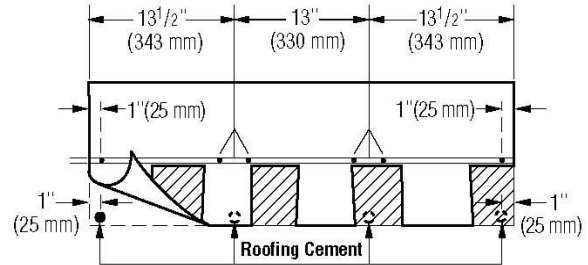

Figure 13-5: Use six nails and four spots of asphalt roofing cement on steep slopes.

6.5.5.1 **Hip and Ridge:**

Option 1: Cedar Crest® or Cedar Crest® IR; See [Section 6.6.2](#).

Option 2: Shadow Ridge® ClimateFlex® or Shadow Ridge®; See [Section 6.6.4](#)

6.5.6 **Presidential Shake®, Presidential Shake® IR, Presidential Shake® TL, Presidential Solaris®:**

**LOW AND STANDARD SLOPE:**

For low and standard slopes, use five nails for each full Presidential shingle as shown below.

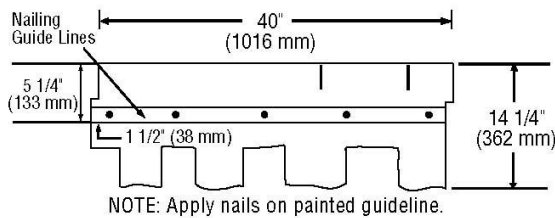

Figure 16-6: Fastening Presidential and Presidential TL Shake shingles on low and standard slopes.

**STEEP SLOPE:**

For steep slopes, use nine nails for each full Presidential shingle and apply 1" diameter spots of asphalt roofing cement under each shingle tab. After applying 5 nails in between the nailing guide lines, apply 4 nails 1" above tab cutouts making certain tabs of overlying shingle cover nails.

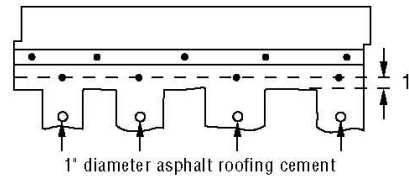

Figure 16-7: Fastening Presidential and Presidential TL Shake shingles on steep slopes.

6.5.6.1 **Hip and Ridge:** Cedar Crest® or Cedar Crest® IR; See [Section 6.6.2](#).

6.5.7 **Highland Slate®:**

**LOW AND STANDARD SLOPE:**

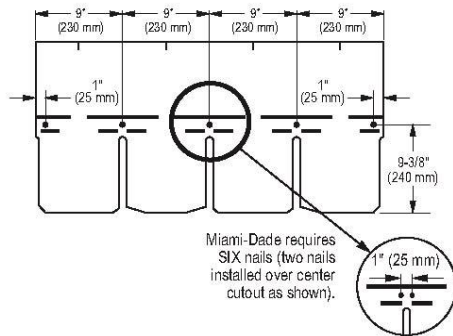

Figure 11-3: Use FIVE nails for every Highland Slate shingle.

**STEEP SLOPE:**

Use FIVE nails and EIGHT spots of asphalt roofing cement\* for each full Highland Slate shingle. For Miami-Dade, SIX nails are required. Apply 1" diameter spots of asphalt roofing cement under each tab corner. Asphalt roofing cement meeting ASTM D4586 Type II is suggested.

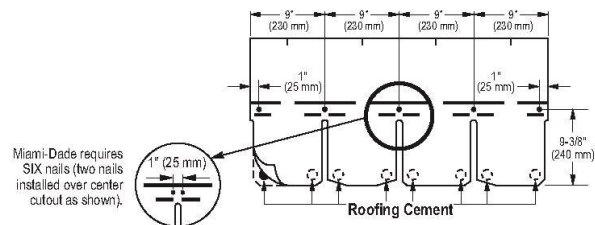

Figure 11-3A: Use FIVE nails and eight spots of asphalt roofing cement under each tab corner.

**\*CAUTION:** Excessive use of roofing cement can cause shingles to blister.

6.5.7.1 **Hip and Ridge:**

- Option 1: Cedar Crest® or Cedar Crest® IR; See [Section 6.6.2](#).
- Option 2: Shangle® Ridge; See [Section 6.6.3](#)

6.5.8 **Patriot:**

**LOW AND STANDARD SLOPE**

Use FOUR nails for every full shingle located as shown below.

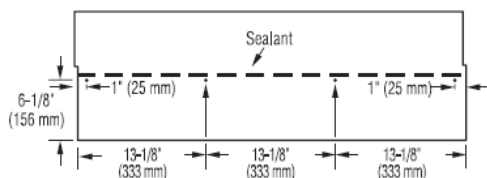

**STEEP SLOPE**

Use FOUR nails and four spots of asphalt roofing cement for every full shingle as shown below. Asphalt roofing cement meeting ASTM D4586 Type II is suggested. Apply 1" (25 mm) spots of asphalt roofing cement as shown.

**CAUTION:** Excessive use of roofing cement can cause shingles to blister.

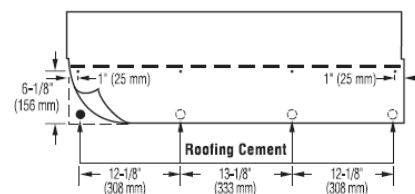

6.5.8.1 **Hip and Ridge:**

- Option 1: Cedar Crest® or Cedar Crest® IR; See [Section 6.6.2](#).
- Option 2: Shangle® Ridge; See [Section 6.6.3](#)
- Option 3: Shadow Ridge® ClimateFlex® or Shadow Ridge®; See [Section 6.6.4](#)

**6.6 HIP AND RIDGE SHINGLES:**

**6.6.1 Cut Shingles:**

**Notes:**

- Cut-shingles of XT™ 25 (produced in LA, MN, OH and OR) for hip and ridge installations require use of BASF “Sonolastic® NP1™” adhesive or Henkel “PL® Polyurethane Roof and Flashing Sealant” in accordance with CertainTeed requirements for the ASTM D3161, Class F wind rating.
- The use of the above noted sealant is optional for cut-shingles of XT™ 25 (produced in NC) for hip and ridge installations.

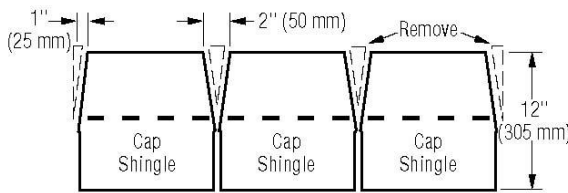

Figure 11-24: Cut tabs, then trim back to make cap shingles (English dimensions shown).

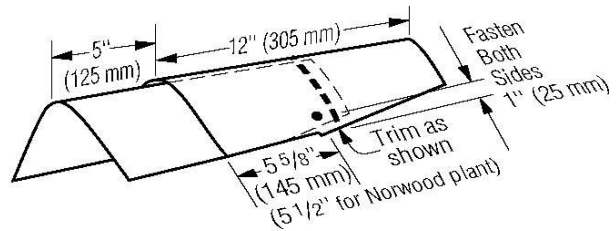

Figure 11-25: Installation of caps along the hips and ridges.

**6.6.2 Cedar Crest and Cedar Crest IR:**

**Note:** The use of BASF “Sonolastic® NP1™” adhesive or Henkel “PL® Polyurethane Roof and Flashing Sealant” in accordance with CertainTeed requirements is required for the ASTM D3161, Class F wind rating.

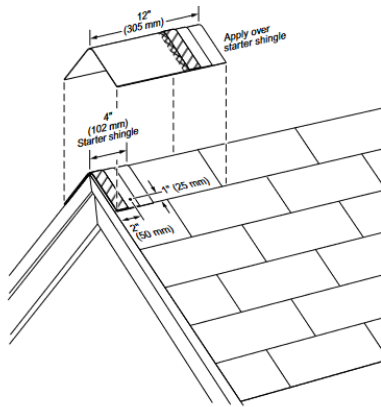

Figure 11-20: Apply a full cap shingle over the starter shingle.

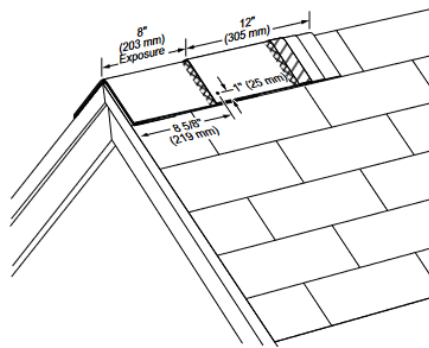

Figure 11-21: Install cap shingles at an 8" exposure and fasten with one nail on each side as shown.

**IMPORTANT: High Wind Instructions.** In order to achieve the ASTM D3161 Class “F” Wind Resistance Classification each “hip and ridge” shingle must be both 1) fastened with nails as shown and 2) hand-sealed with two ¼” wide beads of either BASF “Sonolastic® NP1™ Adhesive” or Henkel “PL® Polyurethane Roof & Flashing Cement” applied from the middle of the shingle’s raised overlay on the top piece and extending approximately 4” along the sides of the headlap along a line ¾”-1” in from each side edge of the shingle’s headlap as shown. Immediately align and apply the next overlying shingle, gently pressing tab sides into adhesive. Only one side of the double thickness tab is laminated together; to secure the other side, after folding the shingle over the ridge and nailing into position, a 1” diameter spot of either NP1 or PL adhesive must be applied between the shingle layers as shown. Immediately align and apply the next overlying shingle, gently pressing tab sides into adhesive.

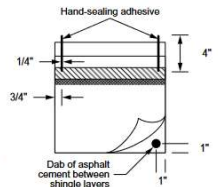

Figure 11-22: Hand seal caps as shown.

6.6.3 **Shangle Ridge:**

*Note: The use of BASF "Sonolastic® NP1™" adhesive or Henkel "PL® Polyurethane Roof and Flashing Sealant" in accordance with CertainTeed requirements is required for the ASTM D3161, Class F wind rating.*

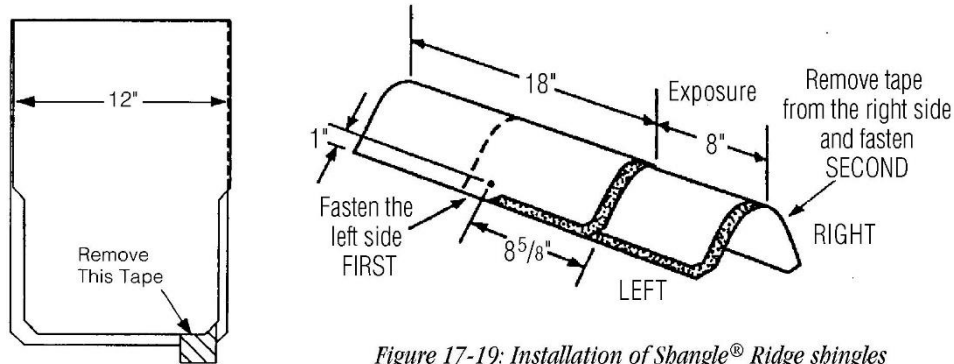
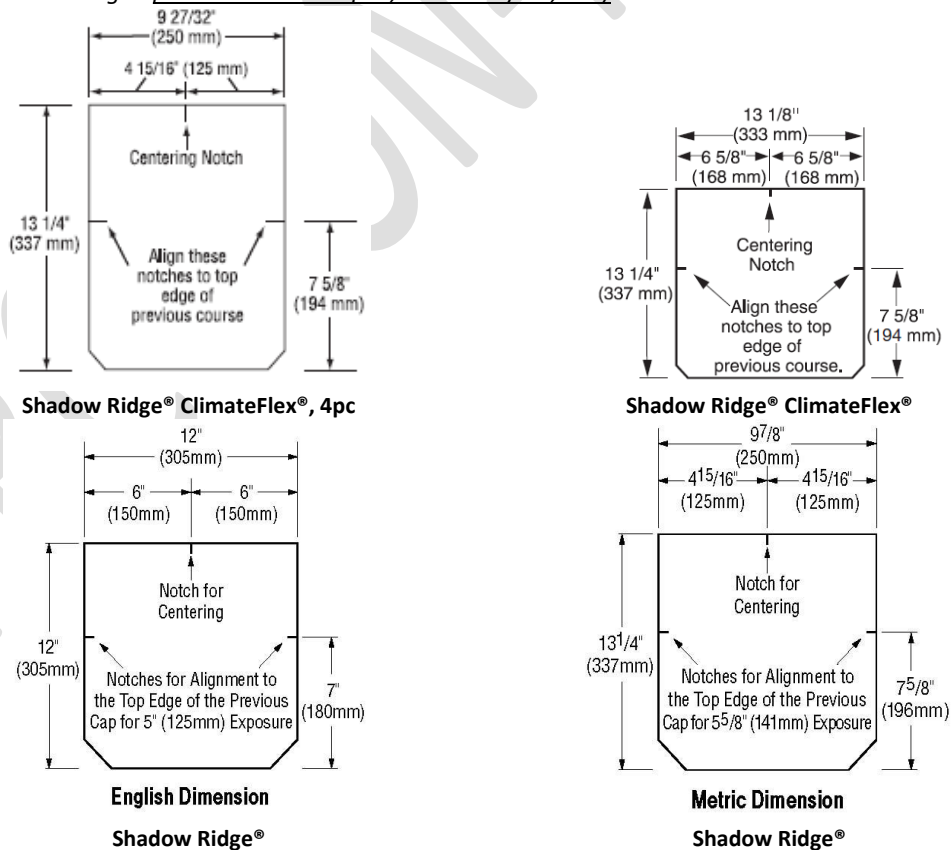

Figure 17-18: Shangle® Ridge.

Figure 17-19: Installation of Shangle® Ridge shingles on hips and ridges.

6.6.4 **Shadow Ridge® ClimateFlex®, Shadow Ridge® ClimateFlex®, 4pc or Shadow Ridge®:**

*Note: The use of BASF "Sonolastic® NP1™" adhesive or Henkel "PL® Polyurethane Roof and Flashing Sealant" in accordance with CertainTeed requirements is required for the ASTM D3161, Class F wind rating. (Use of sealant is optional for Shadow Ridge® produced in Shakopee, MN or Oxford, NC.)*



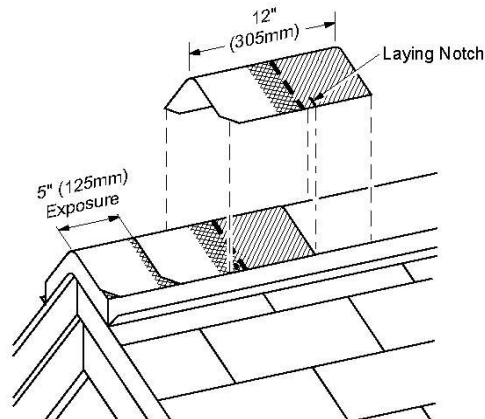

Figure 13-20: Use laying notches to center shingles on hips and ridges, and to locate the correct exposure.

#### 7. BUILDING PERMIT REQUIREMENTS:

As required by the Building Official or Authority Having Jurisdiction in order to properly evaluate the installation of this product.

#### 8. MANUFACTURING PLANTS:

Contact the named QA entity for manufacturing facilities covered by F.A.C. [Rule 61G20-3](#) QA requirements. Refer to [Section 4](#) herein for products and production locations having met codified material standards.

#### 9. QUALITY ASSURANCE ENTITY:

[UL, LLC – QUA9625](#): (360) 817-5512; [bsai.inspections@ul.com](mailto:bsai.inspections@ul.com)

- END OF PEER -