

Drift Clip (DRC6-97) for 6" Studs

97mils (12ga) Vertical / Lateral Deflection and/or Rigid Attachment

ClarkDietrich Drift Rail Clip 97mils (12ga) is a uniquely designed two-piece system that is used to attach curtain-wall studs to the building structure and allows for vertical and lateral movement or to be rigidly attached. The clip utilizes a C-Shaped Drift Rail and distinctively designed Drift Rail Clip that rotates into position for easy installation. The Drift Rail is available for mechanically anchored (DR-97) or cast-in-place (DHR-97) installations. The multifaceted Drift Rail Clips use Proprietary Deflection Screws for attachment to the wall studs and allows for 3" vertical deflection (1-1/2" up and down) and is also designed with 1/8" holes to rigidly attach wall studs. To restrict clip lateral movement (drift) along the Drift Rail, install one of the two optional drift stop locking clips (DRLA or DRLC).

Product Data & Ordering Information:

Material	Structural Grade 50 Type H (ST50H), 50ksi (340 MPa)
Rail Thickness	97mils (12ga), 0.1017" Design thickness, 0.0966" Min. thickness
Clip Thickness	97mils (12ga), 0.1017" Design thickness, 0.0966" Min. thickness
Coating	G90 (Z275) hot-dipped galvanized coating
Clip Dimensions	1" x 4-1/2" x 5-7/8" (25.4mm x 114.3mm x 203.2mm)
Rail Dimensions	1-1/8" x 3-5/8" x 12'-0" long (28.6mm x 92.1mm x 3.658m)
Assembly Standoff	7" (177.8mm)
Stop Clip Dimensions:	DRLA = 7/8" x 1" x 1" (21.8mm x 25.4mm x 25.4mm) DRLC = 7/8" x 1" x 3-5/8" (21.8mm x 25.4mm x 92.5mm)
Clip Packaging	25 clips per box. (Includes 80 proprietary deflection screws per box)
Rail Packaging	12' rail is individually packaged
Stop Clip Packaging	100 stop clips per bucket
Product weight	Clip = 1.26 lbs DR-97 Rail = 25.21 lbs DHR-97 Rail = 29 lbs

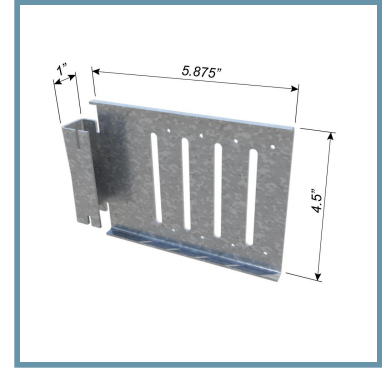

- Vertical movement up to 3" (1-1/2" up and down)
- Proprietary Deflection Screws (included) provide frictionless slip connection
- Rigid attachment to studs with #10-16 screws

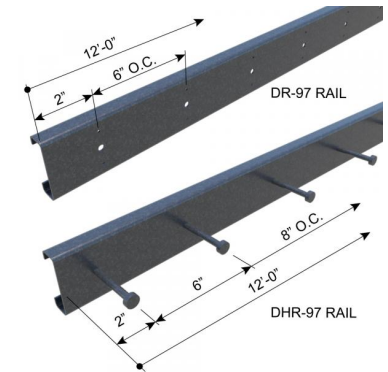
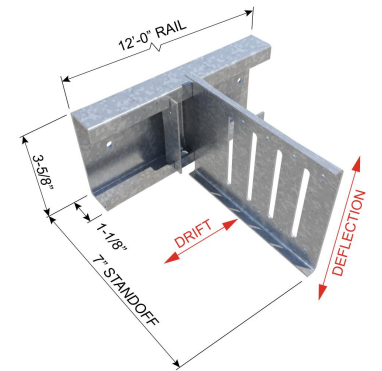

Code Approvals & Performance Standards

- [ASTM A653](#) Standard Specification for Steel Sheet, Zinc-Coated (Galvanized) or Zinc-Iron Alloy-Coated (Galvannealed) by the Hot-Dip Process
- [ASTM A1003](#) Standard Specification for Steel Sheet, Carbon, Metallic- and Nonmetallic-Coated for Cold-Formed Framing Members
- [SDS For ASTM A1003 Steel Framing Products](#) For Interior Framing, Exterior Framing and Clips/Accessories

