

8" Extended Uni-Clip™ (UXRC-8) 68mils (14ga) Extended Rigid Connection Clip

ClarkDietrich's Extended Uni-Clip rigid framing clip is used to attach exterior wall studs to the structure of the building. Designed to transfer horizontal and vertical loads, the extended rigid clips install easily with screws, powder-actuated fasteners, or welds. This clip is ideal for all medium and large standoff conditions.

Attach the Extended Uni-Clip rigid clips to cold-formed steel framing members using #12 minimum self-drilling screws driven through the clip holes into the steel framing. Follow the required fastener placement patterns to achieve the allowable load. Connections to the primary building frame can also be made with powder-actuated fasteners or welds per design requirement.

For allowable loads for multiple connection options, reference the Clip & Connector Catalog or <https://www.clarkdietrich.com/products/extended-uni-clip-uxrc> for more information.

Product Data & Ordering Information:

Material:	Structural Grade 50 Type H (ST50H), 50ksi (340 MPa)
Coating:	G90 (Z275) hot-dipped galvanized coating
Thickness:	68mils (14ga) 0.0713" Design thickness 0.0677" Minimum thickness
Dimensions:	1-7/8" x 4-7/8" x 8" (47.6mm x 124mm x 203mm)
Packaging:	25 pieces per bucket
Product Weight:	1.28 lb / piece

Code Approvals & Performance Standards

- [ASTM A653](#) Standard Specification for Steel Sheet, Zinc-Coated (Galvanized) or Zinc-Iron Alloy-Coated (Galvannealed) by the Hot-Dip Process
- [ASTM A1003](#) Standard Specification for Steel Sheet, Carbon, Metallic- and Nonmetallic-Coated for Cold-Formed Framing Members
- [SDS For ASTM A1003 Steel Framing Products](#) For Interior Framing, Exterior Framing and Clips/Accessories

Alternative Products:

- [Universal Bypass Clips \(UBC\)](#)

Sustainability Credits For more details and LEED letters contact Technical Services at 888-437-3244 or visit [clarkdietrich.com/LEED](https://www.clarkdietrich.com/LEED).

- **LEED v4.1 MR Credit:** Environmental Product Declarations: EPD (1 point) - Sourcing of Raw Materials (up to 2 points) - Material Ingredients (1 point) - Construction and Demolition Waste Management (up to 2 points)
- **LEED v4 MR Credit:** Building Product Disclosure and Optimization: EPD (1 point) - Sourcing of Raw Materials (1 point) - Material Ingredients (1 point) - Construction and Demolition Waste Management (up to 2 points) - Innovation Credit (up to 2 points).

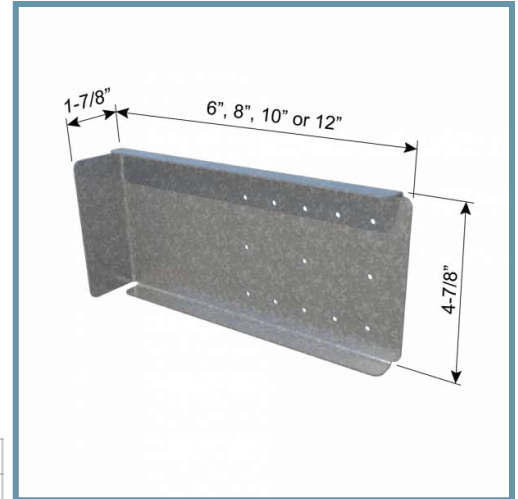

- Designed to transfer large horizontal and vertical loads
- Universal multi-application connector
- Ideal for medium and large standoff conditions

