

Fast Top™ Clips 4-3/4" (FTC5)

68mils (14ga) 4-3/4" wide vertical deflection clip

ClarkDietrich Fast Top Clips are used in head-of-wall deflection conditions for in-fill curtain wall assemblies to provide for vertical movement. These clips are used in place of or in combination with deflection track. They provide a positive attachment and do not require bridging installed continuously throughout the upper most punchouts.

The Fast Top Clip can be attached to the underside of structural members, concrete decks or floor assemblies. Studs must be cut less than full height to enable vertical movement up to 2-1/2" (1-1/4" up and down). Fast Top™ Clips install quickly with welds, screws, or powder actuated fasteners. Proprietary Deflection Screws are used to attach the clip to the cold-formed framing and to ensure frictionless deflection. These clips are also embossed with fastening patterns to ensure accurate placement of fasteners.

For allowable loads for multiple connection options, reference the Clip & Connector Catalog or www.clarkdietrich.com/products/fast-top-clip-ftc for more information.

Product Data & Ordering Information:

Material	Mill-certified SS Grade 50ksi (340 MPa)
Dimensions	1-1/2" x 4" x 4-3/4" (38.1mm x 102mm x 120mm)
Thickness	68mils (14ga), 0.0713" Design thickness, 0.0677" Min. thickness
Coating	G90 (Z275) hot-dipped galvanized coating
Packaging	30 pieces per box. Includes 110 Proprietary Deflection Screws per box.

Code Approvals & Performance Standards

- [ASTM A653](#) Standard Specification for Steel Sheet, Zinc-Coated (Galvanized) or Zinc-Iron Alloy-Coated (Galvannealed) by the Hot-Dip Process
- [ASTM A1003](#) Standard Specification for Steel Sheet, Carbon, Metallic- and Nonmetallic-Coated for Cold-Formed Framing Members
- [SDS For ASTM A1003 Steel Framing Products](#) For Interior Framing, Exterior Framing and Clips/Accessories

Alternative Products:

- [MaxTrak® Slotted Deflection Track Systems](#)

Sustainability Credits For more details and LEED letters contact Technical Services at 888-437-3244 or visit clarkdietrich.com/LEED.

- **LEED v4.1 MR Credit:** Environmental Product Declarations: EPD (1 point) - Sourcing of Raw Materials (up to 2 points) - Material Ingredients (1 point) - Construction and Demolition Waste Management (up to 2 points)
- **LEED v4 MR Credit:** Building Product Disclosure and Optimization: EPD (1 point) - Sourcing of Raw Materials (1 point) - Material Ingredients (1 point) - Construction and Demolition Waste Management (up to 2 points) - Innovation Credit (up to 2 points).

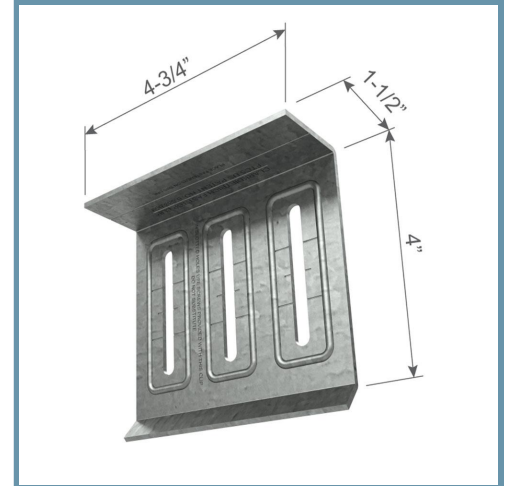

- Vertical movement up to 2-1/2" (1-1/4" up and 1-1/4" down).
- Proprietary Deflection Screws (included) provide frictionless slip connection.
- U.S. Patent No. 6,688,069

