

11-1/2" Flat Tail™ Slide Clip (FTSC6-97)

97mils (12ga) x 11-1/2" Long for 6" or 8" Studs - Vertical Deflection

ClarkDietrich's Flat Tail Slide Clip™ is used to attach exterior curtain wall studs to the building structure and provide for 2-1/4" (1-1/8" up and 1-1/8" down) vertical building movement independent of the cold-formed steel framing. A Flat Tail Slide Clip provides variable standoff and eliminates the need for shims or additional framing components. The clip easily fastens to the floor/ceiling beam and is secured to the stud with ClarkDietrich Proprietary Deflection Screws. The clip restricts lateral movement, but enables vertical building movement. **(Available in right and left versions)**

It is the responsibility of the design professional to detail the attachment of the clips and verify that their capacity meets the requirements of the intended application. For allowable loads for multiple connection options, see: www.clarkdietrich.com/FTSC

Product Data & Ordering Information:

Material:	Structural Grade 50 Type H (ST50H), 50ksi (340 MPa)
Coating:	G90 (Z275) hot-dipped galvanized coating
Thickness:	97mils (12ga) 0.1017" Design thickness 0.0966" Minimum thickness
Dimensions:	4-1/2" wide x 11-1/2" long x 4-1/4" tall
Packaging:	25 clips per bucket - Includes 160 Proprietary Deflection Screws per bucket.
Product Weight:	2.42 lb / piece

Installation:

Connection to the building can be made with screws, powder-actuated fasteners (PAFs), or by welding. Mechanical fasteners shall be located in the pilot holes. (2) Proprietary Deflection Screws are required in each slot to attach the clip to the cold-formed steel framing. Screws shall be placed in the slot with 1" center-to-center spacing using guide lines as a reference.

Code Approvals & Performance Standards

- [ASTM A653](#) Standard Specification for Steel Sheet, Zinc-Coated (Galvanized) or Zinc-Iron Alloy-Coated (Galvannealed) by the Hot-Dip Process
- [ASTM A1003](#) Standard Specification for Steel Sheet, Carbon, Metallic- and Nonmetallic-Coated for Cold-Formed Framing Members
- [SDS For ASTM A1003 Steel Framing Products](#) For Interior Framing, Exterior Framing and Clips/Accessories

Sustainability Credits For more details and LEED letters contact Technical Services at 888-437-3244 or visit clarkdietrich.com/LEED.

- **LEED v4.1 MR Credit:** Environmental Product Declarations: EPD (1 point) - Sourcing of Raw Materials (up to 2 points) - Material Ingredients (1 point) - Construction and Demolition Waste Management (up to 2 points)
- **LEED v4 MR Credit:** Building Product Disclosure and Optimization: EPD (1 point) - Sourcing of Raw Materials (1 point) - Material Ingredients (1 point) - Construction and Demolition Waste Management (up to 2 points) - Innovation Credit (up to 2 points).

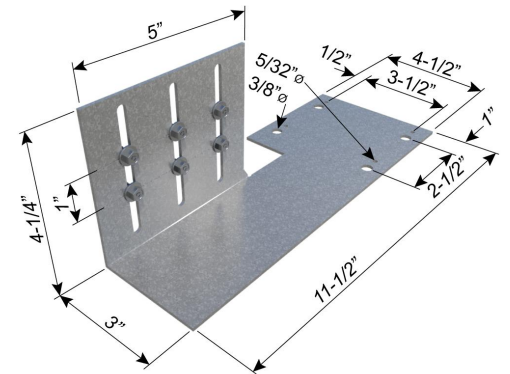
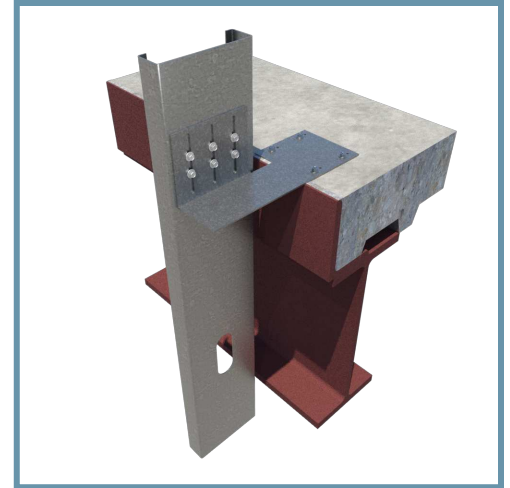

FTSC6

(RIGHT CLIP SHOWN)



**Proprietary
HD Deflection Screw**