

## TradeReady® Floor Joist Blocking (1125JB) For 11-1/4" Deep Joists

**Quick and efficient system that prevents joist rotation and accommodates mechanical passing**

TradeReady Floor Joist Blocking is one of the primary components that make up the TradeReady floor bracing system. TradeReady Blocking features a large extruded hole to accommodate HVAC, mechanical, plumbing and sprinkler runs.

TradeReady Blocking is pre-cut and formed to fit securely between the floor joists to prevent joist rotation. Pre-punched holes in the connection legs are added for quick attachment to each floor joist. Structural blocking is an economical alternative to Tension Bracing or blocking /strapping.

### Product Data & Ordering Information:

<b>Material:</b>	50ksi yield strength
<b>Coating:</b>	G90
<b>Thickness:</b>	54mils (16ga) - 0.0566" design thickness, 0.0538" minimum thickness
<b>Dimensions:</b>	Length: Based on spacing: 12", 16" or 24" long. Depth: 11-1/4" on one end same as joist depth Notched end = 9-1/4" to fit inside joist flanges Connection legs = 3" wide Hole Size = 6-1/2" x 9"
<b>Packaging:</b>	10 pieces per carton
<b>Weight:</b>	Based on length: 12" = 2.54 lbs, 16" = 3.40 lbs, 24" = 5.33 lbs / Each

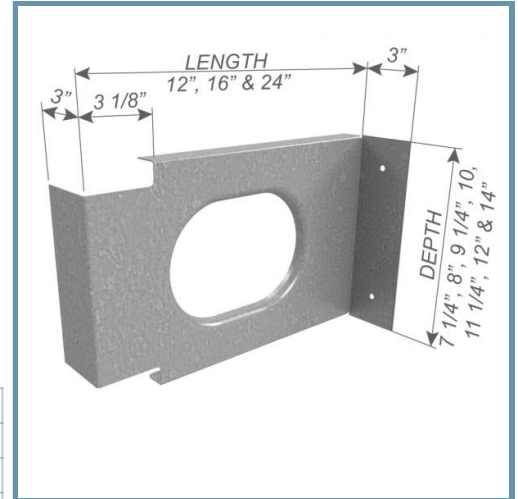

- Pre-cut to fit 12", 16", or 24" joist spacing
- Pre-punched holes for quick attachment to floor joists



### Code Approvals & Performance Standards

- [ASTM A653](#) Standard Specification for Steel Sheet, Zinc-Coated (Galvanized) or Zinc-Iron Alloy-Coated (Galvannealed) by the Hot-Dip Process
- [ASTM A1003](#) Standard Specification for Steel Sheet, Carbon, Metallic- and Nonmetallic-Coated for Cold-Formed Framing Members
- [IRC R505.3](#) Complies with International Residential Code, for solid blocking in steel floor joist systems
- [SDS For ASTM A1003 Steel Framing Products](#) For Interior Framing, Exterior Framing and Clips/Accessories

### Installation:

Place the notched end of the TradeReady Blocking inside the open side of one floor joist. Attached each end of the TradeReady Blocking to each floor joist with (2) #10-16 screws in pre-punched holes.

### Alternative Products:

- [TradeReady® Structural Bridging \(TDSB\)](#)
- [Commerical Strapping](#)
- [Flat Strapping](#)

**Sustainability Credits** For more details and LEED letters contact Technical Services at 888-437-3244 or visit [clarkdietrich.com/LEED](http://clarkdietrich.com/LEED).

- **LEED v4.1 MR Credit:** Environmental Product Declarations: EPD (1 point) - Sourcing of Raw Materials (up to 2 points) - Material Ingredients (1 point) - Construction and Demolition Waste Management (up to 2 points)
- **LEED v4 MR Credit:** Building Product Disclosure and Optimization: EPD (1 point) - Sourcing of Raw Materials (1 point) - Material Ingredients (1 point) - Construction and Demolition Waste Management (up to 2 points) - Innovation Credit (up to 2 points).