

TradeReady® Floor Joist Blocking (1200JB) For 12" Deep Joists

Quick and efficient system that prevents joist rotation and accommodates mechanical passing

TradeReady Floor Joist Blocking is one of the primary components that make up the TradeReady floor bracing system. TradeReady Blocking features a large extruded hole to accommodate HVAC, mechanical, plumbing and sprinkler runs.

TradeReady Blocking is pre-cut and formed to fit securely between the floor joists to prevent joist rotation. Pre-punched holes in the connection legs are added for quick attachment to each floor joist. Structural blocking is an economical alternative to Tension Bracing or blocking /strapping.

Product Data & Ordering Information:

Material:	50ksi yield strength
Coating:	G90
Thickness:	54mils (16ga) - 0.0566" design thickness, 0.0538" minimum thickness
Dimensions:	Length: Based on spacing: 12", 16" or 24" long. Depth: 12" on one end same as joist depth Notched end = 10" to fit inside joist flanges Connection legs = 3" wide Hole Size = 6-1/2" x 9"
Packaging:	10 pieces per carton
Weight:	Based on length: 12" = 2.68 lbs, 16" = 3.59 lbs, 24" = 5.62 lbs / Each

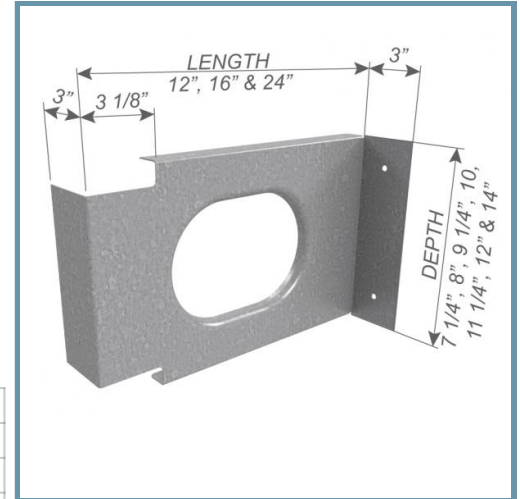

- Pre-cut to fit 12", 16", or 24" joist spacing
- Pre-punched holes for quick attachment to floor joists



Code Approvals & Performance Standards

- [ASTM A653](#) Standard Specification for Steel Sheet, Zinc-Coated (Galvanized) or Zinc-Iron Alloy-Coated (Galvannealed) by the Hot-Dip Process
- [ASTM A1003](#) Standard Specification for Steel Sheet, Carbon, Metallic- and Nonmetallic-Coated for Cold-Formed Framing Members
- [IRC R505.3](#) Complies with International Residential Code, for solid blocking in steel floor joist systems
- [SDS For ASTM A1003 Steel Framing Products](#) For Interior Framing, Exterior Framing and Clips/Accessories

Installation:

Place the notched end of the TradeReady Blocking inside the open side of one floor joist. Attached each end of the TradeReady Blocking to each floor joist with (2) #10-16 screws in pre-punched holes.

Alternative Products:

- [TradeReady® Structural Bridging \(TDSB\)](#)
- [Commerical Strapping](#)
- [Flat Strapping](#)

Sustainability Credits For more details and LEED letters contact Technical Services at 888-437-3244 or visit clarkdietrich.com/LEED.

- **LEED v4.1 MR Credit:** Environmental Product Declarations: EPD (1 point) - Sourcing of Raw Materials (up to 2 points) - Material Ingredients (1 point) - Construction and Demolition Waste Management (up to 2 points)
- **LEED v4 MR Credit:** Building Product Disclosure and Optimization: EPD (1 point) - Sourcing of Raw Materials (1 point) - Material Ingredients (1 point) - Construction and Demolition Waste Management (up to 2 points) - Innovation Credit (up to 2 points).