

2" U-Channel (CRC) 200U50-54

54mil (16ga) 33ksi

Used in framing applications:

- Furring for metal lath systems
- Drop down ceilings
- For oversized knockouts

Geometric Properties

Web Depth: 2.000 in
Leg Width: 0.500 in

Design Thickness: 0.0566 in
Min. steel thickness: 0.0538 in

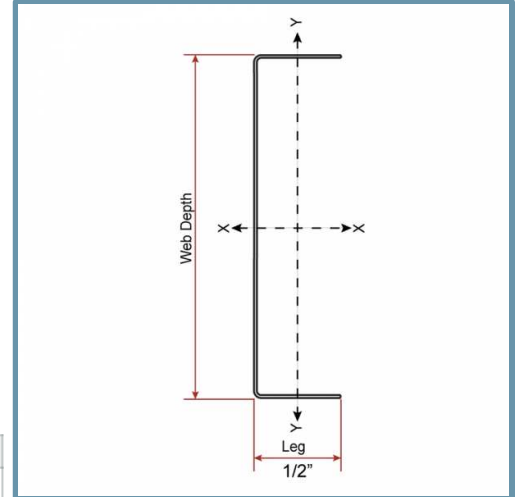
Ultimate, Fu: 45 ksi
Yield stress, Fy: 33ksi
 *Fy with Cold-Work, Fya 39.4 ksi

Gross Section Properties of Full Section, Strong Axis	
Cross sectional area (A)	0.158 in ²
Member weight per foot of length	0.537 lb/ft
Moment of inertia (Ix)	0.080 in ⁴
Radius of gyration (Rx)	0.711 in
Gross moment of inertia (Iy)	0.003 in ⁴
Gross radius of gyration (Ry)	0.137 in
Effective Section Properties, Strong Axis	
Moment of inertia for deflection (Ix)	0.080 in ⁴
Section modulus (Sx)	0.080 in ⁴
Section modulus (Sx)	0.080 in ³
Allowable bending moment (Ma)	1.883 in-k
Allowable shear force (Va)	1190 lb



Product Data & Ordering Information:

Coating: G40, CP60 or G90 **Color coding:** Green **Stock length:** 10'-0" long pieces (Custom length available by special orders) **Packaging:** 10 pieces per bundle - 240 pieces per pallet **Packaging weight:** 54 lbs/bundle

Code Approvals & Performance Standards

- **AISI S100-16 (2020) w/S2-20** North American Specification for the Design of Cold-Formed Steel Structural Members
- **AISI S240-20** North American Standard for Cold-Formed Steel Structural Framing
 - (Compliant to ASTM C955, but IBC replaced with AISI S200 in IBC 2015, AISI S240 in IBC 2018)
 - Section A3 Material - Chemical & mechanical requirements (Referencing ASTM A1003/A1003M)
 - Section A4 Corrosion Protection (Referencing ASTM A653/A653M)
 - Section C Installation - (Referencing ASTM C1007)
- **SDS For ASTM A1003 Steel Framing Products** For Interior Framing, Exterior Framing and Clips/Accessories

Sustainability Credits For more details and LEED letters contact Technical Services at 888-437-3244 or visit clarkdietrich.com/LEED.

- **LEED v4.1 MR Credit:** Environmental Product Declarations: EPD (1 point) - Sourcing of Raw Materials (up to 2 points) - Material Ingredients (1 point) - Construction and Demolition Waste Management (up to 2 points)
- **LEED v4 MR Credit:** Building Product Disclosure and Optimization: EPD (1 point) - Sourcing of Raw Materials (1 point) - Material Ingredients (1 point) - Construction and Demolition Waste Management (up to 2 points) - Innovation Credit (up to 2 points).

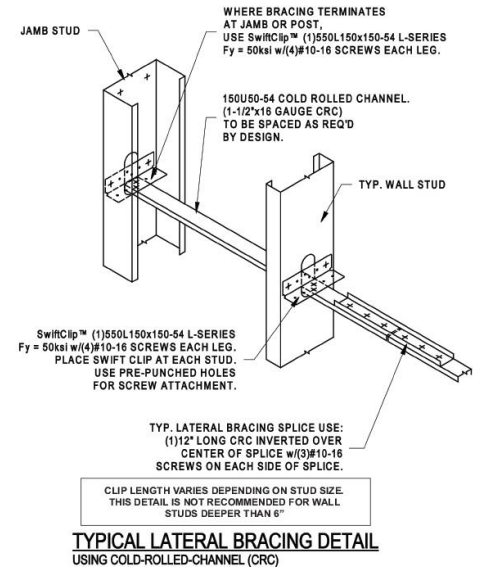

For more ClarkDietrich CAD details see:
cad.clarkdietrich.com