

ICC-ES Evaluation Report

ESR-4105

Reissued August 2024

Revised December 2024

Subject to renewal August 2025

This report also contains:

- [City of LA Supplement](#)

ICC-ES Evaluation Reports are not to be construed as representing aesthetics or any other attributes not specifically addressed, nor are they to be construed as an endorsement of the subject of the report or a recommendation for its use. There is no warranty by ICC Evaluation Service, LLC, express or implied, as to any finding or other matter in this report, or as to any product covered by the report.

Copyright © 2024 ICC Evaluation Service, LLC. All rights reserved.

<p>DIVISION: 04 00 00— MASONRY</p> <p>Section: 04 05 19.16— Masonry Anchors</p>	<p>REPORT HOLDER: DEWALT</p> 	<p>EVALUATION SUBJECT:</p> <p>AC100+ GOLD® ADHESIVE ANCHORING SYSTEM IN UNREINFORCED MASONRY (DEWALT)</p>	
---	--	---	---

1.0 EVALUATION SCOPE

Compliance with the following codes:

- 2024, 2021, 2018, 2015, 2012, 2009 and 2006 [International Building Code® \(IBC\)](#)
- 2024, 2021, 2018, 2015, 2012, 2009 and 2006 [International Residential Code® \(IRC\)](#)
- 2024, 2021, 2018, 2015, 2012, 2009 and 2006 [International Existing Building Code® \(IEBC\)](#)

Main references of this report are for the 2024 IBC, IRC and IEBC. See [Table 4](#) and [Table 5](#) for applicable sections of the code for previous editions.

Property evaluated:

- Structural

2.0 USES

Adhesive anchors installed using the AC100+ Gold Adhesive Anchoring System are post-installed adhesive anchors used for anchoring threaded steel rods or deformed steel reinforcement bars in unreinforced brick masonry. Adhesive anchors installed in unreinforced masonry with the AC100+ Gold adhesive anchoring system are designed to resist short-term loads imposed by earthquake or wind, as noted in Section 4.0 of this report.

The adhesive anchors are an alternative to anchors described in Section 8.1.4 of TMS 402, as referenced in Section 2107.1 of the IBC. The adhesive anchors are an alternative to bolts described in Section A107.4 and Section A113.1 of the IEBC. The anchoring system may also be used where an engineered design is submitted in accordance with Section R301.1.3 of the IRC.

3.0 DESCRIPTION

3.1 General:

The AC100+ Gold Adhesive Anchoring System is comprised of a two-component adhesive filled in cartridges, static mixing nozzles, dispensing tools, hole cleaning equipment, a steel anchor element, and steel mesh screen tubes.

Product names for the report holder is presented in the following table of this report.

Company Name	Adhesive Product Name
DEWALT	AC100+ Gold®
	AC100-PRO (outside North America)

The adhesive is used with continuously threaded steel rods and deformed reinforcing bars; the adhesive, screen tubes, and steel elements are installed in pre-drilled holes into masonry walls as described in this report.

3.2 Materials:

3.2.1 AC100+ Gold adhesive: The AC100+ Gold adhesive is a two-component adhesive that is packaged in dual-cylinder plastic cartridges to keep the adhesive components separate and allow for multiple uses. The components combine and react when dispensed with a manual or powered tool through a disposable injection mixing nozzle containing an internal mixing element supplied by DEWALT. The mixing nozzle may be replaced to permit multiple uses of the plastic cartridges. AC100+ Gold adhesive is available in 9.5-ounce (280 mL), 11.5-ounce (345 mL) and 28-ounce (825 mL) cartridges. Each cartridge label is marked with the adhesive expiration date. A shelf life, as indicated by the expiration date, applies to an unopened cartridge when stored in accordance with the manufacturer's recommendations.

3.2.2 Steel Anchor Rods and Reinforcing Bars: Threaded steel rods must be $\frac{3}{4}$ -inch (19.1 mm) diameter and must comply with ASTM A36, ASTM F1554, Grade 36 or ASTM A307. The $\frac{3}{4}$ -inch (19.1 mm) diameter threaded rods may also be used in a pre-bent $22\frac{1}{2}$ -degree configuration (threaded rods must not be bent after installation). Threaded rods must be supplied with hex nuts conforming to ASTM A563 Grade A. Material types of the nuts and washers must be matched to the threaded rods. Deformed steel reinforcing bars must be No. 4, No. 5 or No. 6 and must comply with ASTM A615, A706, A767 or A996, Grade 60.

3.2.3 Steel Screen Tubes: Steel mesh screen tubes are used in the unreinforced masonry with the adhesive and threaded steel anchor rods or deformed reinforcing bars. The screen tubes hold the adhesive in position in unreinforced masonry wall during the installation of the steel anchor elements.

3.3 Unreinforced Masonry:

The existing unreinforced masonry walls must have a minimum nominal thickness of 13 inches (330 mm) [3 wythes of brick]. The average in-place mortar shear strength of the building's unreinforced masonry determined in accordance with IEBC Section A106.2.3 must be no less than 40 psi (275 kPa) net.

4.0 DESIGN AND INSTALLATION

4.1 General:

Two types of anchor assemblies are available: these assemblies are described as Configuration A (shear anchor or rebar dowel) and Configuration B ($22\frac{1}{2}$ -degree combination anchor).

4.1.1 Configuration A, Threaded Rods or Steel Reinforcing Bars in Shear (Shear Anchor or Rebar Dowel): Configuration A is the anchor assembly resisting shear loads only, where the outside face of the wall is inaccessible. Configuration A consists of a $\frac{3}{4}$ -inch-diameter (19.1 mm) threaded rod or a No. 4, 5 or No. 6 reinforcing bar and a $\frac{15}{16}$ -inch-diameter-by-8-inch-long (23.8 mm by 203 mm) steel screen tube. [Figure 1](#) shows details of an anchor installed in Configuration A.

4.1.2 Configuration B, Threaded Rods in Tension and Shear ($22\frac{1}{2}$ -degree Combination Anchor): Configuration B is the anchor assembly resisting a combination of tension and shear loads where the outside face of the wall is not accessible. The anchor must be installed in the wall at an angle of $22\frac{1}{2}$ degrees in the vertical plane (upward or downward from the horizontal). Configuration B consists of a $\frac{3}{4}$ -inch-diameter (19.1 mm), prebent threaded rod used with a $\frac{15}{16}$ -inch-by-13-inch-long (23.8 mm by 330 mm) steel screen tube. The threaded rod must be embedded a minimum of 13 inches (330 mm) at the $22\frac{1}{2}$ -degree downward angle. [Figure 2](#) shows details of an installed Configuration B.

4.2 Design:

Adhesive anchors installed using the AC100+ Gold Adhesive Anchoring System are intended to resist only short-term loads imposed by wind or earthquake. The adhesive anchors must be approved by a registered design professional and installed under special inspection in accordance with Section 4.5 of this report. The edge distance and vertical and horizontal spacing for the anchor assemblies described in Section 4.1 must comply with [Table 2](#).

Conditions of acceptance for threaded rods and reinforcing bars in unreinforced brick masonry are as follows:

4.2.1 Configuration A, Threaded Rods or Steel Reinforcing Bars in Shear (Shear Anchor or Rebar Dowel):

- Installation of assemblies using threaded rods or reinforcing bars in Configuration A intended to resist shear loads only must comply with Sections 4.1.1 and 4.3, and [Figure 1](#) of this report.
- The allowable shear load for the $\frac{3}{4}$ -inch-diameter (19.1 mm) threaded rod is 1,000 pounds (4,450 N), as shown in [Table 3](#). For the No. 4, No. 5 and No. 6 reinforcing bars, the allowable shear loads are 500, 750 and 1,000 pounds (2,225, 3,338, and 4,450 N), respectively, as shown in [Table 3](#). No adjustment for wind or earthquake loading is permitted.

- c. The allowable shear loads noted above are applicable only to anchors installed in walls where in-place shear tests indicate a minimum mortar strength of 40 psi (275 kPa) net in accordance with IEBC Section A106.2.3.

4.2.2 Configuration B, Threaded Rods in Tension and Shear (22¹/₂-degree Combination Anchor):

- a. Installation of assemblies using threaded rods in Configuration B intended to resist a combination of tension and shear loads must comply with Sections 4.1.2 and 4.3, and [Figure 2](#) of this report.
- b. The maximum allowable tension load for the ³/₄-inch-diameter (19.1 mm) prebent threaded rod (Configuration B) is 1,200 pounds (5,340 N), as shown in [Table 3](#). No adjustment for wind or earthquake loading is permitted.
- c. The maximum allowable shear load for the ³/₄-inch-diameter (19.1 mm) prebent threaded rod is 460 pounds (2,045 N), as shown in [Table 3](#). No adjustment for wind or earthquake loading is permitted.
- d. For the ³/₄-inch-diameter (19.1 mm) prebent threaded rod subjected to combined tension and shear, the allowable combined load must be determined using the following equation:

$$(P_s/P_t) + (V_s/V_i) \leq 1$$

where:

- P_s = Applied service tension load.
 P_t = Allowable service tension load.
 V_s = Applied service shear load.
 V_i = Allowable service shear load.

- e. The allowable tension and shear values as determined above are applicable only to anchors installed in walls where in-place shear tests indicate minimum mortar strength of 40 psi (275 kPa) net in accordance with IEBC Section A106.2.3.

4.3 Installation:

4.3.1 General: Adhesive anchors must be installed in accordance with this report and the manufacturer's published installation instructions (MPII) as represented in [Figure 3](#). The drill bit size, hole diameter, embedment depth, spacing, edge distance and base material must comply with the requirements of this report. Gel and curing times for the AC100+ Gold adhesive and the respective masonry temperature during installation and cure are shown in [Table 1](#). The adhesive anchors must be installed under special inspection in accordance with Section 4.5 of this report.

4.3.2 Configuration A, Threaded Rods or Steel Reinforcing Bars in Shear (Shear Anchor or Rebar Dowel): For Configuration A, vertical and horizontal anchor spacing and edge distances must comply with [Table 2](#) of this report. 1-inch-diameter (25.4 mm) holes must be drilled using standard carbide-tipped masonry drill bits complying with ANSI Specification B212.15-1994. The holes must be drilled 8 inches (203 mm) deep and perpendicular to the wall. A rotary drill, or a rotary hammer drill set on "rotation only," must be used to drill the holes. [Figure 1](#) illustrates an anchor installed in Condition A. [Figure 3](#) illustrates the MPII including drilling, hole cleaning, adhesive injection with screen tubes, anchor insertion, curing and attachment.

4.3.3 Configuration B, Threaded Rods in Tension and Shear (22¹/₂-degree Combination Anchor): For Configuration B, anchor spacing and edge distances must comply with [Table 2](#) of this report. 1-inch-diameter (25.4 mm) holes must be drilled using standard carbide-tipped masonry drill bits complying with ANSI Specification B212.15-1994. Holes must be at a 22¹/₂-degree downward angle (measured from horizontal) to within one inch (25.4 mm) of the opposite wall surface, to a minimum depth of 13 inches (330 mm). A rotary drill, or a rotary hammer drill set on "rotation only," must be used to drill the holes. [Figure 2](#) illustrates an anchor installed in Condition B. [Figure 3](#) illustrates the MPII including drilling, hole cleaning, adhesive injection with screen tubes, anchor insertion, curing and attachment.

4.4 Field Tests:

- a. Tests for in-place mortar shear strength of the building must be conducted in accordance with Section A106.2.3 of the IEBC. In-place mortar shear strengths shall indicate a minimum mortar strength of 40 psi (275 kPa).
- b. Adhesive anchors resisting tension forces or a combination of tension and shear forces must be tested in accordance with Section A107.4 of the IEBC. The test report must include:
1. Test location(s)
 2. Brick/mortar condition
 3. Bolt movement/elongation
 4. Embedment depth and masonry wall thickness
 5. Applied load, loading procedure, load increments, and rate of loading.

4.5 Special Inspection:

4.5.1 IBC and IRC: Continuous special inspection must be conducted in accordance with Sections 1704 and 1705 of the IBC.

4.5.2 IEBC: Periodic inspection, direct-tension tests, and calibrated torque wrench tests must be conducted in accordance with Section A107.4 of the IEBC. In lieu of testing and periodic inspection, the IEBC permits continuous special inspection during installation of anchors resisting shear forces only.

5.0 CONDITIONS OF USE:

Adhesive anchors installed using the AC100+ Gold Adhesive Anchoring System in Unreinforced Masonry described in this report comply with, or are a suitable alternative to what is specified in, those codes listed in Section 1.0 of this report, subject to the following conditions:

- 5.1 Use and installation must be as set forth in this evaluation report and the manufacturer's printed installation instructions (MPII) illustrated in [Figure 3](#) of this report. In case of conflict, this report governs.
- 5.2 Calculations and details must be submitted to the code official for approval.
- 5.3 Special inspection must be in accordance with Section 4.5 of this evaluation report.
- 5.4 Use of the anchor system must be approved by the registered design professional.
- 5.5 The existing mortar shall have a minimum in-place shear strength of 40 psi (275kPa) in accordance with Section 3.3 of this report prior to installation of the adhesive anchors.
- 5.6 Adhesive anchors must be limited to resisting transient or short-term (wind or seismic) loads only.
- 5.7 Anchors are installed in holes predrilled with a carbide-tipped masonry drill bit complying with ANSI B212.15-1994. Holes must be drilled using a rotary drill, or a rotary hammer drill set on "rotation only" (non-impact). Impact tools must not be used for drilling holes or for tightening steel anchors or nuts.
- 5.8 The AC100+ Gold Adhesive Anchoring System is manufactured under a quality-control program with inspections by ICC-ES.

6.0 EVIDENCE SUBMITTED

Data in accordance with the [ICC-ES Acceptance Criteria for Anchors in Unreinforced Masonry Elements \(AC60\)](#), dated December 2009 (editorially revised November 2024); and quality-control documentation.

7.0 IDENTIFICATION

- 7.1 AC100+ Gold adhesive cartridges are identified by labels on the cartridge or packaging bearing the company name (DEWALT), product name, the batch number, the expiration date, and the evaluation report number (ESR-4105). The screen tubes are identified by packaging label displaying the company name and product name. Threaded rods, nuts, washers, and deformed reinforcing bars are standard elements and must conform to applicable national or international specifications.
- 7.2 The report holder's contact information is the following:

DEWALT
701 EAST JOPPA ROAD
TOWSON, MARYLAND 21286
(800) 524-3244
www.DEWALT.com
anchors@DEWALT.com

The DEWALT drilling systems shown below collect and remove dust with a HEPA dust extractor during the hole drilling operation in dry base materials using hammer-drills set to “rotation only” (non-impact). See step 1 of the manufacturer’s printed installation instructions.













DeWALT Dust Removal Drilling Systems with HEPA Dust Extractor Options			
Tool	Accessories and Shrouds	HEPA Dust Extractor	
SDS-Max Drills			
 Cordless  Corded	 SDS-Max Hollow Drill Bit	 Dust Extractor	
	 SDS-Max With Shroud		
SDS-Plus Drills			
 Cordless	 SDS-Plus Bit		 Cordless Dust Extractor
	 Corded	 SDS-Plus Hollow Drill Bit	 Dust Extractor
 SDS-Plus With Telescope			
	 SDS-Plus With Shroud		

FIGURE A—EXAMPLES OF DEWALT DUST REMOVAL DRILLING SYSTEMS WITH HEPA DUST EXTRACTORS FOR ILLUSTRATION

TABLE 1—GEL AND CURING TIMES FOR AC100+ GOLD ADHESIVE¹

Temperature of base material		Approximate gel (working) time	Full curing time
14°F	-10°C	90 minutes	24 hours
23°F	-5°C	90 minutes	14 hours
32°F	0°C	45 minutes	7 hours
41°F	5°C	25 minutes	2 hours
68°F	20°C	6 minutes	45 minutes
86°F	30°C	4 minutes	25 minutes
104°F	40°C	1.5 minutes	15 minutes

¹Linear interpolation to determine approximate gel and full curing times for intermediate base material temperatures is allowed. For installations in masonry temperatures between 14°F and 23°F the cartridge temperature must be conditioned to between 68°F and 95°F (20°C - 35°C).

TABLE 2—SPACING AND EDGE DISTANCE REQUIREMENTS FOR AC100+ GOLD ADHESIVE INSTALLED IN UNREINFORCED MASONRY

ANCHOR ASSEMBLY	Minimum Vertical Spacing (inches)	Minimum Horizontal Spacing (inches)	Minimum Edge Distance (inches)
Shear anchor or rebar dowel, Configuration A (see Figure 1)	16	16	16
22 ¹ / ₂ ° combination anchor, Configuration B (see Figure 2)	16	16	16

For SI: 1 inch = 25.4 mm

TABLE 3—ALLOWABLE LOAD CAPACITIES FOR THREADED RODS AND REINFORCING BARS FOR AC100+ GOLD ADHESIVE INSTALLED IN UNREINFORCED MASONRY^{1,2}

SHEAR ANCHOR OR REBAR DOWEL – CONFIGURATION A (FIGURE 1)				
Anchor Rod Dia. (inch) or Rebar Size	Minimum Embedment (inches)	Minimum Wall Thickness (inches)	Allowable Tension Load (pounds)	Allowable Shear Load ³ (pounds)
3/4	8	13	-	1,000
No. 4	8	13	-	500
No. 5	8	13	-	750
No. 6	8	13	-	1,000
22 ¹ / ₂ ° COMBINATION ANCHOR – CONFIGURATION B (FIGURE 2)				
Anchor Rod Dia. (inch)	Minimum Embedment	Minimum Wall Thickness (inches)	Allowable Tension Load ³ (pounds)	Allowable Shear Load ³ (pounds)
3/4	Within 1 inch of opposite wall surface	13	1,200	1000

For SI: 1 inch = 25.4 mm, 1 lbf = 4.45 N, 1 foot-pound = 1.356 N-m, 1 psi = 6.89 Pa.

¹Allowable load values are applicable only to anchors where in-place shear tests indicate minimum mortar strength of 40 psi (275 kPa), net.

²No increase for lateral loading is permitted, such as loading induced by wind or earthquake.

³anchors must be tested in accordance with Section 4.4 for use with the IEBC.

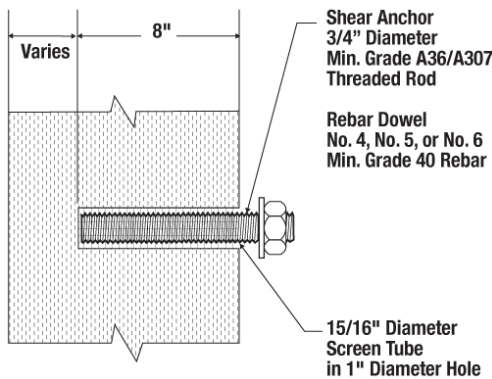

FIGURE 1—CONFIGURATION A (SHEAR ANCHOR OR REBAR DOWEL)¹

¹Screen tubes are nominally 8 inches long in accordance with Section 4.1.1 of this report.

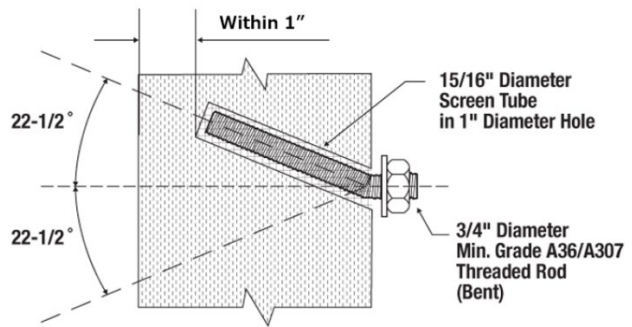

FIGURE 2—CONFIGURATION B (22¹/₂-DEGREE COMBINATION ANCHOR)¹

¹Screen tubes are nominally 13 inches long in accordance with Section 4.2.1 of this report.

TABLE 4— APPLICABLE SECTIONS OF THE IBC, IRC, and IEBC UNDER EACH EDITION OF THE CODE

IBC						
2024 IBC	2021 IBC	2018 IBC	2015 IBC	2012 IBC	2009 IBC	2006 IBC
			Section 1704			
			Section 1705			
			Chapter 21			
			Section 2107.1			
IRC						
2024 IRC	2021 IRC	2018 IRC	2015 IRC	2012 IRC	2009 IRC	2006 IRC
			Section R301.1.3			
IEBC						
2024 IEBC	2021 IEBC	2018 IEBC	2015 IEBC	2012 IEBC	2009 IEBC	2006 IEBC
	A106.2.3			A106.3.3		
			A107.4			
			A113.1			

TABLE 5— APPLICABLE SECTIONS OF TMS 402 UNDER EACH EDITION OF THE IBC

2024 IBC	2021 IBC	2018 IBC	2015 IBC	2012 IBC	2009 IBC	2006 IBC
TMS 402-22	TMS 402-16		TMS 402-13	TMS 402-11	TMS 402-08	TMS 402-05
Section 8.1.4	Section 8.1.3			Section 2.1.4		

INSTALLATION INSTRUCTIONS (HOLLOW BASE MATERIALS AND UNREINFORCED MASONRY [URM])

DRILLING

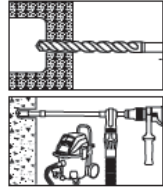

- 1- Drill a hole into the base material with a rotary drill tool to the size and embedment required by the selected screen tube size and steel anchor element (see installation specifications for threaded rod in hollow base material with screen tube supplied by DeWALT). The tolerances of the drill bit, including hollow drill bits, must meet the requirements of ANSI B212.15.
- Precaution: Wear suitable eye and skin protection. Avoid inhalation of dust during drilling and/or removal (see dust extraction by DeWALT to minimize dust emission).
- Drilling in dry base materials is recommended when using hollow drill bits (vacuum must be on).

HOLE CLEANING (BLOW 2X, BRUSH 2X, BLOW 2X)

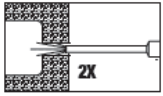

- 2- Starting from the bottom or back of the anchor hole, blow the hole clean with a hand pump (min. volume 25 fl.oz. supplied by DeWALT) or compressed air nozzle a minimum of two times (2x).

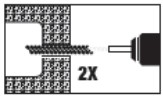

- Determine the wire brush diameter (see installation specifications) and attach the brush with adaptor to a rotary drill tool or battery screw gun. Brush the hole with the selected wire brush a minimum of two times (2x). A brush extension (supplied by DeWALT, Cat #08282) should be used for holes drilled deeper than the listed brush length.
- The wire brush should be checked periodically during use. The brush must be replaced if it becomes worn and does not come in contact with sides of the drill hole.
- Finally, blow the hole clean again a minimum of two times (2x)
- When finished the hole should be clean and free of dust, debris, ice, grease, oil or other foreign material.

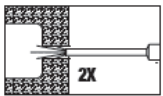

PREPARING



- 3- Check adhesive expiration date on cartridge label. Do not use expired product. Review Safety Data Sheet (SDS) before use. Cartridge temperature must be between 23°F - 95°F (-5°C - 35°C) when in use unless otherwise noted. Review gel (working) time and curing time table. Consideration should be given to the reduced gel (working) time of the adhesive in warm temperatures.

- Attach a supplied mixing nozzle to the cartridge. Do not modify the mixer in any way and make sure the mixing element is inside the nozzle. Load the cartridge into the correct dispensing tool.
- Note: Always use a new mixing nozzle with new cartridges of adhesive and also for all work interruptions exceeding the published working time of the adhesive.

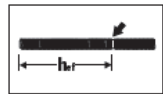

- 4- Prior to inserting the anchor into the filled screen tube, the position of the embedment depth has to be marked on the anchor. Verify anchor element is straight and free of surface damage.

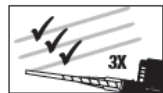

- 5- Adhesive must be properly mixed to achieve published properties. Prior to dispensing adhesive into the drilled hole, separately dispense at least three full strokes of adhesive through the mixing nozzle until the adhesive is a consistent GRAY color. Do not attach a used nozzle when changing to a new cartridge.
- Review and note the published working and cure times (see gel time and curing time table) prior to injection of the mixed adhesive into the screen tube.

INSTALLATION

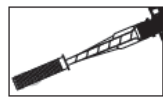

- 6- Select a screen tube of suitable length (supplied by DeWALT). Fill the screen tube full with adhesive starting from the bottom or back of the tube. Slowly withdraw the mixing nozzle as the screen fills to avoid creating air pockets or voids. A plastic extension tube supplied by DeWALT must be used with the mixing nozzle if the back of the screen tube cannot be reached.



- 7- Insert the screen tube filled with adhesive into the cleaned anchor hole. Inject additional adhesive into the screen tube as necessary to ensure the screen tube is completely filled.
- Note: Overfilling the screen tube is acceptable but not required.



- 8- Prior to inserting the anchor rod into the screen tube inspect it to ensure that it is free of dirt, grease, oil or other foreign material.
- Push the threaded rod into the screen tube while turning slightly to ensure positive distribution of the adhesive until back of the tube is reached.
 - Note: In cases where the drilled hole size is larger than specified due to rotary drilling (e.g. an elongated opening), the annular space between the screen tube and the hole at the base material surface must be filled with adhesive.

CURING AND FIXTURE

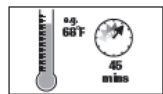

- 9- Allow the adhesive anchor to cure to the specified full curing time prior to applying any load.
- Do not disturb, torque or load the anchor until it is fully cured (see gel time and curing time table).

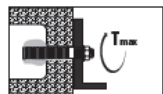

- 10- After full curing of the adhesive anchor, a fixture can be installed to the anchor and tightened up to the maximum torque (see installation specifications for threaded rod in hollow base material) by using a calibrated torque wrench.
- Take care not to exceed the maximum torque for the selected anchor.

FIGURE 3—AC100+ GOLD ADHESIVE ANCHORS INSTALLED INTO UNREINFORCED MASONRY AND HOLLOW BASE MATERIALS, MANUFACTURER'S PRINTED INSTALLATION INSTRUCTIONS (MPII)

DIVISION: 04 00 00—MASONRY
Section: 04 05 19.16—Masonry Anchors

REPORT HOLDER:

DEWALT

EVALUATION SUBJECT:

AC100+ GOLD® ADHESIVE ANCHORING SYSTEM IN UNREINFORCED MASONRY (DEWALT)

1.0 REPORT PURPOSE AND SCOPE

Purpose:

The purpose of this evaluation report supplement is to indicate that adhesive anchors installed using the AC100+ Gold Adhesive Anchoring System in unreinforced masonry, described in ICC-ES evaluation report [ESR-4105](#), have also been evaluated for compliance with the codes noted below as adopted by the Los Angeles Department of Building and Safety (LADBS).

Applicable code editions:

- 2023 *City of Los Angeles Building Code* ([LABC](#))
- 2023 *City of Los Angeles Residential Code* ([LARC](#))
- 2023 *City of Los Angeles Existing Building Code* ([LAEBC](#))

2.0 CONCLUSIONS

Adhesive anchors installed using the AC100+ Gold Adhesive Anchoring System in unreinforced masonry, described in Sections 2.0 through 7.0 of the evaluation report [ESR-4105](#), comply with the LABC Chapters 21 and 88, LAEBC Appendix A Chapter A1, and the LARC, and are subjected to the conditions of use described in this supplement.

3.0 CONDITIONS OF USE

Adhesive anchors installed using the AC100+ Gold Adhesive Anchoring System in unreinforced masonry described in this evaluation report supplement must comply with all of the following conditions:

- All applicable sections in the evaluation report [ESR-4105](#).
- The design, installation, conditions of use and identification of the anchors are in accordance with the 2021 *International Building Code*® (IBC) and the 2021 *International Existing Building Code*® (IEBC) provisions noted in the evaluation report [ESR-4105](#).
- The design, installation, testing and inspection are in accordance with additional requirements of LABC Chapters 16, 17, 21, 88 and LAEBC Appendix A Chapter A1, as applicable, including LABC Sections 1704, 1705, and 2107, and LAEBC Sections A106, A107 and A108.
- Under the LARC, an engineered design in accordance with LARC Section R301.1.3 and additional requirements noted in this supplement must be submitted.
- The allowable strength values listed in the evaluation report and tables are for the connection of the anchors to the masonry. The connection between the anchors and the connected members must also be checked for capacity (which may govern).

This supplement expires concurrently with the evaluation report, reissued August 2024 and revised December 2024.