

GENERAL INFORMATION**AC50™**

Adhesive Anchoring System

PRODUCT DESCRIPTION

The AC50 is a two-component, adhesive anchoring system. The system includes injection adhesive in plastic cartridges, mixing nozzles, dispensing tools and hole cleaning equipment. AC50 is designed for bonding threaded rod and reinforcing bar hardware into drilled holes in solid concrete base materials.

GENERAL APPLICATIONS AND USES

- Bonding threaded rod and reinforcing bar into hardened concrete
- Evaluated for installation and use in dry holes in concrete
- Can be installed in a range of base material temperatures including as low as 5°F (-15°C)

FEATURES AND BENEFITS

- + Designed for use with threaded rod and reinforcing bar hardware elements
- + Cartridge design allows for multiple uses using extra mixing nozzles
- + Mixing nozzles proportion adhesive and provide simple delivery method into drilled holes
- + Evaluated and recognized for long term and short term loading

APPROVALS AND LISTINGS

- Conforms to requirements of ASTM C881 including C882 and AASHTO M235, Types I, II, IV and V, Grade 3, Classes A & B (also meets Type III except for elongation)
- Tested in accordance with ASTM E488
- Department of Transportation listings – see www.DEWALT.com or contact transportation agency

GUIDE SPECIFICATIONS

CSI Divisions: 03 16 00 - Concrete Anchors and 05 05 19 - Post-Installed Concrete Anchors. Adhesive anchoring system shall be AC50 as supplied by DEWALT, Towson, MD. Anchors shall be installed in accordance with published instructions and requirements of the Authority Having Jurisdiction.

SECTION CONTENTS

General Information.....	1
Installation Specifications	2
Performance Data (ASD)	3
Installation Instructions (Solid Base Materials)	5
Reference Installation Tables	6
Ordering Information	7



AC50 ADHESIVE IN CARTRIDGE
(STANDARD THREADED ROD AND
REBAR STEEL SUPPLIED BY OTHERS)

PACKAGING (10:1 MIX RATIO)**Coaxial Cartridge**

- 14 fl. oz. (420 mL or 25.5 in³)

Dual Cartridge (side-by-side)

- 28 fl. oz. (825 mL or 50 in³)

STORAGE LIFE & CONDITIONS

Fifteen months in a dry, dark environment with temperature ranging from 32°F to 86°F (0°C to 30°C)

ANCHOR SIZE RANGE (TYPICAL)

- 3/8" to 1" diameter threaded rod
- No. 3 to No. 8 rebar

SUITABLE BASE MATERIALS

- Normal-weight concrete

INSTALLATION SPECIFICATIONS

Installation Specifications for Threaded Rod and Reinforcing Bar

Dimension/Property	Notation	Units	Nominal Anchor Size					
			3/8	1/2	5/8	3/4	1	
Threaded Rod	-	in.	3/8	1/2	5/8	3/4	1	
Reinforcing Bar	-	No.	#3	#4	#5	#6	#8	
Nominal anchor diameter	d_a (d)	in. (mm)	0.375 (9.5)	0.500 (12.7)	0.625 (15.9)	0.750 (19.1)	0.875 (22.2)	
Nominal drill bit size (ANSI)	d_o (d _{bit})	in.	7/16	9/16	11/16 or 3/4	7/8	1-1/8	
Minimum embedment	h_{nom}	in. (mm)	2-3/8 (60)	2-3/4 (70)	3-1/8 (79)	3-1/2 (89)	4 (102)	
Minimum concrete member thickness	h_{min}	in. (mm)	$h_{nom} + 1-1/4$ ($h_{nom} + 30$)		$h_{nom} + 2d_o$			
Minimum spacing distance	s_{min}	in. (mm)	1-7/8 (48)	2-1/2 (64)	3-1/8 (79)	3-3/4 (95)	5 (127)	
Minimum edge distance (up to 100% T_{max})	c_{min}	in. (mm)	1-7/8 (48)	2-1/2 (64)	3-1/8 (79)	3-3/4 (95)	5 (127)	
Maximum torque (only possible after full cure time of adhesive)	ASTM A36 or F1554 Grade 36	T_{max}	ft.- lbs. (N-m)	10 (13)	25 (34)	50 (68)	90 (122)	165 (224)
	ASTM F593 Condition CW stainless steel rod or ASTM A193 Grade B7 carbon steel rod	T_{max}	ft.- lbs. (N-m)	15 (20)	33 (45)	60 (81)	105 (142)	165 (224)

Detail of Steel Hardware Elements used with Injection Adhesive System

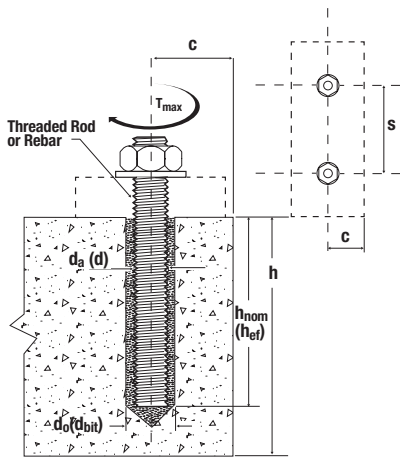

Nomenclature

- d_a (d) = Diameter of anchor
- d_o (d_{bit}) = Diameter of drilled hole
- h = Base material thickness
- h_{nom} (h_{ef}) = Embedment depth
- s = Spacing of anchors
- c = Edge distance
- T_{max} = Maximum torque

Threaded Rod and Deformed Reinforcing Bar Material Properties

Steel Description (General)	Steel Specification (ASTM)	Nominal Anchor Size (inch/No.)	Minimum Yield Strength, f_y (psi)	Minimum Ultimate Strength, f_u (psi)
Carbon rod	A36 or F1554 Grade 36	3/8 through 1	36,000	58,000
	F1554 Grade 55		55,000	75,000
	A449	3/8 through 1	92,000	120,000
	A193, Grade B7 or F1554 Grade 105	3/8 through 1	105,000	125,000
	F568M Class 5.8	3/4 through 1	58,000	72,500
Stainless rod	F593 Condition CW	3/8 through 5/8	65,000	100,000
		3/4 through 1	45,000	85,000
	A193/A193M Grade B8/B8M, Class 1	3/8 through 1	30,000	75,000
	A193/A193M Grade B8/B8M2, Class 2B	3/8 through 1	75,000	95,000
Reinforcing Bar	A615, A767, Grade 40	#3 through #6	40,000	60,000
	A615, A767, Grade 60	#3 through #8	60,000	90,000
	A706, A767, Grade 60		60,000	80,000
	A615, A767, Grade 75	#3 through #8	75,000	100,000
	A706, A767, Grade 80	#3 through #8	80,000	100,000

Tabulated material properties are provided for reference; other steel hardware elements may also be considered.



PERFORMANCE DATA (ASD)

Ultimate and Allowable Tension Load Capacities for AC50 Installed with Threaded Rod into Normal Weight Concrete (based on bond strength/concrete capacity)^{1,2,3,4,5,6}

Nominal Anchor Diameter d in.	Minimum Embedment Depth h _{nom} in. (mm)	Minimum Concrete Compressive Strength, f' _c					
		2,500 psi (17.2 MPa)		3,000 psi (20.7 MPa)		4,000 psi (27.6 MPa)	
		Ultimate Tension Load Capacity lbs. (kN)	Allowable Tension Load Capacity lbs. (kN)	Ultimate Tension Load Capacity lbs. (kN)	Allowable Tension Load Capacity lbs. (kN)	Ultimate Tension Load Capacity lbs. (kN)	Allowable Tension Load Capacity lbs. (kN)
3/8	3-3/8 (86)	6,520 (29.0)	1,630 (7.3)	6,765 (30.1)	1,690 (7.5)	7,165 (31.9)	1,790 (8.0)
1/2	4-1/2 (114)	11,860 (52.8)	2,965 (13.2)	12,300 (54.7)	3,075 (13.7)	13,025 (57.9)	3,255 (14.5)
5/8	5-5/8 (143)	18,520 (82.4)	4,630 (20.6)	19,205 (85.4)	4,800 (21.4)	20,345 (90.5)	5,085 (22.6)
3/4	6-3/4 (172)	22,420 (99.7)	5,605 (24.9)	23,255 (103.4)	5,815 (25.9)	24,630 (109.6)	6,160 (27.4)
1	9 (229)	29,005 (129.0)	7,250 (32.2)	30,080 (133.8)	7,520 (33.5)	31,860 (141.7)	7,965 (35.4)

1. Allowable load capacities listed are calculated using an applied safety factor of 4.0. Consideration of safety factors of 10 or higher may be necessary depending on the application, such as life safety.
2. Linear interpolation may be used to determine allowable loads for intermediate and compressive strengths.
3. The tabulated load values are applicable to single anchors installed at critical edge and spacing distances of 3 times the embedment depth and where the minimum member thickness is the greater of [h_{nom} + 1-1/4"] and [h_{nom} + 2d_{bar}].
4. The tabulated load values are applicable for dry uncracked concrete installed into holes drilled with a hammer drill and an ANSI carbide drill bit.
5. Adhesives experience reductions in capacity at elevated temperatures. See the in-service temperature chart for allowable load capacity reduction factors.
6. Allowable bond strength/concrete capacity must be checked against allowable steel strength in tension to determine the controlling allowable load. Allowable shear capacity is controlled by allowable steel strength for the given conditions.

Ultimate and Allowable Tension Load Capacities for AC50 Installed with Reinforcing Bar into Normal Weight Concrete (based on bond strength/concrete capacity)^{1,2,3,4,5,6}

Nominal Anchor Diameter d in.	Minimum Embedment Depth h _{nom} in. (mm)	Minimum Concrete Compressive Strength, f' _c					
		2,500 psi (17.2 MPa)		3,000 psi (20.7 MPa)		4,000 psi (27.6 MPa)	
		Ultimate Tension Load Capacity lbs. (kN)	Allowable Tension Load Capacity lbs. (kN)	Ultimate Tension Load Capacity lbs. (kN)	Allowable Tension Load Capacity lbs. (kN)	Ultimate Tension Load Capacity lbs. (kN)	Allowable Tension Load Capacity lbs. (kN)
#3	3-3/8 (86)	6,225 (27.7)	1,555 (6.9)	6,460 (28.7)	1,615 (7.2)	6,840 (30.4)	1,710 (7.6)
#4	4-1/2 (114)	10,480 (46.6)	2,620 (11.7)	10,870 (48.4)	2,720 (12.1)	11,515 (51.2)	2,880 (12.8)
#5	5-5/8 (143)	16,830 (74.9)	4,210 (18.7)	17,455 (77.6)	4,365 (19.4)	18,490 (82.2)	4,625 (20.6)
#6	6-3/4 (172)	15,545 (69.1)	3,885 (17.3)	16,120 (71.7)	4,030 (17.9)	17,075 (76.0)	4,270 (19.0)
#6	9 (229)	16,015 (71.2)	4,005 (17.8)	16,610 (73.9)	4,155 (18.5)	17,590 (78.2)	4,400 (19.6)
#8	9 (229)	34,095 (151.7)	8,525 (37.9)	35,360 (157.3)	8,840 (39.3)	37,455 (166.6)	9,365 (41.7)
#8	12 (305)	39,060 (173.7)	9,765 (43.4)	40,510 (180.2)	10,130 (45.1)	42,910 (190.9)	10,730 (47.7)

1. Allowable load capacities listed are calculated using an applied safety factor of 4.0. Consideration of safety factors of 10 or higher may be necessary depending on the application, such as life safety.
2. Linear interpolation may be used to determine allowable loads for intermediate compressive strengths.
3. The tabulated load values are applicable to single anchors installed at critical edge and spacing distances of 3 times the embedment depth and where the minimum member thickness is the greater of [h_{nom} + 1-1/4"] and [h_{nom} + 2d_{bar}].
4. The tabulated load values are applicable for dry uncracked concrete installed into holes drilled with a hammer drill and an ANSI carbide drill bit.
5. Adhesives experience reductions in capacity at elevated temperatures. See the in-service temperature chart for allowable load capacity reduction factors.
6. Allowable bond strength/concrete capacity must be checked against allowable steel strength in tension to determine the controlling allowable load. Allowable shear capacity is controlled by allowable steel strength for the given conditions.

ADHESIVES
AC50™
Adhesive Anchoring System



Allowable Load Capacities for Threaded Rod and Reinforcing Bar (Based on Steel Strength)^{1,2,3,4}

Nominal Rod Diameter or Rebar Size (in. or No.)	Steel Elements - Threaded Rod and Reinforcing Bar																	
	A36 or F1554, Grade 36		A36 or F1554, Grade 55		A 193, Grade B7 or F1554, Grade 105		F 593, CW (SS)		ASTM A615 Grade 40 Rebar		ASTM A615 Grade 60 Rebar		ASTM A706 Grade 60 Rebar		ASTM A615 Grade 75 Rebar		ASTM A706 Grade 80 Rebar	
	Tension lbs. (kN)	Shear lbs (kN)	Tension lbs. (kN)	Shear lbs (kN)	Tension lbs. (kN)	Shear lbs (kN)	Tension lbs. (kN)	Shear lbs (kN)	Tension lbs. (kN)	Shear lbs (kN)	Tension lbs. (kN)	Shear lbs (kN)	Tension lbs. (kN)	Shear lbs (kN)	Tension lbs. (kN)	Shear lbs (kN)	Tension lbs. (kN)	Shear lbs (kN)
3/8 or #3	2,115 (9.4)	1,090 (4.8)	2,735 (12.2)	1,410 (6.3)	4,555 (20.3)	2,345 (10.4)	3,645 (16.2)	1,880 (8.4)	2,210 (9.8)	1,125 (5.0)	2,650 (11.8)	1,690 (7.5)	2,650 (11.8)	1,500 (6.7)	2,650 (11.8)	1,875 (8.3)	2,650 (11.8)	1,875 (8.3)
1/2 or #4	3,760 (16.7)	1,935 (8.6)	4,860 (21.6)	2,505 (11.1)	8,100 (36.0)	4,170 (18.5)	6,480 (28.8)	3,340 (14.9)	3,925 (17.5)	2,005 (8.9)	4,710 (21.0)	3,005 (13.4)	4,710 (21.0)	2,670 (11.9)	4,710 (21.0)	3,335 (14.8)	4,710 (21.0)	3,335 (14.8)
5/8 or #5	5,870 (26.1)	3,025 (13.5)	7,595 (33.8)	3,910 (17.4)	12,655 (56.3)	6,520 (29.0)	10,125 (45.0)	5,215 (23.2)	6,135 (27.3)	3,130 (13.9)	7,365 (32.8)	4,695 (20.9)	7,365 (32.8)	4,170 (18.5)	7,365 (32.8)	5,215 (23.2)	7,365 (32.8)	5,215 (23.2)
3/4 or #6	8,455 (37.6)	4,355 (19.4)	10,935 (48.6)	5,635 (25.1)	18,225 (81.1)	9,390 (41.8)	12,390 (55.1)	6,385 (28.4)	8,835 (39.3)	4,505 (20.0)	10,605 (47.2)	6,760 (30.1)	10,605 (47.2)	6,010 (26.7)	10,605 (47.2)	7,510 (33.4)	10,605 (47.2)	7,510 (33.4)
7/8 or #7	11,510 (51.2)	5,930 (26.4)	14,885 (66.2)	7,665 (34.1)	24,805 (110.3)	12,780 (56.8)	16,865 (75.0)	8,690 (38.7)	-	-	14,430 (64.2)	9,200 (40.9)	14,430 (64.2)	8,180 (36.4)	14,430 (64.2)	10,220 (45.5)	14,430 (64.2)	10,220 (45.5)
1 or #8	15,035 (66.9)	7,745 (34.5)	19,440 (86.5)	10,015 (44.5)	32,400 (144.1)	16,690 (74.2)	22,030 (98.0)	11,350 (50.5)	-	-	18,850 (83.8)	12,015 (53.4)	18,850 (83.8)	10,680 (47.5)	18,850 (83.8)	13,350 (59.4)	18,850 (83.8)	13,350 (59.4)
#9	-	-	-	-	-	-	-	-	-	-	23,985 (106.7)	15,290 (68.0)	23,985 (106.7)	13,590 (60.5)	23,985 (106.7)	16,990 (75.6)	23,985 (106.7)	16,990 (75.6)
1-1/4	23,490 (104.5)	12,100 (53.8)	30,375 (135.1)	15,645 (69.6)	50,620 (225.2)	26,080 (116.0)	34,425 (153.1)	17,735 (78.9)	-	-	-	-	-	-	-	-	-	-
#10	-	-	-	-	-	-	-	-	-	-	30,405 (135.2)	19,380 (86.2)	30,405 (135.2)	17,230 (76.6)	30,405 (135.2)	21,535 (95.8)	30,405 (135.2)	21,535 (95.8)

1. AISC defined steel strength (ASD) for threaded rod: Tensile = 0.33 • Fu • Anom, Shear = 0.17 • Fu • Anom
2. For reinforcing bars: The allowable steel tensile strength is based on 20 ksi for Grade 40 and 24 ksi for Grade 60 and higher, applied to the cross sectional area of the bar; allowable steel shear strength = 0.17 • Fu • Anom
3. Allowable load capacities are calculated for the steel element type. Consideration of applying additional safety factors may be necessary depending on the application, such as life safety or overhead.
4. Allowable steel strength in tension must be checked against allowable bond strength/concrete capacity in tension to determine the controlling allowable load.

In-Service Temperature Chart For Allowable Load Capacities

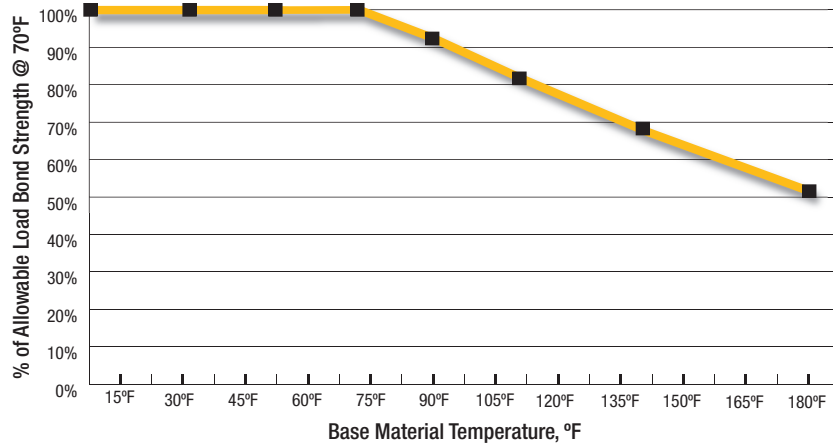

INSTALLATION INSTRUCTIONS (SOLID BASE MATERIALS)

DRILLING

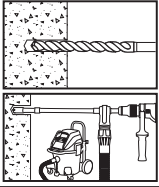

1- Drill a hole into the base material with rotary hammer drill (i.e. percussion drill) and a carbide drill bit to the size and embedment required by the selected steel hardware element (reference installation specifications for threaded rod and reinforcing bar). The tolerances of the carbide drill bits, including hollow bits, must meet ANSI Standard B212.15.

- Precaution: Use suitable eye and skin protection. Avoid inhalation of dust during drilling and/or removal.
- **Note!** In case of standing water in the drilled hole (flooded hole condition), all the water has to be removed from the hole (e.g. vacuum, compressed air, etc.) prior to cleaning.

Drilling in dry base materials is recommended when using hollow drill bits (vacuum must be on).

HOLE CLEANING (BLOW 4X, BRUSH 4X, BLOW 4X)

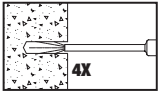

2a- Starting from the bottom or back of the anchor hole, blow the hole clean using a compressed air nozzle (min. 90 psi) a minimum of four times (4x).

- Use a compressed air nozzle (min. 90 psi) for anchor rod 3/8" to 1" diameter or reinforcing bar (rebar) sizes #3 to #8.

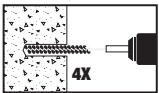

2b- Determine wire brush diameter (reference hole cleaning equipment selection table) and attach the brush with adaptor to a rotary drill tool or battery screwgun. Brush the hole with the selected wire brush a minimum of four times (4x). A brush extension (supplied by DEWALT) should be used for holes drilled deeper than the listed brush length.

- The wire brush diameter should be checked periodically during use. The brush must be replaced if it becomes worn or does not come into contact with the sides of the drilled hole.

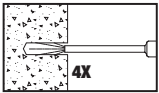

2c- Finally, blow the hole clean again a minimum of four times (4x)

- Use a compressed air nozzle (min. 90 psi) for anchor rod 3/8" to 1" diameter or reinforcing bar (rebar) sizes #3 to #8.
- When finished the hole should be clean and free of dust, debris, ice, grease, oil or other foreign material.

PREPARING



3- Check adhesive expiration date on cartridge label. Do not use expired product. Review Material Safety Data Sheet (MSDS) before use. Cartridge temperature must be between 32°F - 95°F (0°C - 35°C) when in use. Consideration should be given to the reduced gel time of the adhesive in warm temperatures.

- Attach a supplied mixing nozzle to the cartridge. Do not modify the mixer in any way and make sure the mixing element is inside the nozzle. Load the cartridge into the correct dispensing tool. A new mixing nozzle must be used for every working interruption longer than the published working times (reference gel time and curing time table) as well as for new cartridges.

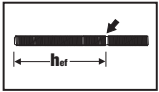

4- Prior to inserting the anchor rod or rebar into the filled bore hole, the position of the embedment depth has to be marked on the anchor. Verify anchor element is straight and free of surface damage.

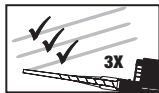

5- For new cartridges and nozzles; prior to dispensing adhesive into the anchor hole, squeeze out separately a minimum three full strokes of the mixed adhesive. Discard non-uniform adhesive until the adhesive is a consistent gray color. Do not attach a used nozzle when changing to a new cartridge.

- Review and note the published working and cure times (see gel time and curing time table) prior to injection of the mixed adhesive into the cleaned anchor hole.

INSTALLATION

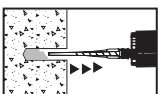

6- Fill the cleaned hole approximately two-thirds full with mixed adhesive starting from the bottom or back of the anchor hole. Slowly withdraw the mixing nozzle as the hole fills to avoid creating air pockets or voids. For embedment depth greater than 8" an extension nozzle must be used with the mixing nozzle.

- Piston plugs (see adhesive piston plug table) must be used with and attached to the mixing nozzle and extension tube for horizontal installations where embedment is greater than 8 inches and the drill bit size is larger than 5/8-inch. Insert piston plug to the back of the drilled hole and inject as described in the method above. During installation the piston plug will be naturally extruded from the drilled hole by the adhesive pressure.



Attention! Do not install anchors overhead or upwardly inclined.



7- The anchor should be free of dirt, grease, oil or other foreign material. Push clean threaded rod or reinforcing bar into the anchor hole while turning slightly to ensure positive distribution of the adhesive until the embedment depth is reached. Observe the gel (working) time.

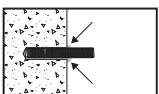

8- Be sure that the anchor is fully seated at the bottom of the hole and that some adhesive has flowed from the hole and all around the top of the anchor. If there is not enough adhesive in the hole, the installation must be repeated. Minor adjustments to the anchor may be performed during the gel time but the anchor shall not be moved after final placement and during cure.

CURING AND LOADING

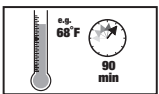

9- Allow the adhesive anchor to cure to the specified full curing time prior to applying any load (see gel time and curing time table).

- Do not disturb, torque or load the anchor until it is fully cured.



10- After full curing of the adhesive anchor, a fixture can be installed to the anchor and tightened up to the maximum torque (reference gel time and curing time table) by using a calibrated torque wrench.

- Take care not to exceed the maximum torque for the selected anchor.

REFERENCE INSTALLATION TABLES

Gel (working) Time and Curing Table

Temperature of Base Material		Gel (working) Time	Full Curing Time
°F	°C		
5	-15	120 minutes	48 hours
14	-10	90 minutes	24 hours
23	-5	90 minutes	14 hours
32	0	45 minutes	7 hours
41	5	35 minutes	4 hours
59	15	15 minutes	3 hours
68	20	8 minutes	90 minutes
86	30	4 minutes	60 minutes
95	35	3 minutes	45 minutes

For installations in base material temperatures between 5°F and 32°F the cartridge temperature must be conditioned to between 68°F and 95°F (20°C - 35°C)

Wire Brush Selection Table for AC50^{1,2}

ANSI Drill Bit Diameter (inch)	Nominal Wire Brush Size (inch)	Brush Length (inches)	Steel Wire Brush (Cat. #)	Blowout Tool
7/16	7/16	7	08284-PWR	Compressed air nozzle only Cat. #8292-PWR (min. 90 psi)
9/16	9/16	7	08285-PWR	
11/16	11/16	9	08286-PWR	
3/4	3/4	9	08278-PWR	
7/8	7/8	9	08287-PWR	
1	1	11	08288-PWR	
1-1/8	1-1/8	11	08289-PWR	

1. An SDS-plus adaptor (Cat. #08283-PWR) or Jacobs chuck style adaptor (Cat. #08296-PWR) is required to attach a steel wire brush to the drill tool.
2. A brush extension (Cat. #08282-PWR) must be used with a steel wire brush for holes drilled deeper than the listed brush length.

Adhesive Piston Plugs^{1,2}

ANSI Drill Bit Diameter (inch)	Plug Size (inch)	Piston Plug (Cat. #)	Premium Piston Plug (Cat. #)
11/16	11/16	08258-PWR	PFC1691515
3/4	3/4	08259-PWR	PFC1691520
7/8	7/8	08300-PWR	PFC1691530
1	1	08301-PWR	PFC1691540
1-1/8	1-1/8	08303-PWR	PFC1691550

1. All horizontal installations require the use of piston plugs where the embedment depth is greater than 8 inches and the drill bit size is larger than 5/8-inch.
2. A flexible plastic extension tube (Cat. #08281-PWR or #08297-PWR) or equivalent approved by DEWALT must be used with piston plugs.

ORDERING INFORMATION

AC50 Cartridges (10:1 mix ratio)

Cat. No.	Description	Pack Qty.	Pallet Qty.
08597SD-PWR	AC50 14 fl. oz. coaxial cartridge	12	540
08497-PWR	AC50 28 fl. oz. dual cartridge	8	240

A mixing nozzle is packaged with each cartridge.
AC50 mixing nozzles must be used to ensure complete and proper mixing of the adhesive.



Cartridge System Mixing Nozzles

Cat. No.	Description	Pack Qty.	Std. Carton
PFC1641600	Mixing nozzle (with 8" extension)	2	24
08294-PWR	Long mixing nozzle (with 8" extension)	2	24
08281-PWR	Mixing nozzle extension, 8" minimum	2	24



Dispensing Tools for Injection Adhesive

Cat. No.	Description	Pack Qty.	Std. Carton
08414-PWR	Standard metal manual tool	1	-
08494-PWR	28 oz. Standard metal manual tool	1	10
DCE595D1	28 oz. 20v Battery powered dispensing tool	1	-
08496-PWR	28 oz. Pneumatic tool	1	-



Hole Cleaning Tools and Accessories

Cat. No.	Description	Pack Qty.
08284-PWR	Wire brush for 7/16" or 1/2" ANSI hole, 7" length	1
08285-PWR	Wire brush for 9/16" ANSI hole, 7" length	1
08275-PWR	Wire brush for 5/8" ANSI hole, 7" length	1
08286-PWR	Wire brush for 11/16" ANSI hole, 9" length	1
08278-PWR	Wire brush for 3/4" ANSI hole, 9" length	1
08287-PWR	Wire brush for 7/8" ANSI hole, 9" length	1
08288-PWR	Wire brush for 1" ANSI hole, 11" length	1
08289-PWR	Wire brush for 1-1/8" ANSI hole, 11" length	1
08276-PWR	Wire brush for 1-1/4" ANSI hole, 11" length	1
08290-PWR	Wire brush for 1-3/8" ANSI hole, 11" length	1
08291-PWR	Wire brush for 1-1/2" ANSI hole, 11" length	1
08273-PWR	Wire brush for 1-5/8" ANSI hole, 11" length	1
08299-PWR	Wire brush for 1-3/4" ANSI hole, 11" length	1
08271-PWR	Wire brush for 2" ANSI hole, 11" length	1
08272-PWR	Wire brush for 2-3/16" ANSI hole, 11" length	1
08283-PWR	SDS-plus adapter for steel brushes	1
08296-PWR	Standard drill adapter for steel brushes (e.g. Jacobs Chuck)	1
08282-PWR	Steel brush extension, 12" length	1
08292-PWR	Air compressor nozzle with extension, 18" length	1

Piston Plugs for Adhesive Anchors

Cat. No.	Description	ANSI Drill Bit Dia.	Pack Qty.
08258-PWR	11/16" Plug	11/16"	10
08259-PWR	3/4" Plug	3/4"	10
08300-PWR	7/8" Plug	7/8"	10
08301-PWR	1" Plug	1"	10
08303-PWR	1-1/8" Plug	1-1/8"	10
08305-PWR	1-3/8" Plug	1-3/8"	10
08309-PWR	1-1/2" Plug	1-1/2"	10

Premium Piston Plugs

Cat. No.	Description	ANSI Drill Bit Dia.	Pack Qty.
PFC1691510	5/8" Plug	5/8"	1
PFC1691515	11/16" Plug	11/16"	1
PFC1691520	3/4" Plug	3/4"	1
PFC1691530	7/8" Plug	7/8"	1
PFC1691540	1" Plug	1"	1
PFC1691550	1-1/8" Plug	1-1/8"	1
PFC1691555	1-1/4" Plug	1-1/4"	1
PFC1691560	1-3/8" Plug	1-3/8"	1
PFC1691570	1-1/2" Plug	1-1/2"	1
PFC1691580	1-3/4" Plug	1-3/4"	1
PFC1691590	2" Plug	2"	1
PFC1691600	2-3/16" Plug	2-3/16"	1