

# DEWALT®

ENGINEERED BY **POWERS™**



**POWDER-ACTUATED FASTENING | CORDLESS FASTENING | GAS FASTENING**

## **DIRECT FASTENING** TECHNICAL GUIDE





<b>DIRECT FASTENING TECHNOLOGIES</b>	2
<b>POWDER-ACTUATED DIRECT FASTENING SYSTEMS</b>	
<b>POWDER FASTENERS</b>	13
<b>POWDER ASSEMBLIES</b>	26
<b>POWDER TOOLS AND ACCESSORIES</b>	35
<b>POWDER LOADS</b>	43
<b>CORDLESS DIRECT FASTENING SYSTEMS</b>	
<b>CORDLESS TOOLS</b>	47
<b>CORDLESS FASTENERS</b>	48
<b>CORDLESS ASSEMBLIES</b>	50
<b>CORDLESS ACCESSORIES</b>	51
<b>GAS DIRECT FASTENING SYSTEMS</b>	
<b>GAS TOOLS</b>	57
<b>GAS FASTENERS</b>	58
<b>GAS ASSEMBLIES</b>	61
<b>GAS FUEL CELLS AND ACCESSORIES</b>	63

# DIRECT FASTENING SYSTEM OVERVIEWS

## INTRODUCTION

Direct Fastening systems provide a cost-effective method of attaching fixtures in light-duty applications without pre-drilling holes. DEWALT systems consist of specially-designed fasteners and installation tools engineered to function together. This family of products provides users with optimum performance in fastening to concrete, concrete over steel deck, masonry, and structural steel.

DEWALT offers three Direct Fastening systems:

- Powder actuated fastening
- Cordless fastening
- Gas fastening

## GENERAL APPLICATIONS AND USES

- Attaching light gauge steel to concrete, concrete over steel deck, concrete masonry or steel
- Attaching wood members to concrete, concrete over steel deck, concrete masonry or steel
- Attaching accessories to concrete, concrete over steel deck, concrete masonry or steel
- Attaching ceiling clips wire and rods to concrete or steel
- Attaching threaded studs to concrete, concrete over steel deck, concrete masonry or steel

## POWDER-ACTUATED DIRECT FASTENING

Two types of powder-actuated tools have been used in the market which operate on different driving principles; direct acting and indirect acting. The basic design of the tools are similar in that each has a breech which holds the powder load and a barrel or guide mechanism to hold the fastener. However, the installation and safety characteristics of the tools are very different.

### DIRECT ACTING PRINCIPLE (HISTORICAL)

As the powder load is ignited in a direct acting tool, the expanding gases of the load act directly on the fastener to drive it down the barrel of the tool and into the base material. In a tool of this type, 100% of the energy developed by the powder load is transferred to the fastener. Penetration of the fastener into the base material is controlled primarily by the density of the base material and the load level selected. While the direct acting principle may allow fastenings to be made in very dense concrete and thick steel base materials, safety concerns have made the indirect principle the technology of choice. Powder-actuated tools using this principle are no longer commercially available.

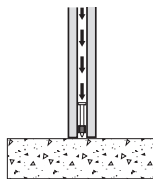

### INDIRECT ACTING PRINCIPLE (ACTIVE)

In a tool which operates using the indirect acting principle, the expanding gases of the ignited powder load act directly on a captive piston which is housed within the barrel of the tool. The piston drives the fastener into the base material providing better control over the penetration of the fastener. In a tool of this type, most of the energy developed by the powder load is retained by the piston. Penetration of the fastener into the base material is controlled by the design of the piston, the load level selected, and the density of the base material. All DEWALT powder actuated tools operate using the indirect acting principle and are classified as low velocity tools.

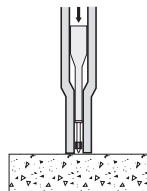

## SECTION CONTENTS

Introduction.....	2
Powder-Actuated Direct Fastening	2
Cordless Direct Fastening.....	3
Gas Direct Fastening.....	4
Fastener Types.....	4
Fastener Guidance and Material Properties.....	5
Functioning of Powder-Actuated Fasteners.....	5
Fastener Behavior.....	6
Base Material Suitability.....	7
Applied Load.....	7
Design Reference Guide for Concrete.....	8
Design Reference Guide for Steel.....	9

## TOOL CLASSIFICATION

Powder-actuated tools can be classified as low, medium, or high velocity. This classification system can apply to either direct or indirect acting tools and is based on a ballistic test. Using the strongest powder load and the lightest fastener commercially available from the manufacturer for a specific tool, the velocity of the tool is determined by measuring the average velocity of the fastener for ten individual tests. The velocity classifications based on ANSI A10.3 are as follows:

Low Velocity Tool: A tool in which the average test velocity does not exceed 328 feet per second (100 meters per second).

Medium Velocity Tool: A tool in which the average test velocity exceeds 328 feet per second (100 meters per second) but is less than 492 feet per second (150 meters per second). Medium velocity tools are no longer commercially available.

High Velocity Tool: A tool in which the average test velocity exceeds 492 feet per second (150 meters per second). High velocity tools are no longer commercially available.

## TOOL SAFETY

Powder-actuated fasteners must be installed by properly trained and licensed operators as described in ANSI Standard A 10.3. Authorized DEWALT representatives and distributors can offer complete training programs for end users. Contact your local DEWALT branch office or distributor for complete details.

**Note:** Only trained and licensed operators are allowed to use powder actuated tools. Summaries provided in this technical guide are for general information only. State, local or other regulations should also be followed, as applicable.

**POWDER LOADS**

The energy source used to drive a powder-actuated fastener into the base material is a self contained unit called a powder load. Specific load types are designed for each unique powder-actuated tool. DEWALT tools use cased powder loads in which the propellant is housed in a crimped metal case.

**POWDER LOAD IDENTIFICATION**

In the commercial market, cased powder loads are available in sizes ranging from .22, .25 and .27 calibers. The power level or strength of a cased powder load is identified using a level system. Power level 1/gray is the lowest with power level 6/purple being the highest. The following table shows this identification system (common level/color).

Power Level	Color Identification	
	Case Color	Load Color
1	Brass	Gray
2	Brass	Brown
3	Brass	Green
4	Brass	Yellow
5	Brass	Red
6	Brass	Purple

Powder loads are available as single units for single shot tools and collated in groups of 10 into plastic strips for semi-automatic tools. DEWALT tools use .22 caliber A, .25 caliber and .27 caliber crimped, rim fire powder loads having power levels ranging from 2 through 5. Consult the individual tool instructions for details on the caliber, range, and type of load.

**CORDLESS DIRECT FASTENING**

Cordless Direct Fastening systems provide a cost effective method of attaching light gage framing, fixtures and assemblies to concrete, masonry and steel base materials. These electro-mechanically actuated systems provide the contractor the ability to fasten to these base materials without hole spotting and pre-drilling holes. The cordless fastening technology was recently developed for commercial applications as an alternative to pneumatic, powder- actuated and gas fastening tools. Cordless Direct Fastening systems consist of specially designed fasteners, assemblies and installation tools which function in combination to provide speed and performance.

Cordless Direct Fastening systems have quickly become very popular with drywall and electrical trades where the fasteners are used for repetitive, light duty fastening. These systems can minimize the in place fastening cost as compared with other methods and can lessen the need for time consuming fastening layout. Cordless Direct Fastening systems also offer very lower recoil which reduces the stress and fatigue on the user. These systems are also extremely quiet; much more than other fastening means such as pneumatic and traditional powder actuated fastening. Cordless installation tools are completely portable and ideal for locations that are difficult to access as well as considered for additional reasons, such as: fastening where drilling is not allowed, concern/sensitivity to noise levels and for projects with restrictions using explosive or combustion devices.

**INDIRECT FASTENING PRINCIPLE**

Cordless Direct Fastening systems require special installation tools which are critical components of a successful fastening. The installation of fasteners using cordless tools uses the principle of

The crimped tip on the load retains the powder in the casing. Wadded loads which have a plug in the front of the casing should never be used in tools designed for use with crimped loads such as low velocity, piston tools. The wadding material can cause the tool to clog or jam. Rim fire refers to the method of actuation. In a rim fire powder load, the primer is contained in the rim of the casing. When the tool is fired, the firing pin strikes the rim causing the primer to ignite which in turn ignites the powder contained in the main portion of the load. The power level of DEWALT powder loads is marked on each box. As the number increases, the power level also increases. Power level is also indicated by the color of the box, label, and the color on each individual powder load.

**POWDER LOAD SELECTION**

Use of the proper power level is critical to the success of a powder actuated fastening. Prior to selecting the proper power level, conduct a center punch test as described in the upcoming section on base material suitability. To select the proper power level to be used with a specific fastener and base material, always perform a test firing using the lowest power level recommended for the tool being used. On tools which have a variable power control, use the lowest possible setting. If the lowest power level does not fully drive the fastener, try a powder load having the next higher power level. Continue this procedure until the proper fastener penetration is obtained.

a flywheel mechanism coupled with a battery. The power from the battery spins the flywheel which then drives a piston into the fastener head, which in turn drives the fastener into the base material providing good control over the penetration of the fastener. Cordless tools operate using the indirect acting principle. In a tool of this type, most of the energy developed by the flywheel is retained by the piston. Penetration of the fastener into the base material is primarily controlled by the design of the fastener, piston, flywheel, tool energy setting, and the density of the base material.

**TOOL SAFETY**

Usage of Cordless installation tools does not require licensing. However, the users of Cordless Direct Fastening systems should read, study and understand the operating instruction manual pertaining to the system, including safety precautions and warnings prior to use. Consideration of additional instruction may be necessary depending on the application and use. State, local or other regulations should also be followed, as applicable.

**BATTERIES**

Rechargeable batteries are the energy source for Cordless installation tools systems. Specific batteries are designed for each unique cordless fastening tool. In the commercial market, the battery type and size varies by system and manufacturer. Due to this, the amount of power also is different for each cordless fastening system. Currently, there is no industry standard for Cordless installation power rating power rating. Please refer to the manufacturer's published product information for appropriate batteries to be used with specific tools.

## GAS DIRECT FASTENING

Gas Direct Fastening systems provide a cost effective method of attaching light gage framing, fixtures and assemblies to concrete, masonry and steel base materials. These Gas Direct Fastening systems provide the contractor the ability to fasten to these base materials without hole spotting and pre-drilling holes. The Gas Direct Fastening systems was originally developed in the 1990's for commercial applications as an alternative to pneumatic and powder actuated tools. Gas Direct Fastening systems consist of specially designed fasteners, installation tools and fuel cells which function in combination to provide speed and performance.

Gas Direct Fastening systems are very popular with drywall, electrical and mechanical trades where the fasteners are used for repetitive, light duty fastening. These systems can minimize the in place fastening cost as compared with other methods and can lessen the need for time consuming fastening layout. Gas Direct Fastening systems also offer lower recoil which reduces the stress and fatigue on the user. These systems are also much quieter than other fastening means such as pneumatic and traditional powder actuated fastening. Gas Direct Fastening systems is completely portable and ideal for locations that are difficult to access and also where drilling is not allowed.

### INDIRECT FASTENING PRINCIPLE

Gas Direct Fastening systems require special installation tools and fuel cells which are critical components of a successful fastening. The installation of fasteners using Gas tools begins with dosing a precise amount of fuel into a combustion chamber from a proprietary fuel cell. The fuel in the chamber of the tool is ignited by a spark, typically produced by a battery. The combustion of the fuel and expanding

gases then drives a piston into the fastener head, which in turn drives the fastener into the base material providing good control over the penetration of the fastener. Gas tools operate using the indirect acting principle. In a tool of this type, most of the energy developed by the fuel combustion is retained by the piston. Penetration of the fastener into the base material is primarily controlled by the design of the fastener, piston, fuel cell/mix, combustion chamber, tool energy setting, and the density of the base material.

### TOOL SAFETY

Usage of Cordless installation tools does not require licensing. However, the users of gas fastening systems should read, study and understand the operating instruction manual pertaining to the system, including safety precautions and warnings prior to use. Consideration of additional instruction may be necessary depending on the application and use. State, local or other regulations should also be followed, as applicable.

### FUEL CELLS

Fuel cells are the energy source for gas fastening systems. Specific fuel cells are designed for each unique gas fastening tool. In the commercial market, the fuel cell design varies; the fuel mix and the amount of fuel dispensed for an individual fastening varies by system and manufacturer. Due to this, the amount of power also is different for each gas fastening system. Currently, there is no industry standard for gas fastening system power rating. Please refer to the manufacturer's published product information for appropriate fuel cells to be used with specific tools.

## FASTENER TYPES

Several fastener types are available including drive pins and threaded studs along with application-specific assemblies. See the individual product sections for specific information and performance data about various fastener/assembly sizes, types and styles; including but not limited to the following:

- Drive pins (single and collated)
- Washered pins
- Ceiling clip assemblies
- Threaded studs
- Rod hanger assemblies
- BX and EMT clips
- Rebar/dowel basket clips
- Stick-E™ Direct Fastening accessories

For Powder-Actuated Direct Fastening systems, according to ANSI A10.3 only those types of fasteners and powder loads as recommended by the tool manufacturer for a particular tool, or those providing the same level of safety and performance, shall be used. Cordless and Gas Direct Fastening systems are not currently regulated by OSHA or fall within the scope of ANSI requirements but the same general safety principles should be considered and applied where applicable.

## FASTENER GUIDANCE AND MATERIAL PROPERTIES

### FASTENER GUIDANCE

Fasteners have pre-mounted washers, plastic fluting or collation which hold the fastener centered in the tool guide prior to driving. During the driving process, the washers, plastic fluting or collation provide point guidance for the fastener. Generally, head guidance for single fasteners is provided by the diameter of the fastener head or threads. For collated fasteners, guidance is provided by the collation in the magazine. 1/4"-20 threaded studs also have a plastic cap to protect the threads of the fastener during the driving process while providing head guidance.

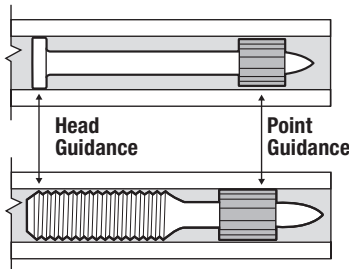

### FUNCTIONING OF POWDER-ACTUATED FASTENERS

#### FUNCTIONING IN CONCRETE

The load capacity of a power-actuated fastener when installed into concrete or masonry base materials is based on the following factors:

1. Strength of the base material
2. Hardness and concentration of the aggregate
3. Shank diameter, type and material of the fastener
4. Depth of embedment into the base material
5. Fastener spacing and edge distance

In addition to these factors, the installation tool and accessories can increase the performance of the fastener. Accessories can vary depending on the tool, such as a stop spall guard adaptor for powder actuated systems which can reduce the tendency of the concrete surface to spall during the driving action of the fastener.

When a power-actuated fastener is driven into concrete, it displaces the volume of concrete around the embedded area of the fastener shank. As this occurs, the concrete directly surrounding the fastener is compressed and in turn presses back against the shank of the fastener. Additionally, the driving action generates heat which causes particles within the concrete to fuse to the shank of the fastener. This combination of compression and fusion holds the fastener in the concrete base material. A similar action occurs when fastening into concrete masonry (CMU).

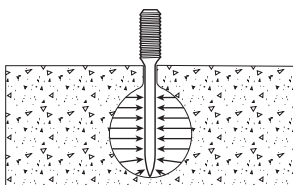

### MECHANICAL PROPERTIES

Power-actuated fasteners are subjected to extremely high stresses as they are driven into the base material. A key aspect of their design is to manufacture them from a material that is tough enough to prevent deformation of the fastener during the driving process with ductility to prevent fracture. DEWALT fasteners are specially manufactured using a proprietary process to meet these requirements. The fasteners are manufactured from high carbon steel and austempered to optimized core hardness for performance in the various base materials.

### CORROSION RESISTANCE

Power-actuated fasteners are typically designed to be used in a non-corrosive atmosphere unless application specific corrosion testing has been performed and/or the fastener has been specifically designed for such conditions. To reduce the possibility of the embrittlement of a heat treated part, the standard finish for all DEWALT fasteners is mechanically applied zinc meeting the requirements of ASTM B 695 providing an average minimum thickness of 5 microns (0.0002") with no supplementary coating, unless otherwise noted.

Generally, the performance of the fastener in a given concrete strength will increase with greater embedment depths in a certain range. Depending on the fastener style and base material strength, embedment depths range from 5/8" to 1-1/2". Embedment depths greater than this range, hard aggregate and/or very high compressive strength concrete often increase the likelihood of fastener bending or "fishhooking" which may decrease expected load capacities. For typical embedment depths achieved, refer to the individual product sections for specific information on performance data and load capacities.

During the driving action, some localized surface spalling of the concrete may occur. Normally, this is a surface effect which does not affect the performance of the fastener. However, it may pose an aesthetic problem for exposed applications where a fixture is not used. In cases such as this, two methods can be used to improve the appearance of the fastening. A stop spall adapter, available for some powder actuated systems, can be mounted on the powder actuated tool to help to reduce surface spalling. Another method used is to drive the fastener through a steel washer to improve the appearance of the application.

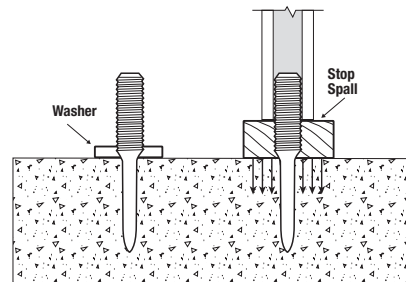

## FUNCTIONING IN STEEL

The load capacity of a power-actuated fastener when installed into steel base materials is based on the following factors:

1. Thickness of the steel
2. Tensile strength and hardness of the steel
3. Shank diameter, type and material of the fastener
4. Depth and penetration in the steel
5. Fastener spacing and edge distance

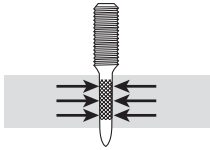

When a power-actuated fastener is driven into steel, it displaces the steel laterally 360 degrees around the shank of the fastener. Since steel is an elastic material, it presses back against the shank of the

fastener to hold it in place. As the diameter of the fastener shank is increased, the load capacity obtained will generally increase provided the steel thickness is sufficient to accept the fastener. To further increase fastener performance in steel, some fasteners have a knurled shank which allows the steel to form a key lock into the grooves to provide higher capacities than those obtained with a smooth shank. For typical performance, the fastener point should

penetrate the steel. Normally, an 1/8" to 1/4" is allowed for the point length. An increase in performance can normally be expected until the fastener no longer completely penetrates through the steel. At this point, the elastic properties of the steel may cause a compression force to be developed at an angle against the fastener point which can reduce load capacity.

However, this can be subject to the fastener type and in thicker steel base materials, adequate load capacities may be obtained for applications in which the point of the fastener does not fully penetrate the steel. Job site performance tests are recommended if data is not available or provided from the manufacturer.

Fasteners should not be used in areas that have been welded or cut with a torch as these procedures may have caused local hardening of the steel. Over driving of the fastener should be avoided as the rebound created may reduce the load capacity or cause damage to both the fastener and the tool. When fastening into unsupported long steel members, it may be necessary to provide support in the area of the fastening to prevent spring action which can cause inconsistent penetration and a reduction in load capacity.

## FASTENER BEHAVIOR

### BASE MATERIAL FAILURE / FASTENER PULLOUT

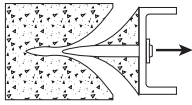

The fastener pulls out of the base material when subjected to a tension load. In concrete, a cone type or pullout failure can be expected while in steel the fastener typically pulls out cleanly.

### SHANK FAILURE

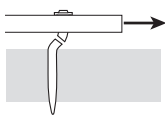

The shank of the fastener is broken due to an applied lateral load such as shear. This can also happen from loading due to bending.

### TIGHTENING FAILURE

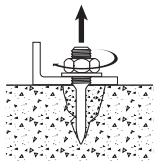

On threaded stud fasteners, the tightening torque applied must be limited to prevent over tightening of the connection. This will prevent the development of a clamping force greater than the tension or pullout load resistance of the fastener.

### PULLOVER FAILURE

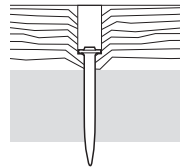

The fixture or material fastened pulls over the head of the fastener. This is a common occurrence when fastening lumber or thin metal materials. To help improve pullover resistance for applications such as this, DEWALT power actuated fasteners are available with a top hat and also with various pre-mounted steel washers.

### PRYOUT FAILURE

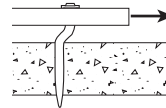

The fastener pries out of the base material when subjected to a shear load. In concrete, this can occur more frequently with fasteners installed with short embedment; in steel this failure mode is not very common.

### BEARING FAILURE

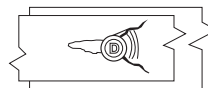

The fixture or material fastened tears as a lateral load is applied and is pulled over the head of the fastener.



## BASE MATERIAL SUITABILITY

While power-actuated fasteners can be used successfully in concrete, lightweight concrete, certain masonry materials, ASTM A36 and A572 steel, some materials are completely unsuitable. Fasteners should never be fired into hard or brittle materials such as cast iron, tile, fired clay brick, glass, or rock. These materials can shatter easily resulting in a potential safety hazard. In addition, soft base materials such as wallboard, plaster, or wood are not appropriate as the fastener could pass completely through these materials. The user should never guess when fastening into any base material.

For powder-actuated fastening, a Center Punch Test should always be performed to help determine the suitability of the base material. This may also be considered for cordless and gas fastening systems. This test is relatively simple and can help to ensure a safe, successful fastening. Be sure to use the appropriate eye protection when performing this test. To begin, select the fastener to be used for the job. Then place the point of the fastener against the proposed base material.

Strike the fastener with a single hammer blow and then examine the point. If the point of the fastener is not blunted and the base material has a clear point indentation, it is acceptable to proceed with the first test installation. Use of a fastening system is not recommended if the following occurs during the Center Punch Test:

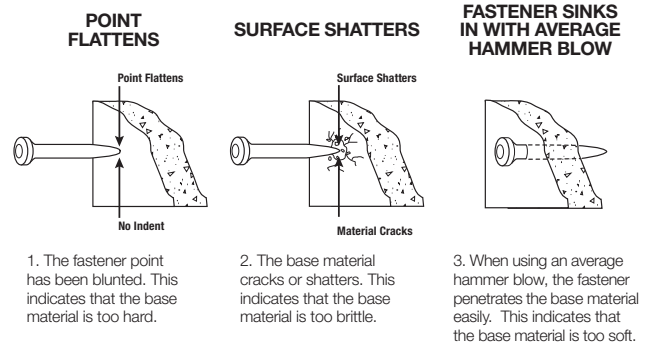

## APPLIED LOAD

The type of load and the manner in which it is applied by the fixture or other attachment is a primary consideration in the selection of a power actuated fastener. Power-actuated fastening systems provide a cost effective method of attaching fixtures for light duty, static load conditions. The load capacities for power actuated fasteners published in this technical guide represent the results of laboratory testing conducted according to ASTM Standards E1190, *Standard Test Methods for Strength of Power Actuated Fasteners Installed in Structural Members*; and ICC-ES AC70, *Power Actuated Fasteners Driven into Concrete, Steel and Masonry Elements*. The suitability of a fastener for a specific application should be determined by a qualified design professional responsible for the product installation.

### TENSION LOAD

A tension load is applied directly in line with the axis of the fastener.

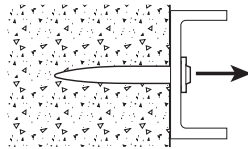

### SHEAR LOAD

A shear load is applied perpendicular to the fastener directly along the surface of the base material.

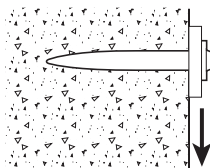

## LOADING DUE TO BENDING

The effect of bending resulting from the application of shear loading should be considered. This can occur in softer material such as lumber used for sill plates or when shims or spacers are placed between the fixture and the base material. In situations such as this, the load is applied at an offset distance from the surface of the base material creating a lever type action on the fastener.

When a bending load is applied to a fastener, it is often the physical strength of the fastener material, not the tension or shear load capacities, that limit the strength of the connection. For sill plate applications, DEWALT publishes test data based on the use of 2x lumber to develop the capacities. The allowable bending load should be calculated by a design professional based on the fastener material and strength specifications. For power-actuated fasteners with a step shank or a threaded section (e.g. threaded stud), it is important to remember that the point of maximum stress is at the interface of the shank and the base material. For example, when calculating the bending load for a fastener such as a threaded stud fastener, it is important to use the shank diameter in calculations, not the root diameter of the threads (in this case the smaller cross-section of the fastener would be used).

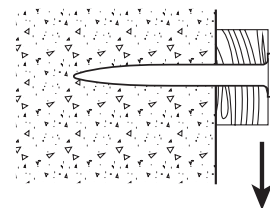

## DESIGN REFERENCE GUIDE FOR CONCRETE

### ALLOWABLE LOAD CAPACITIES

The allowable load capacity which may be applied to a power-actuated fastener is based on applying a safety factor to the average ultimate load capacity obtained from testing according to ASTM Standards E1190 and ICC-ES AC70. One purpose of the safety factor is to allow for field variations which may differ from the testing conditions in the laboratory. An example is the type and strength of the base material. In concrete and masonry materials, the values for allowable loads are based on applying a minimum safety factor of 5:1 to the ultimate loads. Loads are based on testing fasteners installed in base materials having the designated strength at the time of installation. Values are for the fastener only, connected parts and attachments must be investigated separately. Due to the inherent variability of power-actuated fasteners installed in concrete or masonry materials, use of multiple fasteners is recommended to increase reliability. The design data listed in the tables are allowable load capacities based on the noted safety factors. These safety factors are based on industry standards and may need to be increased based on the application requirements, life safety or local codes as determined by the design professional responsible for the product installation. Proper spacing and edge distance guidelines must be followed.

### BASE MATERIAL STRENGTH

As discussed earlier in this technical guide, the strength of concrete and masonry base materials can vary widely. For installations in concrete, load capacities are published for power-actuated fasteners in normal-weight concrete in various compressive strength ranges. Linear interpolation of the data to calculate load capacities for fasteners installed in intermediate concrete strengths is permitted. Normally, the load capacities can be expected to increase as the compressive strength of the concrete base material increases. However, high compressive strength concrete or concrete with very hard aggregate may not be suitable for power actuated fastenings. Job site installation tests are recommended to determine fastener suitability. For lightweight concrete, values are published for fasteners installed directly into concrete and through the soffit of steel deck into concrete. For masonry base materials, the published load capacities are based on testing in a wall constructed from ASTM C90, concrete masonry block (CMU). Since the consistency of masonry block can vary widely, (e.g. type and strength of block, mortar and grout, as applicable), these values should be used as a guide. Job site tests are recommended to determine actual load capacities when used in masonry walls.

### BASE MATERIAL THICKNESS

Concrete base material should be at least three times (3x) as thick as the fastener embedment penetration unless specific fastener testing has been conducted to qualify the condition and location. If the concrete is too thin, the compressive forces forming at the fasteners point

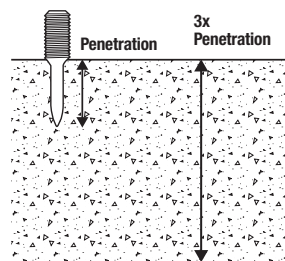

can cause the free face of the concrete to break away. This can create a dangerous condition from flying concrete and/or the fastener and can also result in a reduction of fastener holding power or

possibly failure. For applications in the face shell of concrete masonry block, the wall thickness should be 1-1/4" minimum and the power actuated system being considered has been specifically tested to qualify the condition and location.

### EDGE DISTANCE

As a general rule, do not fasten closer than 3" from the edge of concrete unless specific fastener testing has been conducted to qualify the condition and location. If the concrete cracks, the fastener may not hold. Closer edge distances for applications such as sill plates may be permitted if specific fastener testing has been conducted to qualify the location.

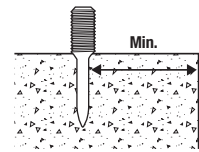

### SPACING

As a general rule, do not fasten closer than 3" from the edge of concrete unless specific fastener testing has been conducted to qualify the condition and location. If the concrete cracks, the fastener may not hold. Closer edge distances for applications such as sill plates may be permitted if specific fastener testing has been conducted to qualify the location.

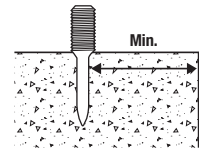

### LENGTH SELECTION

For permanent applications using fasteners in concrete, first determine the thickness of the fixture to be fastened. To this, add the required embedment or penetration into the base material. This will be the fastener shank length required. For applications in the face shell of concrete masonry block, it is recommended to select a fastener length which will result in an embedment less than the thickness of the face shell after installation (and considering thickness of the fixture).

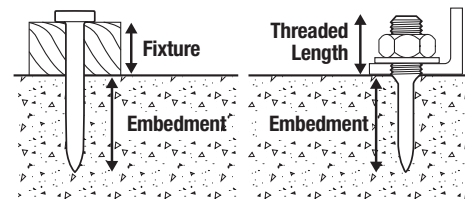

For applications with threaded studs, the shank length required is equal to the embedment depth required. To determine the minimum threaded length, add the thickness of the fixture and the nut/washer thickness. The nut and washer thickness is equal to the nominal thread diameter. Do not over tighten threaded parts. Maximum tightening torque values are listed in the table below. Use of a nut setter is recommended to reduce the possibility of over tightening the fasteners. For critical applications, consideration of mandatory job site tests are recommended.

Maximum Torque for 1/4" Threaded Stud (ft.-lbs.)	Maximum Torque for 3/8" Threaded Stud (ft.-lbs.)
2	4

## DESIGN REFERENCE GUIDE FOR STEEL

### ALLOWABLE LOAD CAPACITIES

The allowable load capacity which may be applied to a power-actuated fastener is based on applying a safety factor to the average ultimate load capacity obtained from testing according to ASTM Standards E1190 and ICC-ES AC70. One purpose of the safety factor is to allow for field variations which may differ from the testing conditions in the laboratory. An example is the type and strength of the base material. In steel materials, the values listed are based on a safety factor of 5:1 to the ultimate loads. Values are for the fastener only, connected parts must be investigated separately. Use of multiple fasteners is recommended to increase reliability. The design data listed in the tables are allowable load capacities based on the safety factors noted below each table. This safety factor is based on industry standards and may need to be increased based on the application, life safety or local code requirements as determined by the design professional responsible for the product installation. Proper spacing and edge distance guidelines must be followed.

### BASE MATERIAL STRENGTH

Unless otherwise noted, the published allowable load capacities are based on testing conducted in structural steel with the fastener point penetrating the steel member. For use in higher strength steel, or in applications where the point of the fastener will not penetrate a thickness of steel greater than those listed in the tables, job site tests are recommended to determine the suitability of the application and the load capacities (unless published data is available for the specific fastener).

### BASE MATERIAL THICKNESS

Steel base materials should typically be a minimum of 1/8" in thickness.



### EDGE DISTANCE

For installations in steel, 1/2" is the recommended minimum edge distance, unless specific fastener testing has been conducted to qualify the condition and location.

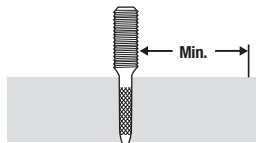

### SPACING

The recommended minimum distance between fastenings is 1-1/2" center to center for installations in steel, unless specific fastener testing has been conducted to qualify the condition and location.

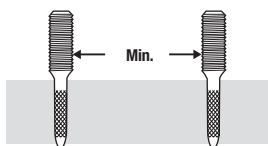

### LENGTH SELECTION

For permanent applications when using pins in steel, first determine the thickness of the fixture to be fastened. To this, add the thickness of the steel base material plus an 1/8" to 1/4" to allow for point penetration. This will typically be the minimum fastener shank length required unless performance data and/or testing is available for applications where the point of the fastener will not penetrate the steel. It is not recommended to select a fastener length longer than that required for the application. For example, in installations into thick steel base materials where the fastener does not penetrate the backside of the member, using lengths much longer than required can cause the fastener to stand proud from the fixture/surface (or possibly buckle depending on the power of the fastening system and the diameter of the fastener). For installations where the fastener does penetrate the backside of the member, an excessively long shank can also burnish or polish the hole created in the steel resulting in a reduction in load capacity.

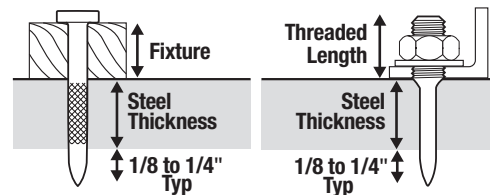

For applications with threaded studs, the shank length required is equal to the thickness of the steel base material plus an 1/8" to 1/4" to allow for point penetration. This will typically be the minimum fastener shank length required unless performance data and/or testing is available for applications where the point of the fastener will not penetrate the steel. Again, it is not recommended to select a shank length longer than that required for the application for the reasons previously given. To determine the minimum threaded length, add the thickness of the fixture and the nut / washer thickness. The nut and washer thickness is equal to the nominal thread diameter.

Do not over tighten threaded studs, the maximum tightening torque is listed in the table below. Use of a nut setter is recommended to reduce the possibility of over tightening the fasteners. For critical applications, consideration of mandatory job site tests are recommended.

Base Material Thickness (in.)	Max. Torque for 1/4" Threaded Stud (ft.-lbs.)	Max. Torque for 3/8" Threaded Stud (ft.-lbs.)
1/8	2	4
3/16	4	6
1/4	6	10
3/8	8	12

Note: For steel base material thicknesses where point penetration is not possible, see the performance data for specific fasteners in steel; or perform a job site test to determine the suitability of the application and load capacities.



**POWDER-ACTUATED DIRECT FASTENING SYSTEMS**



<b>SELECTION GUIDE</b>	12
<b>POWDER-ACTUATED FASTENERS</b>	
<b>CSI SPIRAL DRIVE PINS</b>	13
<b>0.300" HEAD DRIVE PINS</b>	18
<b>8MM HEAD DRIVE PINS</b>	23
<b>CEILING CLIP ASSEMBLIES</b>	26
<b>THREADED STUDS, ROD HANGERS AND OTHER ASSEMBLIES</b>	31
<b>POWDER-ACTUATED TOOLS</b>	
<b>P1000 / T1000 TOOLS</b>	35
<b>P2201 TOOL</b>	36
<b>P35S TOOL</b>	37
<b>P3500 TOOL</b>	38
<b>PA3500 TOOL</b>	39
<b>P3600 TOOL</b>	40
<b>SNIPER TOOL</b>	41
<b>DFD270 TOOL</b>	42
<b>POWDER-ACTUATED LOADS</b>	
<b>.22 CALIBER LOADS</b>	43
<b>.27 CALIBER LOADS</b>	43
<b>.25 CALIBER LOAD STRIPS</b>	43
<b>.27 CALIBER LOAD STRIPS</b>	43

**POWDER-ACTUATED DIRECT FASTENING SELECTION GUIDE**

Pins / Fasteners Description		Dimensions		Base Material					DEWALT Tools							Approvals & Listings
		Shank Diameter	Shank Length	Concrete	Lightweight Concrete	Concrete Over Steel Deck	Concrete Masonry (CMU)	Steel	P1000 / T1000	P2201	P35s	P3500 / PA3500	P3600	Sniper	DFD270	
CSI Spiral Drive Pins	CSI Spiral Drive Pins	0.157"	16mm to 37mm (5/8" to 1-1/2")	●	●	●	●	●		○	●	●		●	●	ICC-ES ESR-2024
		0.157"	52mm to 72mm (2" to 2-7/8")	●	●	●	○	○		○		●			●	ICC-ES ESR-2024
	CSI Spiral Pins with Tapered Shank	0.145"	13mm to 16mm (1/2" to 5/8")	○	○	○	○	●		○		●			●	ICC-ES ESR-2024
	CSI Spiral Drive Pins with Washer	0.157"	19mm to 32mm (3/4" to 1-1/4")	●	●	●	●	●		○	●	●			●	ICC-ES ESR-2024
		0.157"	62mm to 72mm (2-1/2" to 2-7/8")	●	●	●	○	○		○		●			●	ICC-ES ESR-2024
0.300" Head Drive Pins	0.300" Head Pin (including MG pins)	0.145"	1/2" to 1-1/2"	●	●	●	●	●	●	●	●	●		●	●	ICC-ES ESR-2024
		0.145"	2" to 3"	●	●	●	○	○	●	●		●			●	ICC-ES ESR-2024
	0.300" Head Pin with Washer (including MG pins)	0.145"	1/2" to 1"	●	●	●	●	●	●	●	●	●		●	●	ICC-ES ESR-2024
		0.145"	3/4" to 1-1/2"	●	●	●	●	●	●	●	●	●		●	●	ICC-ES ESR-2024
	0.300" Head Ballistic Point Pin	0.145"	2" to 3"	●	●	●	○	○	●	●		●			●	ICC-ES ESR-2024
8mm Head Drive Pins	8mm Head Pin with Top Hat	0.145"	16mm to 27mm (5/8" to 1")	●	●	●		●	●	●	●	●		●	●	ICC-ES ESR-2024
		0.145"	27mm to 37mm (1" to 1-1/2")	●	●	●		●	●	●	●	●		●	●	ICC-ES ESR-2024
	8mm Head Pin with Washer	0.145"	42mm to 72mm (1-5/8" to 2-7/8")	●	●	●		○	●	●		●			●	ICC-ES ESR-2024
Ceiling Clips	CSI Spiral Ceiling Clip (8mm Head Pin)	0.157"	22mm to 32mm (7/8" to 1-1/4")	●	●	●		●			●	●		●	●	ICC-ES ESR-2024
	Standard and Extended Length Ceiling Clips (0.300" & 8mm Head Pins)	0.145"	7/8" to 1-1/4" (22mm to 32mm)	●	●	●		●		○	●	●		●	●	ICC-ES ESR-2024
	Economy Ceiling Clip (0.300" Head Pin)	0.145"	7/8" to 1-1/4"	●	●	●		●		○	●	●		●	●	ICC-ES ESR-2024
	Ballistic Ceiling Clip (0.300" Head Pin)	0.150"	7/8"	●	●	●		●		○	●	●		●	●	ICC-ES ESR-2024
		0.181/0.150"	1-1/4"	●	●	●		●			●	●		●	●	
Threaded Studs	1/4"-20 Threaded Stud (UNC)	0.145"	1/2" to 1-1/4"	●	●	●	●	●	○	○	●	●		●	●	ICC-ES ESR-2024
	3/8"-16 Threaded Stud (UNC)	0.205"	3/4" to 1-1/4"	●	●	●	○	●					●			ICC-ES ESR-2024
Hangers	Post Nut Hangers (0.300" Head Pins)	0.145"	1-1/8" to 1-1/4"	●	●	●	○	●		○	●	●		●	●	ICC-ES ESR-2024
	Rod Hangers (0.300" Head Pins)	0.145"	1-1/8" to 1-1/4"	●	●	●	○	●		○	●	●		●	●	
Other Assemblies	BX-EMT Conduit Clip (0.300" & 8mm Head Pins)	0.145"	1" to 1-1/4" (27mm to 32mm)	●	●	●	●	●	●	●	●	●		●	●	
	Rebar/Dowel Basket Clip (8mm Head Pins)	0.145"	37mm to 72mm (1-1/2" to 2-7/8")	●	●	●	○	○	●	●		●			●	

● Suitable ○ May be Suitable

Collated fasteners can only be loaded into the DFD270 with magazine.

MG = Mechanical Galvanized

**GENERAL INFORMATION**

**CSI SPIRAL DRIVE PINS**

High Performance Domed Head Pins

**PRODUCT DESCRIPTION**

CSI Spiral Drive Pins are designed for permanently fastening a fixture to concrete, concrete over steel deck, concrete masonry walls and A36 or A572 / A992 structural steel. The fasteners are manufactured with an 8mm head and 0.157" diameter shank in various lengths. A spiral knurled shank design provides consistent optimized performance in steel base materials. For single fasteners, a plastic washer is mounted on the pin shank to retain the drive pin in the barrel of the tool and provide centered guidance during the driving operation. The fasteners are also available in collated strips.

**GENERAL APPLICATIONS AND USES**

- Attaching light gauge steel to concrete, concrete over steel deck, concrete masonry or steel
- Attaching wood members to concrete, concrete masonry or steel
- Attaching accessories, fixtures and components to concrete, concrete over steel deck, concrete masonry or steel
- Sill plate and perimeter anchorage

**APPROVALS AND LISTINGS**

- International Code Council, Evaluation Service (ICC-ES), ESR-2024
- Code compliant with the International Building Code/International Residential Code: 2018 IBC/IRC, 2015 IBC/IRC, 2012 IBC/IRC, and 2009 IBC/IRC
- Tested in accordance with ASTM E1190 and ICC-ES AC70 for use in concrete, lightweight concrete, concrete over steel deck, concrete masonry and steel

**GUIDE SPECIFICATION**

- CSI Divisions: 03 15 00 - Concrete Accessories, 05 05 23 - Metal Fastenings, 06 05 23 - Wood, Plastic and Composite Fastenings, 09 22 16.23 - Fasteners. Powder-driven fasteners shall be CSI spiral drive pins as supplied by DEWALT, Towson, MD. Fasteners shall be installed in accordance with published instructions and the Authority Having Jurisdiction.

**SELECTION GUIDE**

Pin / Fastener Description	Dimensions		Base Material					DEWALT Tools						Approvals & Listings
	Shank Diameter	Shank Length	Concrete	Lightweight Concrete	Concrete over Steel Deck	Concrete Masonry (CMU)	Steel	P1000 / T1000	P2201	P35s	P3500 / PA3500	Shliper	DFD270	
CSI Spiral Drive Pins	0.157"	16mm to 37mm (5/8" to 1-1/2")	●	●	●	●	●		○	●	●	●	●	ICC-ES ESR-2024
	0.157"	52mm to 72mm (2" to 2-7/8")	●	●	●	○	○		○		●		●	ICC-ES ESR-2024
CSI Spiral Pins with Tapered Shank	0.145"	13mm to 16mm (1/2" to 5/8")	○	○	○	○	●		○	●	●	●	●	ICC-ES ESR-2024
CSI Spiral Drive Pins with Washer	0.157"	19mm to 32mm (3/4" to 1-1/4")	●	●	●	●	●		○	●	●	●	●	ICC-ES ESR-2024
	0.157"	62mm to 72mm (2-1/2" to 2-7/8")	●	●	●	○	○		○		●		●	ICC-ES ESR-2024

● Suitable ○ May be Suitable

Collated fasteners can only be loaded into the DFD270 with magazine.

**SECTION CONTENTS**

General Information.....13  
 Selection Guide.....13  
 Performance Data.....14  
 Ordering Information.....17



CSI SPIRAL PIN



CSI SPIRAL PIN COLLATED



CSI SPIRAL PINS WITH WASHER

**SUITABLE BASE MATERIALS**

- Normal-weight concrete
- Lightweight concrete
- Concrete over steel deck
- Grouted concrete masonry (CMU)
- Hollow concrete masonry (CMU)
- Steel

**FASTENER SIZE RANGE**

- 1/2" (13mm) length through 2-7/8" (72mm) length

**CODE LISTED**  
ICC-ES ESR-2024  
CONCRETE, MASONRY, STEEL

**POWDER-ACTUATED**

**CSI SPIRAL DRIVE PINS**  
High Performance Domed Head Pins

## PERFORMANCE DATA

### Allowable Load Capacities for CSI Spiral Fasteners in ASTM A36 Steel<sup>1,2,3,7,8</sup>

Fastener Description		Nominal Steel Thickness (inch)									
		1/8		3/16		1/4		3/8		≥ 1/2 <sup>4,5,6</sup>	
		Tension lbs. (kN)	Shear lbs. (kN)	Tension lbs. (kN)	Shear lbs. (kN)	Tension lbs. (kN)	Shear lbs. (kN)	Tension lbs. (kN)	Shear lbs. (kN)	Tension lbs. (kN)	Shear lbs. (kN)
CSI Spiral Drive Pin (0.157" Shank)		280 (1.2)	540 (2.4)	515 (2.3)	585 (2.6)	735 (3.3)	535 (2.4)	615 (2.7)	495 (2.2)	535 (2.4)	565 (2.5)
CSI Spiral Taper Shank Pin (0.157" Shank)	1/2-inch long	-	-	-	-	210 (0.9)	390 (1.7)	240 (1.1)	390 (1.7)	245 (1.1)	480 (2.1)
	5/8-inch long	-	-	-	-	265 (1.2)	465 (2.1)	290 (1.3)	465 (2.1)	320 (1.4)	480 (2.1)

- Fastener capacities are based on the base steel with a minimum yield strength (F<sub>y</sub>) of 36 ksi and a minimum ultimate tensile strength (F<sub>u</sub>) of 58 ksi. The pointed portion of the fastener must penetrate the steel member unless otherwise noted.
- The tabulated tension and shear values are for the fasteners only. Steel or wood members connected to the steel substrate must be investigated for compliance with the applicable code.
- Allowable load capacities are calculated using minimum required factors of safety in accordance with ICC-ES AC70; the minimum applied factor of safety is 5.0. Consideration of additional safety factors may be necessary depending on the application such as life safety.
- The step shank fasteners with 0.157 inch shank must be embedded a minimum of 0.50 inch into the steel; fastener point penetration through the steel is not necessary provided the minimum embedment is achieved.
- The 1/2-inch long tapered fasteners with 0.145 inch shank must be embedded a minimum of 0.43 inch into the steel; fastener point penetration through the steel is not necessary provided the minimum embedment is achieved.
- The 5/8-inch long tapered fasteners with 0.145 inch shank must be embedded a minimum of 0.45 inch into the steel; fastener point penetration through the steel is not necessary provided the minimum embedment is achieved.
- Fasteners must have a minimum spacing distance of 1-1/2 inches and a minimum edge distance of 1/2 inch in accordance with ASTM E 1190. Consideration of smaller spacing distances may be given based on application or jobsite testing.
- Multiple fasteners are recommended for any attachment for increased reliability.

### Allowable Load Capacities for CSI Spiral Fasteners in ASTM A572 or A992 Steel<sup>1,2,3,7,8</sup>

Fastener Description		Nominal Steel Thickness (inch)									
		1/8		3/16		1/4		3/8		≥ 1/2 <sup>4,5,6</sup>	
		Tension lbs. (kN)	Shear lbs. (kN)	Tension lbs. (kN)	Shear lbs. (kN)	Tension lbs. (kN)	Shear lbs. (kN)	Tension lbs. (kN)	Shear lbs. (kN)	Tension lbs. (kN)	Shear lbs. (kN)
CSI Spiral Drive Pin (0.157" Shank)		325 (1.4)	510 (2.3)	550 (2.4)	630 (2.8)	795 (3.5)	580 (2.6)	660 (2.9)	535 (2.4)	580 (2.6)	610 (2.7)
CSI Spiral Taper Shank Drive Pin (0.145" Shank)	1/2-inch long	-	-	-	-	210 (0.9)	390 (1.7)	240 (1.1)	390 (1.7)	245 (1.1)	480 (2.1)
	5/8-inch long	-	-	-	-	265 (1.2)	465 (2.1)	290 (1.3)	465 (2.1)	320 (1.4)	480 (2.1)

- Fastener capacities are based on the base steel with a minimum yield strength (F<sub>y</sub>) of 50 ksi and a minimum ultimate tensile strength (F<sub>u</sub>) of 65 ksi. The pointed portion of the fastener must penetrate the steel member unless otherwise noted.
- The tabulated tension and shear values are for the fasteners only. Steel or wood members connected to the steel substrate must be investigated for compliance with the applicable code.
- Allowable load capacities are calculated using minimum required factors of safety in accordance with ICC-ES AC70; the minimum applied factor of safety is 5.0. Consideration of additional safety factors may be necessary depending on the application such as life safety.
- The fasteners with 0.157 inch shank must be embedded a minimum of 0.50 inch into the steel; fastener point penetration through the steel is not necessary provided the minimum embedment is achieved.
- The 1/2-inch long tapered fasteners with 0.145 inch shank must be embedded a minimum of 0.43 inch into the steel; fastener point penetration through the steel is not necessary provided the minimum embedment is achieved.
- The 5/8-inch long tapered fasteners with 0.145 inch shank must be embedded a minimum of 0.45 inch into the steel; fastener point penetration through the steel is not necessary provided the minimum embedment is achieved.
- Fasteners must have a minimum spacing distance of 1-1/2 inches and a minimum edge distance of 1/2 inch in accordance with ASTM E 1190. Consideration of smaller spacing distances may be given based on application or jobsite testing.
- Multiple fasteners are recommended for any attachment for increased reliability.

### Allowable Load Capacities for CSI Spiral Fasteners in Normal-Weight Concrete<sup>1,2,3,4,5,6</sup>

Fastener Description	Min. Embed. Depth in. (mm)	Minimum Concrete Compressive Strength, f 'c							
		2,500 psi		3,000 psi		4,000 psi		6,000 psi	
		Tension lbs (kN)	Shear lbs (kN)	Tension lbs (kN)	Shear lbs (kN)	Tension lbs (kN)	Shear lbs (kN)	Tension lbs (kN)	Shear lbs (kN)
CSI Spiral Drive Pin (0.157" Shank)	3/4 (19)	120 (0.5)	170 (0.8)	130 (0.6)	190 (0.8)	270 (1.2)	380 (1.7)	80 (0.4)	120 (0.5)
	1 (25)	190 (0.8)	245 (1.1)	225 (1.0)	280 (1.2)	270 (1.2)	520 (2.3)	205 (0.9)	300 (1.3)
	1-1/4 (32)	310 (1.4)	385 (1.7)	340 (1.5)	420 (1.9)	475 (2.1)	575 (2.6)	205 (0.9)	380 (1.7)

- Fasteners must not be driven until the concrete has reached the minimum designated compressive strength. Linear interpolation may be used to determine allowable loads for intermediate compressive strengths.
- The tabulated tension and shear values are for the fasteners only. Steel or wood members connected with the substrate must be investigated for compliance with the applicable code.
- Allowable load capacities are calculated using minimum required factors of safety in accordance with ICC-ES AC70; the minimum applied factor of safety is 5.0. Consideration of additional safety factors may be necessary depending on the application such as life safety.
- Concrete member thickness must be a minimum of three times the fastener embedment depth.
- Fasteners must have a minimum spacing distance of 4 inches and a minimum edge distance of 3-1/2 inches in accordance with ASTM E 1190. Consideration of smaller spacing and edge distances may be given based on application or jobsite testing.
- Multiple fasteners are recommended for any attachment for increased reliability.



**Load Capacities for CSI Spiral Fasteners in Lightweight Concrete and Sand-Lightweight Concrete over Steel Deck (3-inch Deep Profile)**<sup>1,2,3,8,9,10</sup>

Fastener Description	Minimum Embed. Depth in. (mm)	Minimum Concrete Compressive Strength, f 'c = 3,000 psi					
		Directly into Concrete <sup>1,5</sup>		Through Soffit of Steel Deck into Concrete			
		Tension lbs (kN)	Shear lbs (kN)	Upper Flute <sup>6,7</sup>		Lower Flute <sup>6,7</sup>	
Tension lbs (kN)	Shear lbs (kN)			Tension lbs (kN)	Shear lbs (kN)		
CSI Spiral Drive Pin (0.157" Shank)	3/4 (19)	185 (0.8)	270 (1.2)	185 (0.8)	430 (1.9)	130 (0.6)	355 (1.6)
	1 (25)	260 (1.2)	375 (1.7)	250 (1.1)	510 (2.3)	190 (0.8)	355 (1.6)
	1-1/8 (29)	350 (1.6)	425 (1.9)	250 (1.1)	560 (2.5)	200 (0.9)	425 (1.9)
	1-1/4 (32)	350 (1.6)	440 (2.0)	350 (1.6)	610 (2.7)	200 (0.9)	450 (2.0)
	1-1/2 (38)	460 (2.0)	520 (2.3)	475 (2.1)	610 (2.7)	205 (0.9)	450 (2.0)

1. Fasteners must not be driven until the concrete has reached the minimum designated compressive strength.
2. The tabulated tension and shear values are for the fasteners only. Steel or wood members connected with the substrate must be investigated for compliance with the applicable code.
3. Allowable load capacities are calculated using minimum required factors of safety in accordance with ICC-ES AC70; the minimum applied factor of safety is 5.0. Consideration of additional safety factors may be necessary depending on the application such as life safety.
4. For fasteners installed directly into concrete, the member thickness must be a minimum of three times the embedment but not necessary to be greater than 3.25 inches.
5. Fasteners must have a minimum spacing distance of 4 inches and a minimum edge distance 3-1/2 inches in accordance with ASTM E 1190. Consideration of smaller spacing and edge distances may be given based on application or jobsite testing.
6. For fasteners installed into the upper flute of the steel deck profile, the concrete thickness above the deck (topping thickness) must be a minimum of 3.25 inches. For fasteners installed into the lower flute of the steel deck profile, the concrete thickness above the deck (topping thickness) must be a minimum of 2.25 inches.
7. Fasteners installed into the steel deck profile must have a minimum spacing distance of 4 inches (upper and lower flute) and a minimum edge distance of 1-1/8 inches (lower flute); minimum deck end distance is 3-1/2 inches. Consideration of smaller spacing distances may be given based on application or jobsite testing.
8. Embedment is measured from the surface of the steel deck; the steel deck panel must have a base-metal thickness of 0.030-inch (22 gauge) to 0.060-inch (16 gauge).
9. Multiple fasteners are recommended for any attachment for increased reliability.
10. Fasteners may be installed in 2,500 psi concrete provided the allowable loads are reduced by 11 percent.

**Allowable Load Capacities for CSI Spiral Fasteners in Lightweight Concrete and Sand-Lightweight Concrete over Steel Deck (1-1/2-inch Deep Profile, Inverted Deck Profile Suitable)**<sup>1,2,3,8,9</sup>

Fastener Description	Minimum Embed. Depth in. (mm)	Minimum Concrete Compressive Strength, f 'c = 3,000 psi			
		Directly into Concrete <sup>1,5</sup>		Through Soffit of Steel Deck into Concrete	
		Tension lbs (kN)	Shear lbs (kN)	Upper or Lower Flute <sup>6,7</sup>	
Tension lbs (kN)	Shear lbs (kN)				
CSI Spiral Drive Pin (0.157" Shank)	3/4 (19)	185 (0.8)	270 (1.2)	120 (0.5)	410 (1.8)
	1 (25)	260 (1.2)	375 (1.7)	200 (0.9)	410 (1.8)
	1-1/8 (29)	350 (1.6)	425 (1.9)	200 (0.9)	410 (1.8)
	1-1/4 (32)	350 (1.6)	440 (2.0)	210 (0.9)	415 (1.8)

1. Fasteners must not be driven until the concrete has reached the minimum designated compressive strength.
2. The tabulated tension and shear values are for the fasteners only. Steel or wood members connected with the substrate must be investigated for compliance with the applicable code.
3. Allowable load capacities are calculated using minimum required factors of safety in accordance with ICC-ES AC70; the minimum applied factor of safety is 5.0. Consideration of additional safety factors may be necessary depending on the application such as life safety.
4. For fasteners installed directly into concrete, the member thickness must be a minimum of three times the embedment but not necessary to be greater than 3.25 inches.
5. Fasteners must have a minimum spacing distance of 4 inches and a minimum edge distance 3-1/2 inches in accordance with ASTM E 1190. Consideration of smaller spacing and edge distances may be given based on application or jobsite testing.
6. For fasteners installed into the upper flute of the steel deck profile, or for fasteners installed into the lower flute of the steel deck profile, the concrete thickness above the deck (topping thickness) must be a minimum of 2.25 inches.
7. Fasteners installed into the steel deck profile must have a minimum spacing distance of 4 inches (upper and lower flute) and a minimum edge distance of 7/8 inches (lower flute); minimum deck end distance is 3-1/2 inches. Consideration of smaller spacing distances may be given based on application or jobsite testing.
8. Embedment is measured from the surface of the steel deck; the steel deck panel must have a base-metal thickness of 0.030-inch (22 gauge) to 0.060-inch (16 gauge).
9. Multiple fasteners are recommended for any attachment for increased reliability.

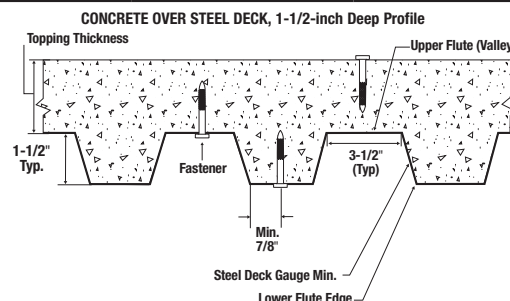
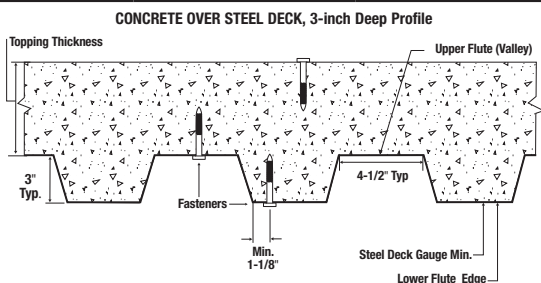

**Allowable Loads for CSI Spiral Fasteners Driven into Concrete Masonry Units**<sup>1,2,3,8,9,10</sup>

Fastener Description	Embed. Depth in. (mm)	Allowable Loads lbs (kN)									
		Hollow CMU <sup>4,7</sup>				Grouted CMU <sup>5,6,7</sup>					
		Face Shell		Horizontal Mortar Joint		Face Shell		Horizontal Mortar Joint		Top and Center of Grouted Wall	
		Tension	Shear	Tension	Shear	Tension	Shear	Tension	Shear	Tension	Shear
CSI Spiral Drive Pin (0.157" Shank)	1 (25)	185 (0.8)	210 (0.9)	70 (0.3)	115 (0.5)	140 (0.6)	165 (0.7)	120 (0.5)	185 (0.8)	120 (0.5)	145 (0.6)

- Fasteners must not be driven until the masonry has reached the minimum designated compressive strength. Concrete masonry must be minimum 8-inch wide, minimum Grade N, Type II, lightweight, medium-weight or normal-weight units conforming to ASTM C90. Mortar must be minimum Type N complying with ASTM C270. Grout must be coarse grout complying with ASTM C476.
- The tabulated tension and shear values are for the fasteners only. Steel or wood members connected with the substrate must be investigated for compliance with the applicable code.
- Allowable load capacities are calculated using minimum required factors of safety in accordance with ICC-ES AC70; the minimum applied factor of safety is 5.0. Consideration of additional safety factors may be necessary depending on the application such as life safety.
- Fasteners installed into the face or end of hollow CMU must have a minimum end distance of 3-3/4 inches. No more than one fastener may be installed in an individual hollow concrete masonry unit cell.
- Fasteners installed into grout-filled concrete masonry must have a minimum spacing distance of 4 inches and a minimum edge and end distance 3-3/4 inches.
- For installations into grout-filled concrete masonry walls, fasteners may be placed into the bed joint (horizontal mortar joint) provided the fasteners have a minimum spacing distance of 8 inches along the bed joint and have a minimum edge distance of 8 inches.
- Installations directly into the head joint (vertical mortar joint) and within 1-1/2 inch of the head joint is not recommended and must not be permitted.
- Allowable shear loads may be applied in any direction.
- Multiple fasteners are recommended for any attachment for increased reliability.
- Successful fastening into the face shell of hollow CMU and into the horizontal mortar joint is typically conducted with the lowest powder load level.

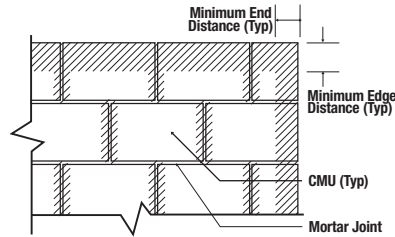

**Wall Face**  
**Permissible Anchor Locations**  
(Un-hatched Area)

**Nominal and Available Pull-Over Strengths for Light Gauge Steel Framing with Power-Driven Fasteners**<sup>1,2,3</sup>

Fastener Description	Shank Diameter	Minimum Thickness of Steel or Framing Member									
		16 Gauge		18 Gauge		20 Gauge		22 Gauge		25 Gauge	
		Nominal (lbs)	Available (lbs)	Nominal (lbs)	Available (lbs)	Nominal (lbs)	Available (lbs)	Nominal (lbs)	Available (lbs)	Nominal (lbs)	Available (lbs)
CSI Spiral Drive Pin	0.157"	1,270	425	1,015	340	765	255	635	210	445	150
CSI Spiral Drive Pin with 1" Washer	0.157"	2,420	805	1,935	645	1,455	485	1,210	405	845	280

- Tabulated pull-over strengths were calculated in accordance with ICC-ES AC70 and AISI S100-16. Allowable load values are based on a safety factor of 3.0.
- Allowable pullover capacities of sheet steel or framing member should be compared to the fastener tensile capacity in concrete, masonry or steel to determine the controlling resistance load.
- Steel or framing member with tensile strength of 45 ksi assumed for calculating tabulated values.

**ORDERING INFORMATION**

**CSI Spiral Drive Pins (8mm Head Diameter)**

Cat. No.	Shank Length	Shank Type	Shank Diameter	Ctn Qty.	Mstr Qty.
50178	1/2"   13mm (K)	Tapered	0.145"	100	1,000
50181	5/8"   16mm (K)	Tapered	0.145"	100	1,000
51201	5/8"   16mm (K)	Straight	0.157"	100	1,000
50203	3/4"   19mm (K)	Straight	0.157"	100	1,000
50204	7/8"   22mm (K)	Straight	0.157"	100	1,000
50205	1"   27mm (K)	Straight	0.157"	100	1,000
50208	1-1/4"   32mm (K)	Straight	0.157"	100	1,000
50207	1-1/2"   37mm (K)	Straight	0.157"	100	1,000
50209	2"   52mm (K)	Straight	0.157"	100	1,000
50241	2-1/2"   62mm (K)	Straight	0.157"	100	1,000
50211	2-7/8"   72mm (K)	Straight	0.157"	100	1,000

(K)- Knurled



**CSI Spiral Drive Pins Collated (8mm Head Diameter)**

Cat. No.	Shank Length	Shank Type	Shank Diameter	Ctn Qty.	Mstr Qty.
50238N	1/2"   13mm (K)	Tapered	0.145"	100	1,000
50241N	5/8"   16mm (K)	Tapered	0.145"	100	1,000
51450	5/8"   16mm (K)	Straight	0.157"	100	1,000
50452	3/4"   19mm (K)	Straight	0.157"	100	1,000
50454	7/8"   22mm (K)	Straight	0.157"	100	1,000
50456	1"   27mm (K)	Straight	0.157"	100	1,000
50458	1-1/4"   32mm (K)	Straight	0.157"	100	1,000
50460	1-1/2"   37mm (K)	Straight	0.157"	100	1,000
50461	1-5/8"   42mm (K)	Straight	0.157"	100	1,000
50462	2"   52mm (K)	Straight	0.157"	100	1,000

(K)- Knurled



**CSI Spiral Drive Pins with Washer (8mm Head Diameter)**

Cat. No.	Shank Length	Shank Type	Shank Diameter	Washer Diameter	Ctn Qty.	Mstr Qty.
50245	3/4"   19mm (K)	Straight	0.157"	3/4"	100	1,000
50247	1"   27mm (K)	Straight	0.157"	3/4"	100	1,000
50261	1-1/4"   32mm (K)	Straight	0.157"	1"	100	1,000
50263	2-1/2"   62mm (K)	Straight	0.157"	1"	100	1,000
50265	2-7/8"   72mm (K)	Straight	0.157"	1"	100	1,000

(K)- Knurled



**POWDER-ACTUATED**

**CSI SPIRAL DRIVE PINS**  
High Performance Domed Head Pins

## GENERAL INFORMATION

# 0.300" HEAD DRIVE PINS

Standard Flat Head Fasteners

### INTRODUCTION

Drive pins with a 0.300" diameter head are designed for permanently fastening a fixture to concrete, concrete over steel deck, concrete masonry walls and A36 or A572 / A992 structural steel. The fasteners are manufactured with a 0.145" diameter shank in various lengths. Knurled shank designs are available for installations in thick steel base materials. A plastic flute is mounted on the pin shank to retain the drive pin in the barrel of the tool and provide guidance during the driving operation. The fasteners are also available in with a mechanically galvanized (MG) coating for use in treated lumber.

### GENERAL APPLICATIONS AND USES

- Attaching light gauge steel to concrete, concrete over steel deck, concrete masonry or steel
- Attaching wood members to concrete, concrete masonry or steel
- Attaching accessories, fixtures and components to concrete, concrete over steel deck, concrete masonry or steel
- Sill plate anchorage

### APPROVALS AND LISTINGS

- International Code Council, Evaluation Service (ICC-ES), ESR-2024
- Code compliant with the International Building Code/International Residential Code: 2018 IBC/IRC, 2015 IBC/IRC, 2012 IBC/IRC, and 2009 IBC/IRC
- Tested in accordance with ASTM E1190 and ICC-ES AC70 for use in concrete, concrete over steel deck, concrete masonry and steel

### GUIDE SPECIFICATION

- CSI Divisions: 03 15 00 - Concrete Accessories, 05 05 23 - Metal Fastenings, 06 05 23 - Wood, Plastic and Composite Fastenings, 09 22 16.23 - Fasteners. Powder-driven fasteners shall be 0.300" head drive pins as supplied by DEWALT, Towson, MD. Fasteners shall be installed in accordance with published instructions and the Authority Having Jurisdiction.

## SELECTION GUIDE

Pin / Fastener Description	Dimensions		Base Material				DEWALT Tools						Approvals & Listings	
	Shank Diameter	Shank Length	Concrete	Lightweight Concrete	Concrete over Steel Deck	Concrete Masonry (CMU)	Steel	P1000 / T1000	P2201	P35s	P3500 / PA3500	Shiper		DFDZ70
0.300" Head Pin (including MG pins)	0.145"	1/2" to 1-1/2"	●	●	●	●	●	●	●	●	●	●	●	ICC-ES ESR-2024
	0.145"	2" to 3"	●	●	●	○	○	●	●	●	●	●	●	ICC-ES ESR-2024
0.300" Head Pin with Top Hat	0.145"	1/2" to 1"	●	●	●	●	●	●	●	●	●	●	●	ICC-ES ESR-2024
0.300" Head Pin with Washer (including MG pins)	0.145"	3/4" to 1-1/2"	●	●	●	●	●	●	●	●	●	●	●	ICC-ES ESR-2024
	0.145"	2" to 3"	●	●	●	○	○	●	●	●	●	●	●	ICC-ES ESR-2024
0.300" Head Ballistic Point Pin	0.181/0.150"	1-7/8"	●	●	●	○	○	●	●	●	●	●	●	ICC-ES ESR-2024

● Suitable ○ May be Suitable  
MG = Mechanical Galvanized

## SECTION CONTENTS

General Information..... 18  
 Selection Guide..... 18  
 Performance Data..... 19  
 Ordering Information..... 21

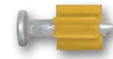

0.300" HEAD DRIVE PIN



0.300" HEAD DRIVE PIN WITH TOP HAT



0.300" HEAD DRIVE PIN WITH WASHER



0.300" HEAD DRIVE PIN MECHANICALLY GALVANIZED



0.300" HEAD BALLISTIC POINT DRIVE PIN

## SUITABLE BASE MATERIALS

- Normal-weight concrete
- Lightweight concrete
- Concrete over steel deck
- Grouted concrete masonry (CMU)
- Hollow concrete masonry (CMU)
- Steel

## FASTENER SIZE RANGE

- 1/2" length through 3" length

**CODE LISTED**  
 ICC-ES ESR-2024  
 CONCRETE, MASONRY, STEEL

**PERFORMANCE DATA**

**Allowable Load Capacities for Powder-Actuated Fasteners in Normal-Weight Concrete**<sup>1,2,3,4,5,6</sup>

Fastener Description	Minimum Embed. Depth in. (mm)	Minimum Concrete Compressive Strength (f'c)							
		2,000psi		2,500psi		3,000psi		4,000psi	
		Tension lbs. (kN)	Shear lbs. (kN)	Tension lbs. (kN)	Shear lbs. (kN)	Tension lbs. (kN)	Shear lbs. (kN)	Tension lbs. (kN)	Shear lbs. (kN)
0.300" Head Drive Pin (0.145" Shank)	5/8 (15.9)	25 (0.1)	45 (0.2)	80 (0.4)	150 (0.7)	85 (0.4)	150 (0.7)	85 (0.4)	150 (0.7)
	3/4 (19.1)	60 (0.3)	95 (0.4)	85 (0.4)	195 (0.9)	90 (0.4)	195 (0.9)	90 (0.4)	195 (0.9)
	1 (25.4)	100 (0.4)	140 (0.6)	145 (0.6)	400 (1.8)	145 (0.6)	400 (1.8)	145 (0.6)	400 (1.8)
	1-1/4 (31.8)	110 (0.5)	155 (0.7)	305 (1.4)	495 (2.2)	305 (1.4)	495 (2.2)	305 (1.4)	495 (2.2)
	1-1/2 (38.1)	115 (0.5)	175 (0.8)	305 (1.4)	495 (2.2)	465 (2.1)	505 (2.2)	465 (2.1)	505 (2.2)

1. Fasteners must not be driven until the concrete has reached the minimum designated compressive strength. Linear interpolation may be used to determine allowable loads for intermediate compressive strengths.
2. The tabulated tension and shear values are for the fasteners only. Steel or wood members connected with the substrate must be investigated for compliance with the applicable code.
3. Allowable load capacities are calculated using minimum required factors of safety in accordance with ICC-ES AC70; the minimum applied factor of safety is 5.0. Consideration of additional safety factors may be necessary depending on the application such as life safety.
4. Concrete member thickness must be a minimum of three times the fastener embedment depth.
5. Fasteners must have a minimum spacing distance of 3 inches and a minimum edge distance of 3-1/4 inches in accordance with ASTM E 1190. Consideration of smaller spacing and edge distances may be given based on application or jobsite testing.
6. Multiple fasteners are recommended for any attachment for increased reliability.

**Allowable Load Capacities for Powder-Actuated Fasteners in Lightweight Concrete and Lightweight Concrete over Steel Deck**<sup>1,2,3,8</sup>

Fastener Description	Minimum Embed. Depth in. (mm)	Minimum Concrete Compressive Strength, f'c = 3,000 psi					
		Directly into Concrete <sup>4,5</sup>		Through Soffit of Steel Deck into Concrete (3-inch Deep Profile)			
		Tension	Shear	Upper Flute <sup>6,7</sup>		Lower Flute <sup>6,7</sup>	
				Allowable lbs (kN)	Allowable lbs (kN)	Allowable lbs (kN)	Allowable lbs (kN)
0.300" Head Drive Pin (0.145" Shank)	3/4 (19)	70 (0.3)	70 (0.3)	165 (0.7)	280 (1.3)	95 (0.4)	290 (1.3)
	7/8 (22)	135 (0.6)	145 (0.6)	165 (0.7)	280 (1.3)	165 (0.7)	290 (1.3)
	1 (25)	200 (0.9)	215 (1.0)	175 (0.8)	290 (1.3)	165 (0.7)	290 (1.3)
	1-1/4 (32)	250 (1.1)	305 (1.4)	280 (1.2)	340 (1.5)	190 (0.8)	340 (1.5)
	1-1/2 (38)	340 (1.5)	375 (1.7)	280 (1.2)	380 (1.7)	235 (1.0)	380 (1.7)

1. Fasteners must not be driven until the concrete has reached the minimum designated compressive strength. For a concrete compressive strength of 4,000 psi, the tabulated allowable loads may be increased by 12 percent. Fasteners may also be installed in 2,500 psi concrete provided the allowable loads are reduced by 11 percent.
2. The tabulated tension and shear values are for the fasteners only. Steel or wood members connected with the substrate must be investigated for compliance with the applicable code.
3. Allowable load capacities are calculated using minimum required factors of safety in accordance with ICC-ES AC70; the minimum applied factor of safety is 5.0. Consideration of additional safety factors may be necessary depending on the application such as life safety.
4. For fasteners installed directly into concrete, the member thickness must be a minimum of three times the embedment but not necessary to be greater than 3.25 inches. Tabulated values are also applicable to the tops of concrete-filled steel deck profiles.
5. Fasteners must have a minimum spacing distance of 3 inches and a minimum edge distance 3 inches in accordance with ASTM E 1190. Consideration of smaller spacing and edge distances may be given based on application or jobsite testing.
6. For fasteners installed into the upper flute of the steel deck profile, the concrete thickness above the deck (topping thickness) must be a minimum of 3.25 inches. For fasteners installed into the lower flute of the steel deck profile, the concrete thickness above the deck (topping thickness) must be a minimum of 2.25 inches.
7. Fasteners installed into the steel deck profile must have a minimum spacing distance of 4 inches (upper and lower flute) and a minimum edge distance of 1-1/8 inches (lower flute); minimum deck end distance is 3-1/2 inches. Consideration of smaller spacing distances may be given based on application or jobsite testing.
8. Embedment is measured from the surface of the steel deck; the steel deck panel must have a base-metal thickness of 0.030-inch (22 gauge) to 0.048-inch (18 gauge). Consideration for the thickness of the material fastened to the base material must be given to achieve the required embedment for the fasteners.
9. Multiple fasteners are recommended for any attachment for increased reliability.

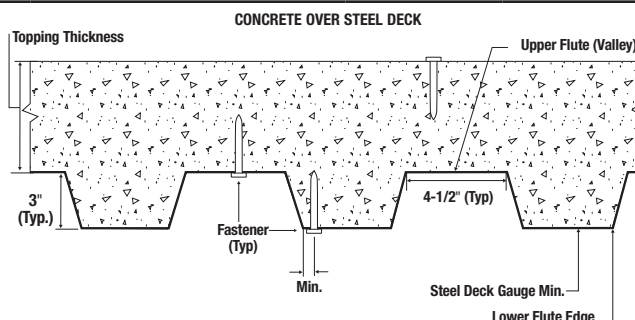

### Allowable Load Capacities for Powder-Actuated Fasteners used to Install Wood Sill Plates into Normal-Weight Concrete<sup>1,2,3,4,5,6,7,8,9,10</sup>

Fastener Description	Minimum Embedment Depth in. (mm)	Minimum Concrete Compressive Strength, f'c = 2,000 psi		
		Tension	Load Perpendicular to Edge	Load Parallel to Edge
			Shear	Shear
Allowable lbs. (kN)	Allowable lbs. (kN)	Allowable lbs. (kN)	Allowable lbs. (kN)	
0.300" Head Drive Pin (0.145" Shank)	1-1/2 (38)	125 (0.6)	150 (0.7)	230 (1.0)

1. Fasteners must not be driven until the concrete has reached the minimum designated compressive strength.
2. The tabulated tension and shear values are for the fasteners only. Wood members connected with the substrate must be investigated for compliance with the applicable code.
3. Allowable load capacities are calculated using minimum required factors of safety in accordance with ICC-ES AC70; the minimum applied factor of safety is 5.0. Consideration of additional safety factors may be necessary depending on the application such as life safety.
4. Concrete member thickness must be a minimum of three times the fastener embedment depth.
5. Fasteners must have a minimum spacing distance of 4 inches and a minimum edge distance of 1-3/4 inches.
6. Minimum nominal washer size is 7/8 inch; minimum washer bearing area is 0.55 inch<sup>2</sup>. Washers may be round or square.
7. Fastener bending yield strength (F<sub>y</sub>) is 90,000 psi and dowel bearing strength (F<sub>d</sub>) is 7,500 psi.
8. For interior nonstructural walls, fasteners must be placed at 6 inches from ends of the sill plates with a maximum fastener spacing of 3 feet which is applicable to a maximum wall height of 14 feet in accordance with ICC-ES AC70. Interior nonstructural walls are limited to locations where bearing walls, shear walls or braced walls are not required by the approved plans. Other attachments including perimeter anchorage must be investigated for compliance with the applicable code using the tabulated and noted information.
9. Mechanically Galvanized (MG) fasteners can be considered for use with preservative treated lumber.
10. Multiple fasteners are recommended for any attachment for increased reliability.

### Allowable Load Capacities for Powder-Actuated Fasteners in Concrete Masonry (CMU)<sup>1,2,3,9,10,11</sup>

Fastener Description	Min. Embed. Depth in. (mm)	Minimum Masonry Compressive Strength, f'c = 1,500 psi							
		Hollow CMU <sup>4,5</sup>				Grout-filled Concrete Masonry <sup>6,7,8</sup>			
		Cell Face		Cell Face		Mortar Joint		Top of Grouted Wall	
		Tension	Shear	Tension	Shear	Tension	Shear	Tension	Shear
Allowable lbs (kN)	Allowable lbs (kN)	Allowable lbs (kN)	Allowable lbs (kN)	Allowable lbs (kN)	Allowable lbs (kN)	Allowable lbs (kN)	Allowable lbs (kN)	Allowable lbs (kN)	
0.300" Head Drive Pin (0.145" Shank)	1 (25)	35 (0.2)	95 (0.4)	150 (0.7)	155 (0.7)	140 (0.6)	170 (0.8)	45 (0.3)	115 (0.5)

1. Fasteners must not be driven until the masonry has reached the minimum designated compressive strength. Concrete masonry must be minimum 8-inch wide, minimum Grade N, Type II, lightweight, medium-weight or normal-weight units conforming to ASTM C90. Mortar must be minimum Type N complying with ASTM C270. Grout must be coarse grout complying with ASTM C476.
2. The tabulated tension and shear values are for the fasteners only. Steel or wood members connected with the substrate must be investigated for compliance with the applicable code.
3. Allowable load capacities are calculated using minimum required factors of safety in accordance with ICC-ES AC70; the minimum applied factor of safety is 5.0. Consideration of additional safety factors may be necessary depending on the application such as life safety.
4. Fasteners installed into the face or end of hollow CMU must have a minimum end distance of 3-3/4 inches. No more than one fastener may be installed in an individual hollow concrete masonry unit cell.
5. For installations into hollow CMU walls, fasteners may not be placed into the mortar joint.
6. Fasteners installed into grout-filled concrete masonry must have a minimum spacing distance of 4 inches and a minimum edge distance 3-3/4 inches.
7. For installations into grout-filled concrete masonry walls, fasteners may be placed into the bed joint (horizontal mortar joint) provided the fasteners have a minimum spacing distance of 8 inches along the bed joint and have a minimum edge distance of 8 inches.
8. Installations directly into the head joint (vertical mortar joint) and within 1-1/2 inch of the head joint is not recommended and must not be permitted.
9. Allowable shear loads may be applied in any direction.
10. Multiple fasteners are recommended for any attachment for increased reliability.
11. Successful fastening into the face shell of hollow CMU and into the horizontal mortar joint is typically conducted with the lowest powder load level.

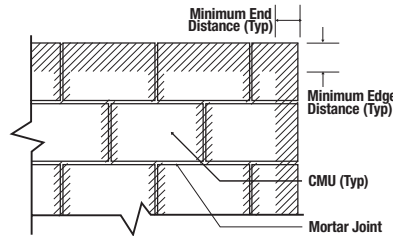

**Wall Face Permissible Anchor Locations (Un-hatched Area)**

**Allowable Load Capacities for Powder-Actuated Fasteners in ASTM A36 Steel<sup>1,2,3,5,6</sup>**

Fastener Description	Nominal Steel Thickness (inch)									
	1/8		3/16		1/4		3/8		1/2 <sup>(6)</sup>	
	Tension lbs. (kN)	Shear lbs. (kN)	Tension lbs. (kN)	Shear lbs. (kN)	Tension lbs. (kN)	Shear lbs. (kN)	Tension lbs. (kN)	Shear lbs. (kN)	Tension lbs. (kN)	Shear lbs. (kN)
0.300" Head Drive Pin (0.145" Knurled Shank)	220 (1.0)	200 (0.9)	340 (1.5)	610 (2.7)	445 (2.0)	560 (2.5)	520 (2.3)	605 (2.7)	490 (2.2)	575 (2.6)
0.300" Head Drive Pin (0.145" Smooth Shank)	170 (0.8)	265 (1.2)	355 (1.6)	565 (2.5)	410 (1.8)	560 (2.5)	465 (2.1)	390 (1.7)	390 (1.7)	520 (2.3)

- Fastener capacities are based on the base steel with a minimum yield strength (F<sub>y</sub>) of 36 ksi and a minimum ultimate tensile strength (F<sub>u</sub>) of 58 ksi. The pointed portion of the fastener must penetrate the steel member unless otherwise noted.
- The tabulated tension and shear values are for the fasteners only. Steel or wood members connected to the steel substrate must be investigated for compliance with the applicable code.
- Allowable load capacities are calculated using minimum required factors of safety in accordance with ICC-ES AC70; the minimum applied factor of safety is 5.0. Consideration of additional safety factors may be necessary depending on the application such as life safety.
- The fasteners must be embedded a minimum of 0.50 inch into the steel; fastener point penetration through the steel is not necessary provided the minimum embedment is achieved.
- Fasteners must have a minimum spacing distance of 1-1/2 inches and a minimum edge distance of 1/2 inch in accordance with ASTM E 1190. Consideration of smaller spacing distances may be given based on application or jobsite testing.
- Multiple fasteners are recommended for any attachment for increased reliability.

**Nominal and Available Pull-Over Strengths for Light Gauge Steel Framing with Power-Driven Fasteners<sup>1,2,3</sup>**

Fastener Description	Shank Diameter	Minimum Thickness of Steel or Framing Member									
		16 Gauge		18 Gauge		20 Gauge		22 Gauge		25 Gauge	
		Nominal (lbs)	Available (lbs)	Nominal (lbs)	Available (lbs)	Nominal (lbs)	Available (lbs)	Nominal (lbs)	Available (lbs)	Nominal (lbs)	Available (lbs)
0.300" Head Drive Pin with 7/8" or 1" washer	0.145"	3,120	1,040	2,495	830	1,875	625	1,560	520	1,090	365
0.300" Head Drive Pin	0.145"	1,560	520	1,250	415	935	310	780	260	545	180

- Tabulated pull-over strengths were calculated in accordance with ICC-ES AC70 and AISI S100-16. Allowable load values are based on a safety factor of 3.0.
- Allowable pullover capacities of sheet steel or framing member should be compared to the fastener tensile capacity in concrete, masonry or steel to determine the controlling resistance load.
- Steel or framing member with tensile strength of 58 ksi assumed for calculating tabulated values.

**ORDERING INFORMATION**

**0.300" Diameter Head Drive Pins**

Cat. No.	Shank Length	Shank Diameter	Ctn Qty	Mstr Qty
50012	1/2" (K)	0.145"	100	5,000
50016	5/8" (K)	0.145"	100	5,000
50022	3/4"	0.145"	100	5,000
50023	3/4" (black)	0.145"	100	5,000
50026	1"	0.145"	100	5,000
50032	1-1/4"	0.145"	100	1,000
50034	1-1/2"	0.145"	100	1,000
50038	2"	0.145"	100	1,000
50040	2-1/4"	0.145"	100	1,000
50044	2-1/2"	0.145"	100	1,000
50048	3"	0.145"	100	1,000

(K) = knurled  
Black pins have a black coating instead of zinc plating.

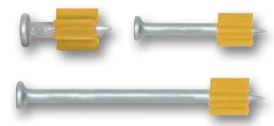

**0.300" Diameter Head Drive Pins with Top Hat**

Cat. No.	Shank Length	Shank Diameter	Ctn Qty	Mstr Qty
50136	1/2" (K)	0.145"	100	5,000
50138	5/8" (K)	0.145"	100	5,000
50140	3/4"	0.145"	100	5,000
50144	1"	0.145"	100	5,000

(K) = knurled



**0.300" Diameter Head Drive Pins with 3/4" Washer**

Cat. No.	Shank Length	Shank Diameter	Ctn Qty	Mstr Qty
50070	3/4"	0.145"	100	1,000



**0.300" Diameter Head Drive Pins with 7/8" Washer**

Cat. No.	Shank Length	Shank Diameter	Ctn Qty	Mstr Qty
50090	1"	0.145"	100	1,000
50092	1-1/4"	0.145"	100	1,000
50094	1-1/2"	0.145"	100	1,000
50096	2"	0.145"	100	1,000
50098	2-1/2"	0.145"	100	1,000
50100	3"	0.145"	100	1,000



**0.300" Diameter Head Drive Pins with 1" Washer**

Cat. No.	Shank Length	Shank Diameter	Ctn Qty	Mstr Qty
50108	1-1/4"	0.145"	100	1,000
50110	1-1/2"	0.145"	100	1,000
50112	2"	0.145"	100	1,000
50114	2-1/4"	0.145"	100	1,000
50116	3"	0.145"	100	1,000
50120*	3"	0.145"	100	1,000

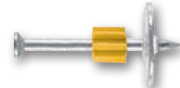

\*Square Washer

**0.300" Diameter Head Drive Pins (Mechanically Galvanized)**

Cat. No.	Shank Length	Shank Dia.	Ctn Qty	Mstr Qty
50034MG	1-1/2"	0.145"	1,000	5,000
50038MG	2"	0.145"	1,000	5,000
50045MG	2-1/2"	0.145"	1,000	5,000
50047MG	3"	0.145"	1,000	5,000



Mechanically Galvanized (MG) fasteners meet ASTM B695, Class 55. Fasteners are designed for fastening through pressure treated lumber. The fasteners are available with a round washer for increased pullover resistance.

**0.300" Diameter Head Drive Pins with 1" Washer (Mechanically Galvanized)**

Cat. No.	Shank Length	Shank Dia.	Ctn Qty	Mstr Qty
50110MG	1-1/2"	0.145"	1,000	5,000
50112MG	2"	0.145"	1,000	5,000
50113MG	2-1/2"	0.145"	1,000	5,000
50115MG	3"	0.145"	1,000	5,000



Mechanically Galvanized (MG) fasteners meet ASTM B695, Class 55. Fasteners are designed for fastening through pressure treated lumber. The fasteners are available with a round washer for increased pullover resistance.

**0.300" Diameter Head Drive Pins with 1-7/8" Insulation Washer**

Cat. No.	Shank Length	Shank Dia.	Ctn Qty	Mstr Qty
50122	1-1/2"	0.145"	100	1,000
50126	2-1/2"	0.145"	100	1,000



**0.300" Diameter Head Ballistic Point Drive Pins**

Cat. No.	Shank Length	Shank Dia.	Ctn Qty	Mstr Qty
50057	1-7/8"	0.181/0.150"	100	1,000



Ballistic point pins have a black coating instead of zinc plating.



**GENERAL INFORMATION**

**8MM HEAD DRIVE PINS**

Standard Domed Head Fasteners

**PRODUCT DESCRIPTION**

Drive pins with an 8mm diameter head are designed for permanently fastening a fixture to concrete, concrete over steel deck, and A36 or A572 / A992 structural steel. The fasteners are manufactured with a 0.145" diameter shank in various lengths. Knurled shank designs are available for installations in thick steel base materials. For single fasteners, a plastic washer is mounted on the pin shank to retain the drive pin in the barrel of the tool and provide centered guidance during the driving operation.

**GENERAL APPLICATIONS AND USES**

- Attaching light gauge steel to concrete, concrete over steel deck or steel
- Attaching wood members to concrete or steel
- Attaching accessories, fixtures and components to concrete, concrete over steel deck or steel
- Sill plate anchorage

**APPROVALS AND LISTINGS**

- International Code Council, Evaluation Service (ICC-ES), ESR-2024
- Code compliant with the International Building Code/International Residential Code: 2018 IBC/IRC, 2015 IBC/IRC, 2012 IBC/IRC, and 2009 IBC/IRC
- Tested in accordance with ASTM E1190 and ICC-ES AC70 for attachments in concrete and steel

**GUIDE SPECIFICATION**

- CSI Divisions: 03 15 00 - Concrete Accessories, 05 05 23 - Metal Fastenings, 06 05 23 - Wood, Plastic and Composite Fastenings, 09 22 16.23 - Fasteners.
- Powder-driven fasteners shall be 8mm head drive pins as supplied by DEWALT, Towson, MD. Fasteners shall be installed in accordance with published instructions and the Authority Having Jurisdiction.

**SELECTION GUIDE**

Pin / Fastener Description	Dimensions		Base Material				DEWALT Tools						Approvals & Listings
	Shank Diameter	Shank Length	Concrete	Lightweight Concrete	Concrete over Steel Deck	Steel	P1000 / T1000	P2201	P35s	P3500 / PA3500	Sniper	DFDZ70	
8mm Head Pin with Top Hat	0.145"	16mm to 27mm (5/8" to 1")	●	●	●	●	●	●	●	●	●	●	ICC-ES ESR-2024
8mm Head Pin with Washer	0.145"	27mm to 37mm (1" to 1-1/2")	●	●	●	●	●	●	●	●	●	●	ICC-ES ESR-2024
	0.145"	42mm to 72mm (1-5/8" to 2-7/8")	●	●	●	○	●	●	●	●	●	●	ICC-ES ESR-2024

● Suitable    ○ May be Suitable

**SECTION CONTENTS**

General Information.....23  
 Selection Guide.....23  
 Performance Data.....24  
 Ordering Information.....25



8MM HEAD DRIVE PIN WITH TOP HAT



8MM HEAD DRIVE PINS WITH 1" WASHER

**SUITABLE BASE MATERIALS**

- Normal-weight concrete
- Lightweight concrete
- Concrete over steel deck
- Steel

**FASTENER SIZE RANGE**

- 16mm (5/8") length through 72mm (2-7/8") length

**CODE LISTED**  
ICC-ES ESR-2024  
CONCRETE, STEEL

**POWDER-ACTUATED**

**8MM HEAD DRIVE PINS**  
Standard Domed Head Fasteners

**PERFORMANCE DATA**

**Allowable Load Capacities for Powder-Actuated Fasteners in Normal-Weight Concrete**<sup>1,2,3,4,5,6</sup>

Fastener Description	Minimum Embed. Depth in. (mm)	Minimum Concrete Compressive Strength (f'c)							
		2,000 psi		3,000 psi		4,000 psi		5,000 psi	
		Tension lbs. (kN)	Shear lbs. (kN)	Tension lbs. (kN)	Shear lbs. (kN)	Tension lbs. (kN)	Shear lbs. (kN)	Tension lbs. (kN)	Shear lbs. (kN)
8mm Head Drive Pin (0.145" Shank)	5/8 (15.9)	25 (0.1)	45 (0.2)	60 (0.3)	95 (0.4)	45 (0.2)	95 (0.4)	25 (0.1)	95 (0.4)
	3/4 (19.1)	60 (0.3)	95 (0.4)	95 (0.4)	125 (0.6)	95 (0.4)	125 (0.6)	100 (0.4)	125 (0.6)
	1 (25.4)	100 (0.4)	140 (0.6)	130 (0.6)	155 (0.7)	155 (0.7)	155 (0.7)	180 (0.8)	200 (0.9)
	1-1/4 (31.8)	110 (0.5)	155 (0.7)	155 (0.7)	165 (0.7)	195 (0.9)	165 (0.7)	235 (1)	200 (0.9)
	1-1/2 (38.1)	115 (0.5)	175 (0.8)	180 (0.8)	175 (0.8)	235 (1)	175 (0.8)	290 (1.3)	200 (0.9)

1. Fasteners must not be driven until the concrete has reached the minimum designated compressive strength. Linear interpolation may be used to determine allowable loads for intermediate compressive strengths.
2. Concrete thickness must be a minimum of three times the embedment depth.
3. The allowable tension and shear values are for fasteners only. Steel or wood members connected to the substrate must be investigated for compliance with the applicable code.
4. Allowable load capacities are calculated using minimum required factors of safety in accordance with ICC-ES AC70; the minimum applied factor of safety is 5.0. Consideration of additional safety factors may be necessary depending on the application such as life safety.
5. Fasteners must have a minimum spacing distance of 3 inches and a minimum edge distance 3 inches in accordance with ASTM E 1190. Consideration of smaller spacing and edge distances may be given based on application or jobsite testing.
6. Multiple fasteners are recommended for any attachment for increased reliability.

**Allowable Load Capacities for Powder-Actuated Fasteners in Lightweight Concrete and Sand-Lightweight Concrete over Steel Deck**<sup>1,2,3,8,9</sup>

Fastener Description	Minimum Embed. Depth in. (mm)	Minimum Concrete Compressive Strength, f'c = 3,000 psi					
		Directly into Concrete <sup>4,5</sup>		Through Soffit of Steel Deck into Concrete (3-inch Deep Profile) <sup>7,8</sup>			
		Tension	Shear	Upper Flute		Lower Flute	
		Allowable lbs. (kN)	Allowable lbs. (kN)	Allowable lbs. (kN)	Allowable lbs. (kN)	Allowable lbs. (kN)	Allowable lbs. (kN)
8mm Head Drive Pin (0.145" Shank)	3/4 (19)	70 (0.3)	70 (0.3)	-	-	-	-
	1 (25)	70 (0.3)	125 (0.6)	175 (0.8)	290 (1.3)	120 (0.5)	290 (1.3)
	1-1/4 (32)	130 (0.6)	180 (0.8)	220 (1.0)	340 (1.5)	190 (0.8)	340 (1.5)
	1-1/2 (38)	130 (0.6)	180 (0.8)	235 (1.0)	380 (1.7)	235 (1.0)	380 (1.7)

1. Fasteners must not be driven until the concrete has reached the minimum designated compressive strength. For a concrete compressive strength of 4,000 psi, the tabulated allowable loads may be increased by 12 percent.
2. The tabulated tension and shear values are for the fasteners only. Steel or wood members connected with the substrate must be investigated for compliance with the applicable code.
3. Allowable load capacities are calculated using minimum required factors of safety in accordance with ICC-ES AC70; the minimum applied factor of safety is 5.0. Consideration of additional safety factors may be necessary depending on the application such as life safety.
4. For fasteners installed directly into concrete, the member thickness must be a minimum of three times the embedment but not necessary to be greater than 3.25 inches. Tabulated values are also applicable to the tops of concrete-filled steel deck profiles.
5. Fasteners must have a minimum spacing distance of 3 inches and a minimum edge distance 3 inches in accordance with ASTM E 1190. Consideration of smaller spacing and edge distances may be given based on application or jobsite testing.
6. For fasteners installed into the upper flute of the steel deck profile, the concrete thickness above the deck (topping thickness) must be a minimum of 3.25 inches. For fasteners installed into the lower flute of the steel deck profile, the concrete thickness above the deck (topping thickness) must be a minimum of 2.25 inches.
7. Fasteners installed into the steel deck profile must have a minimum spacing distance of 4 inches (upper and lower flute) and a minimum edge distance of 1-1/8 inches (lower flute); there is no minimum edge distance requirement for fasteners installed in the upper flute. Consideration of smaller spacing distances may be given based on application or jobsite testing.
8. Embedment is measured from the surface of the steel deck; the steel deck panel must have a base-metal thickness of 0.030-inch (22 gauge) to 0.048-inch (18 gauge). Consideration for the thickness of the material fastened to the base material must be given to achieve the required embedment for the fasteners.
9. Multiple fasteners are recommended for any attachment for increased reliability.

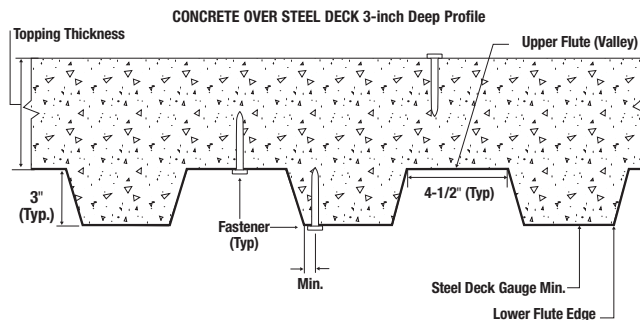

**Allowable Load Capacities for Powder-Actuated Fasteners in ASTM A36 Steel<sup>1,2,3,5,6</sup>**

Fastener Description	Shank Type	Nominal Steel Thickness									
		1/8"		3/16"		1/4"		3/8"		1/2" <sup>(4)</sup>	
		Tension lbs. (kN)	Shear lbs. (kN)	Tension lbs. (kN)	Shear lbs. (kN)	Tension lbs. (kN)	Shear lbs. (kN)	Tension lbs. (kN)	Shear lbs. (kN)	Tension lbs. (kN)	Shear lbs. (kN)
8mm Head Drive Pin (0.145" Shank)	Knurled	220 (1.0)	200 (0.9)	340 (1.5)	610 (2.7)	445 (2.0)	560 (2.5)	520 (2.3)	605 (2.7)	490 (2.2)	575 (2.6)
	Smooth	170 (0.8)	265 (1.2)	355 (1.6)	565 (2.5)	410 (1.8)	560 (2.5)	465 (2.1)	390 (1.7)	390 (1.7)	520 (2.3)

- The allowable tension and shear values are for fasteners only. Steel or wood members connected to the substrate must be investigated for compliance with the applicable code.
- Allowable load capacities are calculated using minimum required factors of safety in accordance with ICC-ES AC70; the minimum applied factor of safety is 5.0. Consideration of additional safety factors may be necessary depending on the application such as life safety.
- Fasteners must be driven to obtain an embedment equivalent to the nominal steel thickness with the point of the fastener penetrating through the steel base material.
- Fasteners must be driven to obtain a minimum embedment of 0.50 inch into steel. The point of the fastener does not need to penetrate through the steel base material.
- Fasteners must have a minimum spacing distance of 1-1/2 inches and a minimum edge distance of 1/2 inch in accordance with ASTM E 1190. Consideration of smaller spacing distances may be given based on application or jobsite testing.
- Multiple fasteners are recommended for any attachment for increased reliability.

**Nominal and Available Pull-Over Strengths for Light Gauge Steel Framing with Powder-Actuated Fasteners<sup>1,2,3</sup>**

Fastener Description	Shank Diameter	Minimum Thickness of Steel or Framing Member									
		16 Gauge		18 Gauge		20 Gauge		22 Gauge		25 Gauge	
		Nominal (lbs)	Available (lbs)	Nominal (lbs)	Available (lbs)	Nominal (lbs)	Available (lbs)	Nominal (lbs)	Available (lbs)	Nominal (lbs)	Available (lbs)
8mm Top Hat Pin	0.145"	2,185	730	1,745	580	1,310	435	1,095	365	765	255
8mm Pin with 1" Washer	0.145"	3,120	1,040	2,495	830	1,875	625	1,560	520	1,090	365

- Tabulated pull-over strengths were calculated in accordance with ICC-ES AC70 and AISI S100-16. Allowable load values are based on a safety factor of 3.0.
- Allowable pullover capacities of sheet steel or framing member should be compared to the fastener tensile capacity in concrete, masonry or steel to determine the controlling resistance load.
- Steel or framing member with tensile strength of 58 ksi assumed for calculating tabulated values.

**ORDERING INFORMATION**

**8mm Diameter Head Drive Pins with Top Hat**

Cat. No.	Shank Length	Shank Diameter	Ctn Qty	Mstr Qty
50210	16mm   5/8" (K)	0.145"	100	5,000
50214	22mm   7/8"	0.145"	100	5,000
50216	27mm   1"	0.145"	100	5,000

(K) = knurled

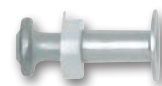

**8mm Diameter Head Drive Pins with 1" Washer**

Cat. No.	Shank Length	Shank Diameter	Ctn Qty	Mstr Qty
50220	27mm   1"	0.145"	100	1,000
50222	32mm   1-1/4"	0.145"	100	1,000
50224	37mm   1-1/2"	0.145"	100	1,000
50226	52mm   2"	0.145"	100	1,000
50228	62mm   2-1/2"	0.145"	100	1,000
50230	72mm   2-7/8"	0.145"	100	1,000
50229	72mm   2-7/8" (MG)	0.145"	100	1,000

MG = Mechanically Galvanized. MG fasteners meet ASTM B695, Class 55 and are designed for fastening through pressure treated lumber.

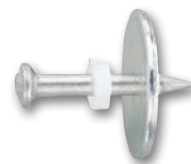

**GENERAL INFORMATION**

**CEILING CLIP ASSEMBLIES**

**PRODUCT DESCRIPTION**

Ceiling Clips are used for acoustical applications, suspended ceiling systems, fixtures and wire components to concrete, concrete-filled steel deck and steel. Several styles and types of angled clips with pre-mounted pins are available. A ceiling clip without a premounted pin is also offered.

**GENERAL APPLICATIONS AND USES**

- Attaching ceiling wire, pencil rod and components to concrete, concrete over steel deck or steel

**APPROVALS AND LISTINGS**

- International Code Council, Evaluation Service (ICC-ES), ESR-2024
- Code compliant with the International Building Code/International Residential Code: 2018 IBC/IRC, 2015 IBC/IRC, 2012 IBC/IRC, and 2009 IBC/IRC
- Tested in accordance with ASTM E1190 and ICC-ES AC70 for use in concrete, concrete over steel deck and steel

**GUIDE SPECIFICATION**

- CSI Divisions: 03 15 00 - Concrete Accessories, 05 05 23 - Metal Fastenings, 09 22 16.23 - Fasteners. Powder-driven fasteners shall be ceiling clip assemblies as supplied by DEWALT, Towson, MD. Fasteners shall be installed in accordance with published instructions and the Authority Having Jurisdiction.

**SELECTION GUIDE**

Pin / Fastener Description	Dimensions		Base Material				DEWALT Tools						Approvals & Listings
	Shank Diameter	Shank Length	Concrete	Lightweight Concrete	Concrete Over Steel Deck	Steel	P1000 / T1000	P2201	P35s	P3500 / PA3500	Striper	DFD270	
CSI Spiral Ceiling Clip (8mm Head Pin)	0.157"	22mm to 32mm (7/8" to 1-1/4")	•	•	•	•			•	•	•	•	ICC-ES ESR-2024
Standard and Extended Length Ceiling Clips (0.300" & 8mm Head Pins)	0.145"	7/8" to 1-1/4" (22mm to 32mm)	•	•	•	•		○	•	•	•	•	ICC-ES ESR-2024
Economy Ceiling Clip (0.300" Head Pin)	0.145"	7/8" to 1-1/4"	•	•	•	•		○	•	•	•	•	ICC-ES ESR-2024
Ballistic Ceiling Clip (0.300" Head Pin)	0.150"	7/8"	•	•	•	•		○	•	•	•	•	ICC-ES ESR-2024
	0.181/0.150"	1-1/4"	•	•	•	•			•	•	•	•	

• Suitable    ○ May be Suitable

**SECTION CONTENTS**

General Information.....26  
 Selection Guide.....26  
 Performance Data.....27  
 Ordering Information.....30



CSI SPIRAL DRIVE PIN WITH CEILING CLIP

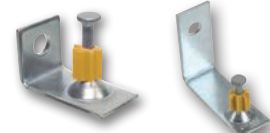

0.300" HEAD DRIVE PINS WITH CEILING CLIPS - STANDARD AND EXTENDED LENGTH (XL)

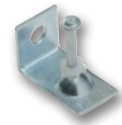

8MM HEAD DRIVE PINS WITH CEILING CLIPS

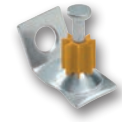

0.300" HEAD DRIVE PINS WITH ECONOMY CLIPS

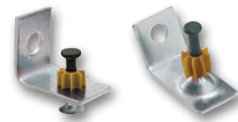

BALLISTIC POINT DRIVE PINS WITH CEILING CLIPS



CEILING CLIP WITHOUT PIN

**SUITABLE BASE MATERIALS**

- Normal-weight concrete
- Lightweight concrete
- Concrete over steel deck
- Steel

**FASTENER SIZE RANGE**

- 7/8" length through 1-1/4" length

**CODE LISTED**  
 ICC-ES ESR-2024  
 CONCRETE, STEEL

**PERFORMANCE DATA**

**Allowable Load Capacities for Ceiling Clips in Normal-Weight Concrete**<sup>1,2,3,4,5,6,7</sup>

Fastener Description	Min. Embed. Depth in. (mm)	Minimum Concrete Compressive Strength, f 'c							
		2,000 psi		3,000 psi			4,000 psi		
		Tension	Shear	Tension	Shear	45-Degree	Tension	Shear	45-Degree
		lbs. (kN)	lbs. (kN)	lbs. (kN)	lbs. (kN)	lbs. (kN)	lbs. (kN)	lbs. (kN)	lbs. (kN)
CSI Spiral Ceiling Clips with 8mm Head Pin (0.157" Shank)	3/4 (19)	75 (0.3)	135 (0.6)	100 (0.4)	175 (0.8)	130 (0.6)	100 (0.4)	175 (0.8)	130 (0.6)
	1 (25)	135 (0.6)	180 (0.8)	170 (0.8)	230 (1.0)	215 (1.0)	170 (0.8)	230 (1.0)	215 (1.0)
Standard Ceiling Clips with 0.300" Head Pin (0.145" Shank)	3/4 (19)	40 (0.2)	65 (0.3)	125 (0.6)	105 (0.5)	-	190 (0.8)	170 (0.8)	-
	7/8 (22)	40 (0.2)	65 (0.3)	140 (0.6)	160 (0.7)	145 (0.6)	200 (0.9)	245 (1.1)	155 (0.7)
	1 (25)	110 (0.5)	110 (0.5)	140 (0.6)	160 (0.7)	145 (0.6)	200 (0.9)	245 (1.1)	155 (0.7)
	1-1/8 (29)	110 (0.5)	110 (0.5)	150 (0.7)	160 (0.7)	155 (0.7)	225 (1.0)	275 (1.2)	155 (0.7)
Extended Length (XL) Ceiling Clips with 0.300" Head Pin (0.145" Shank)	3/4 (19)	105 (0.5)	175 (0.8)	115 (0.5)	195 (0.9)	-	115 (0.5)	195 (0.9)	-
	1 (25)	135 (0.6)	250 (1.1)	165 (0.7)	280 (1.2)	-	145 (1.1)	280 (1.2)	-
Ceiling Clips with 8mm Head Pin (0.145" Shank)	3/4 (19)	40 (0.2)	65 (0.3)	65 (0.3)	105 (0.5)	-	70 (0.3)	145 (0.6)	-
	7/8 (22)	40 (0.2)	65 (0.3)	75 (0.3)	145 (0.6)	125 (0.6)	70 (0.3)	145 (0.6)	125 (0.6)
	1 (25)	40 (0.2)	110 (0.5)	75 (0.3)	160 (0.7)	125 (0.6)	100 (0.4)	160 (0.7)	125 (0.6)
Economy Ceiling Clips with 0.300" Head Pin (0.145" Shank)	3/4 (19)	40 (0.2)	75 (0.3)	40 (0.2)	75 (0.3)	-	70 (0.3)	145 (0.6)	-
	1 (25)	40 (0.2)	120 (0.5)	40 (0.2)	150 (0.7)	-	100 (0.4)	150 (0.7)	-

1. Fasteners must not be driven until the concrete has reached the minimum designated compressive strength. Linear interpolation may be used to determine allowable loads for intermediate compressive strengths. For a concrete compressive strength of 5,000 psi, the tabulated allowable loads for 0.145-inch shank pins in 4,000 psi concrete compressive strength may be considered for use but allowable loads must not be increased.
2. The tabulated tension and shear values are for the fasteners assemblies. Steel wire or other components connected with the substrate must be investigated for compliance with the applicable code.
3. Allowable load capacities are calculated using minimum required factors of safety in accordance with ICC-ES AC70; the minimum applied factor of safety is 5.0. Consideration of additional safety factors may be necessary depending on the application such as life safety.
4. Concrete member thickness must be a minimum of three times the fastener embedment depth.
5. Ceiling clips with a 0.145-inch shank pin must have a minimum spacing distance of 3 inches and a minimum edge distance of 3 inches in accordance with ASTM E 1190. Consideration of smaller spacing and edge distances may be given based on application or jobsite testing.
6. Ceiling clips with a 0.157-inch shank pin must have a minimum spacing distance of 4 inches and a minimum edge distance of 3-1/2 inches in accordance with ASTM E 1190. Consideration of smaller spacing and edge distances may be given based on application or jobsite testing.
7. Multiple fasteners are recommended for any attachment for increased reliability.

**POWDER-ACTUATED**

**CEILING CLIP ASSEMBLIES**  
Standard Domed Head Fasteners

### Allowable Load Capacities for Ceiling Clips in Lightweight Concrete and Sand-Lightweight Concrete over Steel Deck<sup>1,2,3,7</sup>

Fastener Description	Min. Embed. Depth in. (mm)	Minimum Concrete Compressive Strength, f'c = 3,000 psi					
		Through Soffit of Steel Deck Into Concrete (3-inch Deep Profile) <sup>4,5,6</sup>			Through Soffit of Steel Deck Into Concrete (1-1/2-inch Deep Profile) <sup>4,5,6</sup>		
		Upper or Lower Flute			Upper or Lower Flute		
		Tension	Shear	45-Degree	Tension	Shear	45-Degree
		lbs. (kN)	lbs. (kN)	lbs. (kN)	lbs. (kN)	lbs. (kN)	lbs. (kN)
CSI Spiral Ceiling Clips with 8mm Head Pin (0.157" Shank)	3/4 (19)	80 (0.4)	220 (1.0)	135 (0.6)	80 (0.4)	220 (1.0)	135 (0.6)
	7/8 (22)	110 (0.5)	250 (1.1)	205 (0.9)	80 (0.4)	220 (1.0)	135 (0.6)
Standard Ceiling Clips with 0.300" Head Pin (0.145" Shank)	3/4 (19)	50 (0.2)	120 (0.5)	40 (0.2)	35 (0.2)	90 (0.4)	40 (0.2)
	7/8 (22)	80 (0.4)	220 (1.0)	120 (0.5)	80 (0.4)	210 (0.9)	120 (0.5)
	1 (25)	120 <sup>(8)</sup> (0.5)	325 <sup>(9)</sup> (1.4)	145 <sup>(10)</sup> (0.6)	-	-	-
	1-1/8 (29)	120 <sup>(8)</sup> (0.5)	325 <sup>(9)</sup> (1.4)	145 <sup>(10)</sup> (0.6)	-	-	-
Ceiling Clips with 8mm Head Pin (0.145" Shank)	3/4 (19)	35 (0.2)	120 (0.5)	40 (0.2)	-	-	-
	7/8 (22)	55 (0.2)	285 (1.3)	100 (0.4)	-	-	-
	1 (25)	55 (0.2)	285 (1.3)	100 (0.4)	-	-	-
Economy Ceiling Clips with 0.300" Head Pin (0.145" Shank)	3/4 (19)	30 (0.1)	135 (0.6)	40 (0.2)	-	-	-
	1 (25)	55 (0.2)	135 (0.6)	45 (0.2)	-	-	-

- Fasteners must not be driven until the concrete has reached the minimum designated compressive strength. For a concrete compressive strength of 4,000 psi, the tabulated allowable loads for 0.157-inch shank pins may be considered for use but loads must not be increased. For a concrete compressive strength of 4,000 psi, the tabulated allowable loads for 0.145-inch shank pins may be increased by 12 percent.
- The tabulated tension and shear values are for the fastener assemblies only. Steel wire or components connected with the substrate must be investigated for compliance with the applicable code.
- Allowable load capacities are calculated using minimum required factors of safety in accordance with ICC-ES AC70; the minimum applied factor of safety is 5.0. Consideration of additional safety factors may be necessary depending on the application such as life safety.
- For fasteners installed into the upper flute of the steel deck profile, the concrete thickness above the deck (topping thickness) must be a minimum of 3.25 inches. For fasteners installed into the lower flute of the steel deck profile, the concrete thickness above the deck (topping thickness) must be a minimum of 2.25 inches.
- Fastener assemblies with a 0.157-inch shank pin installed into steel deck profiles must have a minimum spacing distance of 3 inches (upper and lower flute). Fastener assemblies with a 0.145-inch shank pin installed into steel deck profiles must have a minimum spacing distance of 3 inches (upper and lower flute). Unless otherwise noted, fastener assemblies must have a minimum edge distance of 1-1/8 inches (lower flute) for 3-inch-deep profiles and a minimum edge distance of 7/8 inches (lower flute) for 1-1/2 inch-deep profiles; minimum deck end distance is 3-1/2 inches for 0.157-inch shank pins and 3 inches for 0.145-inch shank pins. Consideration of smaller spacing distances may be given based on application or jobsite testing.
- Embedment is measured from the surface of the steel deck; the steel deck panel must have a base-metal thickness of 0.030-inch (22 gauge) to 0.048-inch (18 gauge).
- Multiple fasteners are recommended for any attachment for increased reliability.
- For upper flute locations, these allowable loads may be increased to 135 lbs.
- For upper flute locations, these allowable loads may be increased to 350 lbs.
- For upper flute installations, these allowable loads may be increased to 180 lbs.

CONCRETE OVER STEEL DECK  
3-inch Deep Profile

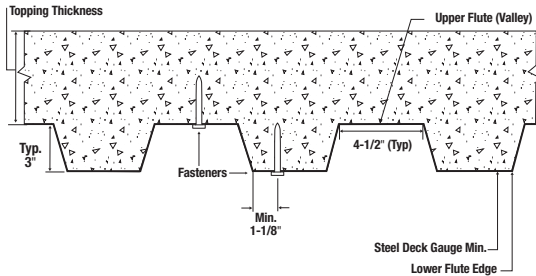

CONCRETE OVER STEEL DECK  
1-1/2-inch Deep Profile

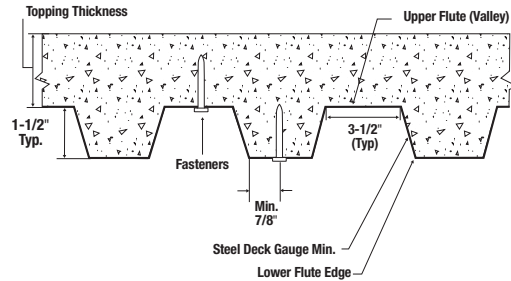

**Allowable Load Capacities for Ceiling Clips in ASTM A36 Steel<sup>1,2,3,4,5,6</sup>**

Fastener Description	Nominal Steel Thickness (inch)							
	1/8		3/16		1/4		3/8	
	Tension lbs. (kN)	Shear lbs. (kN)	Tension lbs. (kN)	Shear lbs. (kN)	Tension lbs. (kN)	Shear lbs. (kN)	Tension lbs. (kN)	Shear lbs. (kN)
CSI Spiral Ceiling Clips with 8mm Head Pin (0.157 Shank)	-	-	-	-	350 (1.6)	420 (1.9)	325 (1.4)	400 (1.8)
Ceiling Clips with 0.300" Head Pin (0.145" Shank)	140 (0.6)	350 (1.6)	220 (1.0)	240 (1.1)	345 (1.5)	385 (1.7)	190 (0.8)	255 (1.1)
Economy Ceiling Clips with 0.300" Head Pin (0.145" Shank)	190 (0.8)	260 (1.2)	210 (0.9)	260 (1.2)	210 (0.9)	240 (1.1)	-	-
Ballistic Ceiling Clips with 0.300" Head Pin (0.150" Shank)	-	-	-	-	350 (1.6)	510 (2.3)	190 (0.8)	240 (1.1)

- Fastener capacities are based on the base steel with a minimum yield strength (F<sub>y</sub>) of 36 ksi and a minimum ultimate tensile strength (F<sub>u</sub>) of 58 ksi. The pointed portion of the fastener must penetrate the steel member unless otherwise noted.
- The tabulated tension and shear values are for the fastener assemblies only. Steel wire or other components connected to the steel substrate must be investigated for compliance with the applicable code.
- Allowable load capacities are calculated using minimum required factors of safety in accordance with ICC-ES AC70; the minimum applied factor of safety is 5.0. Consideration of additional safety factors may be necessary depending on the application such as life safety.
- Ceiling clips with a 0.145-inch shank pin or 0.150-inch shank pin must have a minimum spacing distance of 3 inches and a minimum edge distance of 3 inches in accordance with ASTM E 1190. Consideration of smaller spacing and edge distances may be given based on application or jobsite testing.
- Ceiling clips with a 0.157-inch shank pin must have a minimum spacing distance of 4 inches and a minimum edge distance of 3-1/2 inches in accordance with ASTM E 1190. Consideration of smaller spacing and edge distances may be given based on application or jobsite testing.
- Multiple fasteners are recommended for any attachment for increased reliability.

**Allowable Load Capacities for Ceiling Clips in ASTM A572 or A992 Steel<sup>1,2,3,4,5,6</sup>**

Fastener Description	Nominal Steel Thickness (inch)			
	1/4		3/8	
	Tension lbs. (kN)	Shear lbs. (kN)	Tension lbs. (kN)	Shear lbs. (kN)
CSI Spiral Ceiling Clips with 8mm Head Pin (0.157 Shank)	350 (1.6)	420 (1.9)	325 (1.4)	400 (1.8)
Standard Ceiling Clips with 0.300" Head Pin (0.145" Shank)	375 (1.7)	415 (1.8)	205 (0.9)	275 (1.2)
Ballistic Ceiling Clips with 0.300" Head Pin (0.150" Shank)	380 (1.7)	550 (2.4)	205 (0.9)	255 (1.1)

- Fastener capacities are based on the base steel with a minimum yield strength (F<sub>y</sub>) of 50 ksi and a minimum ultimate tensile strength (F<sub>u</sub>) of 65 ksi. The pointed portion of the fastener must penetrate the steel member unless otherwise noted.
- The tabulated tension and shear values are for the fastener assemblies only. Steel wire or other components connected to the steel substrate must be investigated for compliance with the applicable code.
- Allowable load capacities are calculated using minimum required factors of safety in accordance with ICC-ES AC70; the minimum applied factor of safety is 5.0. Consideration of additional safety factors may be necessary depending on the application such as life safety.
- Ceiling clips with a 0.145-inch shank pin or 0.150-inch shank pin must have a minimum spacing distance of 3 inches and a minimum edge distance of 3 inches in accordance with ASTM E 1190. Consideration of smaller spacing and edge distances may be given based on application or jobsite testing.
- Ceiling clips with a 0.157-inch shank pin must have a minimum spacing distance of 4 inches and a minimum edge distance of 3-1/2 inches in accordance with ASTM E 1190. Consideration of smaller spacing and edge distances may be given based on application or jobsite testing.
- Multiple fasteners are recommended for any attachment for increased reliability.

**ORDERING INFORMATION**

**CSI Spiral Drive Pin with Ceiling Clip (90 degree)**

Cat. No.	Shank Length	Head Dia.	Shank Dia.	Wire Hole	Ctn Qty.	Mstr Qty.
50212	22mm (7/8") (TH)	8mm	0.157"	0.313"	100	1,000
50213	27mm (1") (TH)	8mm	0.157"	0.313"	100	1,000
50218	32mm (1-1/4") (TH)	8mm	0.157"	0.313"	100	1,000

Clips are 3/4-inch wide and 2mm thick.  
TH = Top Hat



**.300" Head Drive Pins with Ceiling Clips (90 degree)**

Cat. No.	Shank Length	Shank Diameter	Wire Hole	Ctn Qty.	Mstr Qty.
50364	1"	0.145"	0.278"	100	1,000
50370	1-1/4"	0.145"	0.278"	100	1,000
DFD3373*	1"	0.145"	0.278"	100	1,000
DFD3374*	1-1/4"	0.145"	0.278"	100	1,000

Clips are 3/4-inch wide and 2mm thick.  
\* Extended Length (XL) clips

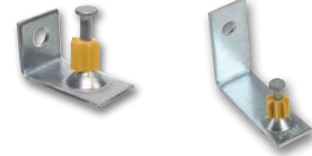

**8mm Head Drive Pin with Ceiling Clip (90 degree)**

Cat. No.	Shank Length	Shank Diameter	Wire Hole	Ctn Qty.	Mstr Qty.
50272	27mm (1")	0.145"	0.278"	100	1,000
50274	32mm (1-1/4")	0.145"	0.278"	100	1,000
50206	27mm (1") TH	0.177"	0.313"	100	1,000

Clips are 3/4-inch wide and 2mm thick.  
TH = Top Hat



**0.300" Head Drive Pins with Economy Ceiling Clips (60 degree)**

Cat. No.	Shank Length	Shank Diameter	Wire Hole	Ctn Qty.	Mstr Qty.
50368	1-1/8"	0.145"	0.278"	100	1,000
50374	1-1/4"	0.145"	0.278"	100	1,000

Clips are 5/8-inch wide and 14 gauge thick.



**Ballistic Point Drive Pin with Ceiling Clip**

Cat. No.	Shank Length	Head Dia.	Shank Dia.	Wire Hole	Ctn Qty.	Mstr Qty.
50366	7/8" (TH)	0.300"	0.150"	0.313"	100	1,000
50058	1-1/4"	0.300"	0.181/0.150"	0.278"	100	1,000

Clips are 3/4-inch wide and 2mm thick. Ballistic point pins have a black coating instead of zinc plating.  
The 50366 is assembled with a 90 degree clip and the 50058 is assembled with a 60 degree clip.  
TH = Top Hat

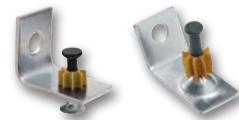

**Ceiling Clip without Pin (90 degree)**

Cat. No.	Description	Ctn Qty.	Mstr Qty.
50400	Ceiling Clip (no pin), 3/4-inch wide and 14 gauge thick. Long leg is 1-1/4" long with 7/32" hole; short leg is 5/8" long with 5/16" hole.	100	1,000

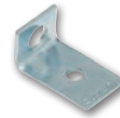



**GENERAL INFORMATION**

**THREADED STUDS, ROD HANGERS & ASSEMBLIES**

**PRODUCT DESCRIPTION**

Threaded studs are available in 1/4"-20 and 3/8"-16 thread diameters with a variety of external thread and shank lengths for use in concrete, concrete over steel deck, concrete masonry walls and steel. They are used for applications where it may be desirable to remove the fixture or where shimming may be required or for suspending small diameter pipe (e.g. water lines, sprinkler systems). Knurled shank designs are available to increase performance in steel base materials. A plastic flute is mounted on the pin shank to retain the drive pin in the barrel of the tool providing guidance during the driving operation.

Rod hangers and post nut hanger clips are available for suspending mechanical and electrical components from concrete and steel. They have an internally threaded clip or post nut designed to accept either 1/4"-20 or 3/8"-16 threaded rod.

For the electrical trade, BX and EMT (electrical metallic tubing) conduit clips are provided in various sizes for attaching conduit to base materials where easy removal is not a requirement.

Rebar basket clips are typically used in highway construction and paving applications to hold the support baskets for the reinforcing bars in place while the concrete is being poured.

**GENERAL APPLICATIONS AND USES**

- Threaded stud attachments for concrete, concrete over steel deck, concrete masonry and steel
- Attaching threaded rod hangers to concrete or steel
- BX cable and EMT (electrical metallic tubing) attachments
- Rebar/dowel basket anchorage

**APPROVALS AND LISTINGS**

- International Code Council, Evaluation Service (ICC-ES), ESR-2024
- Code compliant with the International Building Code/International Residential Code: 2018 IBC/IRC, 2015 IBC/IRC, 2012 IBC/IRC, and 2009 IBC/IRC
- Tested in accordance with ASTM E1190 and ICC-ES AC70 for use in concrete, concrete masonry and steel

**GUIDE SPECIFICATION**

- CSI Divisions: 03 15 00 - Concrete Accessories, 05 05 23 - Metal Fastenings, 06 05 23 - Wood, Plastic and Composite Fastenings, 09 22 16.23 - Fasteners. Powder-driven fasteners shall be threaded studs, rod hangers & assemblies as supplied by DEWALT, Towson, MD. Fasteners shall be installed in accordance with published instructions and the Authority Having Jurisdiction.

**SELECTION GUIDE**

Pin / Fastener Assembly		Dimensions		Base Material				DEWALT Tools				Approvals & Listings				
		Shank Diameter	Shank Length	Concrete	Lightweight Concrete	Concrete over Steel Deck	Concrete Masonry (CMU)	Steel	P1000 / T1000	P2201	P35S		P3500 / PA3500	P3600	Sniper	DFD270
Threaded Studs	1/4"-20 Threaded Stud (UNC)	0.145"	1/2" to 1-1/4"	●	●	●	●	○	○	●	●	●	●	●	●	ICC-ES ESR-2024
	3/8"-16 Threaded Stud (UNC)	0.205"	3/4" to 1-1/4"	●	●	●	○	○					●			ICC-ES ESR-2024
Hangers	Post Nut Hangers (0.300" Head Pins)	0.145"	1-1/8" to 1-1/4"	●	●	●	○	○	○	●	●	●	●	●	●	ICC-ES ESR-2024
	Rod Hangers (0.300" Head Pins)	0.145"	1-1/8" to 1-1/4"	●	●	●	○	○	○	●	●	●	●	●	●	
Assemblies	BX-EMT Conduit Clip (0.300" & 8mm Head Pins)	0.145"	1" to 1-1/4" (27mm to 32mm)	●	●	●	●	●	●	●	●	●	●	●	●	
	Rebar/Dowel Basket Clip (8mm Head Pins)	0.145"	37mm to 72mm (1-1/2" to 2-7/8")	●	●	○	○	○	○	●	●	●	●	●	●	

● Suitable ○ May be Suitable

**SECTION CONTENTS**

General Information.....31  
 Selection Guide .....31  
 Performance Data.....32  
 Ordering Information.....34



**THREADED STUDS**



**ROD HANGERS**

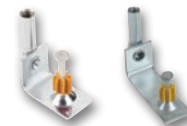

**POST NUT HANGERS - STANDARD AND EXTENDED LENGTH (XL)**



**CONDUIT CLIPS**



**REBAR/DOWEL BASKET CLIPS**

**SUITABLE BASE MATERIALS**

- Normal-weight concrete
- Lightweight concrete
- Concrete over steel deck
- Grouted concrete masonry (CMU)
- Hollow concrete masonry (CMU)
- Steel

**FASTENER SIZE RANGE**

- 7/8" length through 1-1/4" length

**CODE LISTED**  
ICC-ES ESR-2024  
CONCRETE, MASONRY, STEEL

**PERFORMANCE DATA**

**Allowable Load Capacities for Powder Actuated Fasteners in Normal-Weight Concrete**<sup>1,2,3,4,5,6,7</sup>

Fastener Description	Minimum Embed. Depth in. (mm)	Minimum Concrete Compressive Strength (f <sub>c</sub> )							
		2,000 psi		3,000 psi		4,000 psi		5,000 psi	
		Tension lbs. (kN)	Shear lbs. (kN)	Tension lbs. (kN)	Shear lbs. (kN)	Tension lbs. (kN)	Shear lbs. (kN)	Tension lbs. (kN)	Shear lbs. (kN)
1/4"-20 Threaded Stud (0.145" Shank)	5/8 (15.9)	25 (0.1)	45 (0.2)	60 (0.3)	95 (0.4)	45 (0.2)	95 (0.4)	25 (0.1)	95 (0.4)
	3/4 (19.1)	60 (0.3)	95 (0.4)	95 (0.4)	125 (0.6)	95 (0.4)	125 (0.6)	100 (0.4)	125 (0.6)
	1 (25.4)	100 (0.4)	140 (0.6)	130 (0.6)	155 (0.7)	155 (0.7)	155 (0.7)	180 (0.8)	200 (0.9)
	1-1/4 (31.8)	110 (0.5)	155 (0.7)	155 (0.7)	165 (0.7)	195 (0.9)	165 (0.7)	235 (1)	200 (0.9)
3/8"-16 Threaded Stud (0.205" Shank)	1 (25.4)	95 (0.4)	135 (0.6)	80 (0.4)	135 (0.6)	160 (0.7)	110 (0.5)	160 (0.7)	110 (0.5)
	1-1/4 (31.8)	170 (0.8)	220 (1)	165 (0.7)	220 (1)	200 (0.9)	320 (1.4)	200 (0.9)	320 (1.4)
0.300" Head Drive Pin with Post Nut Hanger (0.145" Shank)	1 (25.4)	-	-	180 (0.8)	-	180 (0.8)	-	-	-
8mm Head Drive Pin with Rod Hanger (0.145" Shank)	1 (25.4)	-	-	120 (0.5)	-	120 (0.5)	-	-	-
CSI Spiral Pin with Rod Hanger (0.157" Shank)	1 (25.4)	-	-	110 (0.5)	-	110 (0.5)	-	-	-

- Fasteners must not be driven until the concrete has reached the minimum designated compressive strength. Linear interpolation may be used to determine allowable loads for intermediate compressive strengths.
- Concrete thickness must be a minimum of three times the embedment depth.
- The allowable tension and shear values are for fasteners only. Steel or wood members connected to the substrate must be investigated for compliance with the applicable code.
- Allowable load capacities are calculated using minimum required factors of safety in accordance with ICC-ES AC70; the minimum applied factor of safety is 5.0. Consideration of additional safety factors may be necessary depending on the application such as life safety.
- Fasteners must have a minimum spacing distance of 3 inches for 0.145-inch shank fasteners, 4 inches for 0.157-inch shank fasteners and 6 inches for 0.205" shank fasteners in accordance with ASTM E 1190.
- Minimum edge distance is 3 inches for 0.145-inch shank fasteners and 3-1/2 inches for 0.157-inch shank fasteners and 0.205-inch shank fasteners. Consideration of smaller spacing and edge distances may be given based on application or jobsite testing.
- Multiple fasteners are recommended for any attachment for increased reliability.

**Allowable Load Capacities for Powder Actuated Fasteners in Lightweight Concrete and Sand-Lightweight Concrete over Steel Deck (3,000 psi)**<sup>1,2,3,9,10</sup>

Fastener Description	Minimum Embed. Depth in. (mm)	Minimum Concrete Compressive Strength (f <sub>c</sub> )					
		Directly into Concrete <sup>4,5,6</sup>		Through Soffit of Steel Deck into Concrete <sup>5,7,8</sup>			
		Tension lbs. (kN)	Shear lbs. (kN)	Lower Flute		Upper Flute	
		Tension lbs. (kN)	Shear lbs. (kN)	Tension lbs. (kN)	Shear lbs. (kN)	Tension lbs. (kN)	Shear lbs. (kN)
1/4"-20 Threaded Stud (0.145" Shank)	1 (25.4)	70 (0.3)	35 (0.2)	35 (0.2)	160 (0.7)	35 (0.2)	160 (0.7)
	1-1/4 (31.8)	70 (0.3)	125 (0.6)	65 (0.3)	170 (0.8)	65 (0.3)	170 (0.8)
3/8"-16 Threaded Stud (0.205" Shank)	1 (25.4)	70 (0.3)	130 (0.6)	45 (0.2)	165 (0.7)	45 (0.2)	165 (0.7)
	1-1/4 (31.8)	170 (0.8)	265 (1.2)	85 (0.4)	225 (1)	85 (0.4)	225 (1)

- Fasteners must not be driven until the concrete has reached the minimum designated compressive strength.
- The tension and shear values are for fasteners only. Steel or wood members connected to the substrate must be investigated for compliance with the applicable code.
- Allowable load capacities are calculated using minimum required factors of safety in accordance with ICC-ES AC70; the minimum applied factor of safety is 5.0. Consideration of additional safety factors may be necessary depending on the application such as life safety.
- For fasteners installed directly into concrete, the member thickness must be a minimum of 3.25 inches.
- Fasteners must have a minimum spacing distance of 3 inches for 0.145-inch shank fasteners and 6 inches for 0.205" shank fasteners in accordance with ASTM E 1190.
- Minimum edge distance is 3 inches for 0.145-inch shank fasteners and 3-1/2 inches for 0.205-inch shank fasteners. Consideration of smaller spacing and edge distances may be given based on application or jobsite testing.
- For fasteners installed into the upper flute of the steel deck profile the concrete thickness above the deck (topping thickness) must be a minimum of 3.25 inches; or for fasteners installed into the lower flute of the steel deck profile, the concrete thickness above the deck (topping thickness) must be a minimum of 2.25 inches.
- Fasteners installed into the soffit of the steel deck profile must have a minimum edge distance of 1-1/8 inches (lower flute); minimum deck end distance is 3 inches for 0.145-inch shank fasteners and 3-1/2 inches for 0.205-inch shank fasteners. Consideration of smaller spacing distances may be given based on application or jobsite testing.
- Embedment is measured from the surface of the steel deck; the steel deck panel must have a base-metal thickness of 0.030-inch (22 gauge) to 0.048-inch (18 gauge).
- Multiple fasteners are recommended for any attachment for increased reliability.

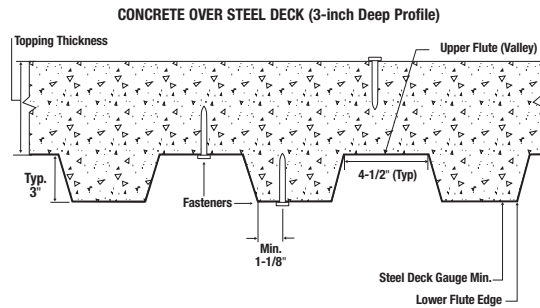

**Allowable Load Capacities for Powder Actuated Fasteners in ASTM A36 Steel<sup>1,2,3,4</sup>**

Fastener Description	Shank Type	Nominal Steel Thickness							
		1/8"		3/16"		1/4"		3/8"	
		Tension lbs. (kN)	Shear lbs. (kN)	Tension lbs. (kN)	Shear lbs. (kN)	Tension lbs. (kN)	Shear lbs. (kN)	Tension lbs. (kN)	Shear lbs. (kN)
1/4"-20 Threaded Stud (0.145" Shank)	Knurled	220 (1.0)	445 (2.0)	465 (2.1)	495 (2.2)	565 (2.5)	545 (2.4)	510 (2.3)	750 (3.3)
3/8"-16 Threaded Stud (0.205" Shank)	Knurled	225 (1.0)	555 (2.5)	540 (2.4)	590 (2.6)	745 (3.3)	620 (2.8)	-	-

- The allowable tension and shear values are for fasteners only. Steel or wood members connected to the substrate must be investigated for compliance with the applicable code.
- Allowable load capacities are calculated using minimum required factors of safety in accordance with ICC-ES AC70; the minimum applied factor of safety is 5.0. Consideration of additional safety factors may be necessary depending on the application such as life safety.
- Fasteners must be driven to obtain an embedment equivalent to the nominal steel thickness with the point of the fastener penetrating through the steel base material.
- Multiple fasteners are recommended for any attachment for increased reliability.

**Allowable Load Capacities for Powder Actuated Fasteners in Concrete Masonry (f'm ≥ 1,500)<sup>1,2,3,4,9,10,11</sup>**

Fastener Description	Shank Diameter (inch)	Embed. Depth in. (mm)	Hollow CMU <sup>5</sup>				Grouted CMU <sup>6,7,8</sup>			
			Face Shell		Horizontal Mortar Joint		Face Shell		Horizontal Mortar Joint	
			Tension lbs. (kN)	Shear lbs. (kN)	Tension lbs. (kN)	Shear lbs. (kN)	Tension lbs. (kN)	Shear lbs. (kN)	Tension lbs. (kN)	Shear lbs. (kN)
1/4" - 20 Threaded Stud	0.145	1 (25.4)	185 (0.8)	180 (0.8)	60 (0.3)	120 (0.5)	175 (0.8)	220 (1.0)	135 (0.6)	220 (1.0)
3/8"-16 Threaded Stud	0.205	1 (25.4)	20 (0.1)	85 (0.4)	-	-	110 (0.5)	185 (0.8)	135 (0.6)	130 (0.6)

- Fasteners must not be driven until the masonry has reached the minimum designated compressive strength. Concrete masonry must be minimum 8-inch wide, minimum Grade N, Type II, lightweight, medium-weight or normal-weight units conforming to ASTM C90. Mortar must be minimum Type N complying with ASTM C270. Grout must be coarse grout complying with ASTM C476.
- The tabulated tension and shear values are for the fasteners only. Steel or wood members connected with the substrate must be investigated for compliance with the applicable code.
- Allowable load capacities are calculated using minimum required factors of safety in accordance with ICC-ES AC70; the minimum applied factor of safety is 5.0. Consideration of additional safety factors may be necessary depending on the application such as life safety.
- Fasteners installed into the face or end of hollow CMU must have a minimum end distance of 3-3/4 inches. No more than one fastener may be installed in an individual hollow concrete masonry unit cell.
- For installations into hollow CMU walls, 3/8"-16 threaded stud fasteners may not be placed into the mortar joint.
- Fasteners installed into grout-filled concrete masonry must have a minimum spacing distance of 4 inches and a minimum edge distance 3-3/4 inches.
- For installations into grout-filled concrete masonry walls, fasteners may be placed into the bed joint (horizontal mortar joint) provided the fasteners have a minimum spacing distance of 8 inches along the bed joint and have a minimum edge distance of 8 inches.
- Installations directly into the head joint (vertical mortar joint) and within 1-1/2 inch of the head joint is not recommended and must not be permitted.
- Allowable shear loads may be applied in any direction.
- Multiple fasteners are recommended for any attachment for increased reliability.
- Successful fastening into the face shell of hollow CMU and into the horizontal mortar joint is typically conducted with the lowest powder load level.

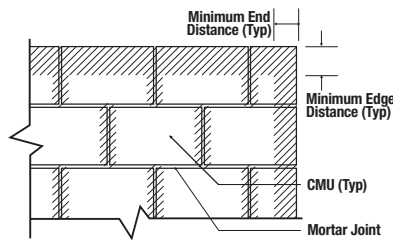

**Wall Face  
Permissible Anchor Locations  
(Un-hatched Area)**

**ORDERING INFORMATION**

**1/4"-20 Threaded Studs (UNC Thread)**

Cat. No.	Thread Length	Shank Length	Shank Dia.	Box Qty.	Mstr Qty.
50322	3/4"	1/2" (K)	0.145"	100	1,000
50326	3/4"	3/4"	0.145"	100	1,000
50328	1/2"	1"	0.145"	100	1,000
50330	3/4"	1"	0.145"	100	1,000
50336	3/4"	1-1/4"	0.145"	100	1,000
50338	1-1/4"	1-1/4"	0.145"	100	1,000

(K) = knurled



**3/8"-16 Threaded Studs (UNC Thread)**

Cat. No.	Thread Length	Shank Length	Shank Dia.	Box Qty.	Mstr Qty.
50340	1-1/4"	3/4" (K)	0.205"	100	1,000
50342	1-1/4"	1"	0.205"	100	1,000
50344	1-1/4"	1-1/4"	0.205"	100	1,000

(K) = knurled



**CSI Spiral and 8mm Head Drive Pins with Rod Hanger (UNC Thread)**

Cat. No.	Hanger Size	Shank Length	Shank Dia.	Box Qty.	Mstr Qty.
50215	1/4"-20	32mm (1-1/4") CSI Spiral	0.157"	100	1,000
50219	1/4"-20	32mm (1-1/4")	0.145"	100	1,000
50221	3/8"-16	32mm (1-1/4")	0.145"	100	1,000



**0.300" Head Drive Pins with Post Nut Rod Hanger (UNC Thread)**

Cat. No.	Hanger Size	Shank Length	Shank Dia.	Box Qty.	Mstr Qty.
50376-PWR	1/4"-20 (domed right angle clip)	1-1/8"	0.145"	100	1,000
50378-PWR	1/4"-20 (domed right angle clip)	1-1/4"	0.145"	100	1,000
DFD3388	1/4"-20 (XL right angle clip)	1-1/8"	0.145"	50	500
DFD3389	1/4"-20 (XL right angle clip)	1-1/4"	0.145"	50	500

XL = Extended Length

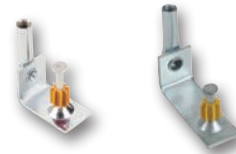

**0.300" Head Drive Pins with BX Cable Straps**

Cat. No.	Clip Size	Shank Length	Shank Dia.	Box Qty.	Mstr Qty.
50150	Std. BX Clip	1"	0.145"	100	1,000

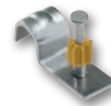

**0.300" Head Pins with Conduit Clips**

Cat. No.	Clip Size	Shank Length	Shank Dia.	Box Qty.	Mstr Qty.
50382	1/2" EMT (domed clip)	1"	0.145"	100	1,000
50384	3/4" EMT (domed clip)	1-1/4"	0.145"	100	500
50385	3/4" EMT	1"	0.145"	100	500
50386	3/4" EMT (domed clip)	1-1/8"	0.145"	100	500
50388	1" EMT	1"	0.145"	25	250



**8mm Head Drive Pins with EMT Conduit Clips**

Cat. No.	Clip Size	Shank Length	Shank Dia.	Box Qty.	Mstr Qty.
50276	1/2" EMT	27mm (1")	0.145"	100	1,000
50278	3/4" EMT	27mm (1")	0.145"	100	500
50280	1" EMT	27mm (1")	0.145"	25	250



**8mm Head Drive Pins with Rebar/Dowel Basket Clips**

Cat. No.	Clip Size	Shank Length	Shank Dia.	Box Qty.	Mstr Qty.
50704	Std. basket clip	37mm (1-1/2")	0.145"	100	100
50712	Std. basket clip	52mm (2")	0.145"	100	100
50716	Std. basket clip	62mm (2-1/2")	0.145"	100	100
50718	Std. basket clip	72mm (2-7/8")	0.145"	100	100



**GENERAL INFORMATION**

**P1000 / T1000**

Powder-Actuated Single Shot Tool

**TOOL DESCRIPTION**

The P1000 is a Hammer actuated, do-it-yourself (DIY) powder actuated tool. Engineered for high reliability, low maintenance and speed. This tool uses three levels of power: brown through yellow load (levels 2-4) and .300" Head Drive Pins, 8mm Head Fasteners with lengths of 1/2" through 3".

The T1000 is a do-it-yourself (DIY) grade powder actuated tool engineered for high reliability, low maintenance and speed. Its easy to use trigger mechanism makes fastening to concrete, block and steel. The tool uses .22 caliber (short) powder loads and can be actuated with the built-in trigger without the need for a hammer.

**TECHNICAL DATA**

<b>Tool Body</b>	Precision Moulded Rubber and Steel
<b>Tool Length</b>	13"
<b>Tool Weight</b>	3 lbs
<b>Pin Length</b>	1/2" to 3"
<b>Load Type</b>	.22 Caliber (Short) Load
<b>Power Level</b>	Brown (2), Green (3), Yellow (4)

**GENERAL APPLICATION AND USES**

- Remodeling
- Maintenance Applications
- Electrical Fixtures
- Telecommunications

**TARGET USERS**

- Homeowners
- Residential contractors

**SUGGESTED APPLICATION**

- Wood-to-concrete residential framing
- Clip assemblies to concrete or block

**ORDERING INFORMATION**

**P1000 Tool**

Cat. No.	Description	Ctn. Qty.	Mstr Qty.
DDF211000P	P1000 Tool (Blister Pack)	1	5

**T1000 Tool**

Cat. No.	Description	Ctn. Qty.	Mstr Qty.
DDF211010P	T1000 Tool (Blister Pack)	1	5

**SECTION CONTENTS**

General Information.....35  
Ordering Information.....35



P1000



T1000

**PINS**

- CSI Spiral Drive Pins
- 0.300" Head Drive Pins
- 8mm Head Drive Pins
- 1/4"-20 Threaded Studs

**PIN SIZE RANGE (TYP.)**

- 1/2" to 3"

**LOADS**

- .22 Caliber (Shorts)

**SUITABLE BASE MATERIALS**

- Concrete
- Concrete Masonry (CMU)
- Steel

## GENERAL INFORMATION

# P2201

Powder-Actuated Single Shot Tool

### TOOL DESCRIPTION

The P2201 is a low velocity, single shot, .22 caliber tool which can be used to install 0.300" head drive pins, 8mm head drive pins and 1/4"-20 threaded studs, up to 3" in total length. The P2201 is designed for maintenance or residential contractors.

### TECHNICAL DATA

<b>Tool Body</b>	Engineered Plastic and Steel
<b>Tool Length</b>	12-1/2"
<b>Tool Weight</b>	4.3 lbs
<b>Pin Length</b>	1/2" to 3" Total Length
<b>Load Type</b>	.22 Caliber (Short) Load
<b>Power Level</b>	Brown (2), Green (3), Yellow (4)

### GENERAL APPLICATION AND USES

- Conduit Clip to Concrete
- Electrical Fixture to Steel and Concrete
- Track to Floor
- Wood to Concrete
- Residential Construction
- Wood to Steel

### TARGET USERS

- Homeowners
- Residential contractors

### SUGGESTED APPLICATION

- Wood-to-concrete residential framing
- Clip assemblies to concrete or block

## SECTION CONTENTS

General Information.....36  
 Ordering Information.....36



P2201

### PINS

- CSI Spiral Drive Pins
- 0.300" Head Drive Pins
- 8mm Head Drive Pins
- 1/4"-20 Threaded Studs

### PIN SIZE RANGE (TYP.)

- 1/2" to 3"

### LOADS

- .22 Caliber (Shorts)

### SUITABLE BASE MATERIALS

- Normal-weight Concrete
- Concrete Masonry (CMU)
- Steel

## ORDERING INFORMATION

### P2201 Tool

Cat No.	Description	Ctn. Qty.	Mstr Qty.
DDF211022P	P2201 Tool (Blister Pack)	1	4

### Accessories

Cat No.	Description	Ctn. Qty.	Mstr Qty.
52522	Replacement Driver Piston for the P2201 Tool	1	-
52510	Replacement Nose Piece for the P2201 Tool	1	-
52512	Replacement Piston Reset Pin for the P2201 Tool	1	-

**GENERAL INFORMATION**

**P35S**

Powder-Actuated Load Strip Tool

**TOOL DESCRIPTION**

The P35s is specially designed for acoustical and drywall contractors. It is a low velocity, semi-automatic, tool which can be used to install 0.300" head drive pins, 8mm head drive pins and 1/4"-20 threaded studs up to 1-1/2" in total length. The P35s is designed for high speed and repetitive volume applications. The standard version of the tool is supplied with a flat end piston and a full size baseplate/guide. A limited access baseplate/guide assembly is also available.

**TECHNICAL DATA**

<b>Tool Body</b>	Precision Cast Aluminum and Steel
<b>Tool Length</b>	11-1/4"
<b>Tool Weight</b>	4.25 lbs
<b>Pin Length</b>	1/2" to 1-1/2" Total Length
<b>Load Type</b>	.25 Caliber Load Strip
<b>Power Level</b>	Green (3), Yellow (4), Red (5)

**GENERAL APPLICATION AND USES**

- Conduit Clip to Concrete
- Electrical Fixture to Steel
- Track to Floor
- Wood to Concrete
- Reliable and Compact for Short Pin Applications
- Electrical Fixture to Concrete
- Plywood to Steel
- Commercial Construction

**TARGET USERS**

- Commercial framers

**SUGGESTED APPLICATION**

- Metal track to concrete or steel

**ORDERING INFORMATION**

**P35s Tool**

Cat No.	Description	Ctn. Qty.
52002	P35s Tool (Deluxe Kit)	1

**Accessories**

Cat No.	Description	Ctn. Qty.
50065	6' Pole Tool	1
50066	8' Pole Tool	1
52200	Replacement Driver Piston for P35s Tool	1
52204	Replacement Driver Piston Guide for P35s Tool	
52206	Replacement Baseplate for P35s Tool	
52120	Replacement Shear Clip for P35s, P3500, PA3500, P3600 Tools	
52122	Replacement Steel Annular Ball for P35s, P3500, PA3500, P3600 Tools	

**SECTION CONTENTS**

General Information.....37  
Ordering Information.....37



P35S

**PINS**

- CSI Spiral Drive Pins
- 0.300" Head Drive Pins
- 8mm Head Drive Pins
- 1/4"-20 Threaded Studs

**PIN SIZE RANGE (TYP.)**

- 1/2" to 1-1/2"

**PIN SIZE RANGE (TYP.)**

- .25 Caliber

**SUITABLE BASE MATERIALS**

- Concrete
- Lightweight Concrete
- Concrete Masonry (CMU)
- Steel

## GENERAL INFORMATION

# P3500

Powder-Actuated Semi-automatic Tool

### TOOL DESCRIPTION

The P3500 is a low velocity, semi-automatic .27 caliber tool which can be used to install 0.300" head drive pins, 8mm head drive pins and 1/4"-20 threaded studs, up to 3" in total length. The P3500 is designed for high speed, durability and repetitive volume applications.

### TECHNICAL DATA

<b>Tool Body</b>	Precision Cast Aluminum and Steel
<b>Tool Length</b>	13-5/8"
<b>Tool Weight</b>	5 lbs.
<b>Pin Length</b>	1/2" to 3" Total Length
<b>Load Type</b>	.27 Caliber 10 Load Strip
<b>Power Level</b>	Brown (2), Green (3), Yellow (4), Red (5)

### GENERAL APPLICATION AND USES

- Conduit Clip to Concrete
- Wood to Steel
- Electrical Fixture to Steel
- Commercial and Residential Construction
- Wood to Concrete
- Electrical Fixture to Concrete
- Concrete Forming

### TARGET USERS

- MEP contractors

### SUGGESTED APPLICATION

- Clip assemblies to concrete, block, or steel

## ORDERING INFORMATION

### P3500 Tool

Cat No.	Description	Ctn. Qty.	Mstr Qty.
DDF212035P	P3500 Tool (Blister Pack)	1	2
52000	P3500 Tool (Deluxe Kit)	1	-

### Accessories

Cat No.	Description	Ctn. Qty.
50065	6' Pole Tool	1
50066	8' Pole Tool	1
52100	Replacement Driver Piston for P3500 Tool (Domed; for CSI and 8mm Head Drive Pins)	1
52102	Replacement Driver Piston for P3500 Tool (Flat; for .300" Head Drive Pins)	1
52108	Replacement Driver Piston Guide for P3500, PA3500 Tools	1
52110	Replacement Baseplate for P3500, PA3500 Tools	1
52112	Replacement Driver Piston Stop for P3500, PA3500, P3600 Tools	1
52120	Replacement Shear Clip for P35s, P3500, PA3500, P3600 Tools	1
52122	Replacement Steel Annular Ball for P35s, P3500, PA3500, P3600 Tools	1
52106	Replacement Driver Piston Ring for P3500, PA3500, P3600 Tools	1

### Limited Access Accessories for Applications in Tight Areas:

Cat No.	Description	Ctn. Qty.
52114	Limited Access Driver Piston Guide for P3500, PA3500 Tools	1
52116	Limited Access Baseplate for P3500, PA3500 Tools	1

## SECTION CONTENTS

General Information.....38  
 Ordering Information.....38



P3500

### PINS

- CSI Spiral Drive Pins
- .300" Head Drive Pins
- 8mm Head Drive Pins
- 1/4"-20 Threaded Studs

### PIN SIZE RANGE (TYP.)

- 1/2" to 3"

### LOADS

- .27 Caliber

### SUITABLE BASE MATERIALS

- Concrete
- Lightweight Concrete
- Concrete Masonry (CMU)
- Steel



**GENERAL INFORMATION**

**PA3500**

Powder-Actuated Semi-automatic Tool

**TOOL DESCRIPTION**

The PA3500 is a modified version of the P3500 that includes a power adjuster, allowing the operator to effectively decrease the power level of the load being used by up to two (2) levels. For example, a red load can be adjusted down to the level of a green load.

**TECHNICAL DATA**

<b>Tool Body</b>	Precision Cast Aluminum and Steel
<b>Tool Length</b>	13-5/8"
<b>Tool Weight</b>	5 lbs.
<b>Pin Length</b>	1/2" to 3" Total Length
<b>Load Type</b>	.27 Caliber 10 Load Strip and .27 Caliber Safety Strip
<b>Power Level</b>	Brown (2), Green (3), Yellow (4), Red (5)

**GENERAL APPLICATION AND USES**

- Conduit Clip to Concrete
- Electrical Fixture to Steel
- Wood to Concrete
- Concrete Forming
- Wood to Steel
- Commercial and Residential Construction
- Electrical Fixture to Concrete

**TARGET USERS**

- MEP contractors

**SUGGESTED APPLICATION**

- Clip assemblies to concrete, block, or steel

**ORDERING INFORMATION**

**PA3500 Tool**

Cat No.	Description	Ctn. Qty.
52019	PA3500 Tool (Blister Pack)	1

**Accessories**

Cat No.	Description	Ctn. Qty.
50065	6' Pole Tool	1
50066	8' Pole Tool	1
52103	Replacement Driver Piston for PA3500 Tool (Flat; for .300" Head Drive Pins)	1
52108	Replacement Driver Piston Guide for P3500, PA3500 Tools	1
52110	Replacement Baseplate for P3500, PA3500 Tools	1
52112	Replacement Driver Piston Stop for P3500, PA3500, P3600 Tools	1
52120	Replacement Shear Clip for P35s, P3500, PA3500, P3600 Tools	1
52122	Replacement Steel Annular Ball for P35s, P3500, PA3500, P3600 Tools	1
52106	Replacement Driver Piston Ring for P3500, PA3500, P3600 Tools	1
52106	Replacement Driver Piston Ring for P3500, PA3500, P3600 Tools	1

**Limited Access Accessories for Applications in Tight Areas:**

Cat No.	Description	Ctn. Qty.
52114	Limited Access Driver Piston Guide for P3500, PA3500 Tools	1
52116	Limited Access Baseplate for P3500, PA3500 Tools	1

**SECTION CONTENTS**

General Information..... 39  
Ordering Information..... 39



PA3500

**PINS**

- CSI Spiral Drive Pins
- 0.300" Head Drive Pins
- 8mm Head Drive Pins
- 1/4"-20 Threaded Studs

**PIN SIZE RANGE (TYP.)**

- 1/2" to 3"  
(Power adjuster must be set to 6 on dial for 3" pin to fit in tool)

**LOADS**

- .27 Caliber

**SUITABLE BASE MATERIALS**

- Concrete
- Lightweight Concrete
- Concrete Masonry (CMU)
- Steel

## GENERAL INFORMATION

# P3600

Powder-Actuated Semi-automatic Tool

### TOOL DESCRIPTION

The P3600 is a powerful, heavy-duty low velocity, semi-automatic .27 caliber tool which can be used to install 10mm head drive pins, 3/8" threaded studs, and 3/8" headed drive pins. The P3600 is designed for applications where more power is needed, such as attaching 2x4s to hard aggregate or steel. The tool utilizes a red or purple .27 caliber strip.

### TECHNICAL DATA

<b>Tool Body</b>	Precision Cast Aluminum and Steel
<b>Tool Length</b>	13-5/8"
<b>Tool Weight</b>	5 lbs.
<b>Pin Length</b>	1/2" to 3" Total Length
<b>Load Type</b>	.27 Caliber Load Strip
<b>Power Level</b>	Brown (2), Green (3), Yellow (4), Red (5)

### GENERAL APPLICATION AND USES

- Ceiling Clip assemblies
- Track to Floor, Door Frames
- Wood to Concrete
- Concrete Forms, Basket Clips, Forming Pins
- Electrical Fixture
- Duct Straps

### TARGET USERS

- MEP contractors

### SUGGESTED APPLICATION

- 3/8"-16 threaded studs into concrete or steel
- Clip assemblies to concrete, block, or steel

## ORDERING INFORMATION

### P3600 Tool

Cat No.	Description	Ctn. Qty.
52010	P3600 Tool (Deluxe Kit)	1

### Accessories

Cat No.	Description	Ctn. Qty.
50065	6' Pole Tool	1
50066	8' Pole Tool	1
52578	Replacement Driver Piston for P3600 Tool	1
52579	Replacement Driver Piston Guide for P3600 Tool	1
52112	Replacement Driver Piston Stop for P3500, PA3500, P3600 Tools	1
52120	Replacement Shear Clip for P35s, P3500, PA3500, P3600 Tools	1
52122	Replacement Steel Annular Ball for P35s, P3500, PA3500, P3600 Tools	1
52106	Replacement Driver Piston Ring for P3500, PA3500, P3600 Tools	1

## SECTION CONTENTS

General Information.....40  
 Ordering Information.....40



P3600

### PINS

- 10mm Head Drive Pins
- 3/8" Head Drive Pins
- 3/8"-16 Threaded Studs

### PIN SIZE RANGE (TYP.)

- 1/2" to 3"

### LOADS

- .27 Caliber

### SUITABLE BASE MATERIALS

- Normal-weight Concrete
- Structural Lightweight Concrete
- Concrete Masonry
- Steel

**GENERAL INFORMATION**

**SNIPER**

Powder-Actuated Semi-automatic Tool

**TOOL DESCRIPTION**

The Sniper pole tool is ideal for installing overhead ceiling clips mounted with pins up to 1-1/2" long. The tool features an internal safety sequence strip loading mechanism, that must be manually pulled to advance the next load.

**TECHNICAL DATA**

<b>Tool Body</b>	Precision Cast Aluminum and Steel
<b>Tool Length</b>	13"
<b>Tool Weight</b>	3 lbs
<b>Pin Length</b>	1/2" to 1-1/2"
<b>Load Type</b>	.27 Caliber Load Strip
<b>Power Level</b>	Brown (2), Green (3), Yellow (4), Red (5)

**GENERAL APPLICATION AND USES**

- Ceiling Clip Assemblies for acoustical ceiling grid and lighting fixtures
- Metal Track
- Electrical Fixtures to Steel
- Electrical Fixtures to Concrete

**TARGET USERS**

- MEP contractors

**SUGGESTED APPLICATION**

- Ceiling clip assemblies to overhead concrete or steel

**ORDERING INFORMATION**

**Sniper**

Cat No.	Description	Ctn. Qty.
52051	Sniper Tool (Kit)	1

**Accessories**

Cat No.	Description	Ctn. Qty.
52053	6' Pole Tool for Sniper Tool	1
52061	8' Pole Tool for Sniper Tool	1

**SECTION CONTENTS**

General Information..... 41  
Ordering Information..... 41



SNIPER

**PINS**

- CSI Spiral Drive Pins
- .300" Head Drive Pins
- 8mm Head Drive Pins
- 1/4"-20 Threaded Studs

**PIN SIZE RANGE (TYP.)**

- 1/2" to 1-1/2" Total Length

**LOADS**

- .27 Caliber

**SUITABLE BASE MATERIALS**

- Concrete
- Lightweight Concrete
- Steel

**POWDER-ACTUATED**

**SNIPER**

Powder-Actuated Semi-automatic Tool

## GENERAL INFORMATION

# DFD270

.27 Caliber Fully-Automatic Powder-Actuated Tool with Adjustable Power

### TOOL DESCRIPTION

The DFD270 .27 Caliber fully-automatic powder-actuated tool is designed for structural use in commercial steel and concrete applications. The nailer drives both 8mm and 0.300" head fasteners and clips in lengths of 1/2" – 2-7/8", as well as 1/4" threaded studs. It is powered by a standard .27 caliber (short) safety strip load. A power dial allows for adjustment within .27 caliber load colors. Tool-free disassembly allows for easy cleaning and maintenance. The DFD270 tool features automatic piston return and load indexing between fastenings, making it ideal for high-capacity commercial applications. With the addition of the DFD2703 accessory magazine, the tool can also fasten collated pins.

### TECHNICAL DATA

<b>Tool Body</b>	Engineered Plastic and Steel
<b>Tool Length</b>	18"
<b>Tool Weight</b>	7.1 lbs.
<b>Pin Length</b>	1/2" to 2-7/8"
<b>Load Type</b>	.27 Caliber Load Strip
<b>Power Level</b>	Brown (2), Green (3), Yellow (4), Red (5)

### GENERAL APPLICATION AND USES

- MEP contractors
- Commercial framers
- Metal track to concrete or steel
- Clip assemblies to concrete, block, or steel

### TARGET USERS

- MEP contractors
- Commercial framers

### SUGGESTED APPLICATION

- Metal track to concrete or steel
- Clip assemblies to concrete, block, or steel

## ORDERING INFORMATION

### DFD270 Tool

Cat No.	Description	Ctn. Qty.
DFD270SK	DFD270 Tool Single Shot (Deluxe Kit)	1
DFD270MK	DFD270 Tool Single Shot and Magazine (Deluxe Kit)	1

### Accessories

Cat No.	Description	Ctn. Qty.	Mstr Qty.
DFD2701	Replacement Driver Piston for DFD270 Tool (Flat; for .300" Head Drive Pins)	1	10
DFD2705	Replacement Driver Piston for DFD270 Tool (Domed; for CSI and 8mm Head Drive Pins)	1	10
DFD2702	Replacement Single Shot Nose Piece for DFD270 Tool	1	10
DFD2703	Replacement Magazine Nose Piece for DFD270 Tool	1	10
DFD2704	Cleaning Kit for DFD270 Tool	1	10

## SECTION CONTENTS

General Information.....42  
 Ordering Information.....42



DFD270

### PINS

- CSI Spiral Drive Pins
- 0.300" Head Drive Pins
- 8mm Head Drive Pins
- 1/4"-20 Threaded Studs

### PIN SIZE RANGE (TYP.)

- 1/2" to 2-7/8"

### LOADS

- .27 Caliber

### SUITABLE BASE MATERIALS

- Concrete
- Lightweight Concrete
- Concrete Masonry (CMU)
- Steel

**GENERAL INFORMATION**

**POWDER LOADS**

**PRODUCT DESCRIPTION**

DEWALT offers high quality powder loads, designed for consistency and reliability. Specific load types are designed for each caliber powder actuated tool. They are offered as single cartridge units for single shot tools and also collated in groups of 10 into plastic strips for semi-automatic tools.

**SELECTION GUIDE**

Loads	Load Power					DEWALT Tools								Examples of Other Tools*								
	Gray-Level 1	Brown-Level 2	Green-Level 3	Yellow-Level 4	Red-Level 5	P1000 / T1000	P2201	P35s	P3500 / PA3500	P3600	Sniper	DFD270	SA270	Cobra / Cobra+	Viper / Viper4	DX E37	DX600N	DX35	DX351	DX460 / DX5	DX2	
.22 Caliber Single (Short) Loads	•	•	•	•		•	•									•						
.27 Caliber Single (Long) Loads					•												•					
.25 Caliber 10-Load Strip			•	•	•			•										•				
.27 Caliber 10-Load Safety Strip		•	•	•	•				•	•	•	•	•	•	•				•	•	•	•

\* The indicated powder loads are generally compatible for form and fit in the examples given.

**ORDERING INFORMATION**

**.22 Caliber (Short) Loads**

Cat #	Size	Load Power	Box	Ctn.	Mstr.
50502	.22 Short	Brown (2)	100	5,000	240,000
50504	.22 Short	Green (3)	100	5,000	240,000
50506	.22 Short	Yellow (4)	100	5,000	240,000



**.27 Caliber (Long) Loads**

Cat #	Size	Load Power	Box	Ctn.	Mstr.
50612	.27 Long	Red (5)	100	2,500	100,000



**.25 Caliber Load Strips**

Cat #	Size	Load Power	Box	Ctn.	Mstr.
50570	.25 Strip	Green (3)	100	1,000	20,000
50574	.25 Strip	Yellow (4)	100	1,000	20,000
50578	.25 Strip	Red (5)	100	1,000	20,000
Master Pack					
50572	.25 Strip	Green (3)	1,000	20,000	-
50576	.25 Strip	Yellow (4)	1,000	20,000	-
50580	.25 Strip	Red (5)	1,000	20,000	-



**.27 Caliber Strip Load**

Cat #	Size	Load Power	Box	Ctn.	Mstr.
50620	.27 Safety Strip	Brown (2)	100	1,000	-
50622	.27 Safety Strip	Green (3)	100	1,000	-
50626	.27 Safety Strip	Yellow (4)	100	1,000	-
50630	.27 Safety Strip	Red (5)	100	1,000	-
Master Pack					
50624	.27 Safety Strip	Green (3)	-	1,000	10,000
50628	.27 Safety Strip	Yellow (4)	-	1,000	10,000
50632	.27 Safety Strip	Red (5)	-	1,000	10,000

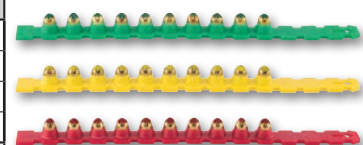

**SECTION CONTENTS**

General Information.....43  
Ordering Information.....43

**CORDLESS DIRECT FASTENING SYSTEMS**





<b>SELECTION GUIDE</b>	46
<b>CORDLESS TOOLS</b>	
<b>CORDLESS CONCRETE NAILER (CCN) TOOL</b>	47
<b>CORDLESS FASTENERS</b>	
<b>CCN CONCRETE FASTENERS</b>	48
<b>CCN STEEL FASTENERS</b>	48
<b>CCN SPECIALTY FASTENERS</b>	48
<b>CORDLESS ASSEMBLIES</b>	
<b>STICK-E ASSEMBLIES</b>	50
<b>CORDLESS ACCESSORIES</b>	
<b>CCN PARTS/ATTACHMENTS</b>	51

**CORDLESS DIRECT FASTENING SELECTION GUIDE**

Pins / Fasteners Description	Dimensions		Base Material						Stick-E Accessories	Approvals & Listings
	Shank Diameter	Shank Length	Concrete	Lightweight Concrete	Concrete over Steel Deck	Concrete Masonry (CMU)	Steel	Light Gauge Steel		
<b>CCN</b> Straight Shank Pins	0.102"	3/4" to 1-1/2"	●	●	●	●			●	ESR-4076
Tapered Shank Pins	0.120"	1/2"					●			ESR-4076
Tapered Shank Pins	0.120"	3/4"	●	●	●	●				ESR-4076
Straight Shank Pins	0.145"	3/4"	●	○	○	●				ESR-4076
Step Shank Pins	0.120"/0.102" (K)	0.680" to 0.730"	●	○			●			
Step Shank Pins	0.102/0.088" (K)	0.780"	●	○	○	●	○		●	
Spiral Shank Pin	0.108" (K)	1-3/8"						●	Denz Glass Washer	
Tapered Shank Pin	0.137"	2-1/4"	●	○						

● Suitable ○ May be Suitable  
(K) = Knurled



**GENERAL INFORMATION**

# CORDLESS CONCRETE NAILER (CCN)

Gas-Free Fastening System

**INTRODUCTION**

The 20V MAX\* Cordless Concrete Nailer is an operationally gas-free fastening system designed for use in concrete, concrete masonry block and steel applications. Running on only a DEWALT 20V MAX\* battery, this tool eliminates the need for fuel cells and powder loads. It provides a productive and powerful fastening solution with no licensing requirements, and can operate on the user's existing DEWALT battery platform. This system is ideal for commercial framing and track installation, light gauge mechanical and electrical installations, and can be considered for insulation, lathing and other surface prep applications. Stick-E assemblies are specially designed components for various fastening attachments into concrete, concrete masonry block and steel.

**GENERAL APPLICATIONS AND USES**

- Attaching light gauge steel track to concrete, concrete masonry block (CMU) or steel
- Attaching mechanical clips and fixings to concrete, concrete masonry block (CMU) or steel
- Attaching plywood to concrete or concrete masonry block (CMU)
- Attaching lath to concrete, concrete masonry block (CMU) or steel
- Attaching furring strips to concrete or concrete masonry block (CMU)

**FEATURES AND BENEFITS**

- + Gas-free operation and no licensing requirements
- + Field-serviceable driver blade and tool-free, interchangeable nosepieces
- + Adjustable power settings, low noise and recoil levels
- + Comparable application speed to gas concrete nailers
- + Dual LED lights illuminate work surface and provide tool diagnostics
- + Can be mounted on a pole tool
- + 600 shots per battery charge (see tool specifications section)\*\*

**APPROVALS AND LISTINGS**

- International Code Council, Evaluation Service (ICC-ES), ESR-4076
- Code compliant with the International Building Code/International Residential Code: 2018 IBC/IRC, 2015 IBC/IRC, 2012 IBC/IRC, and 2009 IBC/IRC
- Tested in accordance with ASTM E1190 and ICC-ES AC70 for use in concrete, lightweight concrete, concrete over steel deck, concrete masonry and steel

**GUIDE SPECIFICATIONS**

CSI Divisions: 03 15 00 - Concrete Accessories, 05 05 23 - Metal Fastenings, 06 05 23 - Wood, Plastic and Composite Fastenings, 09 22 16.23 - Fasteners. Power-driven fasteners shall be CCN fasteners as supplied by DEWALT, Towson, MD. Fasteners shall be installed in accordance with the published instructions and the Authority Having Jurisdiction.

**TOOL SPECIFICATIONS**

Tool Model	DCN890P2	DCN891B   DCN891P2
Tool Width	4"	4"
Tool Length	15.25"	15.25"
Tool Height	16.25"	15"
Tool Weight (Bare, without battery)	9.35 lbs	8.9 lbs.
Pin Length (Range)	1/2" to 2-1/4"	1/2" to 1"
Pin Capacity	33	33
Approximate Shots per Battery Charge**	600	600

\*For 20V MAX\* Maximum initial battery voltage measured without a workload is 20 volts. Nominal voltage is 18.  
\*\*With 5.0Ah battery pack (driving 0.102" diameter shank, 3/4" long fasteners into concrete)

**SECTION CONTENTS**

General Information.....47  
 Tool Specifications .....47  
 Performance Data.....48  
 Stick-E Assemblies .....50  
 Ordering Information.....51



20V MAX\* CORDLESS CONCRETE NAILER



CCN FASTENERS FOR CONCRETE AND MASONRY



CCN FASTENERS FOR STEEL



CCN SPECIALTY FASTENERS



STICK-E™ ASSEMBLIES

**SUITABLE BASE MATERIALS**

- Normal-weight concrete
- Lightweight concrete
- Grouted concrete masonry (CMU)
- Hollow concrete masonry
- Steel

**CORDLESS FASTENING**

**CORDLESS CONCRETE NAILER (CCN)**  
Gas-Free Fastening System

**PERFORMANCE DATA**

**Allowable Loads for CCN Fasteners Driven into Normal Weight Concrete<sup>1,2,3,4,5</sup>**

Shank Type	Shank Diameter (inch)	Minimum Embed. (inch)	Minimum Spacing (inch)	Minimum Edge Distance (inch)	Minimum Concrete Compressive Strength (f'c)							
					2,500 psi		3,000 psi		4,000 psi		6,000 psi	
					Tension (lbs)	Shear (lbs)	Tension (lbs)	Shear (lbs)	Tension (lbs)	Shear (lbs)	Tension (lbs)	Shear (lbs)
Straight	0.102	3/4	4	3-1/4	155	155	175	175	195	170	-	-
			4	2	125	135	145	155	140	170	-	-
	0.145	3/4	4	3-1/4	125	125	145	145	140	180	-	-
			4	2	120	125	140	145	140	180	-	-
Tapered	0.120	5/8	3-1/4	3-1/4	150	120	170	135	170	145	75	135
			2-3/4		150	120	170	135	165	135	75	135
			2		150	90	170	100	160	100	75	95
			2		150	90	170	100	160	100	75	95

For SI: 1 lbf = 4.48 N, 1 inch = 25.4mm, 1 psi = 6.895 kPa

- Fasteners must not be driven until the concrete has reached the tabulated compressive strength.
- Concrete thickness must be a minimum of 3 times the embedment depth of the fastener or 2 inches, whichever is greater. Consideration of smaller spacing and edge distances may be given based on application or jobsite testing.
- The tabulated allowable load values are for the fastener only. Wood or steel members connected to the steel substrate must be investigated in accordance with accepted design criteria.
- Allowable load capacities are calculated using minimum required safety factors in accordance with ICC-ES AC70; the applied safety factor for the tabulated allowable loads is 5.0. Consideration of additional safety factors may be necessary depending on the application such as life safety.
- Multiple fasteners are recommended for any attachment for increased reliability.

**Allowable Loads for CCN Fasteners Driven into Minimum 3,000 psi Sand-Lightweight Concrete and Sand-Lightweight Concrete over Steel Deck<sup>1,5,6,7,8</sup>**

Shank Type	Shank Diameter (inch)	Minimum Embedment (inch)	Installed Directly into Concrete <sup>2</sup>		Installed Through 3-inch Deep Steel Deck Panel into Concrete <sup>3</sup>				Installed Through 1-1/2 -inch Deep Steel Deck Panel into Concrete <sup>4</sup>				Top Cover (inches)
			Tension (lbs)	Shear (lbs)	Tension (lbs)		Shear (lbs)		Tension (lbs)		Shear (lbs)		
					Upper Flute	Lower Flute	Upper Flute	Lower Flute	Upper Flute	Lower Flute	Upper Flute	Lower Flute	
Straight	0.102	3/4	145	160	125	105	260	240	105	105	245	240	2
Tapered	0.120	5/8	120	140	95	80	205	185	100	90	205	200	2

For SI: 1 lbf = 4.48 N, 1 inch = 25.4mm, 1 psi = 6.895 kPa

- Fasteners must not be driven until the concrete has reached the tabulated compressive strength.
- For straight shank fasteners installed directly into concrete (e.g. top of concrete deck), fastener edge distance must be 3.25 inches minimum and fastener spacing must be 4 inches minimum. Fastener spacing must be a minimum of 4 inches for straight shank fasteners and a minimum of 3.25 inches for tapered shank fasteners.
- The steel deck must have a minimum base material thickness of 0.035 inch, minimum yield strength, F<sub>y</sub>, of 33 ksi, minimum tensile strength of 45 ksi and conform to the profile requirements of Figure 1. Fastener edge distance (lower flute locations) must be a minimum of 1-1/8 inches. Fastener spacing must be a minimum of 4 inches for straight shank fasteners and a minimum of 3.25 inches for tapered shank fasteners. Consideration of smaller spacing and edge distances may be given based on application or jobsite testing.
- The steel deck must have a minimum base material thickness of 0.035 inch, minimum yield strength, F<sub>y</sub>, of 33 ksi, minimum tensile strength of 45 ksi and conform to the profile requirements of Figure 2. Fasteners may be installed in an inverted deck profile provided the requirements of the fastener installation locations are followed. Fastener edge distance (lower flute locations) must be a minimum of 7/8 inch. Fastener spacing must be a minimum of 4 inches for straight shank fasteners and a minimum of 3.25 inches for tapered shank fasteners. Consideration of smaller spacing and edge distances may be given based on application or jobsite testing.
- Embedment is measured from the surface of the steel deck; the steel deck panel must have a base-metal thickness of 0.030-inch (22 gauge) to 0.048-inch (18 gauge). Consideration for the thickness of the material fastened to the base material must be given to achieve the required embedment for the fasteners.
- The tabulated allowable load values are for the fastener only. Wood or steel members connected to the steel substrate must be investigated in accordance with accepted design criteria.
- Allowable load capacities are calculated using minimum required safety factors in accordance with ICC-ES AC70; the applied safety factor for the tabulated allowable loads is 5.0. Consideration of additional safety factors may be necessary depending on the application such as life safety.
- Multiple fasteners are recommended for any attachment for increased reliability.

**Figure 1 - Fastener Installation Through Soffit of 3-inch Deep Concrete-filled Composite Steel Deck Floor and Roof Assemblies**

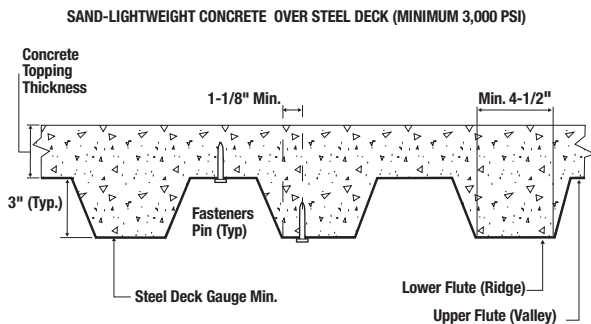

**Figure 2 - Fastener Installation Through the Soffit of 1-1/2 inch Deep Concrete-filled Composite Steel Deck Floor and Roof Assemblies**

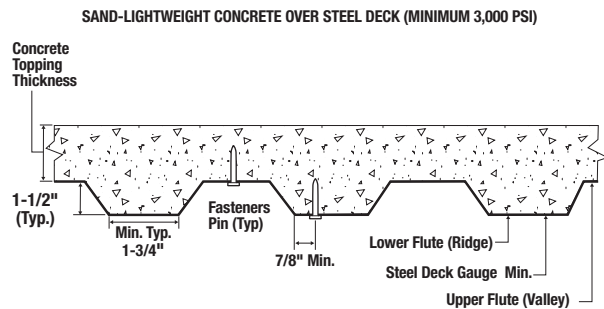

**Allowable Loads for CCN Fasteners Driven into Concrete Masonry Units<sup>1,2,3,4,5,6</sup>**

Shank Type	Shank Diameter (inch)	Minimum Embedment (inch)	Minimum Edge Distance (inch)	Hollow CMU				Grouted CMU					
				Face Shell		Mortar Joint		Face Shell		Mortar Joint		Top of Grouted Cell	
				Tension (lbs)	Shear (lbs)	Tension (lbs)	Shear (lbs)	Tension (lbs)	Shear (lbs)	Tension (lbs)	Shear (lbs)	Tension (lbs)	Shear (lbs)
Straight	0.102	7/8	3-3/4	70	145	55	115	85	110	60	100	140	120
	0.145	3/4	3-3/4	105	65	65	55	-	-	-	-	-	-
Tapered	0.102	5/8	3-3/4	65	45	60	80	60	70	60	80	135	100
			2	65	45	-	-	60	70	-	-	-	-

For St: 1 lbf = 4.48 N, 1 inch = 25.4mm, 1 psi = 6.895 kPa

- Concrete masonry units must be minimum lightweight units conforming to ASTM C90. The minimum nominal size of the CMU must be 8 inches high by 8 inches wide by 16 inches long, with a minimum 1-1/4 -inch-thick face shell thickness.
- Fasteners must be installed a minimum of 1-1/4 inches from the vertical mortar joints. Allowable loads for fasteners installed in vertical mortar joints is outside the scope of this data.
- For straight shank fasteners, minimum fastener spacing is 4 inches center-to-center. For tapered shank fasteners, minimum fastener spacing is 2 inches center-to-center.
- Shear loads for fasteners installed in the face shell or top of grouted cells can be applied in any direction. Shear direction can be horizontal or vertical along the CMU wall plane.
- The allowable tension and shear values are for the fasteners only. Members connected to the concrete masonry must be investigated in accordance with accepted design criteria.
- Allowable load capacities are calculated using minimum required safety factors in accordance with ICC-ES AC70; the applied safety factor for the tabulated allowable loads is 5.0. Consideration of additional safety factors may be necessary depending on the application such as life safety.

**Allowable Loads for CCN Fasteners in Steel<sup>1,5</sup>**

Shank Type	Shank Diameter (inch)	Minimum Spacing (inch)	Minimum Edge Distance (inch)	Allowable Loads In ASTM A36/A1101 Steel						Allowable Loads ASTM A572 Grade 50 or ASTM A992 Steel					
				1/4 <sup>2</sup>		3/8 <sup>3</sup>		1/2 <sup>2,4</sup>		1/4 <sup>2</sup>		3/8 <sup>3</sup>		1/2 <sup>1</sup>	
				Tension (lbs)	Shear (lbs)	Tension (lbs)	Shear (lbs)	Tension (lbs)	Shear (lbs)	Tension (lbs)	Shear (lbs)	Tension (lbs)	Shear (lbs)	Tension (lbs)	Shear (lbs)
Tapered (1/2-inch-long steel pin)	0.120	1	1/2	170	315	165	265	155	220	185	340	165	270	160	230

For St: 1 lbf = 4.48 N, 1 inch = 25.4mm, 1 psi = 6.895 kPa

- Steel base material must have minimum yield and tensile strengths (F<sub>y</sub> and F<sub>u</sub>) equal to 36 ksi and 58 ksi, respectively for A36/A1101 steel and equal to 50 ksi and 65 ksi, respectively for A572 Grade 50 or A992 steel.
- Fasteners must be driven to where the full point length of the fastener penetrates through the steel base material.
- Fastener point penetration is not necessary provided a minimum embedment depth of 0.295 inch is achieved.
- Fastener point penetration is not necessary provided a minimum embedment depth of 0.295 inch is achieved. Allowable load value applies to steel base material with thickness of 1/2 inch and greater.
- Allowable load capacities are calculated using minimum required safety factors in accordance with ICC-ES AC70; the applied safety factor for the tabulated allowable loads is 5.0. Consideration of additional safety factors may be necessary depending on the application such as life safety.
- Multiple fasteners are recommended for any attachment for increased reliability.

**Allowable Tensile Pull-Over Strengths for Light Gauge Steel Framing with CCN Fasteners<sup>1,2,3</sup>**

Shank Type	Shank Diameter (inch)	Head Diameter (inch)	16 Gauge	18 Gauge	20 Gauge	22 Gauge	25 Gauge
			Allowable (lbs)	Allowable (lbs)	Allowable (lbs)	Allowable (lbs)	Allowable (lbs)
			Straight	0.102	0.25	335	270
0.145	0.25	335		270	200	170	120
Tapered	0.120	0.25	335	270	200	170	120

- Tabulated pull-over strengths were calculated in accordance with ICC-ES AC70 and AISI S100-12. Allowable load values are based on a safety factor of 3.0.
- Allowable pullover capacities of sheet steel or framing member should be compared to the fastener tensile capacity in concrete, masonry or steel to determine the controlling resistance load.
- Sheet steel or framing member with tensile strength of 45 ksi assumed for calculating tabulated values.

**STICK-E ASSEMBLIES - SELECTION GUIDE AND PERFORMANCE DATA**<sup>1,2,3,4,5,6,7,8</sup>

Trade / Contractor	Application	Stick-E Accessory		Stick-E and Fastener			Fastener	
		Cat. No.	Description	Suitable Base Material	Allowable Load lbs.	Min. Pin Embed. in.	Shank Dia. x Length in.	CCN System Pin Cat. No.
Plasterer & Insulator	Installing wire lath for stucco or surfacing applications	DFD405101	Lathing Washer 1"	Concrete	60	5/8	0.102 x 3/4 or 0.102 x 0.780 (K)	DCN890075 or DCN8907804
			Hollow/Grouted Block (CMU)	55	5/8			
	Attaching rigid exterior foam insulation	DFD405716	Insulation Washer 1-7/16"	Concrete	30	5/8	0.102 x 1-1/4	DCN890125
			Hollow/Grouted Block (CMU)	30	5/8			
	Attaching DensGlass® board	DFD405901	Denz Glass Washer 1-1/4"	Light Gauge Steel Framing	15 20	18 gauge 16 gauge	0.108 x 1-3/8 (K)	DCN89041380
Electrical	Attaching 3/8" Dia. flexible BX cable	DFD405338	BX Clip 3/8"	Concrete	10	5/8	0.102 x 3/4 or 0.102 x 0.780 (K)	DCN890075 or DCN8907804
				Hollow/Grouted Block (CMU)	10	5/8		
	Attaching 1/2" diameter conduit	DFD405312R	Conduit Clip 1/2"	Concrete	10	5/8		
				Hollow/Grouted Block (CMU)	10	5/8		
	Attaching 3/4" diameter conduit	DFD405334R	Conduit Clip 3/4"	Concrete	10	5/8		
				Hollow/Grouted Block (CMU)	10	5/8		
	Attaching 1" diameter conduit	DFD405310R	Conduit Clip 1"	Concrete	10	5/8		
				Hollow/Grouted Block (CMU)	10	5/8		
	Hanging 1/2" diameter conduit	DFD405412	Mini Conduit Clamp 1/2"	Concrete	10	5/8		
Hanging 3/4" diameter conduit	DFD405434	Mini Conduit Clamp 3/4"	Concrete	10	5/8			
Hanging 1" diameter conduit	DFD405410	Mini Conduit Clamp 1"	Concrete	10	5/8			
	For temporary lighting or wire strapping (using zip-tie or velcro)	DFD405902	Cable Tie Donut 1-1/4"	Concrete	10	5/8		
Mechanical & Electrical	Attaching pencil rod, hooks & wire assemblies	DFD405550	Right Angle Clip 90°	Concrete	75	5/8	0.102 x 3/4 or 0.102 x 0.780 (K)	DCN890075 or DCN8907804
	Attaching pencil rod, hooks & wire assemblies	DFD405530	Angle Clip 60°	Concrete	75	5/8		
	Hanging 1/4" threaded rod	DFD405214	Rod Hanger 1/4"	Concrete	75	5/8		
	Hanging 3/8" threaded rod	DFD405238	Rod Hanger 3/8"	Concrete	75	5/8		
	Hanging 1/4" threaded rod	DFD405215	Post Nut Rod Hanger 1/4"	Concrete	75	5/8		
	Hanging 3/8" threaded rod	DFD405239	Post Nut Rod Hanger 3/8"	Concrete	75	5/8		
Sheet Metal	Attach duct straps to suspend HVAC	DFD405112	Strap Mtl Washer 1/2"	Concrete	50	5/8	0.102 x 3/4 or 0.102 x 0.780 (K)	DCN890075 or DCN8907804
Concrete	Attaching #3 rebar/dowels or wire baskets	DFD405300	Rebar/Dowel Basket Clip	Concrete	50	5/8	0.102 x 3/4 or 0.102 x 0.780 (K)	DCN890075 or DCN8907804

DensGlass is a registered trademark of Georgia-Pacific.  
K = Knurled

- Fasteners installed into concrete or concrete masonry block must not be driven until the base material has reached the minimum specified compressive strength. Embedment is measured from the surface of the base material to the end of the fastener.
- For fasteners installed into concrete, the member thickness must be a minimum of 3 times the embedment depth of the fastener or 2 inches, whichever is greater.
- For installations into concrete or concrete masonry block, minimum fastener edge and end distance is 3-3/4 inches; minimum fastener spacing is 4 inches center-to-center.
- For installations into concrete masonry block, fasteners may be installed into the face shell or horizontal mortar joint. The face shell thickness of hollow concrete masonry block must be 1-1/4 inch minimum. Fasteners must be installed a minimum of 1-1/4 inch from the vertical mortar joints; allowable loads for fasteners installed in vertical mortar joints is outside the scope of this data.
- Allowable load capacities for concrete are based on a minimum concrete compressive strength of 3000 psi; allowable load capacities in concrete may be increased by 15 percent for installations into 4000 psi concrete and allowable load capacities must be reduced by 10 percent for installations into 2500 psi concrete. Allowable load capacities for concrete masonry block are based on a minimum masonry compressive strength of 2000 psi.
- Allowable load capacities for concrete and concrete masonry block are calculated using minimum required safety factors in accordance with ICC-ES AC70; the applied safety factor for the tabulated allowable loads is 5.0. Consideration of additional safety factors may be necessary depending on application such as life safety.
- Allowable loads for light gauge steel framing are calculated using minimum required safety factors in accordance ICC-ES AC259 using light gauge steel framed panels sheathed with DensGlass; the applied safety factor for the tabulated allowable loads is 3.0. Light gauge steel framing members must be minimum 18 gauge thickness. Allowable negative (outward) transverse pressure on the panels must not exceed 15 psf for the specified sheathing thickness, maximum steel stud spacing and fastener spacing. Consideration of additional safety factors may be necessary depending on the applicable design method and/or the application such as life safety. Wood members and/or other proprietary materials connected to the light gauge steel substrate must be investigated for compliance with the applicable codes.
- Multiple fasteners are recommended for any attachment for increased reliability.

**ORDERING INFORMATION**

**CCN Concrete Fasteners**

Cat. No.	Shank Dia. in.	Length in.	Finish	Typical Applications	Box	Ctn.
DCN890075	0.102	3/4	Zinc	Metal track to concrete	1000	6
DCN890100	0.102	1	Zinc	Metal track to concrete	1000	6
DCN890125	0.102	1-1/4	Zinc	Fixture to concrete or block	1000	6
DCN890150	0.102	1-1/2	Zinc	Fixture to concrete or block	1000	6
DCN8912075	0.120	3/4	Zinc	Metal track to concrete or block	1000	6
DCN891075	0.145	3/4	Zinc	Metal track to concrete	1000	6
DCN890225	0.137	2-1/4	Zinc	2x wood to concrete	500	6

Fasteners have a head diameter of 0.25-inch and zinc plated according to ASTM B695, Class 5.

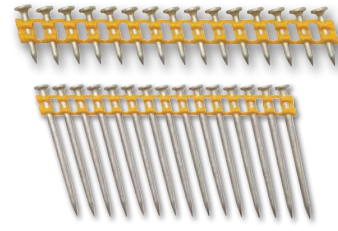

**CCN Steel Fasteners**

Cat #	Shank Dia. in.	Length in.	Finish	Typical Applications	Box	Ctn.
DCN8910500	0.120	1/2	Zinc	Metal track to steel	1000	6

Fasteners have a head diameter of 0.25-inch and zinc plated according to ASTM B695, Class 5.



**CCN Specialty Fasteners**

Cat #	Shank Dia. in.	Step Dia. in.	Length in.	Knurl (K)	Finish	Typical Applications	Box	Ctn.
DCN8941380	0.108	-	1-3/8	Yes	Zinc	Plywood / Fiberglass gypsum sheathing to steel stud	1000	6
DCN8910680	0.120	0.102	0.680	-	Yellow Zinc	Metal track to steel or hard concrete	1000	6
DCN8917300	0.120	0.102	0.730	-	Yellow Zinc	1/4" plywood, furring strip to steel or hard concrete	1000	6
DCN8907804	0.102	0.088	0.780	Yes	Zinc	Steel, studs, precast concrete, block, Stick-E accessories	1000	6

Fasteners have a head diameter of 0.25-inch and zinc plated according to ASTM B695, Class 5.



**Tools and Accessories**

Cat #	Description	Box	Ctn.
DCN890B	Cordless Concrete Nailer (Bare Tool), 2-1/4" Long Pin Capacity DCN8904 Standard/Drywall Contact Trip, Kit Box	1	-
DCN890P2	Cordless Concrete Nailer (Kit), 2-1/4" Long Pin Capacity Two 20V* MAX Premium Lithium Ion Batteries (5Ah), Charger DCN8904 Standard/Drywall Contact Trip, Kit Box	1	-
DCN891B	20V MAX* Magazine Cordless Concrete Nailer (Bare Tool) DCN891 20V MAX* Cordless Concrete Nailer, DCN8907 1" Magazine DCN8905 Standard / Drywall Nose Piece, Kit Box	1	-
DCN891P2	20V MAX* Cordless Concrete Nailer (KIT) DCN891 20V MAX* Cordless Concrete Nailer, (2) DCB205 20V MAX* XR Lithium Ion Batteries (5AH), DCN8907 1" Magazine, DCN8905 Standard / Drywall Nose Piece, Charger, Kit Box	1-	-
DCN8901	Replacement Driver Blade	10	4
DCN8902	Magnetic Stick-E™ Contact Trip (nosepiece)	10	4
DCN8903	Stick-E™ Contact Trip (nosepiece)	10	4
DCN8904	Standard / Drywall Contact Trip (nosepiece)	10	4
DCN8905	6' Pole Tool (for Cordless Concrete Nailer only) (pole tool can be used as 3' or 6' extension)	1	3
DCN8906	2-1/4" Deep Tool Magazine	1	-
DCN8907	1" Deep Tool Magazine	1	-



**CORDLESS FASTENING**

**CORDLESS CONCRETE NAILER (CCN)**  
Gas-Free Fastening System

**Stick-E Assemblies**

Cat. No.	Description	Ctn Qty.	Mstr Qty.
DFD405101	Stick-E Lathing Washer 1"	100	1000
DFD405100	Lathing Washer (No Stick-E)	100	1000
DFD405716	Stick-E Insulation Washer 1-7/16"	100	1000
DFD405901	Stick-E Denz Glass Washer 1-1/4"	250	1000
DFD405338	Stick-E BX Clip 3/8"	100	1000
DFD405412	Stick-E Conduit Clamp 1/2"	50	200
DFD405434	Stick-E Conduit Clamp 3/4"	50	200
DFD405410	Stick-E Conduit Clamp 1"	50	100
DFD405312R	Stick-E Mini Conduit Clip 1/2"	100	1000
DFD405334R	Stick-E Mini Conduit Clip 3/4"	100	1000
DFD405310R	Stick-E Mini Conduit Clip 1"	100	1000
DFD405902	Stick-E Cable Tie Donut 1-1/4"	100	1000
DFD405550	Stick-E Right Angle Clip 90°	100	1000
DFD405530	Stick-E Angle Clip 60°	100	1000
DFD405214	Stick-E Rod Hanger 1/4"-20	100	1000
DFD405238	Stick-E Rod Hanger 3/8"-16	100	1000
DFD405215	Stick-E Post Nut Rod Hanger 1/4"-20	100	1000
DFD405239	Stick-E Post Nut Rod Hanger 3/8"-16	100	1000
DFD405112	Stick-E Strap Mtl Washer 1/2"	100	1000
DFD405300	Stick-E Rebar/Dowel Basket Clip	100	1000
DFD405610	Stick-E Square Washer 1"	100	1000
DFD405102	Stick-E SS Sealing Washer 3/4"	100	1000

Angle clips are 3/4-inch wide and 2mm thick with a 5/16-inch wire hole.  
Rebar/dowel basket clips are sized to accept #3 rebar and 3/8-inch dowels.



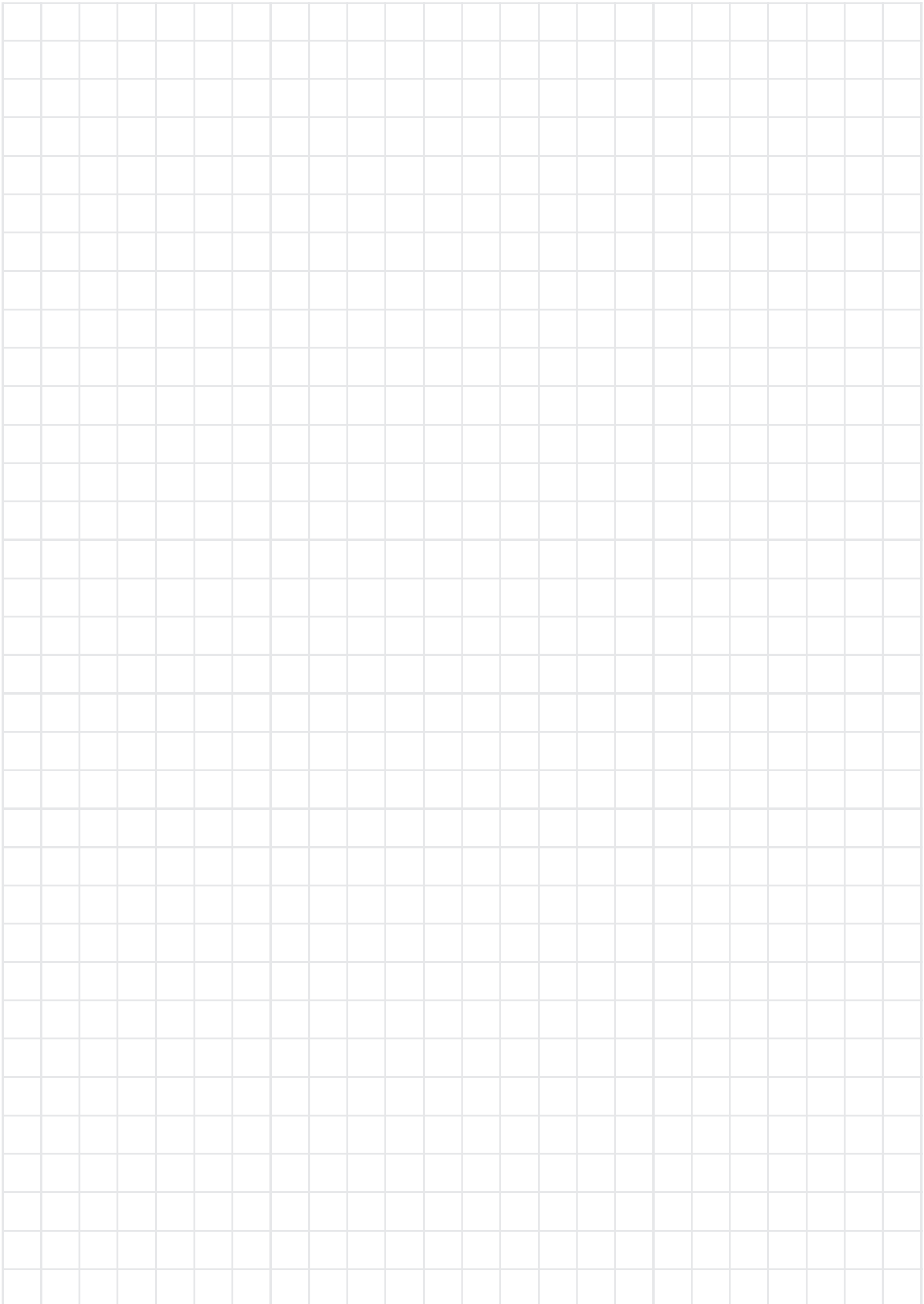

**GAS DIRECT FASTENING SYSTEMS**







<b>SELECTION GUIDE</b>	56
<b>GAS TOOLS</b>	
<b>TRAK-IT® C5 TOOL</b>	57
<b>GAS FASTENERS</b>	
<b>PINS FOR CONCRETE &amp; CONCRETE MASONRY</b>	58
<b>PINS FOR STEEL</b>	58
<b>SPECIALTY PINS</b>	58
<b>GAS ASSEMBLIES</b>	
<b>STICK-E ASSEMBLIES</b>	61
<b>GAS ACCESSORIES</b>	
<b>TRAK-IT® C5 PARTS/ATTACHMENTS</b>	63

### GAS DIRECT FASTENING SELECTION GUIDE

Pins / Fasteners Description	Dimensions		Base Material						Stick-E Accessories	Approvals & Listings
	Shank Diameter	Shank Length	Concrete	Lightweight Concrete	Concrete over Steel Deck	Concrete Masonry (CMU)	Steel	Light Gauge Steel		
<b>Trak-It C5</b> Straight Shank Pins	0.102"	3/4" to 1-1/2"	●	●	●	●			●	ESR-3275
Tapered Shank Pins	0.120"	1/2"					●			ESR-3275
Tapered Shank Pins	0.120"	3/4"	●	●	●	●				ESR-3275
Straight Shank Pins	0.145"	3/4" to 1"	●	●	●	●				ESR-3275
Step Shank Pins	0.145"/0.102"	1-1/4" to 1-1/2"	●	●	●	●				ESR-3275
Step Shank Pins	0.145"/0.120" (K)	1" to 1-1/4"	●	○		●	●			ESR-3275
Step Shank Pins	0.120/0.102" (K)	0.680" to 0.730"	●	○			●			ESR-3275
Step Shank Pins	0.102/0.088" (K)	0.780"	●	○	○	●	○		●	
Spiral Shank Pin	0.108" (K)	1-3/8"						●	Denz Glass Washer	

● Suitable ○ May be Suitable  
(K) = Knurled

**GENERAL INFORMATION**

**TRAK-IT® C5**

*Gas Fastening System*

**PRODUCT DESCRIPTION**

The Trak-It C5 gas fastening system was developed for use in light-duty applications, including attaching drywall track to concrete, lightweight concrete, block or steel. Also can be considered for fastening lath to concrete or block, furring strips to concrete or block, and plywood to concrete or block base materials. The system is designed for speed, efficiency and consistency. Operation of a gas fastening system does not require licensing.

Stick-E assemblies are specially designed components for various fastening attachments into concrete, concrete masonry block and steel.

**GENERAL APPLICATIONS AND USES**

- Attaching light gauge steel track to concrete, concrete masonry block (CMU) or steel
- Attaching plywood to concrete or concrete masonry block (CMU)
- Attaching lath to concrete, concrete masonry block (CMU) or steel
- Attaching furring strips to concrete or concrete masonry block (CMU)
- Attaching Stick-E assemblies to concrete and concrete masonry block (CMU)

**FEATURES AND BENEFITS**

- + No licensing requirements
- + Each fuel cell contains enough gas to install up to 800 fasteners
- + Available for use with Stick-E™ accessories
- + Tracks are easily removed and exchanged on tool
- + Adjustable depth control on tool nose piece
- + Maintenance counter and LED indicator
- + Dust and corrosion resistant tool manifolds
- + Ergonomic handle with light trigger pull load
- + Can be used with a C5 pole tool

**APPROVALS AND LISTINGS**

- International Code Council, Evaluation Service (ICC-ES), ESR-3275
- Code compliant with the 2018 IBC/IRC, 2015 IBC/IRC, 2012 IBC/IRC, and 2009 IBC/IRC
- Tested in accordance with ASTM E1190 and ICC-ES AC70 for use in concrete, CMU block and steel

**GUIDE SPECIFICATIONS**

CSI Divisions: 03 15 00 - Concrete Accessories, 05 05 23 - Metal Fastenings, 06 05 23 - Wood, Plastic and Composite Fastenings, 09 22 16.23 - Fasteners. Power-driven fasteners shall be Trak-It C5 as supplied by DEWALT / Powers, Towson, MD.

**TOOL SPECIFICATIONS**

**Trak-It C5 Tool**

<b>Tool Body</b>	Precision Moulded Aluminum and Plastic
<b>Tool Length</b>	17.25"
<b>Tool Weight</b>	7.9 lbs
<b>Pin Length (Maximum)</b>	1-1/4" for deep track; 1-1/2" for short track & long track
<b>Pin Capacity</b>	42 pins for deep track & long track; 22 pins for short track
<b>Power Capacity</b>	105 joules
<b>Approximate Shots per Fuel Cell</b>	800 pins
<b>Approximate Shots per Battery Charge</b>	5,700

**SECTION CONTENTS**

General Information.....56  
 Performance Data.....57  
 Stick-E Assemblies .....60  
 Ordering Information.....61



TRAK-IT C5 TOOL (SHOWN WITH DEEP TRACK) FOR 1-1/4" PIN LENGTH



SHORT TRACK & LONG TRACK FOR 1-1/2" PIN LENGTH



FASTENERS FOR CONCRETE AND MASONRY



FASTENERS FOR STEEL



SPECIALTY FASTENERS



STICK-E ASSEMBLIES

**SUITABLE BASE MATERIALS**

- Normal-Weight Concrete
- Lightweight Concrete
- Grouted Concrete Masonry (CMU)
- Hollow Concrete Masonry (CMU)
- Steel

**PERFORMANCE DATA**

**Allowable Loads for Trak-It C5 Fasteners Installed in Normal Weight Concrete<sup>1,2,3,9,10</sup>**

Shank Type (inch)	Shank Diameter (inch)	Minimum Embedment (inch)	Minimum Fastener Length <sup>4</sup> (inch)	Minimum Spacing <sup>6</sup> (inch)	Minimum Edge Distance <sup>6</sup> (inch)	Minimum Concrete Compressive Strength (f'c)					
						2,500 psi		3,000 psi		4,000 psi	
						Tension (lbs)	Shear (lbs)	Tension (lbs)	Shear (lbs)	Tension (lbs)	Shear (lbs)
Straight	0.102	5/8	3/4	4	3-1/4	120	135	120	140	120	145
		7/8	1	4	3-1/4	180	185	180	195	180 <sup>7</sup>	215 <sup>7</sup>
	1-1/8	1-1/4	4	3-1/4	240	225	240	255	245	310	
	0.145	5/8	3/4	4	3-1/4	105	75	110	95	120	135
7/8		1	4	3	125	105	135	110	-	-	
Step	0.120/0.102	0.600 <sup>5</sup>	0.680 <sup>5</sup>	4	3	-	-	-	-	90	65
		5/8	0.730	4	3	-	-	-	-	115 <sup>8</sup>	80 <sup>8</sup>
	3/4	1-1/4	4	3	80	215	85	235	85	235	
	0.145/0.102	1	1-1/4	4	3	125	245	135	265	-	-
		1-1/8	1-1/4	4	1-3/4	215	250	250	250	-	-
0.145/0.120	3/4	7/8	4	3-1/4	145	180	155	185	170	190	
Tapered	0.120	5/8	3/4	3-1/4	3-1/4	150	120	170	135	170	145
				2-3/4		150	120	170	135	165	135
				2		150	90	170	100	160	100

For SI: 1 lbf = 4.48 N, 1 inch = 25.4mm, 1 psi = 6.895 kPa

- Fasteners must not be driven until the concrete has reached the tabulated compressive strength.
- Concrete thickness must be a minimum of 3 times the embedment depth of the fastener or 2 inches, whichever is greater.
- The tabulated allowable load values are for the fastener only. Wood or steel members connected to the steel substrate must be investigated in accordance with accepted design criteria.
- Based upon attachment of 16 gauge sheet metal or thinner, except as noted.
- Based upon attachment of 25 gauge sheet metal or thinner.
- Installing fasteners less than the minimum spacing and edge distance values in this table can result in a reduction in capacity. Such conditions are outside the scope of this published information.
- For installations in 6,000 psi concrete, the tabulated tension and shear loads may be increased to 200 lbs and 220 lbs, respectively.
- For installations in 6,000 psi concrete, the tabulated shear load may be increased to 125 lbs. The tabulated tension load must not be increased.
- Allowable load capacities are calculated using minimum required safety factors in accordance with ICC-ES AC70; the applied safety factor for the tabulated allowable loads is 5.0.
- Multiple fasteners are recommended for any attachment for increased reliability.

**Allowable Loads for Trak-It C5 Fasteners Driven into Concrete Masonry Units<sup>1,2,3,7,8,9</sup>**

Shank Type	Shank Diameter (inch)	Min. Embed. Depth (inch)	Min. End and Edge Distance (inches)	Allowable Loads (lbf)									
				Hollow CMU				Grouted CMU					
				Face Shell <sup>6</sup>		Horizontal Mortar Joint		Face Shell <sup>6</sup>		Horizontal Mortar Joint		Top and Center of Grouted Cell	
				Tension	Shear <sup>4</sup>	Tension	Shear <sup>5</sup>	Tension	Shear <sup>4</sup>	Tension	Shear <sup>4</sup>	Tension	Shear <sup>4</sup>
Straight	0.102	7/8	3-3/4	65	80	55	65	65	80	55	65	-	-
	0.145	3/4	3-3/4	-	-	-	-	80	90	-	-	-	-
Step	0.145/0.120	3/4	3-3/4	-	-	-	-	85	100	-	-	-	-
	0.145/0.102	1-1/8	3-3/4	-	-	-	-	180	215	-	-	-	-
Tapered	0.120	5/8	3-3/4	45	65	60	80	60	70	60	80	135	100
			2			-	-			-	-	-	-

For SI: 1 lbf = 4.4 N, 1 inch = 25.4 mm.

- Concrete masonry units must be normalweight units conforming to ASTM C90. The minimum allowable nominal size of the CMU must be 8 inches high by 8 inches wide by 16 inches long, with a minimum, 1-1/4-inch-thick face shell thickness.
- Straight shank and step shank fasteners must only be placed into the unit face, including ends of masonry units. Only one straight shank or step shank fastener may be installed in each cell, and it must be a minimum of 1-1/2 inches from the mortar joints and 1-1/2 inches from the CMU web.
- For tapered shank fasteners, minimum fastener spacing is 2 inches center-to-center.
- Shear loads for straight shank and step shank fasteners installed in the face shell (including ends of masonry units) may be applied in any direction. Shear loads for tapered shank fasteners installed in the face shell (including ends of masonry units) or in the top of grouted cells may be applied in any direction.
- Shear loads for tapered shank fasteners installed into the horizontal mortar joint may be applied in any direction along the CMU wall plane.
- Installations in the face shell of the wall are applicable for fasteners in the ends of masonry units where the minimum edge and end distances are maintained.
- Fasteners must not be installed into vertical mortar joints, including the intersection of the head joint and bed joint. Fasteners with a straight shank and step shank must be installed a minimum of 3-3/4 inches from the vertical mortar joints. Fasteners with a tapered shank must be installed a minimum of 1-1/4 inches from the vertical mortar joints.
- Allowable load capacities are calculated using minimum required safety factors in accordance with ICC-ES AC70; the applied safety factor for the tabulated allowable loads is 5.0.
- Multiple fasteners are recommended for any attachment for increased reliability.

Fasteners Installed into Hollow or Grout-Filled Concrete Masonry Units

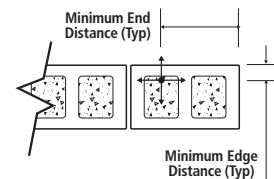
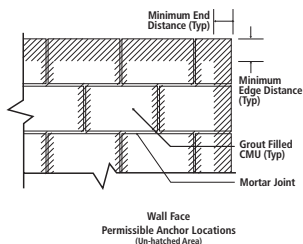

Top of Wall

**Allowable Loads for Trak-It C5 Fasteners Installed in ASTM A36 Steel<sup>1,2,7,8</sup>**

Shank Type	Shank Diameter (inch)	Minimum Spacing (inch)	Minimum Edge Distance (inch)	Steel Thickness (inch)									
				1/8		3/16		1/4		3/8		1/2	
				Tension (lbs)	Shear (lbs)	Tension (lbs)	Shear (lbs)	Tension (lbs)	Shear (lbs)	Tension (lbs)	Shear (lbs)	Tension (lbs)	Shear (lbs)
Step	0.120/0.102	1	1/2	115	280	230	280	250	240	165 <sup>3</sup>	125 <sup>3</sup>	220 <sup>4</sup>	205 <sup>4</sup>
	0.145/0.120	1	1/2	95	300	285	300	225	190	-	-	-	-
Tapered	0.120	1	1/2	-	-	-	-	130	230	215 <sup>5</sup>	325 <sup>5</sup>	185 <sup>6</sup>	325 <sup>6</sup>

For St: 1 lbf = 4.48 N, 1 inch = 25.4mm, 1 psi = 6.895 kPa

- Steel base material must have minimum yield and tensile strengths (F<sub>y</sub> and F<sub>u</sub>) equal to 36 ksi and 58 ksi, respectively.
- Unless otherwise noted, fasteners must be driven to where the point of the fastener penetrates through the steel base material.
- An embedment depth of 0.350-inch is required for the tabulated value. Allowable load value applies to steel base material with a thickness of 3/8-inch and thickness up to but not including 1/2-inch. For cases where the embedment depth is less than 0.350-inch but at least 0.250-inch, the allowable tension load is 115 lbs and the allowable shear is 120 lbs.
- An embedment depth of 0.375-inch is required for the tabulated value. Allowable load value applies to steel base material with a thickness of 1/2-inch or greater. For cases where the embedment depth is less than 0.375-inch, but is at least 0.350-inch, the allowable tension load is 165 lbs and the allowable shear load is 125 lbs. For cases where the embedment depth is less than 0.350-inch but at least 0.250-inch, the allowable tension load is 110 lbs and the allowable shear is 120 lbs.
- An embedment depth of 0.350 inch is required. Allowable load value applies to steel base material with thickness of 3/8 inch and thicknesses up to but not including 1/2 inch.
- An embedment depth of 0.340 inch is required for the tabulated value. Allowable load value applies to steel base material with thickness of 1/2 inch and greater.
- Allowable load capacities are calculated using minimum required safety factors in accordance with ICC-ES AC70; the applied safety factor for the tabulated allowable loads is 5.0.
- Multiple fasteners are recommended for any attachment for increased reliability.

**Allowable Loads for Trak-It C5 Fasteners Installed in ASTM A572 Grade 50 or ASTM A992 Steel<sup>1,2,7,8</sup>**

Shank Type	Shank Diameter (inch)	Minimum Spacing (inch)	Minimum Edge Distance (inch)	Steel Thickness (inch)									
				1/8		3/16		1/4		3/8		1/2	
				Tension (lbs)	Shear (lbs)	Tension (lbs)	Shear (lbs)	Tension (lbs)	Shear (lbs)	Tension (lbs)	Shear (lbs)	Tension (lbs)	Shear (lbs)
Step	0.120/0.102	1	1/2	120	290	245	290	270	255	175 <sup>3</sup>	135 <sup>3</sup>	240 <sup>4</sup>	220 <sup>4</sup>
	0.145/0.120	1	1/2	100	320	305	320	245	205	-	-	-	-
Tapered	0.120	1	1/2	-	-	-	-	140	250	215 <sup>5</sup>	325 <sup>5</sup>	195 <sup>6</sup>	340 <sup>6</sup>

For St: 1 lbf = 4.48 N, 1 inch = 25.4mm, 1 psi = 6.895 kPa

- Steel base material must have minimum yield and tensile strengths (F<sub>y</sub> and F<sub>u</sub>) equal to 50 ksi and 65 ksi, respectively.
- Unless otherwise noted, fasteners must be driven to where the point of the fastener penetrates through the steel base material.
- An embedment depth of 0.350-inch is required for the tabulated value. Allowable load value applies to steel base material with a thickness of 3/8-inch and thickness up to but not including 1/2-inch. For cases where the embedment depth is less than 0.350-inch but at least 0.188-inch, the allowable tension load is 65 lbs and the allowable shear is 90 lbs.
- An embedment depth of 0.375-inch is required for the tabulated value. Allowable load value applies to steel base material with a thickness of 1/2-inch or greater. For cases where the embedment depth is less than 0.375-inch, but is at least 0.350-inch, allowable tension load is 175 lbs and the allowable shear load is 135 lbs. For cases where the embedment depth is less than 0.350-inch but at least 0.125-inch, the allowable tension load is 25 lbs and the allowable shear is 55 lbs.
- An embedment depth of 0.350 inch is required. Allowable load value applies to steel base material with thickness of 3/8 inch and thicknesses up to but not including 1/2 inch.
- An embedment depth of 0.340 inch is required for the tabulated value. Allowable load value applies to steel base material with thickness of 1/2 inch and greater.
- Allowable load capacities are calculated using minimum required safety factors in accordance with ICC-ES AC70; the applied safety factor for the tabulated allowable loads is 5.0.
- Multiple fasteners are recommended for any attachment for increased reliability.

**Allowable Loads for Trak-It C5 Spiral Knurl Pin Installed into Steel<sup>1,2,3</sup>**

Fastener Type (Style)	Shank Diameter (inch)	16 Gauge Steel		18 Gauge Steel		20 Gauge Steel	
		Tension (lbs)	Shear (lbs)	Tension (lbs)	Shear (lbs)	Tension (lbs)	Shear (lbs)
Spiral Knurl Pin	0.108 (K)	45	140	30	90	20	60

- Tested in accordance with general provisions of ASTM E1190 / ICC-ES AC70 and with steel members meeting ASTM C955/A653. Allowable loads are calculated using an applied safety factor of 5.0. Consideration of safety factors of 10 or higher may be necessary depending on the application, such as life safety.
- The tabulated allowable load values are for the fastener pullout capacity in the steel member. Wood members and/or proprietary materials (e.g. sheathing) connected to the steel must be investigated in accordance with the applicable code(s).
- Multiple fasteners are recommended for any attachment for increased reliability.

**Allowable Tensile Pull-Over Strengths for Light Gauge Steel Framing with Trak-It C5 Fasteners<sup>1,2,3</sup>**

Shank Type	Shank Diameter (inch)	Head Diameter (inch)	16 Gauge	18 Gauge	20 Gauge	22 Gauge	25 Gauge
			Allowable (lbs)	Allowable (lbs)	Allowable (lbs)	Allowable (lbs)	Allowable (lbs)
Straight	0.102	0.25	335	270	200	170	120
	0.145	0.25	335	270	200	170	120
Tapered	0.120	0.25	335	270	200	170	120

- Tabulated pull-over strengths were calculated in accordance with ICC-ES AC70 and AISI S100-12. Allowable load values are based on a safety factor of 3.0.
- Allowable pullover capacities of sheet steel or framing member should be compared to the fastener tensile capacity in concrete, masonry or steel to determine the controlling resistance load.
- Sheet steel or framing member with tensile strength of 45 ksi assumed for calculating tabulated values.

### Allowable Loads for Trak-It C5 Fasteners Driven into Minimum 3,000 psi Sand-Lightweight Concrete and Sand-Lightweight Concrete-Filled Steel Deck<sup>1,5,8,9</sup>

Shank Type	Shank Diameter (inch)	Min. Embed. Depth (inch)	Allowable Loads (lbf)										Top Cover (inches)
			Installed Directly into Concrete <sup>2</sup>		Installed through 3" Deep Steel Deck Panel into Concrete <sup>3</sup>				Installed through 1-1/2" Deep Steel Deck Panel into Concrete <sup>4</sup>				
					Upper Flute	Lower Flute	Upper Flute	Lower Flute	Upper Flute	Lower Flute	Upper Flute	Lower Flute	
			Tension	Shear	Tension		Shear		Tension		Shear		
Straight	0.102	5/8	115 <sup>6</sup>	135 <sup>6</sup>	110 <sup>6</sup>	85 <sup>6</sup>	225 <sup>6</sup>	195 <sup>6</sup>	50 <sup>6</sup>	105 <sup>6</sup>	125 <sup>6</sup>	195 <sup>6</sup>	2
		3/4	120	150	120	105	225	195	115	105	225	195	2-1/4
		7/8	120	205	–	105	–	255	–	–	110	–	245
	0.145	3/4	70	80	110	80	220	200	–	60	–	200	2-1/4
Step	0.145/0.102	1-1/8	280	230	–	160	–	300	–	150	–	300	3-1/4
Tapered	0.120	5/8	120 <sup>6</sup>	140 <sup>6</sup>	95 <sup>6</sup>	80 <sup>6</sup>	205 <sup>6</sup>	185 <sup>6</sup>	100 <sup>6</sup>	90 <sup>6</sup>	205 <sup>6</sup>	200 <sup>6</sup>	2

For SI: 1 lbf = 4.4 N, 1 inch = 25.4 mm, 1 psi = 6.895 kPa.

- Fasteners must not be driven until the concrete has reached the tabulated compressive strength.
- For straight shank and step shank fasteners installed directly into concrete (e.g. top of concrete-filled steel deck), fastener edge distance must be 3 inches minimum and fastener spacing must be 4 inches minimum. For tapered shank fasteners installed directly into concrete (e.g. top of concrete-filled steel deck), fastener edge distance must be 3 inches minimum and fastener spacing must be 3.25 inches minimum. Shear loads may be applied in any direction.
- The steel deck must have a minimum base material thickness of 0.035 inch, minimum yield strength,  $F_y$ , of 33 ksi, a minimum tensile strength of 45 ksi, and conform to the profile requirements as shown in Figure 1. Fastener edge distance (lower flute locations) must be a minimum of 1-1/8 inches. Fastener spacing must be a minimum of 4 inches for straight shank fasteners and a minimum of 3.25 inches for tapered shank fasteners. Shear loads may be applied in any direction.
- The steel deck must have a minimum base material thickness of 0.035 inch, minimum yield strength,  $F_y$ , of 33 ksi, a minimum tensile strength of 45 ksi, and conform to the profile requirements as shown in Figure 1. Fastener edge distance (lower flute locations) must be a minimum of 7/8 inches. Fastener spacing must be a minimum of 4 inches for straight shank fasteners and a minimum of 3.25 inches for tapered shank fasteners.
- Unless otherwise noted, for installation into lightweight concrete with  $f'c = 3,500$  psi, multiply the tabulated values by 1.05 to determine the applicable allowable load value.
- For installation of 0.102-inch-diameter straight shank fasteners and 0.120-inch-diameter tapered shank fasteners into lightweight concrete with  $f'c = 3,500$  psi, no increase in tabulated values is allowed. For installation into lightweight concrete with  $f'c = 2,500$  psi, multiply the tabulated values by 0.87 to determine the applicable allowable load value.
- For fastener installations into the lower flute, the minimum required topping thickness above the deck panel is 2 inches.
- Allowable load capacities are calculated using minimum required safety factors in accordance with ICC-ES AC70; the applied safety factor for the tabulated allowable loads is 5.0.
- Multiple fasteners are recommended for any attachment for increased reliability.

**Figure 1 - Fastener Installation Through Soffit of 3-inch Deep Concrete-filled Composite Steel Deck Floor and Roof Assemblies.**

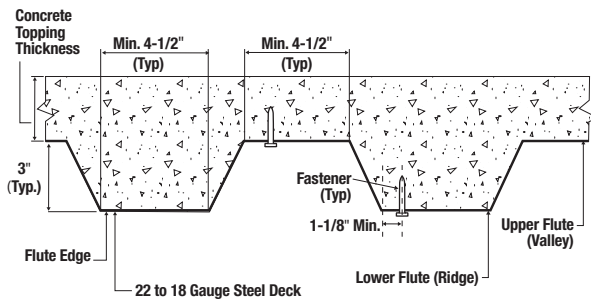

**Figure 2 - Fastener Installation Through the Soffit of 1-1/2 inch Deep Concrete-filled Composite Steel Deck Floor and Roof Assemblies.**

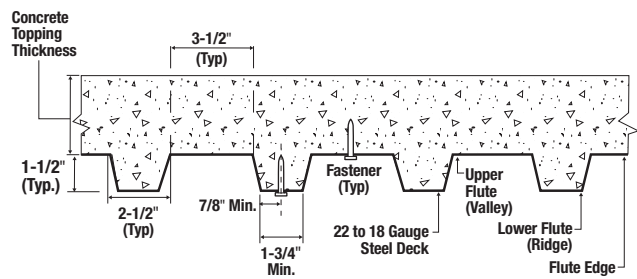

**STICK-E™ DIRECT FASTENING ASSEMBLIES - SELECTION GUIDE AND PERFORMANCE DATA**<sup>1,2,3,4,5,6,7,8</sup>

Trade / Contractor	Application	Stick-E Accessory		Stick-E and Fastener			Fastener	
		Cat. No.	Description	Suitable Base Material	Allowable Load lbs.	Min. Pin Embed. in.	Shank Dia. x Length in.	Trak-It C5 System Pin Cat. No.
Plasterer & Insulator	Installing wire lath for stucco or surfacing applications	DFD405101	Lathing Washer 1"	Concrete	60	5/8	0.102" x 3/4" or 0.102" x 0.780" (K)	55310 or 55341
				Hollow/Grouted Block (CMU)	55	5/8		
	Attaching rigid exterior foam insulation	DFD405716	Insulation Washer 1-7/16"	Concrete	30	5/8	0.102" x 1-1/4"	55341
	Attaching DensGlass® board	DFD405901	Denz Glass Washer 1-1/4"	Light Gauge Steel Framing	15 20	18 gauge 16 gauge	0.108" x 1-3/8" (K)	55340
Electrical	Attaching 3/8" Dia. flexible BX cable	DFD405338	BX Clip 3/8"	Concrete	10	5/8	0.102" x 3/4" or 0.102" x 0.780" (K)	55310 or 55341
	Attaching 1/2" diameter conduit	DFD405312R	Conduit Clip 1/2"	Hollow/Grouted Block (CMU)	10	5/8		
				Concrete	10	5/8		
	Attaching 3/4" diameter conduit	DFD405334R	Conduit Clip 3/4"	Concrete	10	5/8		
				Hollow/Grouted Block (CMU)	10	5/8		
	Attaching 1" diameter conduit	DFD405310R	Conduit Clip 1"	Concrete	10	5/8		
				Hollow/Grouted Block (CMU)	10	5/8		
	Hanging 1/2" diameter conduit	DFD405412	Mini Conduit Clamp 1/2"	Concrete	10	5/8		
Hanging 3/4" diameter conduit	DFD405434	Mini Conduit Clamp 3/4"	Concrete	10	5/8			
Hanging 1" diameter conduit	DFD405410	Mini Conduit Clamp 1"	Concrete	10	5/8			
For temporary lighting or wire strapping (using zip-tie or velcro)	DFD405902	Cable Tie Donut 1-1/4"	Concrete	10	5/8			
Mechanical & Electrical	Attaching pencil rod, hooks & wire assemblies	DFD405550	Right Angle Clip 90°	Concrete	75	5/8	0.102" x 3/4" or 0.102" x 0.780" (K)	55310 or 55341
	Attaching pencil rod, hooks & wire assemblies	DFD405530	Angle Clip 60°	Concrete	75	5/8		
	Hanging 1/4" threaded rod	DFD405214	Rod Hanger 1/4"	Concrete	75	5/8		
	Hanging 3/8" threaded rod	DFD405238	Rod Hanger 3/8"	Concrete	75	5/8		
	Hanging 1/4" threaded rod	DFD405215	Post Nut Rod Hanger 1/4"	Concrete	75	5/8		
	Hanging 3/8" threaded rod	DFD405239	Post Nut Rod Hanger 3/8"	Concrete	75	5/8		
Sheet Metal	Attach duct straps to suspend HVAC	DFD405112	Strap Mtl Washer 1/2"	Concrete	50	5/8	0.102" x 3/4" or 0.102" x 0.780" (K)	55310 or 55341
Concrete	Attaching #3 rebar/dowels or wire baskets	DFD405300	Rebar/Dowel Basket Clip	Concrete	50	5/8	0.102" x 3/4" or 0.102" x 0.780" (K)	55310 or 55341

DensGlass is a registered trademark of Georgia-Pacific.

K = Knurled

- Fasteners installed into concrete or concrete masonry block must not be driven until the base material has reached the minimum specified compressive strength. Embedment is measured from the surface of the base material to the end of the fastener.
- For fasteners installed into concrete, the member thickness must be a minimum of 3 times the embedment depth of the fastener or 2 inches, whichever is greater.
- For installations into concrete or concrete masonry block, minimum fastener edge and end distance is 3-3/4 inches; minimum fastener spacing is 4 inches center-to-center.
- For installations into concrete masonry block, fasteners may be installed into the face shell or horizontal mortar joint. The face shell thickness of hollow concrete masonry block must be 1-1/4 inch minimum. Fasteners must be installed a minimum of 1-1/4 inch from the vertical mortar joints; allowable loads for fasteners installed in vertical mortar joints is outside the scope of this data.
- Allowable load capacities for concrete are based on a minimum concrete compressive strength of 3000 psi; allowable load capacities in concrete may be increased by 15 percent for installations into 4000 psi concrete and allowable load capacities must be reduced by 10 percent for installations into 2500 psi concrete. Allowable load capacities for concrete masonry block are based on a minimum masonry compressive strength of 2000 psi.
- Allowable load capacities for concrete and concrete masonry block are calculated using minimum required safety factors in accordance with ICC-ES AC70; the applied safety factor for the tabulated allowable loads is 5.0. Consideration of additional safety factors may be necessary depending on application such as life safety.
- Allowable loads for light gauge steel framing are calculated using minimum required safety factors in accordance ICC-ES AC259 using light gauge steel framed panels sheathed with DensGlass; the applied safety factor for the tabulated allowable loads is 3.0. Light gauge steel framing members must be minimum 18 gauge thickness. Allowable negative (outward) transverse pressure on the panels must not exceed 15 psf for the specified sheathing thickness, maximum steel stud spacing and fastener spacing. Consideration of additional safety factors may be necessary depending on the applicable design method and/or the application such as life safety. Wood members and/or other proprietary materials connected to the light gauge steel substrate must be investigated for compliance with the applicable codes.
- Multiple fasteners are recommended for any attachment for increased reliability.

**GAS FASTENING**

**TRAK-IT® C5**  
Gas-Free Fastening System

TECH MANUAL – GAS FASTENING ©2019 DEWALT – REV. E

**ORDERING INFORMATION**

**Pins for Concrete and Concrete Masonry (CMU)**

Cat. No.	Shank Dia.	Step Dia.	Length	Shank Type	Finish	Box	Ctn.	Typical Applications
55310	0.102"	-	3/4"	Straight, smooth	Zinc	800	4000	Metal track to concrete
55312	0.102"	-	1"	Straight, smooth	Zinc	800	4000	Metal track to concrete
55314	0.102"	-	1-1/4"	Straight, smooth	Zinc	800	4000	Fixture to concrete or block (CMU)
55316	0.102"	-	1-1/2"	Straight, smooth	Zinc	800	4000	Fixture to concrete or block (CMU)
55318	0.145"	-	3/4"	Straight, smooth	Zinc	800	4000	Metal track to concrete
55320	0.145"	-	1"	Straight, smooth	Zinc	800	4000	Light gauge metal track to concrete, 1/4" & 3/8" plywood to concrete/block, rubber membrane to concrete or block (CMU)
55322	0.145"	0.102"	1-1/4"	Step, smooth	Zinc	800	4000	Fixture to concrete or block (CMU)
55324	0.145"	0.102"	1-1/2"	Step, smooth	Zinc	800	4000	Fixture to concrete or block (CMU)
55343	0.120"	-	3/4"	Tapered, smooth	Zinc	800	4000	Metal track to concrete or block (CMU)

Fasteners have a head diameter of 0.25-inch and zinc plated according to ASTM B695, Class 5.

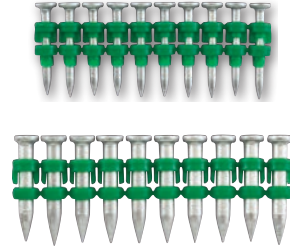

**Pins for Steel**

Cat. No.	Shank Dia.	Step Dia.	Length	Shank Type	Finish	Box	Ctn.	Typical Applications
55325	0.120"	-	1/2"	Straight, smooth	Zinc	800	4000	Metal track to steel
55343	0.120"	-	3/4"	Tapered, smooth	Zinc	800	4000	Metal track to steel

Fasteners have a head diameter of 0.25-inch and zinc plated according to ASTM B695, Class 5.

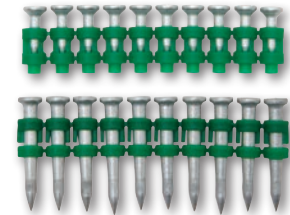

**Specialty Pins**

Cat. No.	Shank Dia.	Step Dia.	Length	Shank Type	Finish	Box	Ctn.	Typical Applications
55328	0.120"	0.102"	0.680"	Step, knurled	Zinc	800	4000	Metal track to steel or concrete
55330	0.120"	0.102"	0.730"	Step, knurled	Zinc	800	4000	1/4" plywood to steel or hard concrete
55340	0.108"	-	1-3/8"	Spiral, knurled	Zinc	800	4000	Plywood and sheathing board (with Denz Glass washer) to light gauge steel stud
55342	0.102"	0.088"	0.780"	Step, knurled	Zinc	800	4000	Steel, stud, precast concrete, block (CMU) and steel
55336	0.145"	0.120"	7/8"	Step, knurled	Zinc	800	4000	1/2" & 5/8" plywood to steel
55338	0.145"	0.120"	1-1/8"	Step, knurled	Zinc	800	4000	3/4" plywood to steel, 1" furring strip to steel

Fasteners have a head diameter of 0.25-inch and zinc plated according to ASTM B695, Class 5.

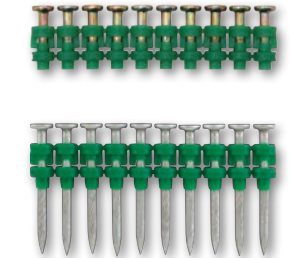



**Tools and Accessories**

Cat. No.	Description	Box Qty.	Ctn Qty.
55142	Trak-It C5 Tool w/ Deep Track (1-1/4" Pin) - 42 Pin Capacity	1	-
55144	Trak-It C5 Tool w/ Short Track (1-1/2" Pin) - 22 Pin Capacity	1	-
55148	Trak-It C5 Tool w/ Long Track (1-1/2" Pin) - 42 Pin Capacity	1	-
55302	Trak-It C5 Fuel Cell	20	80
55583	Trak-It C5 Battery	1	-
55618	Trak-It C5 Charger Base	1	-
55619	Trak-It C5 110V Adapter Cord	1	-
56347	Trak-It C5 Pole Tool Full System	1	3
56348	Trak-It C5 Pole Tool 3' Extension	1	20
56342	Accessory Deep Track for Trak-It C5 (Up to 1-1/4" Pins - 42 Pin Capacity)	1	-
55346	Accessory Short Track for Trak-It C5 (Up to 1-1/2" Pins - 22 Pin Capacity)	1	-
56344	Accessory Long Track for Trak-It C5 (Up to 1-1/2" Pins - 42 Pin Capacity)	1	-



**Stick-E Assemblies**

Cat. No.	Description	Ctn Qty.	Mstr Qty.
DFD405101	Stick-E Lathing Washer 1"	100	1000
DFD405100	Lathing Washer (No Stick-E)	100	1000
DFD405716	Stick-E Insulation Washer 1-7/16"	100	1000
DFD405901	Stick-E Denz Glass Washer 1-1/4"	250	1000
DFD405338	Stick-E BX Clip 3/8"	100	1000
DFD405412	Stick-E Conduit Clamp 1/2"	50	200
DFD405434	Stick-E Conduit Clamp 3/4"	50	200
DFD405410	Stick-E Conduit Clamp 1"	50	100
DFD405312R	Stick-E Mini Conduit Clip 1/2"	100	1000
DFD405334R	Stick-E Mini Conduit Clip 3/4"	100	1000
DFD405310R	Stick-E Mini Conduit Clip 1"	100	1000
DFD405902	Stick-E Cable Tie Donut 1-1/4"	100	1000
DFD405550	Stick-E Right Angle Clip 90°	100	1000
DFD405530	Stick-E Angle Clip 60°	100	1000
DFD405214	Stick-E Rod Hanger 1/4"-20	100	1000
DFD405238	Stick-E Rod Hanger 3/8"-16	100	1000
DFD405215	Stick-E Post Nut Rod Hanger 1/4"-20	100	1000
DFD405239	Stick-E Post Nut Rod Hanger 3/8"-16	100	1000
DFD405112	Stick-E Strap Mtl Washer 1/2"	100	1000
DFD405300	Stick-E Rebar/Dowel Basket Clip	100	1000
DFD405610	Stick-E Square Washer 1"	100	1000
DFD405102	Stick-E SS Sealing Washer 3/4"	100	1000



Angle clips are 3/4-inch wide and 2mm thick with a 5/16-inch wire hole.  
Rebar/dowel basket clips are sized to accept #3 rebar and 3/8-inch dowels.

**GAS FASTENING**

**TRAK-IT® C5**  
Gas-Free Fastening System

**NOTES**

A large grid area for taking notes, consisting of many small squares. The grid is approximately 30 columns wide and 40 rows high, providing a structured space for writing or drawing.



**DEWALT**

Maximum Power

**DEWALT**

DEWALT

# DEWALT®

ENGINEERED BY Powers™

DEWALT Engineered By Powers  
701 E. Joppa Rd.  
Towson, MD 21286  
Phone: (800) 524-3244  
Fax: (877) 871-1965  
[www.DEWALT.com](http://www.DEWALT.com)

Stanley Black & Decker Canada Corporation  
6275 Millcreek Drive  
Mississauga, Ontario L5N 7K6  
Phone: (800) 567-7188  
Fax: (800) 265-9680

Cat. No. DWDIRFASMAN  
©2019 Stanley Black & Decker

©2019 DEWALT. The following are examples of trademarks for one or more DEWALT power tools and accessories: The yellow and black color scheme; the "D"-shaped air intake grill; the array of pyramids on the handgrip; the kit box configuration; and the array of lozenge-shaped humps on the surface of the tool.