

ICC-ES Evaluation Report

ESR-2966

Reissued December 2024

This report also contains:



- [City of LA Supplement](#)

Subject to renewal December 2025

- [FL Supplement w/ HVHZ](#)

ICC-ES Evaluation Reports are not to be construed as representing aesthetics or any other attributes not specifically addressed, nor are they to be construed as an endorsement of the subject of the report or a recommendation for its use. There is no warranty by ICC Evaluation Service, LLC, express or implied, as to any finding or other matter in this report, or as to any product covered by the report.

Copyright © 2024 ICC Evaluation Service, LLC. All rights reserved.

<p>DIVISION: 04 00 00 — MASONRY.</p> <p>Section: 04 05 19.16 — Masonry Anchors</p>	<p>REPORT HOLDER: DEWALT</p>  <p>ADDITIONAL LISTEE: THE HILLMAN GROUP</p>	<p>EVALUATION SUBJECT: POWER-STUD®+ SD1 EXPANSION ANCHORS IN MASONRY (DEWALT)</p>	
--	--	--	---

1.0 EVALUATION SCOPE

Compliance with the following codes:

- 2024, 2021, 2018, 2015, and 2012 [International Building Code® \(IBC\)](#)
- 2024, 2021, 2018, 2015, and 2012 [International Residential Code® \(IRC\)](#)

Main references of this report are for the 2024 IBC and IRC. See [Table 4](#) and [Table 5](#) for applicable sections of the code for previous IBC and IRC editions.

Property evaluated:

- Structural

2.0 USES

The Power-Stud+ SD1 expansion anchors are used for anchoring building components and structural connections in predrilled holes to grout-filled uncracked concrete masonry units, to resist static, wind and seismic tension and shear loads. The anchors are alternatives to the cast-in-place anchors described in Section 8.1.4 of TMS 402, as applicable, as referenced in Section 2107.1 of the IBC. The anchors may also be used where an engineered design is submitted in accordance with Section R301.1.3 of the IRC.

3.0 DESCRIPTION

3.1 Power-Stud+ SD1:

Power-Stud+ SD1 anchors are torque-controlled, mechanical expansion anchors comprised of an anchor body, expansion wedge (clip), washer and hex nut. Product names for the report holder and for the additional listees are presented in the following table.

COMPANY NAME	PRODUCT NAME
DEWALT	Power-Stud+ SD1
The Hillman Group	Hillman Power-Stud+ SD1
	Power Pro SD1 Wedge Anchor

Available diameters recognized for use in masonry are $\frac{3}{8}$ inch, $\frac{1}{2}$ inch, and $\frac{5}{8}$ inch (9.5 mm, 12.7 mm and 15.9 mm). The anchor body and expansion clip are manufactured from medium carbon steel complying with requirements set forth in the approved quality documentation and have minimum 0.0002-inch-thick (5 µm) zinc

plating in accordance with ASTM B633, SC1, Type III. The washers comply with ASTM F844. The hex nuts comply with ASTM A563, Grade A. The Power-Stud+ SD1 expansion anchor is illustrated in [Figure 2](#).

The anchor body is comprised of a high-strength threaded rod at one end and a tapered mandrel at the other end. The tapered mandrel is enclosed by a three-section expansion clip that freely moves around the mandrel. The expansion clip movement is restrained by the mandrel taper and by a collar. The anchors are installed in a predrilled hole with a hammer. When torque is applied to the nut of the installed anchor on the threaded end of the anchor body, the mandrel at the other end of the anchor is drawn into the expansion clip, forcing it outward into the sides of the predrilled hole in the base material.

3.2 Grout-filled Concrete Masonry:

The compressive strength of masonry, f_m , at 28 days must be a minimum of 1,500 psi (10.3 MPa). Grout-filled masonry must be constructed from the following materials:

3.2.1 Concrete Masonry Units: Grout-filled concrete masonry walls must be constructed from minimum Grade N, Type II, lightweight, medium-weight or normal-weight concrete masonry units (CMUs) conforming to ASTM C90 (IBC). The minimum allowable nominal size of the CMU must be 6 inches wide by 8 inches high by 16 inches long (i.e. 6x8x16).

3.2.2 Grout: The masonry units must be fully grouted with grout complying with Section 2103.3 of the IBC, or Section R606.2.12 of the IRC, as applicable, and having a minimum compressive strength as indicated in these code sections at 28 days.

3.2.3 Mortar: Mortar must be Type N, S or M, prepared in accordance with Section 2103.2.1 of the IBC; or Section R606.2.8 of the IRC, as applicable.

4.0 DESIGN AND INSTALLATION

4.1 Allowable Stress Design (ASD):

The allowable load values for anchors described in this report are based on allowable stress design under the IBC. Allowable tension and shear loads for installation in uncracked grout-filled concrete masonry are noted in [Table 3](#).

Allowable loads are given in [Table 3](#) for anchors installed into grouted masonry wall faces at a critical spacing distance, s_{cr} , between anchors of 16 times the anchor diameter. The spacing distance between two anchors may be reduced to a minimum spacing distance, s_{min} , of 8 times the anchor diameter provided the allowable tension loads are multiplied by a reduction factor of 0.80 and allowable shear loads are multiplied by a reduction factor of 0.90. Linear interpolation for calculation of allowable loads may be used for intermediate anchor spacing distances.

The allowable loads for anchors installed in grout-filled concrete masonry subjected to combined tension and shear forces must be determined by the following equation:

$$\left(\frac{P_s}{P_t}\right)^{\frac{5}{3}} + \left(\frac{V_s}{V_t}\right)^{\frac{5}{3}} \leq 1 \quad (\text{Eq-1})$$

where:

P_s = Applied service tension load.

P_t = Allowable service tension load.

V_s = Applied service shear load.

V_t = Allowable service shear load.

4.2 Installation:

The Power-Stud+ SD1 expansion anchors must be installed in accordance with the manufacturer's published installation instructions and this report. Anchor locations must comply with this report and the plans and specifications approved by the code official. Installation parameters are provided in [Table 1](#) and [Figure 3](#). Anchors must be installed in holes drilled into the concrete using carbide-tipped masonry drill bits complying with ANSI B212.15-1994. The nominal drill bit diameter must be equal to that of the anchor. The dust and debris must be removed from the predrilled hole using a hand pump, compressed air or vacuum to remove loose particles left from drilling. The anchor must be hammered into the predrilled hole until the proper nominal embedment depth is achieved. The nut must be tightened against the washer until the torque values specified in [Table 1](#) are achieved.

4.3 Special Inspection:

Special inspection under the IBC and IRC must be provided in accordance with Sections 1704 and 1705 of the IBC. The special inspector must make periodic inspections during anchor installation to verify anchor type, anchor dimensions, drill bit size, masonry type, masonry thickness, mortar type, anchor location, anchor embedment and adherence to the manufacturer's printed installation instructions.

5.0 CONDITIONS OF USE

The Power-Stud+ SD1 expansion anchors described in this report comply with, or are suitable alternatives to what is specified in, those codes listed in Section 1.0 of this report, subject to the following conditions:

- 5.1 The anchors must be installed in accordance with the manufacturer's published installation instructions and this report. In case of conflict, this report governs.
- 5.2 Anchor sizes, dimensions, and minimum embedment depths are as set forth in this report.
- 5.3 Prior to installation, calculations and details demonstrating compliance with this report must be submitted to the code official. The calculations and details must be prepared by a registered design professional where required by the statutes of the jurisdiction in which the project is to be constructed.
- 5.4 Design of anchors installed in grout-filled uncracked concrete masonry to resist static, wind and seismic load applications must be in accordance with Section 4.1 of this report.
- 5.5 The grout and mortar shall have attained its minimum design strength prior to the installation of the anchors.
- 5.6 When using the basic load combinations in accordance with IBC Section 1605.1, allowable loads are not permitted to be increased for wind or earthquake loading. When using the alternative basic load combinations for the IBC, the allowable loads or load combinations may not be adjusted.
- 5.7 Since an ICC-ES acceptance criteria for evaluating data to determine the performance of expansion anchors subjected to fatigue and shock loading is unavailable at this time, the use of these anchors under these conditions is beyond the scope of this report.
- 5.8 Where not otherwise prohibited by the code, anchors are permitted for installation in fire-resistance-rated construction provided at least one of the following conditions is fulfilled:
- 5.9 Anchors are used to resist wind or seismic forces only.
- 5.10 Anchors that support fire-resistance-rated construction or gravity load-bearing structural elements are within a fire-resistance-rated envelope or a fire-resistance-rated membrane; are protected by approved fire-resistance-rated materials; or have been evaluated for resistance to fire exposure in accordance with recognized standards.
- 5.11 Anchors are used to support nonstructural elements.
- 5.12 Since an ICC-ES acceptance criteria for evaluating data to determine the performance of expansion anchors in cracked masonry is unavailable at this time, the use of anchors must be limited to installation in uncracked grout-filled concrete masonry. Cracking occurs when $f_t > f_r$ due to service loads or deformations.
- 5.13 Use of carbon steel anchors is limited to dry, interior locations.
- 5.14 Special inspection must be provided in accordance with Section 4.3 of this report, where applicable.
- 5.15 Anchors are manufactured under an approved quality control program with inspections by ICC-ES.

6.0 EVIDENCE SUBMITTED

Data in accordance with the [ICC-ES Acceptance Criteria for Expansion Anchors in Masonry Elements \(AC01\)](#), dated March 2018 (editorially revised November 2024), for use in grout-filled uncracked concrete masonry; including optional seismic tests in tension and shear.

7.0 IDENTIFICATION

- 7.1 The ICC-ES mark of conformity, electronic labeling, or the evaluation report number (ICC-ES ESR-2966) along with the name, registered trademark, or registered logo of the report holder and/or listee must be included in the product label.
- 7.2 In addition, the Power-Stud+ SD1 expansion anchors are identified by dimensional characteristics and packaging. A length letter code, visible after installation, is stamped on each anchor on the exposed

















threaded stud end along with the number “1”. [Table 2](#) summarizes the length code identification system. A plus sign (+) is also marked with the number “1” on all anchors recognized in this report. Packages are identified with the product name, type and size and the company name as set forth in Section 3.1 of this report.

7.3 The report holder’s contact information is the following:

DEWALT
701 EAST JOPPA ROAD
TOWSON, MARYLAND 21286
(800) 524-3244
www.DEWALT.com
anchors@DEWALT.com

7.4 The Additional Listees’ contact information is the following:

THE HILLMAN GROUP
1280 KEMPER MEADOW DRIVE
CINCINNATI, OHIO 45240

DeWALT Dust Removal Drilling System with HEPA Dust Extractor Options		
Tool	Accessories and Shrouds	Dust Extractor
SDS-Max Drills		
 Cordless  Corded	 SDS-Max Hollow Drill Bits	 Dust Extractor
	 SDS-Max Drill Bits With Shroud	
SDS-Plus Drills		
 Cordless  Corded	 SDS-Plus Drill Bits	 Cordless On-board Dust Extractor
	 SDS-Plus Stop Drill Bits	
	 SDS-Plus Hollow Drill Bits	 Dust Extractor
	 SDS-Plus Drill Bits With Telescope  SDS-Plus Drill Bits With Suction Tube	
 SDS-Plus Drill Bits With Shroud  SDS-Plus Stop Drill Bits With Shroud		

The DEWALT drilling systems shown above collect and remove dust with a HEPA dust extractor during the hole drilling operation in dry base materials using hammer-drills. See manufacturer’s printed installation instructions.

FIGURE A—EXAMPLES OF DEWALT DUST REMOVAL DRILLING SYSTEMS WITH HEPA DUST EXTRACTORS FOR ILLUSTRATION

TABLE 1—POWER-STUD+ SD1 ANCHOR INSTALLATION SPECIFICATIONS IN GROUT-FILLED CONCRETE MASONRY

Anchor Property / Setting Information	Notation	Units	Nominal Anchor Diameter		
			3/8 inch	1/2 inch	5/8 inch
Anchor diameter	d_a	in. (mm)	0.375 (9.5)	0.500 (12.7)	0.625 (15.9)
Minimum diameter of hole clearance in fixture	d_h	in. (mm)	7/16 (11.1)	9/16 (14.3)	11/16 (17.5)
Nominal drill bit diameter (ANSI)	d_{bit}	in.	3/8	1/2	5/8
Installation torque	T_{inst}	ft.-lbf. (N-m)	20 (27)	40 (54)	50 (68)
Torque wrench/socket size	-	in.	9/16	3/4	15/16
Nut height	-	ln.	21/64	7/16	35/64

For SI: 1 inch = 25.4 mm, 1 ft-lbf = 1.356 N-m.

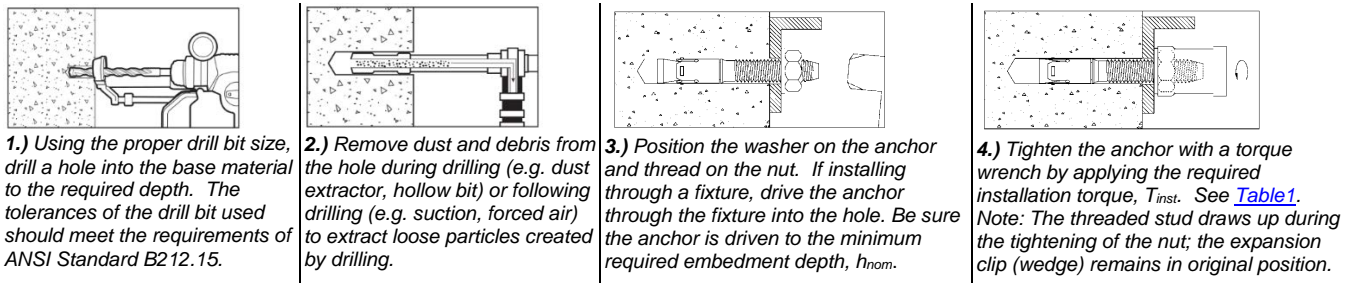

FIGURE 1—POWER-STUD+ SD1 INSTALLATION INSTRUCTIONS

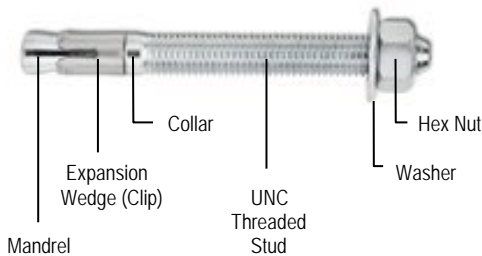

FIGURE 2—POWER-STUD+ SD1 ANCHOR ASSEMBLY

TABLE 2—POWER-STUD+ SD1 ANCHOR LENGTH CODE IDENTIFICATION SYSTEM

Length ID marking on threaded stud head		A	B	C	D	E	F	G	H	I
Overall anchor length, (inches)	From	1 1/2	2	2 1/2	3	3 1/2	4	4 1/2	5	5 1/2
	Up to but not including	2	2 1/2	3	3 1/2	4	4 1/2	5	5 1/2	6
Length ID marking on threaded stud head (cont.)		J	K	L	M	N	O	P	Q	R
Overall anchor length, (inches)	From	6	6 1/2	7	7 1/2	8	8 1/2	9	9 1/2	10
	Up to but not including	6 1/2	7	7 1/2	8	8 1/2	9	9 1/2	10	11

TABLE 3—ALLOWABLE TENSION AND SHEAR LOAD CAPACITIES FOR POWER-STUD+ SD1 EXPANSION ANCHORS INSTALLED IN GROUT-FILLED CONCRETE MASONRY^{1,2,3,6}

ANCHOR INSTALLED INTO GROUTED MASONRY WALL FACES ⁴						
ANCHOR DIAMETER d_a (inch)	MIN. EMBED. h_{nom} (inches)	MIN. EDGE DISTANCE (inches)	MIN. END DIST. (inches)	TENSION LOAD (pounds)	SHEAR LOAD (pounds)	
				IBC / IRC	Direction of Loading	IBC / IRC
3/8	2 ³ / ₈	4	4	445	Any	595
1/2	2 ¹ / ₂	4	4	530	Any	560
		4	12	530	∥ to Edge	805
		12	4		∥ to End	
5/8	3 ³ / ₈	4	4	705	Any	685
		4	12	705	∥ to Edge	1,065
		12	4		∥ to End	
ANCHOR INSTALLED INTO TOPS OF GROUTED MASONRY WALLS ⁵						
ANCHOR DIAMETER d_a (inch)	MIN. EMBED. h_{nom} (inches)	MIN. EDGE DISTANCE (inches)	MIN. END DIST. (inches)	TENSION LOAD (pounds)	SHEAR LOAD (pounds)	
				IBC / IRC	Direction of Loading	IBC / IRC
3/8	2 ³ / ₈	1 ³ / ₄	12	295	⊥ to Edge	230
					∥ to Edge	485
1/2	2 ¹ / ₂	2 ¹ / ₄	12	445	Any	230
	5	2 ¹ / ₄	12	685	⊥ to Edge	280
5/8	3 ³ / ₈	2 ¹ / ₄	12	765	∥ to Edge	565
					Any	230
					⊥ to Edge	340
	6 ¹ / ₄	2 ¹ / ₄	12	765	∥ to Edge	705

For SI: 1 inch = 25.4 mm, 1 psi = 6.89 kPa, 1 lbf = 4.45 N.

¹Tabulated load values are for anchors installed in minimum 6-inch-wide (152 mm) grout-filled concrete masonry units described in Section 3.2 of this report. If the specified compressive strength of the masonry, f'_m , is minimum 2,000 psi (13.8 MPa) the tabulated values may be increased by 20 percent. See Figure 3 for permitted anchor locations.

²The embedment depth, h_{nom} , is measured from the outside surface of the concrete masonry unit to the embedded end of the anchor prior to tightening.

³When using the basic load combinations in accordance with IBC Section 1605.1, allowable loads are not permitted to be increased for wind or earthquake loading. When using the alternative basic load combinations for the IBC, the allowable loads or load combinations may not be adjusted.

⁴The tabulated values are applicable for anchors installed into grouted masonry wall faces at a critical spacing distance, s_{cr} , between anchors of 16 times the anchor diameter. The spacing distance between two anchors may be reduced to a minimum distance, s_{min} , of 8 times the anchor diameter but provided the allowable tension loads are multiplied by a reduction factor of 0.80 and allowable shear loads are multiplied by a reduction factor of 0.90. Linear interpolation for calculation of allowable loads may be used for intermediate anchor spacing distances.

⁵Anchor installations into tops of grouted masonry walls are limited to one per masonry cell.

⁶Anchors may be installed in the grouted cells and in cell webs and bed joints not closer than 1³/₈ inches from head joints. The minimum edge and end distances must also be maintained.

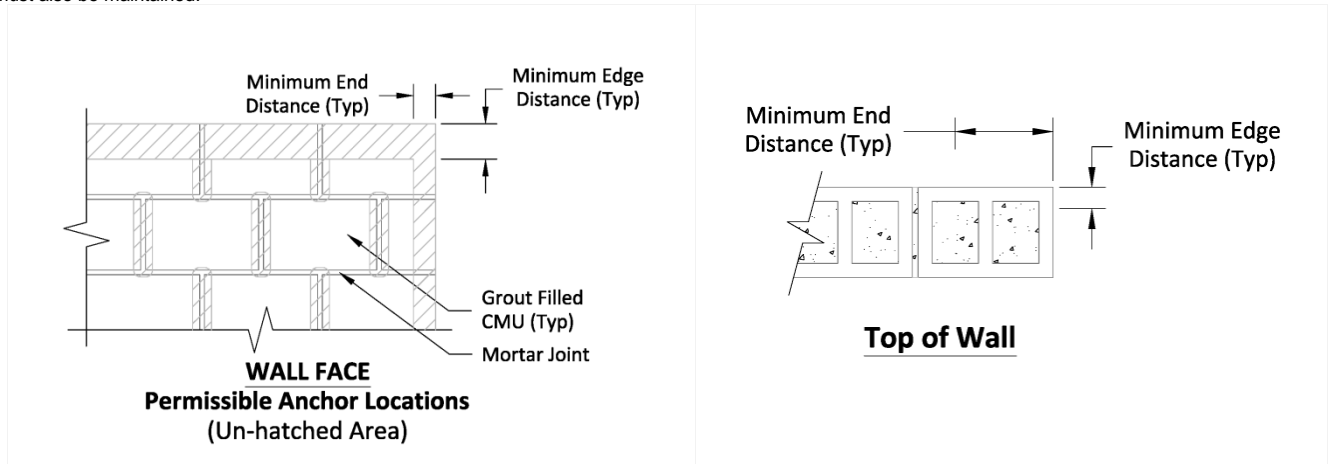

FIGURE 3—POWER-STUD+ SD1 EXPANSION ANCHORS INSTALLED INTO GROUT-FILLED CONCRETE MASONRY

TABLE 4— APPLICABLE SECTIONS OF THE IBC CODE UNDER EACH EDITION OF THE IBC AND IRC

IBC				
2024 IBC	2021 IBC	2018 IBC	2015 IBC	2012 IBC
Section 1605.1		Section 1605.3.1		
Section 1704				
Section 1705				
Chapter 21				
Section 2103.2.1				
Section 2103.3				
Section 2107.1				
IRC				
2024 IRC	2021 IRC	2018 IRC	2015 IRC	2012 IRC
Section R301.1.3				
Section R606.2.8			Section R606.2.7	Section R607.1
Section R606.2.12			Section R606.2.11	Section R609.1.1

TABLE 5— APPLICABLE SECTIONS OF TMS 402 UNDER EACH EDITION OF THE IBC

2024 IBC	2021 IBC	2018 IBC	2015 IBC	2012 IBC
TMS 402-22	TMS 402-16		TMS 402-13	TMS-402-11
Section 8.1.4	Section 8.1.3		Section 2.1.4	

DIVISION: 04 00 00—MASONRY
Section: 04 05 19.16—Masonry Anchors

REPORT HOLDER:

DEWALT

EVALUATION SUBJECT:

POWER-STUD®+ SD1 EXPANSION ANCHORS IN MASONRY (DEWALT)

1.0 REPORT PURPOSE AND SCOPE

Purpose:

The purpose of this evaluation report supplement is to indicate that the Power-Stud+ SD1 Expansion Anchors in fully grouted concrete masonry, described in ICC-ES evaluation report [ESR-2966](#), have also been evaluated for compliance with the codes noted below as adopted by the Los Angeles Department of Building and Safety (LADBS).

Applicable code editions:

- 2023 *City of Los Angeles Building Code* ([LABC](#))
- 2023 *City of Los Angeles Residential Code* ([LARC](#))

2.0 CONCLUSIONS

The Power-Stud+ SD1 Expansion Anchors in fully grouted concrete masonry, described in Sections 2.0 through 7.0 of the evaluation report [ESR-2966](#), comply with the LABC Chapter 21, and the LARC, and are subject to the conditions of use described in this supplement.

3.0 CONDITIONS OF USE

The Power-Stud+ SD1 Expansion Anchors described in this evaluation report supplement must comply with all of the following conditions:

- All applicable sections in the evaluation report [ESR-2966](#).
- The design, installation, conditions of use and identification of the anchors are in accordance with the 2021 *International Building Code*® (IBC) provisions noted in the evaluation report [ESR-2966](#).
- The design, installation and inspection are in accordance with additional requirements of LABC Chapters 16 and 17, and the City of Los Angeles Information Bulletin P/BC 2023-092, as applicable.
- Under the LARC, an engineered design in accordance with LARC Section R301.1.3 must be submitted.
- The allowable design values listed in the evaluation report and tables are for the connection of the anchors to fully grouted masonry. The connection between the anchors and the connected members shall be checked for capacity (which may govern).
- For use in wall anchorage assemblies to flexible diaphragm applications, anchors shall be designed per the requirements of City of Los Angeles Information Bulletin P/BC 2023-071.

This supplement expires concurrently with the evaluation report, reissued December 2024.

DIVISION: 04 00 00—MASONRY
Section: 04 05 19.16—Masonry Anchors

REPORT HOLDER:

DEWALT

EVALUATION SUBJECT:**POWER-STUD®+ SD1 EXPANSION ANCHORS IN MASONRY (DEWALT)****1.0 REPORT PURPOSE AND SCOPE****Purpose:**

The purpose of this evaluation report supplement is to indicate that the Power-Stud+ SD1 Expansion Anchors in Masonry described in ICC-ES evaluation report ESR-2966, have also been evaluated for compliance with the codes noted below.

Applicable code editions:

- 2023 Florida Building Code—Building
- 2023 Florida Building Code—Residential

2.0 CONCLUSIONS

The Power-Stud+ SD1 Expansion Anchors in Masonry described in Sections 2.0 through 7.0 of the evaluation report ESR-2966, comply with the *Florida Building Code—Building* and the *Florida Building Code—Residential*. The design requirements must be determined in accordance with the *Florida Building Code—Building* or the *Florida Building Code—Residential*, as applicable. The installation requirements noted in ICC-ES evaluation report ESR-2966 for the 2021 *International Building Code*® meet the requirements of the *Florida Building Code—Building* and the *Florida Building Code—Residential*, as applicable.

Use of the Power-Stud+ SD1 Expansion Anchors in Masonry has also been found to be in compliance with the High-Velocity Hurricane Zone Provisions of the *Florida Building Code—Building* and the *Florida Building Code—Residential*, with the following additional conditions:

- a) Design and installation must meet the requirements of Section 2122.7 of the *Florida Building Code—Building*.
- b) For anchorage to wood members, the connection subject to uplift must be designed for no less than 700 pounds (3114 N).

For products falling under Florida Rule 61G20-3, verification that the report holder's quality assurance program is audited by a quality-assurance entity approved by the Florida Building Commission for the type of inspections being conducted is the responsibility of an approved validation entity (or the code official, when the report holder does not possess an approval by the Commission).

This supplement expires concurrently with the evaluation report, reissued December 2024.