

# ICC-ES Evaluation Report

**ESR-4042**

Reissued July 2024

Revised October 2024

Subject to renewal July 2025



This report also contains:

- [FL Supplement w/HVHZ](#)

- [City of LA Supplement](#)

ICC-ES Evaluation Reports are not to be construed as representing aesthetics or any other attributes not specifically addressed, nor are they to be construed as an endorsement of the subject of the report or a recommendation for its use. There is no warranty by ICC Evaluation Service, LLC, express or implied, as to any finding or other matter in this report, or as to any product covered by the report.

Copyright © 2024 ICC Evaluation Service, LLC. All rights reserved.

<p><b>DIVISION: 04 00 00— MASONRY</b></p> <p><b>Section: 04 05 19.16— Masonry Anchors</b></p>	<p><b>REPORT HOLDER: DEWALT</b></p>  <p><b>ADDITIONAL LISTEE: THE HILLMAN GROUP</b></p>	<p><b>EVALUATION SUBJECT: SCREW-BOLT+™ ANCHORS IN MASONRY (DEWALT)</b></p>	
---	--	--	---

## 1.0 EVALUATION SCOPE

Compliance with the following codes:

- 2024, 2021, 2018, 2015 and 2012 [International Building Code® \(IBC\)](#)
- 2024, 2021, 2018, 2015 and 2012 [International Residential Code® \(IRC\)](#)

Main references of this report are for the 2024 IBC and IRC. See Table 4 and Table 5 for applicable sections of the code for previous IBC and IRC editions.

Property evaluated:

Structural

## 2.0 USES

The Screw-Bolt+ anchors described in Section 3.1 of this report are used to anchor building components to fully grouted concrete masonry walls to resist static, wind and earthquake tension and shear loads, as noted in Section 4.0 of this report.

The anchors are alternatives to Section 8.1.4 of TMS 402 as referenced in Section 2107.1 of the IBC. The anchor system may also be used where an engineered design is submitted in accordance with Section R301.1.3 of the IRC.

## 3.0 DESCRIPTION

### 3.1 Screw-Bolt+ Anchors:

Screw-Bolt+ anchors are comprised of an anchor body with hex washer head or flat head (countersunk) style in various lengths. Available diameters are 1/4-inch, 3/8-inch, 1/2-inch, 5/8-inch and 3/4-inch (6.4 mm, 9.5 mm, 12.7 mm, 15.9 mm and 19.1 mm). The anchor body and hex washer head or flat head are manufactured from low-carbon steel which is case hardened and have minimum 0.0002-inch (5 μm) zinc plating in accordance with ASTM B633 or minimum 0.0021-inch (53 μm) mechanically galvanized zinc plating in accordance with ASTM B695, Class 55. The Screw-Bolt+ anchor is illustrated in [Table A](#). Product names for the report holder and for the additional listees are presented in the following table.

COMPANY NAME	PRODUCT NAME
DEWALT	Screw-Bolt+
The Hillman Group	Hillman Screw-Bolt+
	Power Pro Screw-Bolt+

The hex head of the anchor is formed with an integral washer and serrations on the underside. The anchor body is formed with dual lead threads and a chamfered tip. The screw anchors are installed in a predrilled hole with a powered impact wrench or torque wrench. The threads on the anchor tap into the sides of the predrilled hole and interlock with the base material during installation.

### 3.2 Grout-filled Concrete Masonry (Fully Grouted):

The compressive strength of masonry,  $f'_m$ , at 28 days must be a minimum of 1,500 psi (10.3 MPa). Fully grouted masonry walls must comply with Chapter 21 of the IBC and must be constructed from the following materials:

**3.2.1 Concrete Masonry Units (CMUs):** Concrete masonry walls must be constructed from minimum Grade N, light-, medium-, or normal weight closed end, concrete masonry units (CMUs) conforming to ASTM C90. The nominal CMU size is 8 inches wide by 8 inches high by 16 inches long.

**3.2.2 Grout (for Grout-filled Concrete Masonry):** Grout-filled concrete masonry units must be fully grouted with grout complying with Section 2103.3 of the IBC or Section R606.2.12 of the IRC. Alternatively, the grout must have a minimum compressive strength, when tested in accordance with ASTM C1019, equal to its specified strength, but not less than 2,000 psi (13.8 MPa).

**3.2.3 Mortar:** Mortar must be Types M, S or N prepared in accordance with Section 2103.2.1 of the IBC, or Section R606.2.8 of the IRC.

## 4.0 DESIGN AND INSTALLATION

### 4.1 Allowable Stress Design:

**4.1.1 Design of Anchors Installed in Fully Grouted CMU Masonry:** The design load values for anchors described in this report are based on allowable stress design (ASD), as an alternative to Section 8.1.4 of TMS 402 as referenced in Section 2107.1 of the IBC. For use under the IRC, an engineered design in accordance with R301.1.3 must be submitted to the code official. Allowable tension and shear loads for installation in grout-filled masonry walls are noted in [Tables 1](#) through [3](#) of this report.

Allowable stress design tension and shear load values given in [Tables 2](#) and [3](#) in grout-filled concrete masonry may be used to resist long-term loads, such as gravity loads, and short-term loads, such as wind and seismic.

The allowable loads for anchors installed in fully grout-filled concrete masonry or hollow masonry subjected to combined tension and shear forces must be determined by the following equation:

$$\left(\frac{P_s}{P_t}\right)^n + \left(\frac{V_s}{V_t}\right)^n \leq 1$$

where:

$P_s$  = Applied service tension load (lbf or kN).

$P_t$  = Allowable service tension load (lbf or kN).

$V_s$  = Applied service shear load (lbf or kN).

$V_t$  = Allowable service shear load (lbf or kN).

$n$  =  $5/3$  for the  $1/2$ -inch,  $5/8$ -inch and  $3/4$ -inch (9.5 mm, 12.7 mm, 15.9 mm and 19.1 mm) anchors installed in the face of grout-filled concrete masonry.

$n$  = 1 for the  $1/4$ -inch and  $3/8$ -inch (6.4 mm and 9.5 mm) anchors installed in the face of grout-filled concrete masonry and all anchor diameters installed in the top of grout-filled concrete masonry.

**4.1.2 Requirements for Minimum Spacing and Minimum Edge:** Critical and minimum spacing and edge distance values, with appropriate reduction values, where applicable, are given in [Tables 2](#) and [3](#) for fully grouted concrete masonry. Linear interpolation may be used to determine the allowable load reduction factor for intermediate anchor spacing and edge distances.

### 4.2 Installation:

Anchors must be installed in accordance with this report and the manufacturer's printed installation instructions (MPII) represented in [Figure 1](#). The anchors must not be installed until the base material has reached its minimum designated compressive strength. The drill bit size, hole diameter, embedment depth, spacing, edge distance and base material must comply with the requirements of this report. Installation procedures and locations must be in accordance with [Tables 1](#), [2](#) and [3](#) as well as [Figures A](#), [1](#), [2](#), [3](#) and [4](#) of this report, as applicable.

### 4.3 Special Inspection:

Anchor must be installed with special inspections in accordance with IBC Section 1704 and 1705, and are also applicable for installations under the IRC.

For screw anchors installed with special inspection, the following items, as applicable, must be inspected: anchor type, anchor dimensions, masonry type, masonry dimensions and compressive strength, drill bit size, anchor spacing, edge distances, embedment, and adherence to the manufacturer's printed installation instructions (MPII).

## 5.0 CONDITIONS OF USE:

The Screw-Bolt+™ anchors described in this report are suitable alternatives to what is specified in, those codes listed in Section 1.0 of this report, subject to the following conditions:

**5.1** The anchors must be identified and installed in accordance with this report and the MPII. In the event of a conflict between the instructions in this report and the manufacturer's instructions, this report must govern.

- 5.2 Anchor sizes, dimensions, and minimum embedment depths are as set forth in this report.
- 5.3 Anchors resisting static and wind tension and shear loads in concrete masonry must be designed in accordance with Section 4.1 of this report.
- 5.4 For installations in grouted concrete masonry, anchors are recognized to dead, live, seismic and wind tension and shear load applications. When using the basic load combinations in accordance with IBC Section 1605.1, allowable loads are not permitted to be increased for wind or seismic loading. The allowable loads or load combinations for these anchors must not be adjusted.
- 5.5 Anchors must be installed in holes predrilled in substrates described in this report, using carbide-tipped drill bits complying with ANSI B212.15-1994.
- 5.6 The grout and mortar shall have attained its minimum design strength prior to installation of the anchors.
- 5.7 Prior to installation, calculations demonstrating that the applied loads are less than the allowable loads described in this report must be submitted to the code official for approval. The calculations must be prepared by a registered design professional where required by the statutes of the jurisdiction in which the project is being constructed.
- 5.8 Since an ICC-ES acceptance criteria for evaluating data to determine the performance of screw anchors subjected to fatigue and shock loading is unavailable at this time, the use of these anchors under these conditions is beyond the scope of this report.
- 5.9 Where not otherwise prohibited by the code, anchors are permitted for installation in fire-resistance-rated construction provided at least one of the following conditions is fulfilled:
  - Anchors are used to resist wind or seismic forces only.
  - Anchors that support fire-resistance-rated construction or gravity load-bearing structural elements are within a fire-resistance-rated envelope or a fire-resistance-rated membrane, are protected by approved fire-resistance-rated materials, or have been evaluated for resistance to fire exposure in accordance with recognized standards.
  - Anchors are used to support nonstructural elements.
- 5.10 Since evaluation of the performance of anchors in cracked masonry is beyond the scope of this criteria, the use of anchors is limited to installation in uncracked masonry. Cracking occurs when  $f_t > f_r$  due to service loads or deformations.
- 5.11 Use of carbon steel anchors with zinc plating in accordance with ASTM B633 as described in Section 3.1 of this report is limited to dry interior locations.
- 5.12 Steel anchoring elements in contact with preservative-treated wood or fire-retardant-treated wood must be zinc coated in accordance with ASTM B695, Class 55 (mechanically galvanized zinc plating).
- 5.13 Use of carbon steel anchors with mechanically galvanized zinc plating in accordance with ASTM B695, Class 55 as described in Section 3.1 is permitted for exterior exposure or damp environments.
- 5.14 Special inspection, when required, must be provided in accordance with Section 4.3 of this report.
- 5.15 The Screw-Bolt+ anchors are manufactured under a quality-control program with inspections by ICC-ES.

## 6.0 EVIDENCE SUBMITTED

- 6.1 Data in accordance with the [ICC-ES Acceptance Criteria for Pre-drilled Fasteners \(Screw Anchors\) in Masonry \(AC106\)](#), dated March 2018 (editorially revised September 2024), including tests for seismic qualification, edge distance and spacing, and installations for the top of fully-grouted CMU wall construction.
- 6.2 Quality-control documentation.

## 7.0 IDENTIFICATION

- 7.1 The ICC-ES mark of conformity, electronic labeling, or the evaluation report number (ICC-ES ESR-4042) along with the name, registered trademark, or registered logo of the report holder and/or listee must be included in the product label.
- 7.2 In addition, the Screw-Bolt+ anchors are identified in the field by dimensional characteristics and packaging. A diameter and length marking is stamped on the head of each Screw-Bolt+ anchor; these are visible after installation for verification. Packages are identified with the company name as set forth in Section 3.1 of this report; anchor name; part number; type; and anchor size and length.
- 7.3 The report holder's contact information is the following:

**DEWALT**  
**701 EAST JOPPA ROAD**  
**TOWSON, MARYLAND 21286**  
**(800) 524-3244**  
[www.DEWALT.com](http://www.DEWALT.com)  
[anchors@DEWALT.com](mailto:anchors@DEWALT.com)

- 7.4 The Additional Listee's contact information is the following:

**THE HILLMAN GROUP**  
**1280 KEMPER MEADOW DRIVE**  
**CINCINNATI, OHIO 45240**  
[info@hillmangroup.com](mailto:info@hillmangroup.com)

TABLE A—DESIGN TABLE INDEX AND ANCHOR ILLUSTRATION<sup>1</sup>

Adhesive	Base Material	Anchor Sizes (inch)	Allowable Load Data	Screw-Bolt+ Illustration Hex Head and Flat Head Versions
Screw-Bolt+	Grout-filled Concrete Masonry	1/4, 3/8, 1/2, 5/8, 3/4	Table 1 (wall faces and openings)	
		1/2, 5/8, 3/4	Table 2 (top of wall)	

<sup>1</sup>Design must be in accordance with Section 4.1 of this report and applicable allowable load data for the given conditions, as applicable.

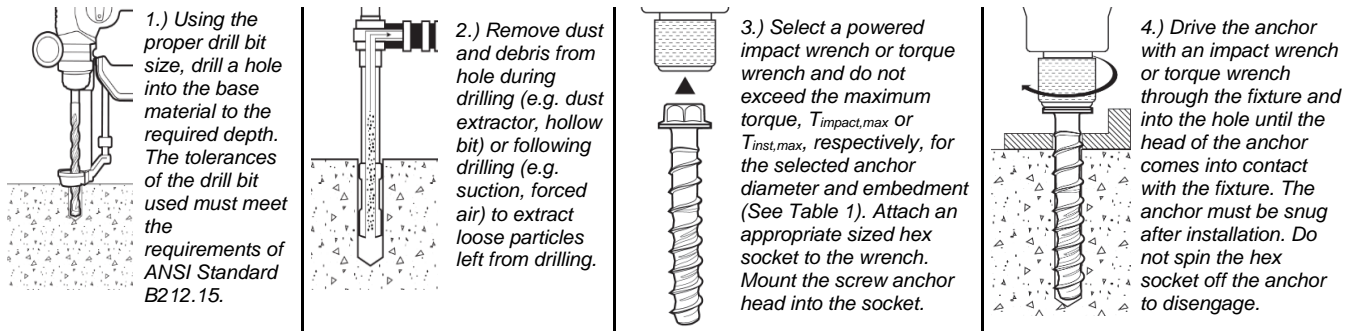

FIGURE 1—SCREW-BOLT+ INSTALLATION INSTRUCTIONS, MPII (Hex Head Version Illustrated, Flat Head Version Not Shown)

TABLE 1—SCREW-BOLT+ ANCHOR INSTALLATION AND SUPPLEMENTAL INFORMATION

Anchor Property / Setting Information		Notation	Units	Nominal Anchor Size (inch)									
				1/4		3/8		1/2		5/8		3/4	
Head style	-	-	-	Hex Head or Flat Head		Hex Head or Flat Head		Hex Head or Flat Head		Hex Head		Hex Head	
Nominal anchor diameter	$d_a$	in.		0.250		0.375		0.500		0.625		0.750	
Minimum diameter of fixture hole clearance <sup>8</sup>	$d_h$	in.		1 <sup>1</sup> / <sub>32</sub>		1/2		5/8		3/4		7/8	
Nominal carbide drill bit diameter (ANSI)	$d_{bit}$	in.		1/4		3/8		1/2		5/8		3/4	
Minimum nominal embedment depth <sup>1</sup>	$h_{nom}$	in.		1 <sup>5</sup> / <sub>8</sub>	2 <sup>1</sup> / <sub>2</sub>	2	3 <sup>1</sup> / <sub>4</sub>	2 <sup>1</sup> / <sub>2</sub>	4 <sup>1</sup> / <sub>4</sub>	3 <sup>1</sup> / <sub>4</sub>	5	4	6 <sup>1</sup> / <sub>4</sub>
Minimum hole depth	$h_o$	in.		2	2 <sup>7</sup> / <sub>8</sub>	2 <sup>3</sup> / <sub>8</sub>	3 <sup>5</sup> / <sub>8</sub>	2 <sup>7</sup> / <sub>8</sub>	4 <sup>5</sup> / <sub>8</sub>	3 <sup>5</sup> / <sub>8</sub>	5 <sup>3</sup> / <sub>8</sub>	4 <sup>3</sup> / <sub>8</sub>	6 <sup>5</sup> / <sub>8</sub>
Critical edge distance <sup>2</sup>	$c_{cr}$	in.	See Table 2 for anchors installed in wall faces <sup>7</sup>										
Minimum edge distance <sup>3</sup>	$c_{min}$	in.	See Table 3 for anchors installed in the top of grout-filled concrete masonry										
Critical spacing distance <sup>2</sup>	$s_{cr}$	in.	See Table 2 for anchors installed in wall faces <sup>7</sup>										
Minimum spacing distance <sup>3</sup>	$s_{min}$	in.	See Table 3 for anchors installed in the top of grout-filled concrete masonry										
Minimum nominal anchor length <sup>4,9</sup>	$l_{anch}$	in.		1 <sup>3</sup> / <sub>4</sub>	2 <sup>5</sup> / <sub>8</sub>	2 <sup>1</sup> / <sub>2</sub>	4	3	5	4	6	5	8
Maximum impact wrench power (torque rating) <sup>5</sup>	$T_{impact,max}$	ft.-lb.		150		300		300		300		300	
Max. manual installation torque <sup>6</sup>	$T_{inst,max}$	ft.-lb.		18	25	25	40	45	60	60	70		
Hex Head	Wrench socket size	-	in.	7/16		9/16		3/4		15/16		1 <sup>1</sup> / <sub>8</sub>	
	Max. head height	-	in.	2 <sup>1</sup> / <sub>64</sub>		3/8		3 <sup>1</sup> / <sub>64</sub>		3 <sup>7</sup> / <sub>64</sub>		4 <sup>3</sup> / <sub>64</sub>	
	Max. washer dia.	-	in.	3 <sup>7</sup> / <sub>64</sub>		3/4		1 <sup>1</sup> / <sub>16</sub>		1 <sup>1</sup> / <sub>8</sub>		1 <sup>13</sup> / <sub>32</sub>	
Flat Head	Driver size	-	In.	T-30		T-50		T-55		-		-	
	Max head diameter	-	in.	1 <sup>7</sup> / <sub>32</sub>		5 <sup>7</sup> / <sub>64</sub>		1		-		-	
	Countersunk angle	-	In.	82		82		82		-		-	
Effective tensile stress area (screw anchor body)	$A_{se}$	in. <sup>2</sup>		0.045		0.094		0.176		0.274		0.399	
Minimum specified ultimate strength	$f_{uta}$	psi		100,000		105,000		115,000		95,000		95,000	
Minimum specified yield strength	$f_{ya}$	psi		80,000		84,000		92,000		76,000		76,000	

For SI: 1 inch = 25.4 mm, 1 ft-lb = 1.356 N-m, 1 psi = 0.0069 N/mm<sup>2</sup> (MPa).

<sup>1</sup>The embedment depth,  $h_{nom}$ , is measured from the outside surface of the concrete member to the embedded end of the anchor.

<sup>2</sup>Critical spacing and edge distances are the anchor distances for which no reduction in load capacity is required.

<sup>3</sup>Minimum spacing and edge distances are the smallest anchor distances allowed for installation.

<sup>4</sup>The listed minimum anchor length is based on the anchor sizes commercially available at the time of publication compared with the requirements to achieve the minimum nominal embedment depth, including consideration of a fixture attachment. The minimum nominal length for hex head anchors is measured from under the head to the tip of the anchor, the minimum nominal length for flat head anchors is measured from the top of the head to the tip of the anchor.

<sup>5</sup>Due to the variability in measurement procedures, the published torque of an impact tool may not correlate with the listed maximum impact wrench power. Over-torquing post-installed anchors can damage the anchor and/or reduce its holding capacity.

<sup>6</sup>Maximum manual installation torque is provided for installations using a calibrated torque wrench.

<sup>7</sup>Installations in wall faces are applicable for screw anchors in the ends of grout-filled concrete masonry units where minimum edge and end distances are maintained.

<sup>8</sup>The minimum diameter of fixture hole clearance is for the body of the anchor to pass through structural steel members; clearance holes may be up to 1/8-inch less than tabulated values (same as nominal drill bit diameter) provided the screw anchors are installed through light gauge cold-formed steel members or wood members.

<sup>9</sup>Hex head anchors with the following minimum anchor lengths are also suitable for use with cold-formed steel members provided the nominal thickness of the fixture attachment does not exceed 20 gauge (0.036-inch base metal thickness):

For 1/2-inch-diameter anchors with 2<sup>1</sup>/<sub>2</sub>-inch nominal embedment, 2<sup>1</sup>/<sub>2</sub>-inch long anchors.

For 5/8-inch-diameter anchors with 5-inch nominal embedment, 5-inch long anchors.

For 3/4-inch-diameter anchors with 4-inch nominal embedment, 4-inch long anchors.

TABLE 2—ALLOWABLE SCREW-BOLT+ TENSION AND SHEAR LOAD CAPACITIES INSTALLED INTO GROUT-FILLED CONCRETE MASONRY UNITS<sup>1,2,3,4,5,6,7,8,9</sup>

TENSION LOAD								
Anchor Diameter, <i>d</i> (inches)	Minimum Embedment, <i>h<sub>nom</sub></i> (inches)	Allowable Load at <i>c<sub>cr</sub></i> and <i>s<sub>cr</sub></i> (pounds)	Spacing Distance, <i>s</i>			Edge or End Distance, <i>c<sub>2</sub></i> or <i>c<sub>1</sub></i> (see <a href="#">Figure 2</a> )		
			Critical Distance, <i>s<sub>cr</sub></i> (inches)	Minimum Distance, <i>s<sub>min</sub></i> (inches)	Allowable Load Factor at <i>s<sub>min</sub></i>	Critical Distance, <i>c<sub>cr</sub></i> (inches)	Minimum Distance, <i>c<sub>min</sub></i> (inches)	Allowable Load Factor at <i>c<sub>min</sub></i>
1/4	1 <sup>5</sup> / <sub>8</sub>	315	4	2	1.0 (no reduction)	3 <sup>3</sup> / <sub>4</sub>	1 <sup>1</sup> / <sub>4</sub>	0.60
	2 <sup>1</sup> / <sub>2</sub>	605						
3/8	2	450	6	3	1.0 (no reduction)	6	1 <sup>1</sup> / <sub>2</sub>	0.70
	3 <sup>1</sup> / <sub>4</sub>	1,085						
1/2	2 <sup>1</sup> / <sub>2</sub>	610	8	4	1.0 (no reduction)	8	2 <sup>5</sup> / <sub>8</sub>	0.75
	4 <sup>1</sup> / <sub>4</sub>	1,190						
5/8	3 <sup>1</sup> / <sub>4</sub>	880	10	4	1.0 (no reduction)	10	3 <sup>3</sup> / <sub>8</sub>	0.90
	5	1,270						
3/4	4	1,150	12	4	1.0 (no reduction)	12	4	1.0 (no reduction)
	6 <sup>1</sup> / <sub>4</sub>	1,355						

SHEAR LOAD										
Anchor Diameter, <i>d</i> (inches)	Minimum Embedment, <i>h<sub>nom</sub></i> (inches)	Allowable Load at <i>c<sub>cr</sub></i> and <i>s<sub>cr</sub></i> , Direction 1 & 2 (pounds) <sup>10</sup>	Allowable Load at <i>c<sub>cr</sub></i> and <i>s<sub>cr</sub></i> , Direction 3 & 4 (pounds) <sup>10</sup>	Spacing Distance, <i>s</i>			Edge or End Distance, <i>c<sub>2</sub></i> or <i>c<sub>1</sub></i> (see <a href="#">Figure 2</a> )			
				Critical Distance, <i>s<sub>cr</sub></i> (inches)	Minimum Distance, <i>s<sub>min</sub></i> (inches)	Allowable Load Factor at <i>s<sub>min</sub></i>	Critical Distance, <i>c<sub>cr</sub></i> (inches)	Minimum Distance, <i>c<sub>min</sub></i> (inches)	Allowable Load Factor at <i>c<sub>min</sub></i>	
									Load Perpendicular to Edge or End (Direction 1 & 2)	Load Parallel to Edge or End (Direction 3 & 4)
1/4	1 <sup>5</sup> / <sub>8</sub>	400	400	4	2	1.0 (no reduction)	3 <sup>3</sup> / <sub>4</sub>	1 <sup>1</sup> / <sub>4</sub>	0.35	1.0 (no reduction)
	2 <sup>1</sup> / <sub>2</sub>	505	505							
3/8	2	815	815	6	3	1.0 (no reduction)	6	1 <sup>1</sup> / <sub>2</sub>	0.27	1.0 (no reduction)
	3 <sup>1</sup> / <sub>4</sub>	935	935							
1/2	2 <sup>1</sup> / <sub>2</sub>	1,380	1,380	8	4	1.0 (no reduction)	8	2 <sup>5</sup> / <sub>8</sub>	0.20	1.0 (no reduction)
	4 <sup>1</sup> / <sub>4</sub>	2,180	2,180							
5/8	3 <sup>1</sup> / <sub>4</sub>	2,090	2,225	10	4	1.0 (no reduction)	10	3 <sup>3</sup> / <sub>8</sub>	0.23	1.0 (no reduction)
	5	2,640	2,640							
3/4	4	2,800	3,330	12	4	1.0 (no reduction)	12	4	0.25	1.0 (no reduction)
	6 <sup>1</sup> / <sub>4</sub>	3,100	3,685							

For SI: 1 inch = 25.4 mm; 1 lbs = 0.0044 kN, 1 psi = 0.006894 MPa.

<sup>1</sup>All values are for anchors installed in fully grouted concrete masonry wall construction with materials in compliance with Section 3.2 of this report. Concrete masonry units must be light-, medium-, or normal-weight conforming to ASTM C90. Allowable loads are based on a safety factor of 5.0.

<sup>2</sup>Anchors are recognized to dead, live, seismic and wind tension and shear load applications. See Sections 4.1 and 5.4 of this report for design with load combinations. For combined loading, see Section 4.1 of this report.

<sup>3</sup>Anchors may be installed in any location in the face of the masonry wall (cell, web, bed joint) except within 1<sup>1</sup>/<sub>4</sub> inch from the of the vertical mortar joint (head joint), center-to-center, provided the minimum edge and end distances are maintained.

<sup>4</sup>A maximum of two anchors may be installed in a single masonry cell in accordance with the spacing and edge or end distance requirements. Embedment is measured from the outside surface of the concrete masonry unit to the embedded end of the anchor. See [Figure 2](#) of this report.

<sup>5</sup>The critical spacing distance, *s<sub>cr</sub>*, is the anchor spacing where full load values in the table may be used. The minimum spacing distance, *s<sub>min</sub>*, is the minimum anchor spacing for which values are available and installation is permitted. Spacing distance is measured from the centerline to centerline between two anchors.

<sup>6</sup>The critical edge or end distance, *c<sub>cr</sub>*, is the distance where full load values in the table may be used. The minimum edge or end distance, *c<sub>min</sub>*, is the minimum distance for which values are available and installation is permitted. Edge or end distance is measured from anchor centerline to the closest unrestrained edge.

<sup>7</sup>The tabulated values are applicable for anchors installed into the ends of grout-filled concrete masonry units (e.g. wall opening) where minimum edge distances are maintained.

<sup>8</sup>Load values for anchors installed less than *s<sub>cr</sub>* and *c<sub>cr</sub>* must be multiplied by the appropriate load reduction factor based on actual spacing (*s*) or edge distance (*c*). Load factors are multiplicative; both spacing and edge reduction factors must be considered.

<sup>9</sup>Linear interpolation of load values between minimum spacing (*s<sub>min</sub>*) and critical spacing (*s<sub>cr</sub>*) and between minimum edge or end distance (*c<sub>min</sub>*) and critical edge or end distance (*c<sub>cr</sub>*) is permitted.

<sup>10</sup>See [Figure 3](#) for illustration of shear load directions.

**TABLE 3—ALLOWABLE SCREW-BOLT+ TENSION AND SHEAR LOADS FOR THREADED RODS INSTALLED INTO THE TOPS OF GROUT-FILLED CONCRETE MASONRY UNITS<sup>1,2,3,4,5,6,7,8,9,10</sup>**

Anchor Diameter <i>d</i> (inches)	Minimum Embedment <i>h<sub>nom</sub></i> (inches)	Minimum Spacing Distance (inches)	Minimum Edge Distance, (inches)	Minimum End Distance, (inches)	Tension Load (pounds)	Shear Load (pounds)	
						Load Perpendicular to Edge of Masonry Wall (   to end)	Load Parallel to Edge of Masonry Wall (⊥ to end)
1/2	4 1/4	8 (see Note 5 for reduced minimum spacing distances)	3 3/4	8	1,210	255	580
			1 3/4		810		
5/8	5	10	1 3/4	10	900	260	950
3/4	6 1/4	12	1 3/4	12	1,215	260	990

For SI: 1 inch = 25.4 mm; 1 lbs = 0.0044 kN, 1 psi = 0.006894 MPa.

- <sup>1</sup> All values are for anchors installed in fully grouted concrete masonry wall construction with materials in compliance with Section 3.2 of this report. Concrete masonry units must be light-, medium, or normal-weight conforming to ASTM C90. Allowable loads are based on a safety factor of 5.0.
- <sup>2</sup> Anchors are recognized to dead, live, seismic and wind tension and shear load applications. See Sections 4.1 and 5.4 of this report for design with load combinations. For combined loading, see Section 4.1 of this report.
- <sup>3</sup> Anchors may be installed in any location in the top of the masonry wall except within 1 1/4 inch from the mortar joint (head joint), provided the minimum edge and end distances are maintained.
- <sup>4</sup> A maximum of two anchors may be installed in a single masonry cell in accordance with the spacing and edge or end distance requirements. Embedment is measured from the outside surface of the concrete masonry unit to the embedded end of the anchor. See Figure 4 of this report.
- <sup>5</sup> Minimum spacing distance for 1/2-inch-diameter anchors shall be 8 inches and may be reduced to 2 inches provided the allowable load reduction factor of 0.40 is applied. Linear interpolation may be used to determine the reduction factor for intermediate anchor spacing distances between 8 inches and 2 inches.
- <sup>6</sup> Spacing distance is measured from the centerline to centerline between two anchors.
- <sup>7</sup> Linear interpolation may be used to for 1/2-inch-diameter anchors to determine allowable loads for edge distances between 3 3/4 inches and 1 3/4 inches.
- <sup>8</sup> The edge and end distance is measured from the anchor centerline to the closest unrestrained edge and end of the CMU block, respectively. See Figure 4 of this report for an illustration of the top of grouted masonry walls.
- <sup>9</sup> Spacing distance is measured from the centerline to centerline between two anchors.
- <sup>10</sup> Allowable shear loads parallel and perpendicular to the edge of a masonry wall may be applied in or out of plane, respectively. See Figure 4.

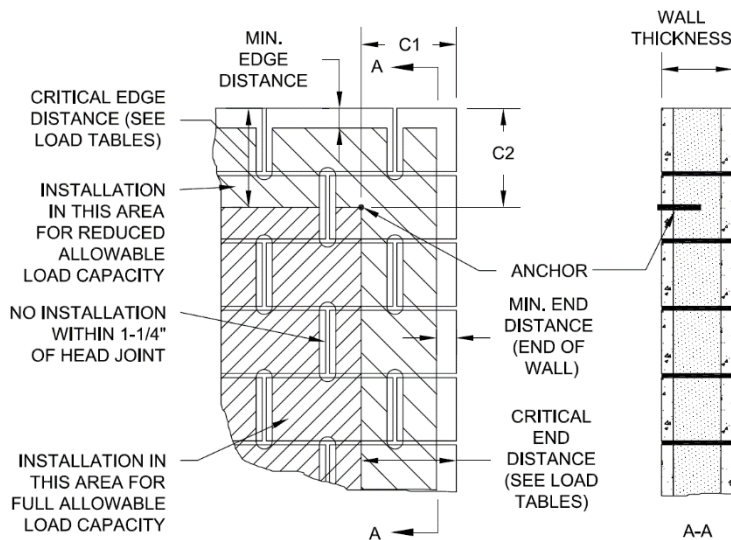

**FIGURE 2—ILLUSTRATION OF SCREW-BOLT+ ANCHORS INSTALLED INTO GROUTED CONCRETE MASONRY WALL**

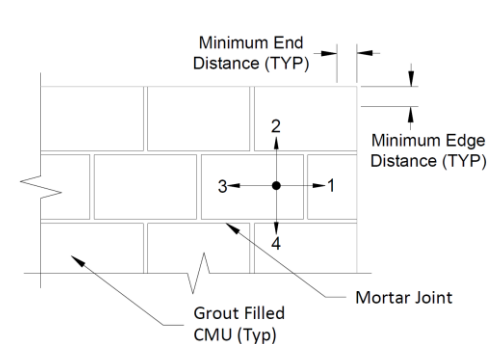

**FIGURE 3—DIRECTION OF SHEAR LOADING IN RELATION TO EDGE AND END OF MASONRY WALL**

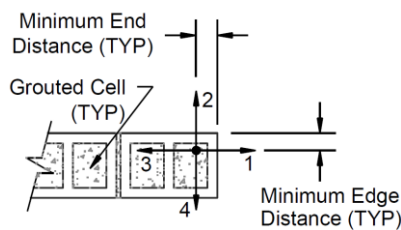

- (1) Shear load parallel to Edge and perpendicular to End
- (2) Shear load parallel to End and perpendicular to Edge
- (3) Shear load parallel to Edge and perpendicular away from End
- (4) Shear load parallel to End and perpendicular to opposite Edge

**FIGURE 4—SCREW-BOLT+ ANCHORS INSTALLED INTO THE TOP OF GROUTED CONCRETE MASONRY WALL**

TABLE 4— APPLICABLE SECTIONS OF THE IBC CODE UNDER EACH EDITION OF THE IBC AND IRC

IBC				
2024 IBC	2021 IBC	2018 IBC	2015 IBC	2012 IBC
Section 1605.1		Section 1605.3.1		
Section 1704				
Section 1705				
Section 2103.2.1			Section 2103.9	
Section 2103.3			Section 2103.13	
Section 2107.1				
IRC				
2024 IRC	2021 IRC	2018 IRC	2015 IRC	2012 IRC
Section R301.1.3				
Section R606.2.8			Section 606.2.7	Section R607.1
Section R606.2.12			Section 606.2.11	Section R609.1.1

TABLE 5— APPLICABLE SECTIONS OF TMS 402 UNDER EACH EDITION OF THE IBC

IBC				
2024 IBC	2021 IBC	2018 IBC	2015 IBC	2012 IBC
TMS 402-22	TMS 402-16		TMS 402-13	TMS 402-11
Section 8.1.4	Section 8.1.3			Section 2.1.4



The DEWALT drilling systems shown collect and remove dust with a HEPA dust extractor during the hole drilling operation in dry base materials using hammer-drill (see step 1 of the manufacturer’s printed installation instructions).

FIGURE A—EXAMPLES OF DEWALT DUST REMOVAL DRILLING SYSTEMS WITH HEPA DUST EXTRACTORS FOR ILLUSTRATION

**DIVISION: 04 00 00—MASONRY**  
**Section: 04 05 19.16—Masonry Anchors**

**REPORT HOLDER:**

DEWALT

**EVALUATION SUBJECT:**

SCREW-BOLT+™ ANCHORS IN MASONRY (DEWALT)

**1.0 REPORT PURPOSE AND SCOPE****Purpose:**

The purpose of this evaluation report supplement is to indicate that Screw-Bolt+ Anchors in Masonry, described in ICC-ES evaluation report [ESR-4042](#), have also been evaluated for compliance with the codes noted below as adopted by Los Angeles Department of Building and Safety (LADBS).

**Applicable code editions:**

- 2023 *City of Los Angeles Building Code* ([LABC](#))
- 2023 *City of Los Angeles Residential Code* ([LARC](#))

**2.0 CONCLUSIONS**

The Screw-Bolt+ Anchors in Masonry, described in Sections 2.0 through 7.0 of the evaluation report [ESR-4042](#), comply with LABC Chapter 21, and LARC, and are subjected to the conditions of use described in this supplement.

**3.0 CONDITIONS OF USE**

The Screw-Bolt+ Anchors in Masonry described in this evaluation report supplement must comply with all of the following conditions:

- All applicable sections in the evaluation report [ESR-4042](#).
- The design, installation, conditions of use and labeling of the anchors are in accordance with the 2021 *International Building Code*® (IBC) provisions noted in the evaluation report [ESR-4042](#).
- The design, installation and inspection are in accordance with additional requirements of LABC Chapters 16 and 17, as applicable.
- Under the LARC, an engineered design in accordance with LARC Section R301.1.3 must be submitted.
- The allowable design values listed in the evaluation report and tables are for the connection of the anchors to masonry substrate. The connection between the anchors and the connected members shall be checked for capacity (which may govern).
- For use in wall anchorage assemblies to flexible diaphragm applications, anchors shall be designed per the requirements of City of Los Angeles Information Bulletin P/BC 2023-071.

This supplement expires concurrently with the evaluation report, reissued July 2024 and revised October 2024.



**DIVISION: 04 00 00—MASONRY**  
**Section: 04 05 19.16—Masonry Anchors**

**REPORT HOLDER:****DEWALT****EVALUATION SUBJECT:****SCREW-BOLT+™ ANCHORS IN MASONRY (DEWALT)****1.0 REPORT PURPOSE AND SCOPE****Purpose:**

The purpose of this evaluation report supplement is to indicate that the Screw-Bolt+ Anchors in Masonry, described in ICC-ES evaluation report ESR-4042, has also been evaluated for compliance with the codes noted below.

**Applicable code editions:**

- 2023 Florida Building Code—Building
- 2023 Florida Building Code—Residential

**2.0 CONCLUSIONS**

The Screw-Bolt+ Anchors in Masonry, described in Sections 2.0 through 7.0 of the evaluation report ESR-4042, comply with the *Florida Building Code—Building* and the *Florida Building Code—Residential*. The design requirements must be determined in accordance with the *Florida Building Code—Building* or the *Florida Building Code—Residential*, as applicable. The installation requirements noted in the ICC-ES evaluation report ESR-4042 for the 2021 *International Building Code*® meet the requirements of the *Florida Building Code—Building* or the *Florida Building Code—Residential*, as applicable.

Use of Screw-Bolt+ Anchors in Masonry has also been found to be in compliance with the High-velocity Hurricane Zone provisions of the *Florida Building Code—Building* and the *Florida Building Code—Residential*, with the following conditions:

- a) Design and installation must meet the requirements of Section 2122.7 of the *Florida Building Code—Building*.
- b) For anchorage to wood members, the connection subject to uplift, must be designed for no less than 700 pounds (3114N).

For products falling under Florida Rule 61G20-3, verification that the report holder's quality assurance program is audited by a quality assurance entity approved by the Florida Building Commission for the type of inspections being conducted is the responsibility of an approved validation entity (or the code official, when the report holder does not possess an approval by the Commission).

This supplement expires concurrently with the evaluation report, reissued July 2024 and revised October 2024.