



RubberGard™ EPDM Roof Systems Tested Assembly Guide

March 2023

NOTE: The contents of this guide are considered accurate at the time of posting. All information contained within should be validated for accuracy as it relates to specific project conditions or requirements. Specific codes, uplifts or other factors may result in changes to the information contained within this document. Validate all specific conditions with a Holcim Regional Technical Coordinator prior to its use.

Table of Contents

Underwriters Laboratories (UL)	6
General	6
Maintenance and Repair Systems	6
General Notations	7
UL Certifications (TFGU.R9516)	7
Elevate TPO – General Components	9
RubberGard EPDM - Ballasted	10
Elevate EPDM – Ballasted – Class A.....	10
Elevate EcoWhite EPDM – Ballasted – Class A	11
RubberGard EPDM – Adhered Membrane	11
RubberGard EPDM LS-FR – Adhered Membrane – Class A	12
RubberGard EPDM LS-FR – Adhered Membrane – Class B	13
RubberGard EPDM LS-FR – Adhered Membrane – Class C	14
RubberGard Platinum EPDM – Adhered Membrane – Class A	14
RubberGard Platinum EPDM – Adhered Membrane – Class B	15
Fire Retardant RubberGard EPDM – Adhered Membrane – Class A.....	15
Fire Retardant RubberGard EPDM – Adhered Membrane – Class B.....	16
RubberGard MAX, MAX PT and/or MAX FR – Adhered Membrane – Class A	17
RubberGard MAX, MAX PT and/or MAX FR – Adhered Membrane – Class B	20
RubberGard EPDM SA – Self Adhered Membrane – Class A	20
RubberGard EPDM SA – Self Adhered Membrane – Class B	21
RubberGard EcoWhite EPDM – Adhered Membrane – Class A.....	21
RubberGard EcoWhite EPDM – Adhered Membrane – Class B	22
RubberGard EPDM – Adhered Membrane	22
RubberGard LS-FR EPDM – Attached Membrane – Class A	22
RubberGard LS-FR EPDM – Attached Membrane – Class B	23
RubberGard Platinum EPDM – Attached Membrane – Class A	23
RubberGard MAX, MAX PT and/or MAX FR EPDM – Attached Membrane – Class A	24
RubberGard MAX, MAX PT and/or MAX FR EPDM – Attached Membrane – Class B	26
Fire Retardant RubberGard EPDM – Attached Membrane – Class A.....	27
RubberGard MAX EPDM – Maintenance and Repair Systems - Attached Membrane – Class A	27
EPDM – Maintenance and Repair Systems - Attached Membrane – Class A	28
UL Internal Fire Ratings	28

Factory Mutual General Information	30
Ground Roughness Definitions	30
Ballasted Systems	31
Large Wall Opening Enhancement	31
Factory Mutual (FM) Hail Ratings	32
FM Hail Ratings	32
FM – Very Severe Hail	33
Factory Mutual (FM) – Roof Zone Definition	33
Factory Mutual (FM) – Prescriptive Enhancement Options – Perimeter and Corner	35
Mechanically Securement of Insulation Enhancement	35
Adhesive Securement of Insulation Enhancement	35
Mechanically Attached Membrane Securement Enhancement	36
InvisiWeld Securement Enhancement	36
Base Sheet Attachment Over FM Approved Deck Types	36
Mechanically Attached Membrane – Preliminary Insulation Securement	37
ASCE 7 – Basic Wind Speeds for Risk/Occupancy Category	37
ASCE - American Society of Civil Engineers - Roof Zones – ASCE 7-10 (IBC 2015/2012)	37
ASCE 7-10 Perimeter and Corner Definition - Examples	38
ASCE 7-16 (IBC 2018)	38
ASCE 7-16 Perimeter and Corner Definition – Examples	39
FM Approvals RoofNav Assemblies – Adhered Membrane	41
RubberGard EPDM LS-FR (Adhered) – Steel Deck – ISO (CF) – Gypsum Cover Board (Attached)	41
RubberGard EPDM (Adhered) – Jet Bond Adhesive – Steel Deck – ISO (Attached)	47
RubberGard EPDM (Adhered) – Jet Bond Adhesive – Steel Deck – ISO (Attached) – ISO (Adhered)	50
RubberGard EPDM (Adhered) – Steel Deck – ISO (CF) – ISOGARD HD (Attached)	52
RubberGard EPDM (Adhered) – Steel Deck – ISO (Attached) – ISOGARD HD/HD Comp. (Adhered)	53
EPDM (Adhered) – Steel Deck – ISO (Attached) – ISO (Adhered) – ISOGARD HD/HD Comp. (Adhered)	56
EPDM (Adhered) – Steel Deck – ISO (Attached) – Gypsum Cover Board (Adhered)	57
EPDM (Adhered) – Steel Deck – ISO (Attached) – ISO (Adhered) – Gypsum Cover Board (Adhered)	58
EPDM LS-FR (Adhered) – Concrete Deck – Vapor Barrier – ISO (Adhered)	59
Re-Roof – EPDM LS-FR (Adhered) – Gypsum Deck – ISO/Cover Board (Adhered)	61
EPDM MAX/MAX FR (Adhered) – Concrete Deck – V-Force – ISO/Cover Board (Adhered)	62
Re-Roof - EPDM MAX/MAX FR (Adhered) – Gypsum Deck – ISO/Cover Board (Adhered)	64
EPDM Platinum (Adhered) – Concrete Deck – V-Force – ISO (Adhered)	65

Re-Roof – EPDM Platinum (Adhered) – Gypsum Deck – ISO/Cover Board (Adhered)	67
EcoWhite EPDM (Adhered) – Concrete Deck – V-Force – ISO/Cover Board (Adhered)	68
Re-Cover – EcoWhite EPDM (Adhered) – Treated Wood Deck – ISO/Cover Board (Attached)	69
Re-Roof – EcoWhite EPDM (Adhered) – Gypsum Deck – ISO/Cover Board (Adhered)	69
EcoWhite EPDM (Adhered) – Concrete Deck – ISO/Cover Board (Attached).....	70
EPDM LS-FR/SA (Adhered) – Steel Deck – ISO/Cover Board (Attached).....	70
RubberGard EPDM SA (Adhered) – Concrete Deck – ISO/Cover Board (Adhered)	73
RubberGard EPDM SA (Adhered) – Concrete Deck – ISO (Attached) – ISO/Cover Board (Adhered)	77
RubberGard EPDM SA (Adhered) – Steel Deck – Thermal Barrier (Attached) – ISO/Cover Board (Adhered)	78
RubberGard EPDM SA (Adhered) – Steel Deck – ISO (Attached) – ISO (Adhered).....	82
RubberGard EPDM SA (Adhered) – Steel Deck – ISO (Attached) – ISO/Cover Board (Adhered)	84
RubberGard EPDM SA (Adhered) – Steel Deck – ISO/Cover Board (Attached)	88
RubberGard EPDM SA (Adhered) – Steel Deck – ISO/Cover Board (Attached)	88
Re-Roof – EPDM LS-FR (Adhered) – Steel Deck – ISO/Cover Board (Attached).....	90
EPDM MAX/MAX FR (Adhered) – Steel Deck – ISO/Cover Board (Attached).....	90
Re-Roof – EPDM MAX/MAX FR (Adhered) – Steel Deck – ISO/Cover Board (Attached)	94
Re-Cover – EPDM MAX/MAX FR (Adhered) – Steel Deck – ISO/Cover Board (Attached)	94
EPDM MAX/MAX FR (Adhered) – Concrete Deck – ISO (Attached) – ISO/Cover Board (Adhered)	95
EPDM Platinum (Adhered) – Steel Deck – ISO/Cover Board (Attached)	96
Re-Roof – EPDM Platinum (Adhered) – Steel Deck – ISO/Cover Board (Attached)	98
EPDM Platinum (Adhered) – Concrete Deck – ISO/Cover Board (Attached)	99
EcoWhite EPDM (Adhered) – Steel Deck – ISO/Cover Board (Attached).....	99
EcoWhite EPDM (Adhered) – Steel Deck – ISO (Attached) – Cover Board (Adhered)	101
EcoWhite EPDM (Adhered) – Steel Deck – ISO (Attached) – ISO (Adhered) – Cover Board (Adhered)	102
Re-Cover – EPDM (Adhered) – Treated Wood Deck – ISO (Attached).....	103
FM Approvals RoofNav Assemblies – Attached Membrane	103
EPDM LS-FR (Attached) – Steel Deck – ISO/Cover Board (Attached)	103
EPDM LS-FR (QuickSeam R.M.A) – Steel Deck – ISO/Cover Board (Attached).....	103
EPDM MAX (Attached) – Steel Deck – ISO/Cover Board (Attached).....	104
EPDM MAX FR (Attached) – Steel Deck – ISO/Cover Board (Attached).....	106
EPDM MAX (QuickSeam R.M.A.) – Steel Deck – ISO/Cover Board (Attached).....	108
EPDM MAX FR (QuickSeam R.M.A.) – Steel Deck – ISO/Cover Board (Attached).....	109
Platinum EPDM (Attached) – Steel Deck – ISO/Cover Board (Attached)	111
Metal Building Re-Cover (Insulated) – EPDM MAX (RMA/Batten Attached) – ISO/Cover Board (Attached)	113

Metal Building Re-Cover (Un-Insulated) – EPDM MAX (RMA/Batten Attached) – ISO/Cover Board (Attached).....	114
Metal Building Re-Cover (Un-Insulated) – EPDM MAX (RMA/Plate and Fastener Attached) – ISO/Cover Board (Attached).....	115
Metal Building Re-Cover (Un-Insulated) – EPDM MAX (Batten and Fastener Attached) – ISO/Cover Board (Attached)	115
Metal Building Re-Cover (Un-Insulated) – EPDM MAX (Plate and Fastener Attached) – ISO/Cover Board (Attached)	116
Factory Mutual Ballast Guidelines	116
Stone Ballast	116

Underwriters Laboratories (UL)

General

All regional building codes and most local building code officials require that roofing systems meet minimum performance requirements when exposed to external fire sources. The accepted method for measuring external fire resistance is ASTM E-108. This test standard, and closely related standards such as Underwriters Laboratories UL-790 and Uniform Building Code 15-2, is used to determine the ability of a roof system to hinder the horizontal spread or vertical penetration of an external fire source. In accordance with these standards, all classified roof covering assemblies fall into one of the three following categories.

The class of roof covering required by each regional building code depends upon many factors, including the use and location of the building and the type of construction. The local building authority should always be consulted as to what the roofing assembly classification will need to be for each roofing project.

It should be noted that these classifications apply to roofing assemblies, and NOT the roofing membrane. A roofing membrane that is classified as part of a Class A assembly when installed over a particular insulation may not qualify as part of a Class A assembly with another insulation.

The “UL Item Number” in the following listings has been added as a service to those who have the UL Building Materials Directory. It identifies the UL listing from which our Code Approval Guide listing derives.

Exterior Fire Ratings:

1. **CLASS A:** Includes roof coverings which are effective against severe fire exposures
2. **CLASS B:** Includes roof coverings which are effective against moderate fire exposures
3. **CLASS C:** Includes roof coverings which are effective against light fire exposures

Deck Classifications:

1. **Noncombustible Roof Decks (NC):** Steel, Concrete, Poured Gypsum – require testing for horizontal spread of flame.
2. **Combustible Roof Decks (C):** Wood, Plywood, Tectum – require testing for both horizontal spread and vertical penetration of flame.

The following information has been referenced from the UL Online Certification Directory document: TGFU.GuidelInfo

- Certified gypsum wallboard, any thickness, may be included in any roofing system without adversely affecting the certification. Insulation may be attached to the deck with fasteners, hot mopping asphalt or certified adhesive.
- Certified insulated systems may be installed over existing certified insulated systems when:
 - The new system is certified for use with the existing roof insulation type (glass fiber, perlite, wood fiber, foamed plastic, etc.)
 - The total thickness of insulation in both systems does not exceed the maximum specified for the new system being applied.

Maintenance and Repair Systems

These roofing systems are composed of various types of roofing applications which are specifically limited for installation (recover) over existing roofing systems as specified. These systems may not meet certification requirements without being used over existing systems. Recovering may also be accomplished with certified new construction roofing systems where compatibility has been determined by test, by empirical data or by known performance properties of similar materials to the test methods. The following guidelines are provided to assist Authorities Having Jurisdiction in determining the suitability of a new construction roofing system as a recover system.

Noncombustible Deck Construction:

1. Insulated roof systems may be utilized over any type of existing roof system and maintain its new construction rating when the roof deck is noncombustible.
2. Insulated multiple-layered hot mopped, cold application or modified bitumen membrane new construction systems with a base ply of Type G1 or Type G2 may be used over any existing roof system and maintain its new

construction rating when the roof deck is noncombustible. The insulation may be omitted from the re-cover system.

- Uninsulated multiple-layered hot mopped, cold application or modified bitumen membrane new construction systems with a base ply of Type G1 or Type G2 may be used over any existing uninsulated roof system and maintain its new construction rating when the roof deck is noncombustible.

Combustible Deck Construction:

- Insulated roof systems certified for use over combustible deck can be used over any type of existing roof system and maintain its new construction rating.
- Insulated roof systems certified for use over noncombustible deck may be used over any type of Class A, B or C existing roof systems. The resultant Class will be the lesser rating of the existing system or the new construction (recover) system.
- Uninsulated multiple-layered hot mopped, cold application or modified bitumen membrane new construction systems with a base ply of Type G1 or Type G2 may be used over any existing uninsulated roof system and maintain its new construction rating.

General Notations

- PLEASE NOTE:** Not all UL-rated assemblies that use Holcim Solutions and Products US, LLC. are eligible for the Red Shield, Red Shield Medallion, or Platinum Warranty. The Holcim standards, guidelines, and specifications regarding roofing system components and attachment for the warranty desired must be followed.
- If a discrepancy occurs between this guide and UL Certifications, the published information located in the UL Certifications Directory at <https://productiq.ulprospector.com> should be adhered to and utilized.
- Noncombustible decks Classifications are acceptable for use over combustible (15/32" minimum plywood) decks when .5" gypsum board or .25" DensDeck® are used directly over the deck with all joints staggered 6" minimum from plywood joints.
- The below stated assemblies may not be suitable for a Red Shield Warranty. Prior to installation, contact a Holcim Representative for approval of assembly for warranty purposes.
- HAILGARD™/ISOGARD™ HG Insulation is an acceptable alternative to all insulations in the following Classifications except where DensDeck is stated.
- **Water Based Bonding Adhesive -P (WBBA-P) is an equivalent to Water Based Bonding Adhesive-R (WBBA-R) (no longer available**)
- ISO 95+ GL™ & ISOGARD GL is trademarked.

UL Certifications (TFGU.R9516)

NOTE: The UL assemblies listed below can be found on the UL Online Certification Direct report TGFU.R9516. You can click on the report number previously listed to open a hyperlink to the report.

The following table lists Holcim Solutions and Products US, LLC. Elevate Brand/Trade Name and the equivalent GenFlex Roofing Systems Brand/Trade Name and is an acceptable alternate to any applicable Classification below.

Trade Names	
Elevate	GenFlex
ISO 95+ GL or ISOGARD GL	GenFlex ISO Insulation or GenFlex GL ISO Insulation
RESISTA™ or ISOGARD CG	Coated Glass Facer or GenFlex CG ISO Insulation
ISOGARD™ HD Coverboard	GenFlex HD ISO
ISOGARD HD Composite	GenFlex HD ComplISO
HailGard™ Composite Board or ISOGARD HG	GenFlex HailGard or GenFlexISO HG
I.S.O. Stick	GenFlex ISO Bond Insulation Adhesive
I.S.O. Twin Pack Insulation Adhesive	GenFlex One Step Insulation Adhesive
Fire Retardant RubberGard™	GenFlex II FR
RubberGard Platinum	GenFlex AFR EPDM 90 mil
RubberGard LS-FR	GenFlex AFR

RubberGard LS-FR PT	GenFlex AFR PT
RubberGard MAX	GenFlex II FRM
RubberGard MAX PT	GenFlex II FRM PT
RubberGard MAX FR	GenFlex II FRM-FR
RubberGard EcoWhite™	GenFlex FlexWhite EPDM
BA 2004 (T) Bonding Adhesive	GenFlex EPDM Bonding Adhesive
Single-Ply LVOC Bonding Adhesive	GenFlex EPDM Bonding Adhesive LVOC/EZ UltraPly TPO Bonding Adhesive LVOC
Single-Ply LVOC Bonding Adhesive-1168	EPDM Bonding Adhesive LVOC 1168/EZ TPO Bonding Adhesive LVOC-1168
Water Based Bonding Adhesive-P	Water Based Bonding Adhesive (P)
RubberGard™ EPDM SA	GenFlex EZ EPDM Peel & Stick
RubberGard SA 1065 Splice Adhesive	GenSplice
RubberGard™ EPDM SA	Self-Adhered EPDM
QuickSeam Splice Tape	GenFlex Seam Tape
EcoWhite QuickSeam Splice Tape	GenFlex White Seam Tape
QuickSeam Batten Cover Strip	GenFlex Cover Tape
QuickPrime Plus Primer	GenPrime
Single-Ply LVOC Primer	All-Purpose LVOC Primer
UltraPly™ TPO	EZ TPO
UltraPly TPO XR 100	EZ Fleece Backed TPO (45 mil)
UltraPly TPO XR 115	EZ Fleece Backed TPO (60 mil)
UltraPly TPO XR 135	EZ Fleece Backed TPO (80 mil)
UltraPly TPO SA	EZ TPO Peel and Stick HW
PVC XR	N/A
PVC	N/A
PVC Water Based Bonding Adhesive	N/A
PVC LVOC Bonding Adhesive	N/A
PVC Bonding Adhesive	N/A
UltraPly Bonding Adhesive	EZ TPO Bonding Adhesive
XR Bonding Adhesive	Fleece Backed Bonding Adhesive
XR Stick Membrane Adhesive	EZ TPO FB Stick Adhesive
TPO QuickSeam Flashing	EZ Peel & Stick Flashing
UltraPly TPO QuickPrime	EZ Primer
V-Force	Vapor Shield Membrane
V-Force SB Primer	SA-Solvent Based (SB) Primer
SA-LVOC Primer	SA-LVOC Primer
Twin Jet	GenFlex Quick Dual

Elevate TPO – General Components

Assembly Number	Deck	Roofing System	Max. Slope	Class
1	NC	<p>Insulation: Any UL Classified, any thickness, adhered with Twin Jet or Quick Dual.</p> <p>Membrane: Any UL Classified modified bitumen system, BUR system or CPE, CSM, CSPE, EPDM, NBP, PIB, PVC, TPO or TRE membrane system suitable for use with any roof insulation</p> <p>NOTE 1: Classification (A, B or C) and maximum incline will be the same as that of the Classified Roofing System (TGfU) currently limited to noncombustible roof deck.</p>	See Note 1	A, B, or C See Note 1
2	NC	<p>Vapor Barrier (Optional): V-Force, Vapor Shield Membrane self-adhered.</p> <p>Roofing System: Any Insulated UL Classified modified bitumen system, BUR system, or CPE, CSM, CSPE, EPDM, NBP, PIB, PVC, TPO or TRE membrane system. Insulation may be adhered with I.S.O. Twin Pack, I.S.O. Twin Pack Green, I.S.O. Stick or I.S.O. Spray R or Twin Jet spray adhesive.</p> <p>NOTE 1: Classification (A, B or C) and maximum incline will be the same as that for the currently Classified insulated system, currently limited to a noncombustible roof deck.</p>	See Note 1	A, B, or C See Note 1
3	C-15/32	<p>Vapor Barrier (Optional): V-Force, Vapor Shield Membrane self-adhered.</p> <p>Insulation (Optional): ISO 95+ GL or ISOGARD GL any thickness.</p> <p>Barrier Board: Minimum ½" thick gypsum wallboard, or minimum ¼" thick Georgia-Pacific Gypsum LLC DensDeck Roof Board or DensDeck Prime Roof Board or DensDeck DuraGuard Roof Board, joints in barrier board offset 6" with joints in deck.</p> <p>Roofing System: Any Insulated UL Classified modified bitumen system, BUR system, or CPE, CSM, CSPE, EPDM, NBP, PIB, PVC, TPO or TRE membrane system. Insulation may be adhered or mechanically attached with I.S.O. Twin Pack, I.S.O. Twin Pack Green, I.S.O. Stick or I.S.O. Spray R or Twin Jet spray adhesive.</p> <p>NOTE 1: Classification (A, B or C) and maximum incline will be the same as that for the currently Classified insulated system, currently limited to a combustibile roof deck.</p>	See Note 1	A, B, or C See Note 1
4	C-15/32	<p>Vapor Barrier (Optional): V-Force, Vapor Shield Membrane self-adhered.</p> <p>Insulation (Optional): ISO 95+ GL or ISOGARD GL any thickness.</p> <p>Insulation: 1" minimum thickness RESISTA or ISOGARD CG, joints in insulation board offset 6" with joints in deck.</p> <p>Roofing System: Any Insulated UL Classified modified bitumen system, BUR system, or CPE, CSM, CSPE, EPDM, NBP, PIB, PVC, TPO or TRE membrane system. Insulation may be adhered or mechanically attached with I.S.O. Twin Pack, I.S.O. Twin Pack Green, I.S.O. Stick or I.S.O. Spray R or Twin Jet spray adhesive.</p> <p>NOTE 1: Classification (A, B or C) and maximum incline will be the same as that for the currently Classified insulated system, currently limited to a combustibile roof deck.</p>	See Note 1	A, B, or C See Note 1
5	NC	<p>Insulation: Any UL Classified, any thickness, adhered with I.S.O. Twin Pack, ISO Twin Pack Green, I.S.O. Stick or I.S.O. Spray R or Twin Jet spray adhesive.</p> <p>Membrane: Any UL Classified modified bitumen system, BUR system or CPE, CSM, CSPE, EPDM, NBP, PIB, PVC, TPO or TRE membrane system suitable for use with any roof insulation.</p> <p>NOTE 1: Classification (A, B or C) and maximum incline will be the same as that of the Classified Roofing System (TGfU) currently limited to noncombustible roof deck.</p>	See Note 1	A, B, or C See Note 1
6	C-15/32	<p>Insulation: Any UL Classified, any thickness, adhered with I.S.O. Twin Pack, ISO Twin Pack Green, I.S.O. Stick or I.S.O. Spray R or Twin Jet spray adhesive.</p> <p>Barrier Board: Minimum ½" thick gypsum wallboard, or minimum ¼" thick Georgia-Pacific Gypsum LLC DensDeck Roof Board or DensDeck Prime Roof Board or DensDeck DuraGuard Roof Board, joints in barrier board offset 6" with joints in deck.</p> <p>Membrane: Any UL Classified modified bitumen system, BUR system or CPE, CSM, CSPE, EPDM, NBP, PIB, PVC, TPO or TRE membrane system suitable for use with any roof insulation.</p> <p>NOTE 1: Classification (A, B or C) and maximum incline will be the same as that of the Classified Roofing System (TGfU) currently limited to combustibile roof deck.</p>	See Note 1	A, B, or C See Note 1

RubberGard EPDM - Ballasted

General Notes

1. Unless otherwise indicated, the insulation and membrane are laid loosely.
2. As an alternate, the insulation may be mechanically fastened to the deck with screws and metal or plastic discs, hot roofing asphalt or a combination of screws/discs and hot roofing asphalt.
3. An optional layer of gypsum board may be placed between the insulation and the roof deck on all systems.
4. As an alternate, a Elevate "Ballast Paver" system may be used in lieu of ballast and maintain the Classification of any Classified ballasted assembly.
5. As an alternate, river bottom or crushed stone conforming to ASTM D-448 No. 3 or 24 may be used in lieu of the No. 4 stone applied at 1000 lb/100 ft² (minimum).
6. As an alternate, river bottom or crushed stone conforming to ASTM D-448 No. 1 or 2 may be used in lieu of the No. 4 stone applied at 1300 lb/100 ft² (minimum).
7. Optional) Noncombustible roof deck Classifications are applicable for use over combustible (15/32" minimum plywood) roof decks when minimum 1/2" thick gypsum board or minimum 1/4" thick Georgia-Pacific Gypsum LLC "DensDeck Roof Board" or "DensDeck Prime Roof Board" or "DensDeck DuraGuard Roof Board" are used directly over the deck with all joints staggered a minimum of 6" from plywood roof deck butt joints.
8. Fire Retardant Reinforced or RubberGard MAX FR EPDM membrane is an acceptable alternate to Fire Retardant RubberGard in all applicable Classifications.

Elevate EPDM – Ballasted – Class A

Assembly Number	Deck	Roofing System	Max. Slope
1	C-15/32	<p>Insulation (Optional): Perlite, wood fiber, glass fiber, polyurethane, polyisocyanurate (including any ISO-95+ insulation), polystyrene (expanded or extruded), phenolic, perlite/urethane composite, perlite/polyisocyanurate or polystyrene/perlite composite, any combination, any thickness. NOTE: When Polystyrene is used on combustible roof decks, a layer of 1/2" thick minimum Johns Manville Retrofit Board, 1/2" thick minimum Gypsum Board (not UL Classified) or 3/4" perlite must be placed either above or below the polystyrene.</p> <p>Protective Mat (Optional): Exception: Non-insulated systems, polyester or polypropylene protective mat).</p> <p>Membrane: Fire Retardant RubberGard or any UL Classified Elevate membrane (EPDM).</p> <p>Surfacing: River bottom stone (3/4" to 1 1/2" diameter) at 1000 lb/100 ft².</p>	2"
2	C-15/32	<p>Insulation (Optional): Perlite, wood fiber, glass fiber, polyurethane, polyisocyanurate (including ISO 95+ GL), polystyrene (expanded or extruded), perlite/urethane composite, phenolic, perlite/polyisocyanurate composite, polystyrene/perlite composite, any combination, any thickness. NOTE: When polystyrene (expanded or extruded) is used on combustible roof decks a layer of 1/2" minimum Johns Manville Retrofit Board, 1/2" minimum Gypsum board (not UL Classified) or 3/4" perlite must be placed either above or below the polystyrene.</p> <p>Membrane: Fire Retardant RubberGard (EPDM) or any UL Classified Elevate membrane.</p> <p>Insulation: Dow Chemical STYROFOAM GRAYBOARD RM, PD, SM, TG, LG, STYRORIB.</p> <p>Slip Sheet (Optional): Fabrene or Rufon Polypropylene Scrim, 2 oz./100 ft² (maximum).</p> <p>Surfacing: — River bottom stone (3/4" to 1 1/2" diameter) at 1000 lb/100 ft², Dow Chemical plastic insulation panels surfaced with a minimum of 3/8" thick concrete mortar may be used in lieu of the river bottom stone. Mortar panels to be abutted together.</p>	2"
7	C-15/32	<p>Insulation (Optional): Perlite, glass fiber, wood fiber, isocyanurate, any ISO 95+ GL or ISOGARD GL insulation or any other UL Classified insulation, any combination.</p> <p>Base Sheet (Optional): Type G1, Type G2 or Type G3 or Elevate Protection Mat (not UL Classified).</p> <p>Membrane: APP 160, APP 160-P or APP 170 (modified bitumen), heat fused or any UL Classified PVC, EPDM, CPE, CSPE, TRE, nitrile alloy or modified bitumen.</p> <p>Insulation (Optional): Dow Chemical STYROFOAM RM, PD, SM, TG or STYRORIB, 1" minimum. When the insulation is applied in more than one layer, successive layers shall be installed without attachment to the preceding layer.</p> <p>Slip Sheet (Optional): Fiberglas mat may be laid between the insulation and membrane.</p> <p>Scrim (Optional): Fabrene, International Paper D689 or Rufon Polypropylene, 2 oz/yd² (not</p>	2"

		Classified). Surfacing: One of the following: a.) 900 lb/100 ft ² minimum of crushed stone or river bottom stone which is free from dirt and graded to a typical size of ¾" with a minimum of ½" for crushed stone and ¾" to 1 ¾" for river bottom stone. b.) Concrete blocks weighing not less than 10 lb/100 ft ² and spread not more than 1/8 in. apart.	
9	C-15/32	Insulation: Any ISO 95+ GL insulation, any thickness, loose laid or mechanically fastened. Membrane: Fire Retardant RubberGard (EPDM), 45 or 60 mil, UltraPly or UltraPly (TPO), any color, APP 160, APP 160-P, APP 170, (modified bitumen) or any UL Classified CPE, EPDM, LSPE, PVC, TRE, Nitrile alloy or modified bitumen, loose laid or mechanically fastened. Surfacing: River bottom stone (¾" to 1 ½" diameter), 1000 lbs/100 ft ² .	2"
12	NC	Insulation (Optional): Polystyrene (extruded or expanded) polyisocyanurate, glass fiber, perlite, wood fiber any combination and any thickness. Membrane: Any UL Elevate Classified EPDM or TPO membrane. EPDM splices may be primed with QuickPrime Plus, and seamed with SA-1065 Splice Adhesive, QuickSeam Splice Tape or EcoWhite QuickSeam Splice Tape. Seams may be covered with QuickSeam Flashing and or QuickSeam Batten Cover (or EcoWhite QuickSeam Flashing). Surfacing: River bottom stone (¾" to 1 ½" diameter) at 1000 lbs/100 ft ² .	2"
18	NC	Membrane: Any UL Classified PVC, EPDM, CPE, CSPE, TRE, nitrile alloy or modified bitumen, loose laid or mechanically fastened. Insulation: ISO 95+ CAN or ISOGARD GL. Surfacing: River bottom stone (¾" to 1 ¾" diameter) 1000 lb/100 ft ² .	3"
21	NC	Insulation: Polyisocyanurate, glass fiber, perlite, wood fiber, loose laid, mechanically fastened, any thickness. Membrane: Any UL Classified EPDM, adhered to insulation with PVC Bonding Adhesive bonding adhesives at 1 gal/100 ft ² Surfacing: River bottom stone (¾" to 1 ½" diameter) at 1000 lb/100 ft ²	2"

Elevate EcoWhite EPDM – Ballasted – Class A

Assembly Number	Deck	Roofing System	Max. Slope
12	NC	Insulation (Optional): Polystyrene (extruded or expanded) polyisocyanurate, glass fiber, perlite, wood fiber any combination and any thickness. Membrane Any UL Classified EPDM or TPO membrane. EPDM splices may be primed with QuickPrime™ Plus, and seamed with SA-1065 Splice Adhesive, QuickSeam Splice Tape or EcoWhite QuickSeam Splice Tape. Seams may be covered with QuickSeam Flashing and or QuickSeam Batten Cover (or EcoWhite QuickSeam Flashing). Surfacing: River bottom stone (¾" to 1 ½" diameter) at 1000 lbs/100 ft ² .	2"

RubberGard EPDM – Adhered Membrane

General Notes

1. Unless otherwise indicated, the EPDM membranes may be fully adhered with "BA-2004 (T) Bonding Adhesive", "Single-Ply LVOC Bonding Adhesive" "Single-Ply LVOC Bonding Adhesive- 1168" or "Single-Ply LVOC Flashing Adhesive - 1168" 1 gal/45-ft.2 finished application rate or " Elevate Water Based Bonding Adhesive P" which is applied at 1 gal/120-ft.2 total.
2. Noncombustible roof deck Classifications ("Fire Retardant RubberGard" systems excluded) are applicable for use over combustible (15/32" thick minimum plywood) roof decks when minimum ½" thick gypsum board or minimum ¼" thick Georgia-Pacific Gypsum LLC "DensDeck Roof Board" or "DensDeck Prime Roof Board" or "DensDeck DuraGuard Roof Board" are used directly over the roof deck with butt joints in the barrier board offset a minimum of 6" from the with the plywood butt joints in the roof deck.
3. RubberGard MAX FR EPDM membrane is an acceptable alternate to Fire Retardant RubberGard, and RubberGard MAX in all applicable Classifications.

RubberGard EPDM LS-FR – Adhered Membrane – Class A

Assembly Number	Deck	Roofing System	Max. Slope
21	NC	<p>Insulation Concrete: Deck covered with either of the following insulating concretes (poured in place): cellular, vermiculite, perlite, gypsum or structural. Optionally, a base concrete deck may be used if all exposed surface joints are grouted.</p> <p>Insulation (Optional): Wood fiber any UL Classified 1/2" minimum.</p> <p>Membrane: RubberGard LS-FR EPDM, 45 or 60 mil</p>	1"
22	C-15/32	<p>Insulation (Optional): ISO 95+ GL or EPS any thickness.</p> <p>Coverboard: 1/2" ISOGARD HD Coverboard</p> <p>Membrane: RubberGard LS-FR EPDM, 45 or 60 mil</p>	1/2"
79A	NC	<p>Insulation: ISOGARD GL ISO any thickness</p> <p>Membrane: RubberGard LS-FR (EPDM), 45 or 60 mil</p>	1/4"
80	NC	<p>Insulation (Optional): Any UL Classified, any thickness.</p> <p>Insulation: Wood fiberboard, 1/2" thick minimum.</p> <p>Membrane: RubberGard LS-FR (EPDM), 45 or 60 mil.</p>	3/4"
81	NC	<p>Insulation (Optional): ISO 95+ GL, wood fiberboard or perlite, any thickness.</p> <p>Membrane: RubberGard LS-FR (EPDM), 45 or 60 mil.</p>	1/2"
82	C-15/32	<p>Insulation (Optional): Any UL Classified, any thickness</p> <p>Barrier Board: Minimum 1/4" thick, DensDeck or DensDeck Prime or DensDeck Prime 2 with all joints staggered a minimum of 6" from the plywood joints.</p> <p>Membrane: RubberGard LS-FR (EPDM) adhered with BA 2004 (T) Bonding Adhesive, Single-Ply LVOC Bonding Adhesive, Single-Ply LVOC Bonding Adhesive-1168 or Water Base Bonding Adhesive-P.</p>	Unlimited
123	C-15/32	<p>Slip Sheet: Two layers VersaShield Underlayment or VersaShield FB-2S, preliminary attachment.</p> <p>Insulation: ISO 95+ GL (any thickness), mechanically attached.</p> <p>Membrane: .045 or .060; RubberGard LS-FR (1/2:12); EPDM membranes may be coated with AcryliTop PC-100 at 1 gal/100 ft² and maintain rating.</p>	See Listing
124	C-15/32	<p>Slip Sheet: Two layers VersaShield FB-1S, preliminary attachment.</p> <p>Insulation: ISO 95+ GL (any thickness), mechanically attached.</p> <p>Membrane: .045 or .060; RubberGard LS-FR (1/2:12); EPDM membranes may be coated with AcryliTop PC-100 at 1 gal/100 ft² and maintain rating.</p>	See Listing
155	NC	<p>Insulation (Optional): Any UL Classified polyisocyanurate, any thickness</p> <p>Insulation: Minimum 1/2-in. thick ISOGARD HD, minimum 1" thick ISOGARD HD Composite Board or 1/2" thick RESISTA or ISOGARD CG</p> <p>Membrane: RubberGard LS-FR, fully adhered with BA 2004 (T) Bonding Adhesive, Single-Ply LVOC Bonding Adhesive, Single-Ply LVOC Bonding Adhesive 1168 or Water Based Bonding Adhesive P.</p> <p>Surfacing (Optional): After the EPDM is allowed to weather for approximately two weeks, AcryliTop PC-100 at 1 gal/100 ft². Optional: General purpose or silica sand (sieve size of 50 to 100) may be applied into the wet coating at 35 lb/100 ft².</p>	1/2"
161	C-15/32	<p>Insulation (Optional): ISO 95+ GL or ISOGARD GL, any thickness</p> <p>Insulation: 1 in. minimum ISOGARD HD Composite Board or 1" thick RESISTA or ISOGARD CG offset 6" with joints in the deck.</p> <p>Membrane: RubberGard LS-FR, adhered with BA 2004 (T) Bonding Adhesive or Water Based Bonding Adhesive P.</p> <p>Surfacing (Optional): After the EPDM is allowed to weather for approximately two weeks, AcryliTop PC-100 at 1 gal/100 ft². Optional: General purpose or silica sand (sieve size of 50 to 100) may be applied into the wet coating at 35 lb/100 ft².</p>	1/2"
172	C-15/32	<p>Insulation (Optional): Any UL Classified, any thickness.</p> <p>Barrier Board: Minimum 1/4" thick DensDeck or DensDeck Prime</p> <p>Membrane: —RubberGard LS-FR, fully adhered with Modular Water Based Bonding Adhesive at 1 gal/100 ft².</p>	1/2"

RubberGard EPDM LS-FR – Adhered Membrane – Class A (Continued)

173	NC	Insulation (Optional): ISO 95 + GL or ISOGARD GL, any thickness. Membrane: RubberGard LS-FR, fully adhered with Modular Water Based Bonding Adhesive at 1 gal/100 ft ² or Water Based Bonding Adhesive P.	¼"
215	NC	Insulation (Optional): Any UL Classified, any thickness, any combination. Insulation: Wood fiber (Huebert), 1" thick. Membrane: RubberGard LS-FR 45 or 60 mil., adhered with EPDM Solvent-Free Bonding Adhesive, applied at 1 gal/150 ft ² .	½"
216	C-15/32	Insulation (Optional): Any UL Classified, any thickness, any combination. Barrier Board: Minimum ¼-in. thick DensDeck or DensDeck Prime Membrane: RubberGard™ LS-FR 45 or 60 mil., adhered with EPDM Solvent-Free Bonding Adhesive, applied at 1 gal/150 ft ² .	3"
217	NC	Insulation: ISO 95+ GL or ISOGARD GL, any thickness. Membrane: RubberGard LS-FR 45 or 60 mil., adhered with EPDM Solvent-Free Bonding Adhesive, applied at 1 gal/150 ft ² .	¼"

RubberGard EPDM LS-FR – Adhered Membrane – Class B

Assembly Number	Deck	Roofing System	Max. Slope
24	C-15/32	Base Sheet: One or more plies MB Base. Insulation: Minimum 1½" thick ISO 95+ GL or ISOGARD GL, minimum 1" thick UL Classified wood fiber or min. ½" thick UL Classified wood fiber over 1" thick ISO 95+ GL or ISOGARD GL. Membrane: RubberGard LS-FR (EPDM), 45 or 60 mil.	¼"
27	C-15/32	Insulation: Minimum 1" thick UL Classified wood fiber or minimum ½" thick UL Classified wood fiber over 1 ½" thick ISO 95+GL or ISOGARD GL. Membrane: RubberGard LS-FR, 45 or 60 mil.	¼"
36	C-15/32	Insulation (Optional): ISO 95+ GL or ISOGARD GL, any thickness Insulation: Minimum ½" thick ISOGARD HD, minimum 1" thick ISOGARD HD Composite Board or ½" thick RESISTA or ISOGARD CG with butt joints in the insulation offset a minimum of 6" from the with the plywood butt joints in the roof deck. Membrane: RubberGard LS-FR, adhered with BA-2004 (T) Bonding Adhesive or Water Based Bonding Adhesive P. Surfacing (Optional): After the EPDM is allowed to weather for approximately two weeks, AcryliTop PC-100 at 1 gal/100-ft.2. Optional: General purpose or silica sand (sieve size of 50 to 100) may be applied into the wet coating at 35 lb /100 ft ² .	½"
41	C-15/32	Insulation (Optional): ISO 95+ GL or ISOGARD GL, any thickness Insulation: Minimum ½" thick ISOGARD HD, minimum 1" thick ISOGARD HD Composite Board or ½" thick RESISTA or ISOGARD CG with butt joints in the insulation offset a minimum of 6" from the with the plywood butt joints in the roof deck. Membrane: RubberGard LS-FR, adhered with BA-2004 (T) Bonding Adhesive or WBBA P. Surfacing (Optional): After the EPDM is allowed to weather for approximately two weeks, AcryliTop PC-100 at 1 gal/100 ft ² . Optional: General purpose or silica sand (sieve size of 50 to 100) may be applied into the wet coating at 35 lb/100 ft ² .	¼"
44	NC	Insulation: ISO 95+ GL, ISOGARD GL, RESISTA, or ISOGARD CG, any thickness. Membrane: RubberGard LS-FR, 45 to 80 mil.	¼"
52	C-15/32	Insulation (Optional): Any UL Classified, any thickness, any combination. Barrier Board: Minimum ¼-in. thick DensDeck or DensDeck Prime Membrane: RubberGard LS-FR 45 or 60 mil., adhered with EPDM SFBA, applied at 1 gal/150-ft.2.	5"
53	NC	Insulation: ISO 95+ GL, any thickness. Membrane: RubberGard LS-FR 45 or 60 mil., adhered with EPDM Solvent-Free Bonding Adhesive, applied at 1 gal/150 ft ² .	½"
53A	C-15/32	Insulation (Optional): Any UL Classified, any thickness. Barrier Board: Minimum ¼" thick, DensDeck Membrane: RubberGard LS-FR (EPDM) adhered full coverage with Jet Bond Spray Adhesive, at a rate of 800 - 1000 ft ² per canister	2 ½"

RubberGard EPDM LS-FR – Adhered Membrane – Class C

Assembly Number	Deck	Roofing System	Max. Slope
18	C-15/32	Insulation: ISO 95+ GL or ISOGARD GL, 2" thick. Membrane: RubberGard LS-FR adhered with BA-2004 (T) Bonding Adhesive, 1 gal/45ft ² .	1/2"

RubberGard Platinum EPDM – Adhered Membrane – Class A

Assembly Number	Deck	Roofing System	Max. Slope
21	NC	Insulation Concrete: Deck covered with either of the following insulating concretes (poured in place): cellular, vermiculite, perlite, gypsum or structural. Optionally, a base concrete deck may be used if all exposed surface joints are grouted. Insulation (Optional): Wood fiber any UL Classified 1/2" minimum. Membrane: RubberGard Platinum EPDM, 90 mil.	1"
22	C-15/32	Insulation (Optional): ISO 95+GL or EPS any thickness. Cover Board: 1/2" ISOGARD HD Coverboard Membrane: RubberGard Platinum EPDM, 90mil.	1/2"
127	NC	Insulation: ISO 95+ GL, any thickness, mechanically fastened. Membrane: RubberGard Platinum (EPDM), fully adhered with BA 2004 (T) Bonding Adhesive, 1 gal/45 ft ² .	1/2"
128	NC	Insulation (Optional): Any UL Classified, any thickness, mechanically attached. Barrier Board: Minimum 1/4" thick DensDeck or DensDeck Prime mechanically fastened. Membrane: RubberGard Platinum (EPDM).	3 1/2"
129	NC	Insulation (Optional): ISO 95+GL or ISOGARD GL, any thickness, mechanically attached. Insulation: HailGard Composite Board Composite Board, minimum 1 1/2" thick, mechanically fastened. Membrane: RubberGard Platinum (EPDM)	2 1/2"
130	NC	Insulation: ISO 95+ GL, any thickness, mechanically fastened. Membrane: RubberGard Platinum. Surfacing: AcryliTop PC-100, 1 gal/100 ft ² .	2"
131	NC	Insulation (Optional): Any UL Classified, any thickness, mechanically attached. Barrier Board: Minimum 1/4" thick DensDeck or DensDeck Prime, mechanically fastened. Membrane: RubberGard Platinum. Surfacing: AcryliTop PC-100, 1 gal/100 ft ² .	Unlimited
132	NC	Insulation (Optional): ISO 95+GL or ISOGARD GL, any thickness, mechanically attached. Insulation: HailGard Composite Board Composite Board, minimum 1 1/2" thick, mechanically fastened. Membrane: RubberGard Platinum Surfacing: AcryliTop PC-100, 1 gal/100 ft ² .	Unlimited
155	NC	Insulation (Optional): Any UL Classified polyisocyanurate, any thickness Insulation: Minimum 1/2". thick ISOGARD HD, minimum 1" thick ISOGARD HD Composite Board or 1/2" thick RESISTA or ISOGARD CG Membrane: RubberGard Platinum fully adhered with BA 2004 (T) Bonding Adhesive, Single-Ply LVOC Bonding Adhesive, Single-Ply LVOC Bonding Adhesive -1168 or Water Based Bonding Adhesive P. Surfacing (Optional): After the EPDM is allowed to weather for approximately two weeks, AcryliTop PC-100 at 1 gal/100 ft ² . Optional: General purpose or silica sand (sieve size of 50 to 100) may be applied into the wet coating at 35 lb/100 ft ² .	1/2"
159	NC	Insulation (Optional): Any UL Classified polyisocyanurate, any thickness Insulation: Minimum 1/2" thick ISOGARD HD, minimum 1" thick ISOGARD HD Composite Board or 1/2" thick RESISTA or ISOGARD CG. Membrane: RubberGard Platinum EPDM, adhered with BA 2004 (T) Bonding Adhesive, Single-Ply LVOC Bonding Adhesive, Single-Ply LVOC Bonding Adhesive -1168 or Water Based Bonding Adhesive P. Surfacing: AcryliTop PC-100 coating, 1 gal/100 ft ²	3/4"

RubberGard Platinum EPDM – Adhered Membrane – Class A (Continued)

169	C-15/32	Insulation (Optional): Any UL Classified, any thickness. Barrier Board: Minimum ¼" thick Georgia-Pacific Gypsum LLC DensDeck or DensDeck Prime Membrane: RubberGard Platinum EPDM, fully adhered with Modular Water Based Bonding Adhesive at 1 gal./100 ft ² .	3 ½"
170	NC	Insulation (Optional): ISO 95 + GL, any thickness. Membrane: RubberGard Platinum fully adhered with Modular Water Based Bonding Adhesive at 1 gal./100 ft ² .	½"
171	NC	Insulation (Optional): ISO 95 + GL or ISOGARD GL, any thickness. Cover Board: ISOGARD HD minimum ½" thick or minimum 1" thick ISOGARD HD Composite Board. Membrane: RubberGard Platinum EPDM fully adhered with Modular Water Based Bonding Adhesive at 1 gal./100 ft ² .	¾"
215	NC	Insulation (Optional): Any UL Classified, any thickness, any combination. Insulation: Wood fiber (Huebert), 1" thick. Membrane: RubberGard Platinum, adhered with EPDM Solvent-Free Bonding Adhesive, applied at 1 gal/150 ft ² .	½"
216	C-15/32	Insulation (Optional): Any UL Classified, any thickness, any combination. Barrier Board: Minimum ¼" DensDeck or DensDeck Prime Membrane: RubberGard Platinum adhered with EPDM Solvent-Free Bonding Adhesive, applied at 1 gal/150 ft ² .	3"
217	NC	Insulation: ISO 95+ GL or ISOGARD GL, any thickness. Membrane: RubberGard Platinum adhered with EPDM Solvent-Free Bonding Adhesive, applied at 1 gal/150 ft ² .	¼"

RubberGard Platinum EPDM – Adhered Membrane – Class B

Assembly Number	Deck	Roofing System	Max. Slope
52	C-15/32	Insulation (Optional): Any UL Classified, any thickness, any combination. Barrier Board: Minimum ¼" thick DensDeck Roofboard or DensDeck Prime Membrane: RubberGard Platinum, adhered with EPDM Solvent-Free Bonding Adhesive, applied at 1 gal/150 ft ² .	5"
53	NC	Insulation: ISO 95+ GL, any thickness. Membrane: RubberGard™ Platinum, adhered with EPDM Solvent-Free Bonding Adhesive, applied at 1 gal/150 ft ² .	½"

Fire Retardant RubberGard EPDM – Adhered Membrane – Class A

Assembly Number	Deck	Roofing System	Max. Slope
7	NC	Insulation (Optional): Any combination of the following may be used with no max thickness: polystyrene (expanded or extruded), perlite, wood fiber, glass fiber, polyisocyanurate, polyurethane, phenolic. Insulation: Wood fiber any UL Classified ½ in. thick minimum. Membrane: Fire Retardant RubberGard (EPDM), 45 or 60 mil.	1 ½"
8	NC	Insulation: ISO 95+ GL, any thickness. Membrane: Fire Retardant RubberGard (EPDM), 45 or 60 mil.	1"
13	NC	Insulation (Optional): Perlite, wood fiber or glass fiber, no max thickness. Insulation: Wood fiber any UL Classified ½" thick minimum. Membrane: Fire Retardant RubberGard (EPDM), 45 or 60 mil.	2"
14	NC	Insulation (Optional): Polystyrene Dow Chemical STYROFOAM RM, PD, SM, TG, LG or STYORIB, extruded or expanded polystyrene, any thickness. Insulation: Wood fiber any UL Classified ½" thick minimum. Membrane: Fire Retardant RubberGard (EPDM), 45 or 60 mil.	2 ¼"

Fire Retardant RubberGard EPDM – Adhered Membrane – Class A (Continued)

15	NC	<p>Insulation (Optional): Polyisocyanurate, polyurethane, perlite/polyisocyanurate composite, perlite, wood fiber, glass fiber, phenolic, no max thickness.</p> <p>Insulation: Wood fiber any UL Classified ½" minimum.</p> <p>Membrane: Fire Retardant RubberGard (EPDM), 45 or 60 mil.</p>	2"
16	NC	<p>Insulating Concrete: Deck covered with either of the following insulating concretes (poured in place): cellular, vermiculite, perlite, gypsum or structural. Optionally, a base concrete deck may be used if all exposed surface joints are grouted.</p> <p>Insulation (Optional): Wood fiber any UL Classified, ½" thick minimum.</p> <p>Membrane: Fire Retardant RubberGard (EPDM), 45 or 60 mil.</p>	¼"
28	NC	<p>Insulation (Optional): Any UL Classified, any thickness.</p> <p>Barrier Board: Regular or water resistant wallboard, ½" nominal.</p> <p>Membrane: Fire Retardant RubberGard (EPDM) (45 or 60 mil).</p> <p>Surfacing: (Optional for Fire Retardant RubberGard). After the EPDM is allowed to weather for approximately two weeks, AcryliTop PC-100 at 1 gal/100 ft² optional: General purpose or silica sand (sieve size of 50 to 100) may be applied into the wet coating at 35 lb/100-ft².</p>	3 ½"
156	NC	<p>Insulation (Optional): Any UL Classified polyisocyanurate, any thickness</p> <p>Insulation: Minimum ½" thick ISOGARD HD, minimum 1" thick ISOGARD HD Composite Board or ½" thick RESISTA or ISOGARD CG.</p> <p>Membrane: Fire Retardant RubberGard EPDM fully adhered with BA 2004 (T) Bonding Adhesive, Single-Ply LVOC Bonding Adhesive or Single-Ply LVOC Bonding Adhesive -1168 or Water Based Bonding Adhesive P.</p> <p>Surfacing (Optional): After the EPDM is allowed to weather for approximately two weeks, AcryliTop PC-100 at 1 gal/100 ft². Optional: General purpose or silica sand (sieve size of 50 to 100) may be applied into the wet coating at 35 lb/100 ft².</p>	¾"
215	NC	<p>Insulation (Optional): Any UL Classified, any thickness, any combination.</p> <p>Insulation: Wood fiber (Huebert), 1" thick.</p> <p>Membrane: Fire Retardant RubberGard adhered with EPDM Solvent-Free Bonding Adhesive, applied at 1 gal/150-ft.2.</p>	½"
216	C-15/32	<p>Insulation (Optional): Any UL Classified, any thickness, any combination.</p> <p>Barrier Board: Minimum ¼-in. thick Georgia-Pacific Gypsum LLC DensDeck® Roofboard or DensDeck Prime® Roofboard or DensDeck DuraGuard Roofboard</p> <p>Membrane: Fire Retardant RubberGard adhered with EPDM Solvent-Free Bonding Adhesive, applied at 1 gal/150 ft².</p>	3"
217	NC	<p>Insulation: ISO 95+ GL or ISOGARD GL, any thickness.</p> <p>Membrane: Fire Retardant RubberGard adhered with EPDM Solvent-Free Bonding Adhesive, applied at 1 gal/150 ft².</p>	¼"

Fire Retardant RubberGard EPDM – Adhered Membrane – Class B

Assembly Number	Deck	Roofing System	Max. Slope
52	C-15/32	<p>Insulation (Optional): Any UL Classified, any thickness, any combination.</p> <p>Barrier Board: Minimum ¼" thick DensDeck Roofboard or DensDeck Prime Roofboard</p> <p>Membrane: Fire Retardant RubberGard with EPDM Solvent-Free Bonding Adhesive, applied at 1 gal/150-ft².</p>	5"
53	NC	<p>Insulation: ISO 95+ GL, any thickness.</p> <p>Membrane: Fire Retardant RubberGard adhered with EPDM Solvent-Free Bonding Adhesive, applied at 1 gal/150 ft².</p>	½"

RubberGard MAX, MAX PT and/or MAX FR – Adhered Membrane – Class A

Assembly Number	Deck	Roofing System	Max. Slope
20	C-15/32	Insulation (Optional): Isocyanurate, extruded or expanded polystyrene, phenolic, wood fiber, glass fiber or perlite, any thickness. Barrier Board: Minimum ¼" thick, DensDeck Roofboard or DensDeck Prime Roofboard or DensDeck Prime 2, joints in wallboard offset 6" with joints in deck. Membrane: RubberGard MAX FR	1 ½"
26	NC	Insulation (Optional): Any UL Classified, any thickness, any combination. Insulation: Wood fiber any UL Classified ½" minimum. Membrane: RubberGard MAX FR (EPDM).	2"
46	NC	Insulation (Optional): Any combination of the following may be used: Perlite, wood fiber, glass fiber, 3" thick maximum. Insulation: Wood fiber, ½" thick minimum. Membrane: RubberGard MAX, 45 or 60 mil.	1 ¼"
48	NC	Insulation: Atlas Roofing Corp. ACFoam II or Rmax Operating LLC Multi-Max, any thickness. Membrane: RubberGard MAX, 45 or 60 mil.	¼"
49	NC	Insulation: ISO 95+ GL, any thickness. Membrane: RubberGard MAX, 45 or 60 mil.	½"
50	NC	Insulation (Optional): Any UL Classified polyisocyanurate, phenolic, extruded or expanded polystyrene, any thickness. Insulation: Wood fiber any UL Classified ½" thick minimum. Membrane: RubberGard MAX, 45 or 60 mil.	1 ¼"
52	C-15/32	Insulation (Optional): Any UL Classified, any thickness. Barrier Board: Water resistant wallboard, ½" nominal, joints in wallboard offset 6" with joints in deck. Insulation (Optional): Atlas Roofing Corp. ACFoam II, Rmax Operating LLC Multi-Max, ISO 95+ GL or ISOGARD GL, any thickness. Membrane: RubberGard MAX, 45 or 60 mil.	¼"
53	C-15/32	Barrier Board: Regular or water resistant wallboard, ½" thick nominal, joints in wallboard offset 6" with joints in deck. Insulation (Optional): Any combination of the following may be used: Perlite, wood fiber, glass fiber, any thickness. Insulation: Wood fiber, ½" thick minimum. Membrane: RubberGard MAX, 45 or 60 mil.	¼"
66	NC	Insulation (Optional): Any combination of the following may be used with no max thickness: polystyrene (expanded or extruded), perlite, wood fiber, glass fiber, polyisocyanurate, polyurethane, phenolic. Insulation: Wood fiber any UL Classified ½" thick minimum. Membrane: RubberGard MAX FR, 45 or 60 mil.	2"
89	NC	Insulation (Optional): Any UL Classified, any thickness. Insulation: Wood fiberboard, ½" thick minimum or minimum ¼" thick DensDeck Roofboard, DensDeck Prime Roofboard or APA rated plywood or OSB board, 7/16" thick minimum. Membrane: RubberGard MAX FR, 45 or 60 mil.	Unlimited
90	NC	Insulation (Optional): Any UL Classified, any thickness. Insulation: Wood fiberboard, ½" thick minimum, DensDeck Roofboard or DensDeck Prime Roofboard, ¼" thick minimum, APA rated plywood or OSB board, 7/16" thick minimum. Membrane: RubberGard MAX FR (EPDM), 45 or 60 mil, adhered with Water Based Bonding Adhesive P.	3"
91	NC	Insulation (Optional): ISO 95 + GL, wood fiber, glass fiber or perlite, any thickness. Membrane: RubberGard MAX FR, 45 or 60 mil	3"
92	NC	Insulation (Optional): ISO 95 + GL, wood fiber, glass fiber or perlite, any thickness. Membrane: RubberGard MAX FR, 45 or 60 mil, adhered with Water Based Bonding Adhesive-P.	2 ½"

RubberGard MAX, MAX PT and/or MAX FR – Adhered Membrane – Class A (Continued)

93	C-15/32	<p>Barrier Board: Gypsum board, 1/2" thick minimum or minimum 1/4" thick DensDeck Roofboard or DensDeck Prime Roofboard.</p> <p>Insulation (Optional): Any UL Classified, any thickness.</p> <p>Insulation: Wood fiberboard, 1/2" thick minimum or minimum 1/4" thick DensDeck Roofboard or DensDeck Prime Roofboard, APA rated plywood or OSB board, 7/16" thick minimum.</p> <p>Membrane: RubberGard MAX FR, 45 or 60 mil.</p>	Unlimited
94	C-15/32	<p>Barrier Board: Gypsum board, 1/2" thick minimum or Minimum 1/4" thick DensDeck Roofboard or DensDeck Prime Roofboard.</p> <p>Insulation (Optional): Any UL Classified, any thickness.</p> <p>Insulation: Wood fiberboard, 1/2" thick minimum or minimum 1/4" thick Georgia-Pacific Gypsum LLC DensDeck Roofboard or DensDeck Prime Roofboard or DensDeck DuraGuard Roofboard, APA rated plywood or OSB board, 7/16" thick min.</p> <p>Membrane: RubberGard MAX FR, 45 or 60 mil, adhered with Water Based Bonding Adhesive P.</p>	3"
95	C-15/32	<p>Barrier Board: Gypsum board, 1/2" thick min or minimum 1/4" thick DensDeck Roofboard or DensDeck Prime Roofboard.</p> <p>Insulation (Optional): ISO 95+ GL, wood fiber, glass fiber or perlite, any thickness.</p> <p>Membrane: RubberGard MAX FR, 45 or 60 mil.</p>	3"
96	C-15/32	<p>Barrier Board: Gypsum board, 1/2" thick minimum or minimum 1/4" thick DensDeck Roofboard or DensDeck Prime Roofboard.</p> <p>Insulation (Optional): ISO 95+ GL, wood fiber, glass fiber or perlite, any thickness.</p> <p>Membrane: RubberGard MAX FR, 45 or 60 mil, adhered with Water Based Bonding Adhesive-P.</p>	2 1/2"
109	NC	<p>Insulation (Optional): Any combination of the following may be used: Perlite, wood fiber, glass fiber, 3" maximum</p> <p>Insulation: Wood fiber, 1/2" minimum.</p> <p>Membrane: RubberGard MAX, 45 or 60 mil.</p>	1 1/4"
110	NC	<p>Insulation Concrete: Deck covered with either of the following insulating concretes (poured in place): Cellular, vermiculite, perlite, gypsum or structural. Optionally, a base concrete deck may be used if all exposed surface joints are grouted.</p> <p>Insulation (Optional): Wood fiber any UL Classified asphalt side down, 1/2" max.</p> <p>Membrane: RubberGard MAX (EPDM), 45, 60 or 75 mil.</p>	1 1/4"
112	NC	<p>Insulation: ISO 95+ GL, any thickness.</p> <p>Membrane: RubberGard MAX, 45, 60 or 75 mil.</p>	1/2"
113	NC	<p>Insulation (Optional): Any UL Classified polyisocyanurate, phenolic, extruded or expanded polystyrene, any thickness.</p> <p>Insulation: Wood fiber any UL Classified, 1/2" thick minimum.</p> <p>Membrane: RubberGard MAX, 45, 60 or 75 mil.</p>	1 1/4"
116	C-15/32	<p>Barrier Board: Regular or water resistant wallboard, 1/2" nominal, joints in wallboard offset 6" with joints in deck.</p> <p>Insulation (Optional): Any combination of the following may be used: Perlite, wood fiber, glass fiber, any thickness.</p> <p>Insulation: Wood fiber, 1/2" minimum.</p> <p>Membrane: RubberGard MAX, 45, 60 or 75 mil.</p>	1/4"
123	C-15/32	<p>Slip Sheet: Two layers VersaShield Underlayment or VersaShield FB-2S, preliminary attachment.</p> <p>Insulation: ISO 95+ GL (any thickness), mechanically attached.</p> <p>Membrane: .045 or .060; RubberGard LS-FR (1/2:12); RubberGard MAX (1/2:12); RubberGard MAX FR (1 1/2:12); UltraPly TPO (1/2 :12); EPDM membranes may be coated with AcryliTop PC-100 at 1 gal/100 ft² and maintain rating.</p>	See Membrane
124	C-15/32	<p>Slip Sheet: Two layers VersaShield FB-1S, preliminary attachment.</p> <p>Insulation: ISO 95+ GL (any thickness), mechanically attached.</p> <p>Membrane: RubberGard MAX or 75 mil (1/2:12); RubberGard MAX FR (3/4:12); membranes may be coated with AcryliTop PC-100 at 1 gal/100 ft² and maintain rating.</p>	See Membrane

RubberGard MAX, MAX PT and/or MAX FR – Adhered Membrane – Class A (Continued)

155	NC	<p>Insulation (Optional): Any UL Classified polyisocyanurate, any thickness</p> <p>Insulation: Minimum 1/2" thick ISOGARD HD, minimum 1" thick ISOGARD HD Composite Board or 1/2" thick RESISTA or ISOGARD CG</p> <p>Membrane: RubberGard Max, fully adhered with BA 2004 (T) Bonding Adhesive, Single-Ply LVOC Bonding Adhesive, Single-Ply LVOC Bonding Adhesive -1168 or Water Based Bonding Adhesive P.</p> <p>Surfacing (Optional): After the EPDM is allowed to weather for approximately two weeks, AcryliTop PC-100 at 1 gal/100 ft². Optional: General purpose or silica sand (sieve size of 50 to 100) may be applied into the wet coating at 35 lb/100 ft².</p>	1/2"
158	NC	<p>Insulation (Optional): Any UL Classified polyisocyanurate, any thickness</p> <p>Insulation: Minimum 1/2" ISOGARD HD, minimum 1" thick ISOGARD HD Composite Board or 1/2" thick RESISTA or ISOGARD CG.</p> <p>Membrane: RubberGard Max FR fully adhered with BA 2004 (T) Bonding Adhesive, Single-Ply LVOC Bonding Adhesive, Single-Ply LVOC Bonding Adhesive -1168 or Water Based Bonding Adhesive P.</p> <p>Surfacing (Optional): After the EPDM is allowed to weather for approximately two weeks, AcryliTop PC-100 at 1 gal/100 ft². Optional: General purpose or silica sand (sieve size of 50 to 100) may be applied into the wet coating at 35 lb/100 ft².</p>	3/4"
161	C-15/32	<p>Insulation (Optional): ISO 95+ GL or ISOGARD GL, any thickness</p> <p>Insulation: 1" minimum ISOGARD HD Composite Board or 1" thick RESISTA or ISOGARD CG offset 6" with joints in the deck.</p> <p>Membrane: RubberGard MAX, RubberGard MAX FR, adhered with BA 2004 (T) Bonding Adhesive or Water Based Bonding Adhesive P.</p> <p>Surfacing (Optional): After the EPDM is allowed to weather for approximately two weeks, AcryliTop PC-100 at 1 gal/100 ft². Optional: General purpose or silica sand (sieve size of 50 to 100) may be applied into the wet coating at 35 lb/100 ft².</p>	1/2"
172	C-15/32	<p>Insulation: (Optional) Any UL Classified, any thickness.</p> <p>Barrier Board: Minimum 1/4" thick DensDeck Roofboard or DensDeck Prime Roofboard.</p> <p>Membrane: RubberGard MAX, RubberGard MAX FR fully adhered with Modular Water Based Bonding Adhesive at 1 gal/100 ft².</p>	1/2"
173	NC	<p>Insulation (Optional): ISO 95 + GL or ISOGARD GL, any thickness.</p> <p>Membrane: RubberGard MAX, RubberGard MAX FR fully adhered with Modular Water Based Bonding Adhesive at 1 gal/100 ft² or Water Based Bonding Adhesive P.</p>	1/4"
215	NC	<p>Insulation (Optional): Any UL Classified, any thickness, any combination.</p> <p>Insulation: Wood fiber (Huebert), 1" thick.</p> <p>Membrane: RubberGard MAX, RubberGard MAX FR, Fire Retardant RubberGard or RubberGard EcoWhite (EPDM) adhered with EPDM Solvent-Free Bonding Adhesive, applied at 1 gal/150ft².</p>	1/2"
216	C-15/32	<p>Insulation (Optional): Any UL Classified, any thickness, any combination.</p> <p>Barrier Board: Minimum 1/4" thick DensDeck Roofboard or DensDeck Prime Roofboard</p> <p>Membrane: MAX, RubberGard MAX FR, adhered with EPDM Solvent-Free Bonding Adhesive, applied at 1 gal/150 ft².</p>	3"
217	NC	<p>Insulation: ISO 95+ GL or ISOGARD GL, any thickness.</p> <p>Membrane: RubberGard MAX, RubberGard MAX FR, adhered with EPDM Solvent-Free Bonding Adhesive, applied at 1 gal/150 ft².</p>	1/4"

RubberGard MAX, MAX PT and/or MAX FR – Adhered Membrane – Class B

Assembly Number	Deck	Roofing System	Max. Slope
23	C-15/32	Base Sheet: One or more plies MB Base. Insulation: Minimum 1 1/2" thick ISO 95+ GL, minimum 1" thick UL Classified wood fiber or minimum 1/2" thick UL Classified wood fiber over 1" thick ISO 95+ GL or ISOGARD GL. Membrane: RubberGard MAX, 45, 60 or 75 mil.	1/2"
25	C-15/32	Base Sheet: One or more plies MB Base. Insulation: Minimum 1 1/2" thick ISO 95+ GL, minimum 1" thick UL Classified wood fiber or minimum 1/2" thick UL Classified wood fiber over 1" thick ISO 95+ GL or ISOGARD GL. Membrane: RubberGard MAX FR, 45 or 60 mil.	1"
26	C-15/32	Insulation: Minimum 1" thick UL Classified wood fiber or minimum 1/2" thick UL Classified wood fiber over 1 1/2" thick ISO 95+ GL or ISOGARD GL. Membrane: RubberGard MAX, 45, 60 or 75 mil.	1/2"
28	C-15/32	Base Sheet: One or more plies MB Base. Insulation: Minimum 2" thick ISO 95+ GL, minimum 1" thick UL Classified wood fiber or minimum 1/2" thick UL Classified wood fiber over 1 1/2" thick ISO 95+ GL or ISOGARD GL. Membrane: RubberGard MAX FR, 45 or 60 mil.	1"
36	C-15/32	Insulation (Optional): ISO 95+ GL or ISOGARD GL, any thickness Insulation: Minimum 1/2" thick ISOGARD HD, minimum 1" thick ISOGARD HD Composite Board or 1/2" RESISTA or ISOGARD CG with butt joints in the insulation offset a minimum of 6" from the with the plywood butt joints in the roof deck. Membrane: RubberGard MAX or RubberGard MAX FR adhered with BA-2004 (T) Bonding Adhesive or Water Based Bonding Adhesive P. Surfacing (Optional): After the EPDM is allowed to weather for approximately two weeks, AcryliTop PC-100 at 1 gal/100 ft ² . Optional: General purpose or silica sand (sieve size of 50 to 100) may be applied into the wet coating at 35 lb/100 ft ²	1/2"
41	C-15/32	Insulation (Optional): ISO 95 + GL or ISOGARD GL, any thickness. Cover Board: Minimum 1/2" thick ISOGARD HD or 1" thick ISOGARD HD Composite Board. Membrane: RubberGard Max or RubberGard MAX FR fully adhered with Modular Water Based Bonding Adhesive at 1 gal/100 ft ² .	1/4"
52	C-15/32	Insulation (Optional): Any UL Classified, any thickness, any combination. Barrier Board: Minimum 1/4". thick DensDeck Roofboard or DensDeck Prime Roofboard Membrane: 45 or 60 mil., RubberGard MAX, RubberGard MAX FR, adhered with EPDM Solvent-Free Bonding Adhesive, applied at 1 gal/150 ft ² .	5"
53	NC	Insulation: ISO 95+ GL, any thickness. Membrane: 45 or 60 mil., RubberGard MAX, RubberGard MAX FR, adhered with EPDM Solvent-Free Bonding Adhesive, applied at 1 gal/150 ft ² .	1/2"

RubberGard EPDM SA – Self Adhered Membrane – Class A

Assembly Number	Deck	Roofing System	Max. Slope
181	C-15/32	Insulation (Optional): Any UL Classified any thickness Barrier Board: Minimum 1/4-in. DensDeck Roofboard or DensDeck Prime Roofboard or DensDeck DuraGuard Roofboard Membrane: RubberGard EPDM SA, 45 to 80 mil.	2"
181A	NC	Insulation: ISO 95 + GL or ISOGARD GL, any thickness. Membrane: RubberGard EPDM SA, 45 to 80 mil.	1/4"
181B	NC	Insulation: ISO 95 + GL or ISOGARD GL, any thickness Cover Board: ISOGARD HD 1/2" minimum. Membrane: RubberGard EPDM SA, 45 to 80 mil.	1/2"
181E	C-15/32	Insulation: RESISTA or ISOGARD CG minimum 2". Membrane: RubberGard EPDM SA, 45 to 80 mil.	1/4"

RubberGard EPDM SA – Self Adhered Membrane – Class B

Assembly Number	Deck	Roofing System	Max. Slope
44	NC	Insulation: ISO 95+ GL, ISOGARD GL, RESISTA or ISOGARD CG, any thickness. Membrane: RubberGard LS-FR, RubberGard EPDM, 45 to 80 mil.	1/4"
46	NC	Insulation: ISO 95 + GL, RESISTA or ISOGARD CG, any thickness. Membrane: RubberGard EPDM SA, 45 to 80 mil.	1/2"

RubberGard EcoWhite EPDM – Adhered Membrane – Class A

Assembly Number	Deck	Roofing System	Max. Slope
145	NC	Insulation: Wood fiber, 1/2" thick minimum. Membrane: RubberGard EcoWhite (EPDM), 60 or 90 mil	1"
146	NC	Insulation: Wood fiber, 1/2" thick minimum. Membrane: RubberGard EcoWhite (EPDM), 60 or 90 mil, fully adhered with Water Based Bonding Adhesive P applied at 1 gal/125 ft ² .	1"
147	NC	Insulation: ISO 95+GL, any thickness. Membrane: RubberGard EcoWhite (EPDM), 60 or 90 mil, fully adhered with Water Based Bonding Adhesive P applied at 1 gal/125 ft ² .	3/4"
148	C-15/32	Barrier Board: Minimum 1/4" thick Roofboard or DensDeck Prime Roofboard or DensDeck Membrane: RubberGard EcoWhite (EPDM), 60 or 90 mil.	1 1/2"
149	NC	Barrier Board: Minimum 1/4" thick DensDeck Roofboard or DensDeck Prime Roofboard. Membrane: RubberGard EcoWhite (EPDM), 60 or 90 mil, fully adhered with Water Based Bonding Adhesive P applied at 1 gal/125 ft ² .	1 1/2"
150	NC	Cover Board: Oriented strand board, minimum 7/16" thick, mechanically fastened. Membrane: RubberGard EcoWhite (EPDM), 60 or 90 mil.	1"
151	NC	Cover Board: Oriented strand board, minimum 7/16" thick, mechanically fastened. Membrane: RubberGard EcoWhite (EPDM), 60 or 90 mil, fully adhered with Water Based Bonding Adhesive P applied at 1 gal/125 ft ² .	1"
156	NC	Insulation (Optional): Any UL Classified polyisocyanurate, any thickness Insulation: Minimum 1/2" thick ISOGARD HD, minimum 1" thick ISOGARD HD Composite Board or 1/2" thick RESISTA or ISOGARD CG. Membrane: RubberGard EcoWhite fully adhered with BA 2004 (T) Bonding Adhesive, Single-Ply LVOC Bonding Adhesive or Single-Ply LVOC Bonding Adhesive 1168 or Water Based Bonding Adhesive P. Surfacing (Optional): After the EPDM is allowed to weather for approximately two weeks, AcryliTop PC-100 at 1 gal/100 ft ² . Optional: General purpose or silica sand (sieve size of 50 to 100) may be applied into the wet coating at 35 lb/100ft ² .	3/4"
161	C-15/32	Insulation (Optional): ISO 95+ GL or ISOGARD GL, any thickness Insulation: 1" minimum ISOGARD HD Composite Board or 1" thick RESISTA or ISOGARD CG offset 6" with joints in the deck. Membrane: RubberGard EcoWhite, adhered with BA 2004 (T) Bonding Adhesive or Water Based Bonding Adhesive P. Surfacing (Optional): After the EPDM is allowed to weather for approximately two weeks, AcryliTop PC-100 at 1 gal/100 ft ² . Optional: General purpose or silica sand (sieve size of 50 to 100) may be applied into the wet coating at 35 lb/100 ft ² .	1/2"
168	NC	Insulation (Optional): ISO 95+ GL, any thickness Membrane: RubberGard EcoWhite (EPDM), 45 to 90 mil.	3/4"
172	C-15/32	Insulation: (Optional) Any UL Classified, any thickness. Barrier Board: Minimum 1/4" thick DensDeck Roofboard or DensDeck Prime Membrane: RubberGard EcoWhite, fully adhered with Modular Water Based Bonding Adhesive at 1 gal/100 ft ² .	1/2"
173	NC	Insulation (Optional): ISO 95 + GL or ISOGARD GL, any thickness. Membrane: RubberGard EcoWhite, adhered with Modular Water Based Bonding Adhesive at 1 gal/100 ft ² or Water Based Bonding Adhesive P.	1/4"

RubberGard EcoWhite EPDM – Adhered Membrane – Class A (Continued)

215	NC	Insulation (Optional): Any UL Classified, any thickness, any combination. Insulation: Wood fiber (Huebert), 1 in. thick. Membrane: 45 or 60 mil RubberGard EcoWhite (EPDM) adhered with EPDM Solvent-Free Bonding Adhesive, applied at 1 gal/150 ft ² .	1/2"
216	C-15/32	Insulation (Optional): Any UL Classified, any thickness, any combination. Barrier Board: Minimum 1/4" thick DensDeck Roofboard or DensDeck Prime Roofboard Membrane: FR 45 or 60 mil., RubberGard EcoWhite (EPDM) adhered with EPDM Solvent-Free Bonding Adhesive, applied at 1 gal/150 ft ² .	3"
217	NC	Insulation: ISO 95+ GL or ISOGARD GL, any thickness. Membrane: 45 or 60 mil., RubberGard EcoWhite (EPDM) adhered with EPDM Solvent-Free Bonding Adhesive, applied at 1 gal/150 ft ² .	1/4"

RubberGard EcoWhite EPDM – Adhered Membrane – Class B

Assembly Number	Deck	Roofing System	Max. Slope
36	C-15/32	Insulation (Optional): ISO 95+ GL or ISOGARD GL, any thickness Insulation: Minimum 1/2" thick ISOGARD HD, minimum 1" thick ISOGARD HD Composite Board or 1/2" thick RESISTA or ISOGARD CG with butt joints in the insulation offset a minimum of 6" from the with the plywood butt joints in the roof deck. Membrane: RubberGard EcoWhite, adhered with BA-2004 (T) Bonding Adhesive or Water Based Bonding Adhesive P. Surfacing (Optional): After the EPDM is allowed to weather for approximately two weeks, AcryliTop PC-100 at 1 gal/100 ft ² . Optional: General purpose or silica sand (sieve size of 50 to 100) may be applied into the wet coating at 35 lb/100 ft ²	1/2"
41	C-15/32	Insulation: (Optional) ISO 95 + GL or ISOGARD GL, any thickness. Cover Board: Minimum 1/2" thick ISOGARD HD or 1" thick ISOGARD HD Composite Board. Membrane: RubberGard EcoWhite fully adhered with Modular Water Based Bonding Adhesive at 1 gal./100 ft ²	1/4"
52	C-15/32	Insulation (Optional): Any UL Classified, any thickness, any combination. Barrier Board: Minimum 1/4" thick DensDeck or DensDeck Prime Membrane: 45 or 60 mil., RubberGard EcoWhite (EPDM) adhered with EPDM Solvent-Free Bonding Adhesive, applied at 1 gal/150 ft ²	5"
53	NC	Insulation: ISO 95+ GL, any thickness. Membrane: 45 or 60 mil., RubberGard EcoWhite (EPDM) adhered with EPDM Solvent-Free Bonding Adhesive, applied at 1 gal/150 ft ²	1/2"

RubberGard EPDM – Adhered Membrane

RubberGard LS-FR EPDM – Attached Membrane – Class A

Assembly Number	Deck	Roofing System	Max. Slope
49	NC	Insulation: ISOGARD GL ISO, any thickness Membrane: RubberGard LS-FR (EPDM), 45 or 60 mil.	1/4"
53	NC	Insulation: ISO 95+ GL, wood fiber or perlite, any thickness. Membrane: RubberGard LS-FR (EPDM), 45 or 60 mil.	1/2"
55	NC	Insulation (Optional): — Any UL Classified, any thickness. Insulation: Minimum 1/2" thick wood fiberboard Membrane: RubberGard LS-FR (EPDM), 45 or 60 mil.	3/4"
63	C-15/32	Slip Sheet: Two or more plies Atlas Roofing Corp. Roofing FR 50, mechanically fastened. Membrane: LS-FR RubberGard (EPDM), 45 or 60 mil.	1/2"
75	C-15/32	Slip Sheet: Two layers GAF VersaShield Underlayment or VersaShield FB-2S, preliminary attachment. Membrane: .045 or .060; RubberGard LS-FR (1/2:12); EPDM membranes may be coated with AcryliTop PC-100 at 1 gal/100 ft ² and maintain rating.	See Membrane

RubberGard LS-FR EPDM – Attached Membrane – Class A (Continued)

76	C-15/32	<p>Slip Sheet: Two layers GAF VersaShield Underlayment or VersaShield FB-2S, preliminary attachment.</p> <p>Insulation: ISO 95+ GL (any thickness), preliminary attachment.</p> <p>Membrane:.045 or .060; RubberGard LS-FR (1/2:12); EPDM membranes may be coated with AcryliTop PC-100 at 1 gal/100 ft² and maintain rating.</p>	See Membrane
77	C-15/32	<p>Slip Sheet: Two layers GAF VersaShield FB-1S, preliminary attachment.</p> <p>Insulation (Optional): ISO 95+ GL (any thickness), preliminary attachment.</p> <p>Membrane:.045 or .060; RubberGard LS-FR (1/2:12); EPDM membranes may be coated with AcryliTop PC-100 at 1 gal/100 ft² and maintain rating.</p>	See Membrane
86	C-15/32	<p>Insulation (Optional): ISO 95+ GL or ISOGARD GL, any thickness.</p> <p>Insulation: ISOGARD HD Composite Board or RESISTA or ISOGARD CG with butt joints in the insulation offset a minimum of 6" from the with the plywood butt joints in the roof deck.</p> <p>Membrane: RubberGard LS-FR, mechanically attached.</p> <p>Surfacing (Optional): After the EPDM is allowed to weather for approximately two weeks, AcryliTop PC-100 at 1 gal/100 ft². Optional: General purpose or silica sand (sieve size of 50 to 100) may be applied into the wet coating at 35 lb./100 ft².</p>	1/2"

RubberGard LS-FR EPDM – Attached Membrane – Class B

Assembly Number	Deck	Roofing System	Max. Slope
2	NC	<p>Insulation: ISOGARD GL ISO any thickness</p> <p>Membrane: RubberGard LS-FR, 45 or 60 mil</p>	1/2"
3	C-15/32	<p>Slip Sheet: One layer Atlas Roofing Corp. FR 50</p> <p>Membrane: RubberGard LS-FR, 45 or 60 mil</p>	1/2"
7	C-15/32	<p>Base Sheet: One or more plies MB Base Sheet</p> <p>Insulation: Minimum 1 1/2" thick ISO 95+GL or minimum 1" thick FiberTop B or minimum 1/2" thick any UL Classified wood fiber over 1" thick ISO 95+ GL or ISOGARD GL</p> <p>Membrane: LS-FR, 45 or 60 mil</p>	1/4"
12	C-15/32	<p>Slip Sheet: One layer GAF VersaShield Underlayment or VersaShield FB-2S, preliminary attachment.</p> <p>Membrane: .045 or .060; "RubberGard™ LS-FR" (1/2:12); EPDM membranes may be coated with AcryliTop PC-100 at 1 gal/100 ft² and maintain rating.</p>	See Membrane
14	C-15/32	<p>Insulation (Optional): ISO 95+ GL or ISOGARD GL, any thickness,</p> <p>Insulation: Minimum 1/2" thick ISOGARD HD or minimum 1" thick ISOGARD HD Composite Board or 1/2" thick RESISTA or ISOGARD CG with butt joints in the insulation offset a minimum of 6" from the plywood butt joints in the roof deck.</p> <p>Membrane: RubberGard LS-FR, mechanically attached.</p> <p>Surfacing (Optional): After the EPDM is allowed to weather for approximately two weeks, AcryliTop PC-100 at 1 gal/100 ft². Optional: General purpose or silica sand (sieve size of 50 to 100) may be applied into the wet coating at 35-lbs./100 ft²</p>	1/2"

RubberGard Platinum EPDM – Attached Membrane – Class A

Assembly Number	Deck	Roofing System	Max. Slope
12	C-15/32	<p>Insulation (Optional): ISO 95+ GL or EPS any thickness.</p> <p>Coverboard: 1/2" ISOGARD HD Coverboard</p> <p>Membrane: RubberGard, LS-FR EPDM, 45 or 60 mil, or RubberGard Platinum EPDM, 90 mil.</p>	1/2"

RubberGard MAX, MAX PT and/or MAX FR EPDM – Attached Membrane – Class A

Assembly Number	Deck	Roofing System	Max. Slope
21	C-15/32	Insulation (Optional): Any UL Classified, any thickness. Barrier Board: Minimum 1/2" thick water resistant wallboard, with butt joints in the barrier board offset a minimum of 6" from the with the plywood butt joints in the roof deck Membrane: RubberGard MAX FR (EPDM).	1 1/2"
23	C-15/32	Barrier Board: Minimum 1/2" thick water resistant or regular wallboard, with butt joints in the barrier board offset a minimum of 6" from the with the plywood butt joints in the roof deck. Insulation (Optional): Any combination of the following may be used: Perlite, wood fiber, glass fiber, 3" thick maximum. Insulation: Minimum 1/2" thick wood fiber. Membrane: RubberGard MAX FR (EPDM).	1/4"
28	C-15/32	Barrier Board: Minimum 1/2" thick water resistant or regular wallboard, with butt joints in the barrier board offset a minimum of 6" from the with the plywood butt joints in the roof deck Insulation (Optional): Any UL Classified polyisocyanurate or phenolic, any thickness. Insulation: Minimum 1/2" thick wood fiber any UL Classified. Membrane: RubberGard MAX FR (EPDM).	1/4"
37	NC	Insulation (Optional): Any UL Classified any thickness, any combination. Insulation: Minimum 1/2" thick wood fiber (any UL Classified) Membrane: RubberGard MAX FR (EPDM).	2"
38	NC	Insulation (Optional): Any combination of the following may be used: Perlite, wood fiber, glass fiber, 3" thick maximum. Insulation: Minimum 1/2" thick wood fiber. Membrane: RubberGard MAX (EPDM), 45 or 60 mil.	1 1/4"
41	NC	Insulation: ISO 95+ GL, any thickness. Membrane: Standard Reinforced RubberGard MAX (EPDM), 45 or 60 mil.	1/2"
42	NC	Insulation (Optional): Any UL Classified polyisocyanurate, phenolic, extruded or expanded polystyrene, any thickness. Insulation: Minimum 1/2" thick wood fiber any UL Classified Membrane: RubberGard MAX (EPDM), 45 or 60 mil.	1 1/4"
44	C-15/32	Insulation (Optional): Any UL Classified, any thickness. Barrier Board: Minimum 1/2" thick water resistant wallboard with butt joints in the barrier board offset a minimum of 6" from the with the plywood butt joints in the roof deck. Insulation (Optional): ISO 95+ GL or ISOGARD GL, any thickness. Membrane: Standard Reinforced RubberGard MAX (EPDM), 45 or 60 mil.	1/4"
45	NC	Barrier Board: Minimum 1/2" thick water resistant or regular wallboard with butt joints in the barrier board offset a minimum of 6" from the with the plywood butt joints in the roof deck Insulation (Optional): Any combination of the following may be used: Perlite, wood fiber, glass fiber, any thickness. Insulation: Minimum 1/2" thick wood fiber. Membrane: RubberGard MAX (EPDM), 45 or 60 mil.	1/4"
47	NC	Insulation (Optional): Any combination of the following may be used with no max thickness: polystyrene (expanded or extruded), perlite, wood fiber, glass fiber, polyisocyanurate, polyurethane, phenolic. Insulation: Minimum 1/2" thick wood fiber (Huebert) or FiberTop B Membrane: RubberGard MAX FR (EPDM), 45 or 60 mil.	2"
48	NC	Insulation: ISOGARD GL ISO any thickness Membrane: RubberGard MAX (EPDM), 45 or 60 mil.	1/4"
59	NC	Insulation (Optional): ISO 95+GL, wood fiber, glass fiber or perlite, any thickness. Membrane: RubberGard MAX FR (EPDM), 45 or 60 mil.	2 1/2"

RubberGard MAX, MAX PT and/or MAX FR EPDM – Attached Membrane – Class A (Continued)

60	NC	<p>Insulation (Optional): Any UL Classified, any thickness.</p> <p>Insulation: – Minimum ½" thick wood fiberboard or minimum ¼" thick DensDeck Roofboard or DensDeck Prime Roofboard or DensDeck DuraGuard Roofboard or minimum 7/16", APA rated plywood or OSB board.</p> <p>Membrane: RubberGard MAX FR (EPDM), 45 or 60 mil.</p>	4"
61	C-15/32	<p>Barrier Board: Minimum ½" thick gypsum board or minimum ¼" thick Georgia-Pacific Gypsum LLC DensDeck Roofboard or DensDeck Prime Roofboard or DensDeck DuraGuard Roofboard.</p> <p>Insulation (Optional): ISO 95+GL, wood fiber, glass fiber or perlite, any thickness.</p> <p>Membrane: RubberGard MAX FR (EPDM), 45 or 60 mil.</p>	2 ½"
62	C-15/32	<p>Barrier Board: Minimum ½" thick gypsum board or minimum ¼" thick Georgia-Pacific Gypsum LLC DensDeck Roofboard or DensDeck Prime Roofboard or DensDeck DuraGuard Roofboard.</p> <p>Insulation (Optional): Any UL Classified, any thickness.</p> <p>Insulation: Minimum ½" thick wood fiberboard or minimum ¼" thick Georgia-Pacific Gypsum LLC DensDeck Roofboard or DensDeck Prime Roofboard or DensDeck DuraGuard Roofboard or minimum 7/16" thick APA rated plywood or OSB board</p> <p>Membrane: RubberGard MAX FR (EPDM), 45 or 60 mil.</p>	4"
63	C-15/32	<p>Slip Sheet: Two or more plies Atlas Roofing Corp. Roofing FR 50, mechanically fastened.</p> <p>Membrane: Any one of the following: a) RubberGard MAX FR, 45 or 60 mil. b) RubberGard MAX, 45, 60 or 75 mil.</p>	½"
64	NC	<p>Insulation (Optional): Any combination of the following may be used: Perlite, wood fiber, glass fiber, 3" thick maximum.</p> <p>Insulation: Minimum ½" thick wood fiber.</p> <p>Membrane: RubberGard MAX (EPDM), 45, 60 or 75 mil.</p>	1 ¼"
65	NC	<p>Insulation Concrete: Deck covered with either of the following insulating concretes (poured in place): Cellular, vermiculite, perlite, gypsum or structural. Optionally, a base concrete deck may be used if all exposed surface joints are grouted.</p> <p>Insulation (Optional): Minimum ½" thick wood fiber any UL Classified.</p> <p>Membrane: RubberGard MAX (EPDM), 45, 60 or 75 mil.</p>	1 ¼"
67	NC	<p>Insulation: ISO 95+ GL, any thickness.</p> <p>Membrane: RubberGard MAX (EPDM), 45, 60 or 75 mil.</p>	½"
68	NC	<p>Insulation (Optional): Any UL Classified polyisocyanurate, phenolic, extruded or expanded polystyrene, any thickness.</p> <p>Insulation: Minimum ½" thick wood fiber any UL Classified</p> <p>Membrane: RubberGard MAX (EPDM), 45, 60 or 75 mil.</p>	1 ¼"
70	C-15/32	<p>Insulation (Optional): Any UL Classified, any thickness.</p> <p>Barrier Board: Minimum ½" thick water resistant wallboard or regular gypsum board with butt joints in the barrier board offset a minimum of 6" from the with the plywood butt joints in the roof deck.</p> <p>Insulation (Optional): Atlas Roofing Corp. ACFoam II, Rmax Operating LLC Multi-Max, ISO 95+ GL, any thickness.</p> <p>Membrane: RubberGard MAX (EPDM), 45, 60 or 75 mil.</p>	¼"
75	C-15/32	<p>Slip Sheet: Two layers GAF VersaShield Underlayment or VersaShield FB-2S, preliminary attachment.</p> <p>Membrane: .045 or .060; RubberGard MAX (½:12); RubberGard MAX FR or 75 mil (1 ½:12); EPDM membranes may be coated with AcryliTop PC-100 at 1 gal/100 ft² and maintain rating.</p>	See Membrane
76	C-15/32	<p>Slip Sheet: Two layers GAF VersaShield Underlayment or VersaShield FB-2S, preliminary attachment.</p> <p>Insulation: ISO 95+ GL (any thickness), preliminary attachment.</p> <p>Membrane: .045 or .060; RubberGard MAX or 75 mil (½:12); RubberGard MAX FR (2:12); EPDM membranes may be coated with AcryliTop PC-100 at 1 gal/100 ft² and maintain rating.</p>	See Membrane

RubberGard MAX, MAX PT and/or MAX FR EPDM – Attached Membrane – Class A (Continued)

77	C-15/32	<p>Slip Sheet: Two layers GAF VersaShield FB-1S, preliminary attachment.</p> <p>Insulation (Optional): ISO 95+ GL (any thickness), preliminary attachment.</p> <p>Membrane:.045 or .060; RubberGard MAX or 75 mil (1/2:12); RubberGard MAX FR (3/4:12); EPDM membranes may be coated with AcryliTop PC-100 at 1 gal/100 ft² and maintain rating.</p>	See Membrane
81	NC	<p>Insulation (Optional): Any UL Classified, any thickness</p> <p>Insulation: Minimum 1/2" thick ISOGARD HD or minimum 1" thick ISOGARD HD Composite Board or 1/2" thick RESISTA or ISOGARD HD</p> <p>Membrane: RubberGard Max, mechanically attached.</p> <p>Surfacing (Optional): After the EPDM is allowed to weather for approximately two weeks, AcryliTop PC-100 at 1 gal/100 ft². Optional: General purpose or silica sand (sieve size of 50 to 100) may be applied into the wet coating at 35-lbs./100-ft².</p>	1/2"
85	NC	<p>Insulation (Optional): Any UL Classified, any thickness</p> <p>Insulation: Minimum 1/2" thick ISOGARD HD or minimum 1" thick ISOGARD HD Composite Board or 1/2" thick RESISTA or ISOGARD CG</p> <p>Membrane: RubberGard Max FR, mechanically attached</p> <p>Surfacing (Optional): After the EPDM is allowed to weather for approximately two weeks, AcryliTop PC-100 at 1 gal/100 ft². Optional: General purpose or silica sand (sieve size of 50 to 100) may be applied into the wet coating at 35-lb./100 ft².</p>	3/4"
86	C-15/32	<p>Insulation (Optional): ISO 95+ GL or ISOGARD GL, any thickness.</p> <p>Insulation: ISOGARD HD Composite Board or RESISTA or ISOGARD CG with butt joints in the insulation offset a minimum of 6" from the with the plywood butt joints in the roof deck.</p> <p>Membrane: RubberGard LS-FR, RubberGard MAX, RubberGard MAX FR and RubberGard Platinum, mechanically attached.</p> <p>Surfacing (Optional): After the EPDM is allowed to weather for approximately two weeks, AcryliTop PC-100 at 1 gal/100 ft². Optional: General purpose or silica sand (sieve size of 50 to 100) may be applied into the wet coating at 35-lb./100 ft².</p>	1/2"

RubberGard MAX, MAX PT and/or MAX FR EPDM – Attached Membrane – Class B

Assembly Number	Deck	Roofing System	Max. Slope
3	C-15/32	<p>Slip Sheet: One layer Atlas Roofing Corp. FR 50.</p> <p>Membrane: Any one of the following: a: RubberGard MAX FR, 45 or 60 mil. b: RubberGard MAX, 45, 60 or 75 mil.</p>	1/2"
6	C-15/32	<p>Base Sheet: One or more plies MB Base Sheet.</p> <p>Insulation: Minimum 1 1/2" thick ISO 95+GL or minimum 1" thick FiberTop B or minimum 1/2-in. thick any UL Classified wood fiber over 1" thick ISO 95+GL or ISOGARD GL</p> <p>Membrane: Standard Reinforced RubberGard (EPDM), 45 or 60 mil, or RubberGard MAX (EPDM), 45, 60 or 75 mil.</p>	1/2"
8	C-15/32	<p>Base Sheet: One or more plies MB Base Sheet.</p> <p>Insulation: Minimum 1 1/2" thick ISO 95+GL or minimum 1" thick FiberTop B or minimum 1/2" thick any UL Classified wood fiber over 1" thick ISO 95+GL or ISOGARD GL</p> <p>Membrane: RubberGard MAX FR (EPDM), 45 or 60 mil.</p>	1"
9	C-15/32	<p>Insulation: Minimum 1" thick FiberTop B or minimum 1/2" thick any UL Classified Wood Fiber over 1 1/2" thick ISO 95+ GL or ISOGARD GL.</p> <p>Membrane: Standard Reinforced RubberGard™ (EPDM), 45 or 60 mil, or RubberGard™ MAX (EPDM), 45, 60 or 75 mil.</p>	1/2"
10	C-15/32	<p>Insulation: Minimum 1" thick FiberTop B or minimum 1/2" thick any UL Classified Wood Fiber over 1 1/2" thick ISO 95+ GL or ISOGARD GL.</p> <p>Membrane: RubberGard MAX FR (EPDM), 45 or 60 mil.</p>	1/4"
11	C-15/32	<p>Insulation: Minimum 1" thick FiberTop B or minimum 1/2" thick any UL Classified Wood Fiber over 1 1/2" thick ISO 95+GL or ISOGARD GL</p> <p>Membrane: RubberGard MAX FR (EPDM), 45 or 60 mil.</p>	1"

RubberGard MAX, MAX PT and/or MAX FR EPDM – Attached Membrane – Class B (Continued)

12	C-15/32	<p>Slip Sheet: One layer GAF VersaShield Underlayment or VersaShield FB-2S, preliminary attachment.</p> <p>Membrane: RubberGard MAX or 75 mil (1/2:12); RubberGard MAX FR (1 1/2:12); EPDM membranes may be coated with AcryliTop PC-100 at 1 gal/100 ft² and maintain rating.</p>	See Membrane
14	C-15/32	<p>Insulation (Optional): ISO 95+ GL or ISOGARD GL, any thickness,</p> <p>Insulation: Minimum 1/2" thick ISOGARD HD or minimum 1" thick ISOGARD HD Composite Board or 1/2" thick RESISTA or ISOGARD CG with butt joints in the insulation offset a minimum of 6" from the plywood butt joints in the roof deck.</p> <p>Membrane: RubberGard LS-FR, RubberGard MAX, RubberGard MAX FR and RubberGard Platinum, mechanically attached.</p> <p>Surfacing (Optional): After the EPDM is allowed to weather for approximately two weeks, AcryliTop PC-100 at 1 gal/100 ft². Optional: General purpose or silica sand (sieve size of 50 to 100) may be applied into the wet coating at 35 lb/100 ft².</p>	1/2"

Fire Retardant RubberGard EPDM – Attached Membrane – Class A

Assembly Number	Deck	Roofing System	Max. Slope
7	NC	<p>Insulation (Optional): Polystyrene, polyisocyanurate, polyurethane, perlite, glass fiber, wood fiber, no max thickness.</p> <p>Insulation: Wood fiber, any UL Classified minimum 1/2" thick.</p> <p>Membrane: Fire Retardant RubberGard (EPDM), 45 or 60 mil.</p>	1 1/2"
10	NC	<p>Insulation: ISO 95+ GL, any thickness.</p> <p>Membrane: Fire Retardant RubberGard (EPDM), 45 or 60 mil.</p>	1"
11	NC	<p>Insulation (Optional): Polyisocyanurate, phenolic, perlite, wood fiber, glass fiber, polyurethane, perlite/polyisocyanurate, no max thickness.</p> <p>Insulation: Wood fiber any UL Classified 1/2" thick minimum.</p> <p>Membrane: Fire Retardant RubberGard (EPDM), 45 or 60 mil.</p>	2"
15	NC	<p>Insulation Concrete: Deck covered with either of the following insulating concretes (poured in place): cellular, vermiculite, perlite, gypsum or structural. Optionally, a base concrete deck may be used if all exposed surface joints are grouted.</p> <p>Insulation (Optional): Wood fiber any UL Classified, 1" max.</p> <p>Membrane: Fire Retardant RubberGard (EPDM), 45 or 60 mil.</p>	1"
20	NC	<p>Insulation (Optional): Any UL Classified, any thickness.</p> <p>Barrier Board: Regular or water resistant wallboard, 1/2 in. nominal.</p> <p>Membrane: Fire Retardant RubberGard (EPDM) (45 or 60 mil).</p> <p>Surfacing: (Optional for Fire Retardant RubberGard. After the EPDM is allowed to weather for approximately two weeks, AcryliTop PC-100 at 1 gal/100-ft.2. Optional: General purpose or silica sand (sieve size of 50 to 100) may be applied into the wet coating at 35-lbs/100-ft.2.</p>	3 1/2"
84	NC	<p>Insulation (Optional): Any UL Classified, any thickness.</p> <p>Insulation: Minimum 1/2-in. thick ISOGARD HD or minimum 1-in. thick ISOGARD HD Composite Board or 1/2-in. thick RESISTA or ISOGARD CG.</p> <p>Membrane: Fire Retardant RubberGard, mechanically attached.</p> <p>Surfacing (Optional): After the EPDM is allowed to weather for approximately two weeks, AcryliTop PC-100 at 1-gal/100-ft.2. Optional: General purpose or silica sand (sieve size of 50 to 100) may be applied into the wet coating at 35-lbs./100-ft.2.</p>	3/4"

RubberGard MAX EPDM – Maintenance and Repair Systems - Attached Membrane – Class A

Assembly Number	Deck	Roofing System	Max. Slope
7	NC	<p>Existing Roof System: Class A, B or C, BUR, cap sheet or gravel surfaced, gravel to be maintained at 400 lb/100 ft².</p> <p>Insulation: Dow Chemical USA STYROFOAM Brand Recovery Board, 1" thick max.</p> <p>Ply Sheet: Type G1 or Type G2.</p> <p>Membrane: RubberGard MAX (EPDM), 45 or 60 mil mechanically fastened.</p>	1"

RubberGard MAX EPDM – Maintenance and Repair Systems - Attached Membrane – Class A (Continued)

8	NC	<p>Existing Roof System: Class A, B or C, cap sheet or gravel surfaced, loose gravel may be removed.</p> <p>Insulation: Dow Chemical USA STYROFOAM Brand Recovery Board, maximum 1" thick.</p> <p>Ply Sheet (Optional): Type G1 or Type G2.</p> <p>Membrane: RubberGard MAX FR, 45 or 60 mil mechanically fastened in accordance with the manufacturer's installation instructions.</p>	1"
14	NC	<p>Existing Roof System: Class A, B or C, cap sheet or gravel surfaced, gravel to be maintained at 400 lb/100 ft².</p> <p>Insulation: Dow Chemical USA STYROFOAM Brand Recovery Board, 1" thick max.</p> <p>Ply Sheet: Type G1 or Type G2.</p> <p>Membrane: RubberGard MAX (EPDM), 45 or 60 mil mechanically fastened in accordance with the manufacturer's installation instructions.</p>	1"

EPDM – Maintenance and Repair Systems - Attached Membrane – Class A

Assembly Number	Deck	Roofing System	Max. Slope
2	C-15/32	<p>Existing Roof System: Any Class A, B or C Build-Up Roof System, to retain rating place.</p> <p>Slip Sheet: One layer VersaShield Underlayment, preliminary attachment.</p> <p>Membrane: .045 or .060; RubberGard LS-FR (½:12); RubberGard MAX or 75 mil (½:12); RubberGard MAX FR (1 ½:12); EPDM membranes may be coated with AcryliTop PC-100 at 1 gal/100 ft² and maintain rating.</p>	See Membrane
8	C-15/32	<p>Existing Roof System: Class A, B or C roofing system, to retain the existing Classification, is covered with:</p> <p>Slip Sheet (Optional): One or more layers GAF VersaShield, Atlas Roofing Corp. FR 10 or FR 50.</p> <p>Insulation (Optional): ISOGARD HD, RESISTA, or ISOGARD CG, ISO 95+ GL any thickness.</p> <p>Membrane: RubberGard MAX, Fire Retardant RubberGard, RubberGard MAX FR or RubberGard LS-FR membranes mechanically fastened.</p> <p>NOTE 1: Maximum incline not to exceed that for which the existing roofing system is currently Classified.</p>	See NOTE 1
11	C-15/32	<p>Existing Roof Systems: Class A, B or C, BUR (smooth surface of cap sheet) to retain existing classification covered with:</p> <p>Insulation: Minimum ½" thick ISOGARD HD or minimum 1" thick ISOGARD HD Composite Board.</p> <p>Membrane: RubberGard LS-FR (¾:12), RubberGard Platinum, RubberGard MAX, (½:12), RubberGard MAX FR (2 ½:12) or EcoWhite (1:12).</p>	See NOTE 1

UL Internal Fire Ratings

The assemblies referenced below can be found on the UL Product IQ website. (<https://productiq.ulprospector.com>) To determine the resistance of a building to internal sources of fire, Underwriters Laboratories has conducted extensive testing and classification of wall, floor/ceiling, and roof/ceiling assemblies. UL classified assemblies are rated according to the time in hours the assembly will contain a fire and still maintain structural integrity. Testing is conducted in accordance with UL Standard 263 (ASTM E-119), which is recognized by all major building codes.

Roof/Ceiling Assemblies are listed in the UL Fire Resistance Directory - Vol. 1 under the prefix "P" and are classified by hourly fire rating according to the type of protection used to contain a fire:

Assembly	Protection Used
P000 – P099	Concealed Grid Suspended Ceiling
P200 – P299	Exposed Grid Suspended Ceiling
P400 – P499	Metal Lathe (Plaster) Ceiling
P500 – P599	Gypsum Board Ceiling
P600 – P699	Miscellaneous Fireproofing
P700 – P799	Spray-Applied Resistive Material
P800 – P899	Spray-Applied Resistive Material
P900 – P999	Unprotected Concrete or Composite Decks

It should be noted that the roof membrane forms only a small part of the total roof/ceiling assembly. For a structure to qualify for a “P” Assembly or Roof Deck Construction, all materials used to construct the assembly (including roof decking, ceiling materials, light fixtures, duct work and structural support members) must be UL classified and installed as described in the appropriate UL Directories.

The insulations listed with each of the following “P” Assemblies are not, in most cases, the only UL accepted insulations for that assembly. Consult the UL Fire Resistance Directory - Vol. 1 for “P” Assembly information and the UL Roofing Materials and Systems Directory for Roof Deck Construction information or call Holcim Technical Services for additional accepted insulations.

UL has indicated on page 8 of the 2008 Fire Resistance Directory - Vol. 1 that "Class A, B or C roof coverings consisting of hot mopped or cold applied bituminous materials or a roof covering material classified under 'Roofing Membranes' (CHCI) may be applied directly to the concrete or wood surface of floor designs being used as roofs without a reduction of fire resistance ratings." They further state on page 8 that "Roof insulation is to be carefully controlled relative to manufacturer, type and thickness as specified. Less than the specified thickness could result in higher temperatures on the roof covering while a greater thickness of insulation could cause earlier structural failure. Classified polystyrene insulation, with a density of 5 pcf or less, may be placed on concrete floors or structural concrete roofs without reducing the assembly rating. When polyisocyanurate insulation is used over concrete in D 900 Series Designs, the unrestrained beam rating shall be increased by a minimum of ½ hour."

Roof Deck Constructions are listed in the UL Roofing Materials and Systems Directory and are rated according to the interior flame spread of the assembly as compared to the flame spread of a typical built-up roof installed over a metal deck (UL 1256). Roof Deck Constructions may also be classified according to wind uplift performance. The fire rating of a UL Roof Deck Construction is similar to the Factory Mutual Class I internal fire (calorimeter) rating, and they are deemed equivalent by the Model Building Code Agencies.

**UL Roof Deck Constructions and “P” Assemblies
Deck Constructions (Tested in accordance to UL 1256)**

UltraPly TPO 96/120 roofing systems are classified for use in the following Deck Construction:

1, 2, 9, 14, 120, 123, 158, 200, 219, 237, 260, 276, 289, 292, 325, 374, 411, 412, 413, 419, 421, 440, 441, 444, 457, and 458. Consult Roof Deck Constructions (TGKX) in the UL Roofing Materials and Systems Directory, a Regional Technical Coordinator, or the Elevate Codes Department for an acceptable insulation for use in these constructions.

“P” Assemblies (Designs)

UltraPly TPO roofing systems are classified for use in the following hourly roof / ceiling designs. Ballasted, adhered or mechanically attached systems with or without optional wood fiber or mineral board insulation for use in Design numbers: P215, P216, P225, P227, P230, P231, P242, P246, P251, P259, P405, P406, P407, P410, P508, P510, P511, P512, P513, P514, P519, P701, P708, P709, P710, P711, P712, P717, P718, P719, P720, P722, P723, P725, P726, P727, P728, P729, P730, P731, P732, P733, P734, P735, P737, P738, P739, P801, P810, P811, P815, P819, P822, P824, P825, P826, P827, P902, P903, P904, P905, P906, P907, P908, P909, P910, P911, P912, P913, P914, P915, P916, P917, P919, P920, P921, P922, P923, P925, P926, P927, P928, P929, P930, P931

Consult Fire Resistance Ratings (BXUV) in the UL Fire Resistance Directory, a Regional Technical Coordinator, or the Elevate Codes Department for an acceptable insulation, thickness, and additional requirements.

NOTE: The accepted insulation must be used in a UL Class A, B or C rated roofing assembly. UL acceptable system (e.g., adhering EPDM to Perlite or Fiberglass) listed for "P" design may not be approved for installation and warranty by Holcim Solutions and Products US, LLC. Contact Holcim Technical Services or a Holcim Regional Technical Coordinator concerning acceptance.

Factory Mutual General Information

Factory Mutual Class 1 Approvals cover a wide range of testing of roofing products, including tests for fire resistance, corrosion resistance, fuel contribution and hail damage, Factory Mutual Approvals are known best for the uplift resistance, 1-60, 1-90, etc. afforded by an FM Approved roofing assembly:

- FM 1-60 assemblies have been tested to withstand 60 psf air pressure applied for a period of one minute as well as one minute at the 30 and 45 psf levels.
- FM 1-90 assemblies have been tested to withstand 90 psf air pressure applied for a period of one minute as well as one minute at the 30, 45, 60 and 75 psf levels.
- Higher uplift ratings are possible based on the deck type and its attachment, fastener density and row spacing where applicable.

When Factory Mutual 1-60 or 1-90 uplift ratings are specified, additional insulation attachment and reduced perimeter and corner batten (in-seam plate or batten for Reinforced Systems) spacing will/may be required. Consult the current edition of Factory Mutual Loss Prevention Data Sheets 1-28 and 1-29 for instructions for determining the required corner and perimeter dimensions and reduced spacing and increased fastener densities.

Ground Roughness Definitions

The descriptions below are based on information in ASCE 7. While information on this subject in the body of that standard is relatively brief, the designer must read the considerable additional information provided in the related commentary section of that document, particularly when the exposure is not obvious.

For Exposure Category B to be used:

- a. The exposing terrain should include urban and suburban areas, wooded areas, or other terrain with numerous closely spaced obstructions having the size of single-family dwellings or larger.
- b. Use of this exposure category should be limited to those areas for which the above terrain prevails in all directions for a distance of at least 2600' (800 m) or 20 times the height of the building or other structure, whichever is greater.
- c. Limited openings in this terrain, such as small parking lots, roads, road intersections, playing fields, underdeveloped lots, and tree clearings can be tolerated. For openings that exceed 600' (180 m) in total length measured radially from the building and 165' [50 m] in width, use surface roughness exposure C.
- d. For buildings whose height is less than or equal to 30' (9.1 m), the prevailing exposure B distance may be reduced to 1500' (460 m).
- e. In cases where the difference between exposures B and C is not obvious, use exposure C.

For Exposure Category C to be used:

NOTE: In cases where the difference between exposure B and C is not obvious, use exposure C.

- A. The exposing terrain should be open with scattered obstructions having heights generally less than 30' (9 m), such as flat, open country and grasslands, and in all cases where exposures B and D do not apply.
- B. This also includes where surface roughness exposure B terrain is interrupted by clearings (parking lots, wide roads, road intersections, playing fields, underdeveloped lots, tree clearings, etc.) of greater than 600' (180 m) in total length measured radially from the building and exceeding 165' (50 m) in width.

For Exposure Category D to be used in determining the design wind pressure, all the following must be met:

NOTE: Some examples of D exposures include inland waterways, the Great Lakes, and coastal areas. See fig. 3.2.2.3 in FM Global LPDA 1-28 for examples of Exposure D requirements.

- A. The terrain upwind of the structure must be flat, unobstructed areas or water surfaces including smooth mud flats, salt flats, and unbroken ice and is present in the upwind direction for a distance greater than approximately 5000' (1500 m) or 20 times the building height, and
- B. The building must be within the greater of 600' (180 m) or 20 times the building or structure height from the terrain (see Fig. 3.2.2.3), even if the terrain between the building and the terrain described in A. above would otherwise be considered Category B or C.

Ballasted Systems

The following information has been extracted from FM Global Property Loss Prevention Data Sheet 1-29. FM Approvals does not approve ballasted systems. If a ballasted system is to be used, select components that are FM Approved for use together as shown in a specific RoofNav assembly. In lieu of fasteners or adhesives used to secure above-deck components, use ballast in accordance with information found in LPDS 1-29, Section 2.2.10.17 to provide wind resistance.

It is not possible to evaluate the uplift resistance of ballasted systems in the same manner as adhered coverings. The criterion for failure for the latter systems is separation of the covering from the insulation, or the insulation from the deck. Ballasted systems fail these criteria by definition.

Uplift forces are not uniform over the entire roof. Properly designed ballasted systems, take advantage of the average uplift force in a given roof area. The membrane distributes the uplift force, allowing the ballast to be effectively used. Extreme winds, however, may cause gravel scour, paver dislodgement, and ballooning of the covering. A parapet at least 3 feet (0.9 m) will help to reduce ballast scour.

General Notations

PLEASE NOTE: Not all FM-rated assemblies that use Elevate roofing products are eligible for the Red Shield, Red Shield Warranty. The Holcim standards, guidelines, and specifications regarding roofing system components and attachment for the warranty desired must be followed.

RoofNav® assemblies are summarized in the following tables; however, an assembly search should be conducted to confirm the attachment rates and requirements set for in the approval number. On all occasions, should a discrepancy occur between this guide and RoofNav, the published information located in the approval at www.roofnav.com should be adhered and utilized.

Additionally, please be aware that the following assemblies typically are in reference to the field of the roof rating and attachment. Please refer to FM Global Loss Prevention Data Sheet 1-28 and 1-29 to determine the requirements for additional fastening requirements in the perimeter and corner.

In all cases, when the project is Factory Mutual insured, please consult the FM agent assigned to the review of the project to ensure compliance.

The assemblies listed in this document may not be suitable for a Red Shield Warranty. Prior to installation, contact a Holcim Technical Representative for approval of assembly for warranty purposes.

It is acceptable to use multiple layers of FM Approved insulation, mechanically secured through all layers, provided all the following are true:

- All layers are the same insulation
- The total insulation thickness is not greater than the maximum FM Approved thickness of the insulation
- The mechanical fastening and wind uplift rating are per the FM Approval of the top layer
- The roof cover/insulation/fastener combination is FM Approved.

Water Based Bonding Adhesive-P (WBBA-P) is the equivalent to Water Based Bonding Adhesive-S (WBBA-S)

Large Wall Opening Enhancement

ASCE 7 should be consulted to determine the appropriate building configuration, enclosed, partially enclosed or open. The building configuration impacts the appropriate design and attachment required for the roofing system. If an existing building is altered, adding large openings, change of use, etc., adjustments may need to be made to accommodate the changes.

The large wall opening enhancement is required when the sum of the various opening areas (w x h) is greater than 10% of the wall area.

Perimeter ½ sheets are required in the hatched area as shown in the diagram below. It is common installation practice to extend the perimeter along this entire building plan dimension to accommodate this rule, but it not required. For warranty purposes Holcim finds it acceptable to utilize battens, plates, and fasteners or Invisiweld attachment methods for this enhancement. (See diagram below.)

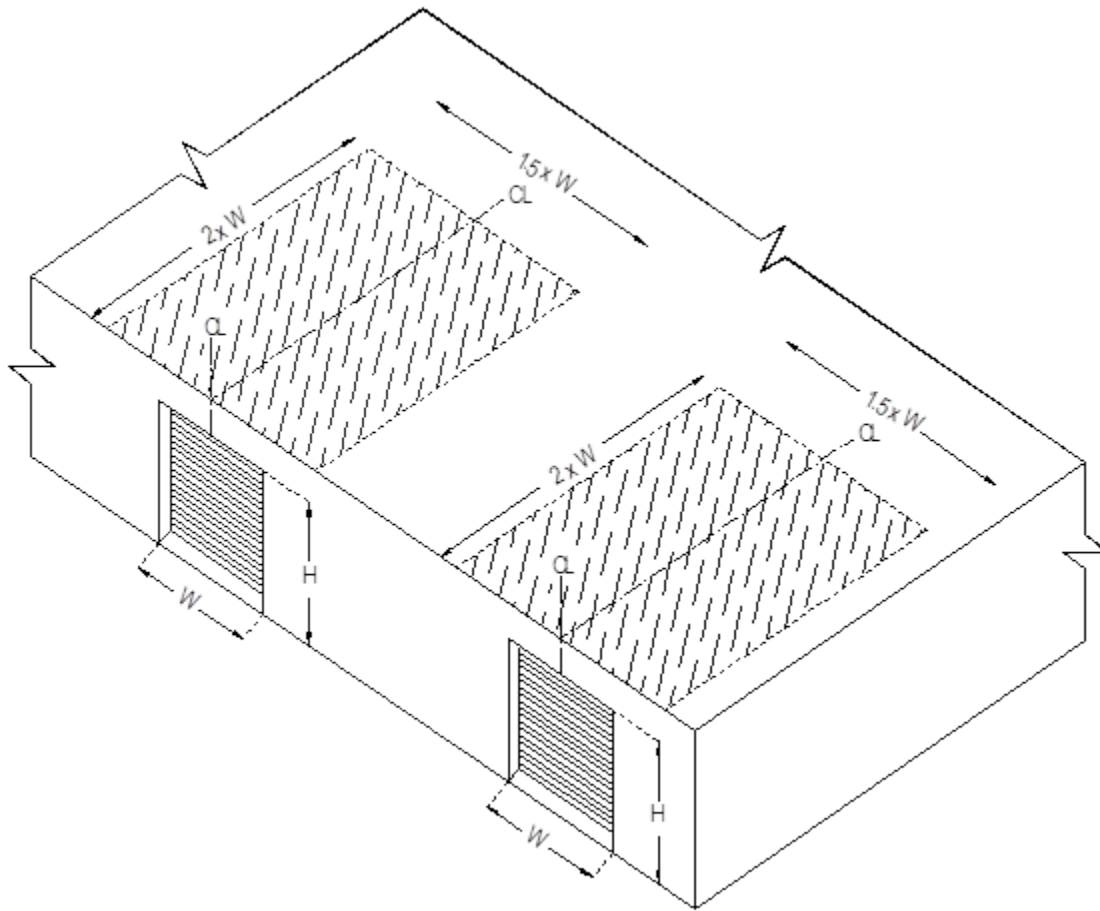

Factory Mutual (FM) Hail Ratings

Use FM RoofNav to find properly rated roof assemblies. The following information has been referenced from the FM Global Property Loss Prevention Data Sheet (LPDS) 1-34. FM recommends using a different hail rated assemblies determined by the projects location. Reference the map provided (Fig. C-1) to determine which rating may be required for your FM insured project. Install the FM Approved roof according to the RoofNav listing and the manufacturer’s instructions. Perimeter flashing while not carrying a hail rating should be installed in accordance with LPDS 1-49, Perimeter Flashing. It is the responsibility of the building owner to validate the project meets the local building code requirements.

FM Hail Ratings

Hail Hazard Area	Roof Assembly Type	FM Approval Rating
Very Severe Hail (VSH)	Poured concrete or concrete paver covered roof ^{1,2}	N/A
	Any FM Approved Roof	VSH
Severe Hail (SH)	Any FM Approved Roof	VSH, SH, FM Class 3, or FM Class 4
	Poured concrete, concrete paver or aggregate (stone) covered roof ^{1,2}	N/A
Moderate Hail (MH)	Any FM Approved Roof	VSH, SH, FM Class 3, or FM Class 4
	Poured concrete, concrete paver or aggregate (stone) covered roof ^{1,2}	

NOTE:

1. Follow Data Sheet 1-29, Roof Deck Securement and Above-Deck Roof Components, for use and restrictions on concrete pavers and aggregate (stone).
2. Concrete pavers meeting ASTM C1491-18, Standard Specification for Concrete Roof Pavers, or equivalent standard outside the US.

Fig. C-1 – Hailstorm Hazard Map for the Contiguous United States

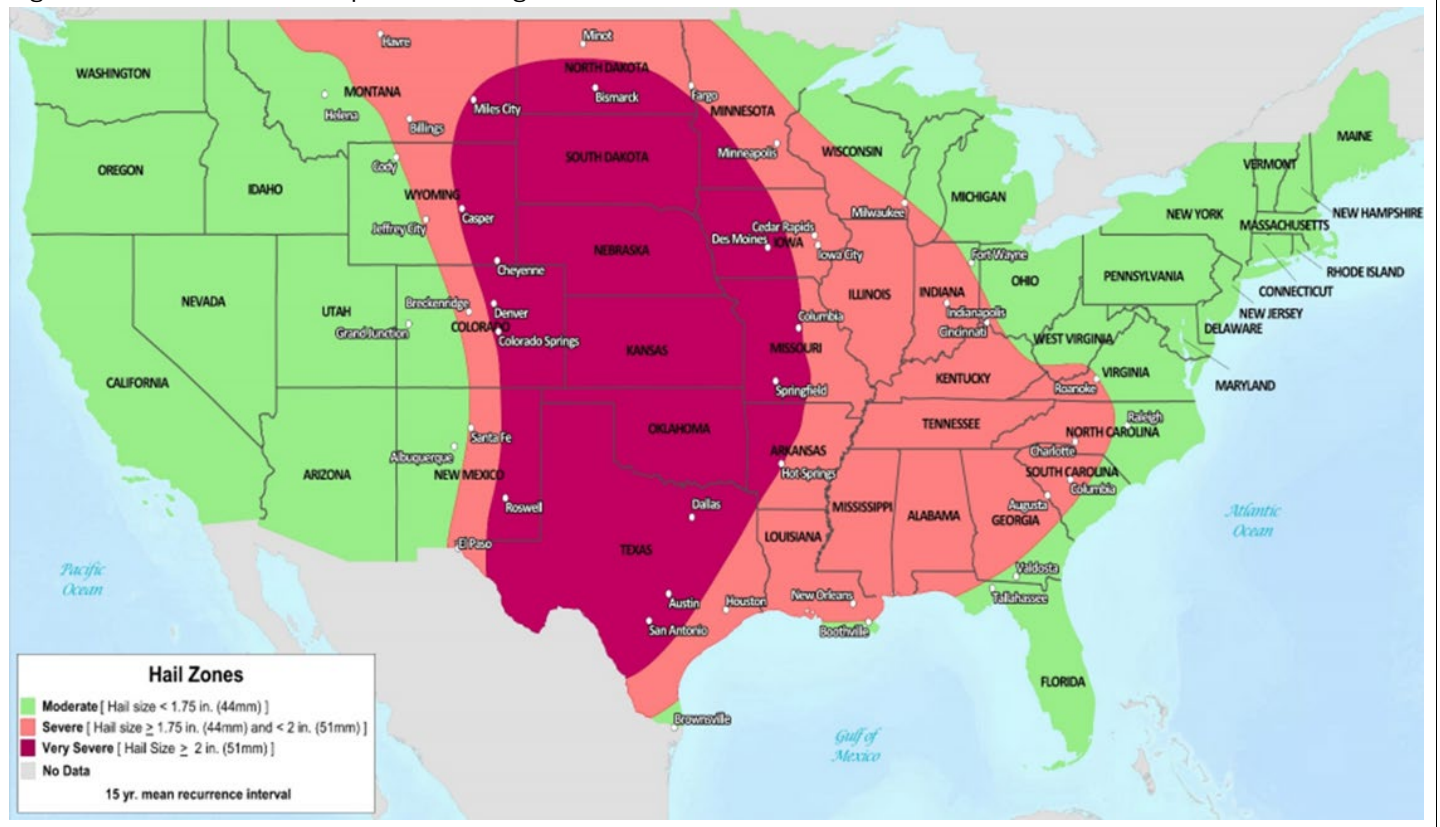

FM – Very Severe Hail

The VHS Listings – Fully Adhered TPO with Adhered DensDeck StormX Prime Cover Board table has been provided at the end of this document. This table lists options that qualify for Very Severe Hail (VSH) ratings from FM Approvals. This table does not represent the full spectrum of assemblies available and FM Approvals and RoofNav.com should be consulted for a full list of qualifying assemblies.

Factory Mutual (FM) – Roof Zone Definition

The following diagrams are referenced from the FM Global Property Lost Prevention Data Sheets 1-28 and 1-29. This outlines how to determine the minimum required roof zone areas based on the building size and relative conditions.

Roof Zone Layout Based on Building Height

NOTE:

If a parapet with a minimum height of 3 ft (0.9 m) is provided around the entire perimeter, Zone 2 values may be used in Zone 3.

For low-slope roofs $\leq 7^\circ$ (1.5 in./ft. slope) and $h \leq 60$ ft (18 m), or $h < 90$ ft (27 m) and $h/w \leq 1.0$, the roof can be divided into four zones as a function of h , where h = the mean roof height.

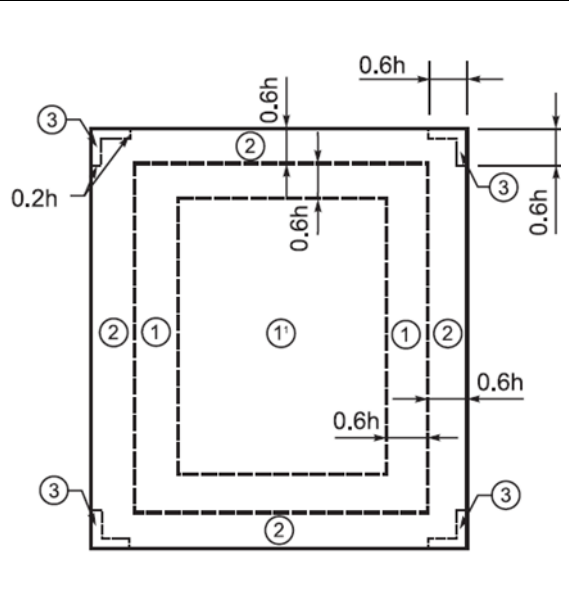

Zone 3 (Corner):
The roof corners, with L-shaped dimension = $0.6h$ by $0.6h$ by $0.2h$.

Zone 2 (Perimeter):
The roof perimeter, inward from the roof edge, with rectangular dimension and width = $0.6h$ from roof edges.

Zone 1 (Field):
The field-of-roof (area inside corners and perimeter corners) up to a distance of $1.2h$ from the roof perimeter.

Zone 1' (Field Prime):
Applies to relatively wide buildings ($> 2.4h$) and covers the remaining roof area inward from Zone 1.

Example: Roof height of 30'
 $.6 \times 30' = 18'$
 $.2 \times 30' = 6'$
Zone 3(Corner): 0.6×30 by 0.6×30 by $0.2 \times 30 = 18'$ by $18'$ by $6'$
Zone 2 (Perimeter): $0.6 \times 30 = 18'$
Zone 1 (Field): $0.6 \times 30 = 18'$
Zone 1' (Field Prime): Covers the remaining roof area inward from Zone 1.

Roof Slopes $\leq 7^\circ$ (1.5 in./ft slope) and $h > 60$ ft (18 m) for $h/w > 1.0$; or $h \geq 90$ ft (27.4 m) for $h/w \leq 1.0$, the roof can be divided into three zones as a function of a , where $a = 10\%$ of the lesser plan dimension, but not less than 3 ft (0.9 m).

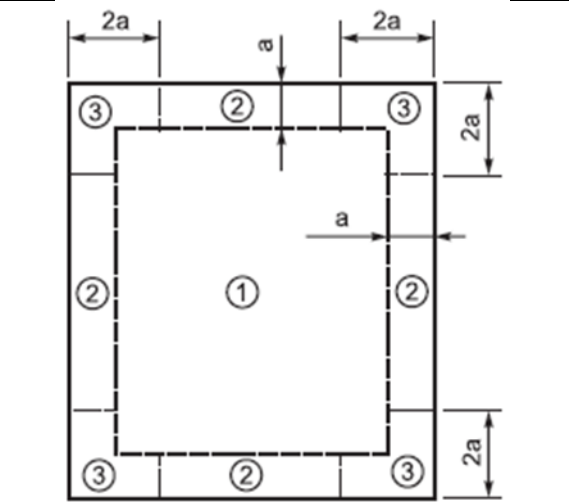

Zone 3(Corner):
The roof corners, with L-shaped dimension = $2a$ by $2a$ by a .

Zone 2 (Perimeter):
The roof perimeter zone width dimension = a width in from roof edges.

Zone 1 (Field):
The field-of-roof (area inside corners and perimeter areas) is the remainder of the roof area.

Example: Roof size and height of 55' x 55' x 65'
 $10\% \text{ of } 55' = 5.5'$
 $a = 5.5'$
Zone 3(Corner): $2 \times 5.5'$ by $2 \times 5.5'$ by $5.5' = 11'$ by $11'$ by $5.5'$
Zone 2 (Perimeter): $5.5'$
Zone 1 (Field): Remainder of roof area

Roof Slopes $> 7^\circ$ ($> 1.5''$)

For roof slopes $> 7^\circ$ ($> 1.5''$), depending on the slope. The width (a) of the various perimeter and corner zones for these steeper sloped roofs equals the lesser of 10% of the building width or $0.4h$, but not less than 4% of the width or 3 ft (0.9 m). See FM Global Property Loss Prevention Data Sheet 1-28 for your specific conditions.

Roof Elevation Changes

Elevation Change of ≥ 10 ft

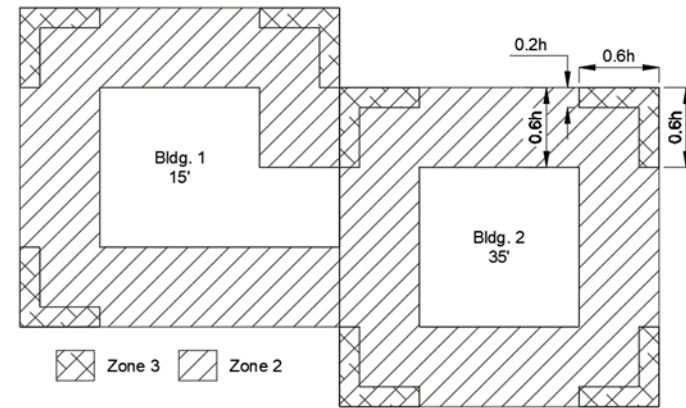

Where the difference in roof elevations between abutting buildings or building sections is greater than or equal to 10 ft (3.0 m), treat abutting areas of the higher building as perimeter and corner areas in accordance with figure shown above.

Elevation Change of < 10 ft

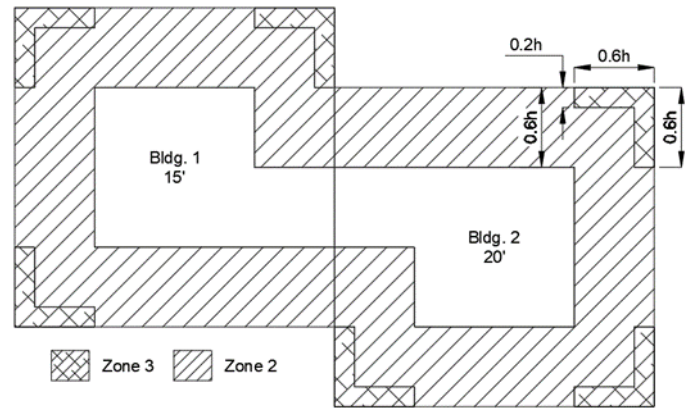

Where the difference in roof elevations between abutting buildings is less than 10 ft (3.0 m), follow guidance in figure shown above. The perimeter and field zones continue from one roof to the other. The buildings must be abutting for this to apply.

NOTE: The buildings do not abut if there is any horizontal separation.

Factory Mutual (FM) – Prescriptive Enhancement Options – Perimeter and Corner

Adhered Membrane – Insulation Enhancements (choose one):

Option 1: Use a system that is rated adequate for Zone 3 in all areas of the roof.

Option 2: Prescriptive enhancements for Zones 2 and 3

Limitations:

- Zone 1 rating in any location does not exceed Class 1-90
- Building is in non-tropical cyclone-prone region and Zone 1 rating does not exceed Class 1-105

For either of the above conditions, increase the securement over the Zone 1 rating as follows:

Mechanically Securement of Insulation Enhancement

Assemblies using insulation fasteners, enhance as follows:

Zone 2: Increase number of fasteners per board by 50% minimum, but at least one fastener per 2 ft²

Zone 3: Install one fastener per 1 ft²

NOTE: Round up to the next whole fasteners if necessary

Adhesive Securement of Insulation Enhancement

Components adhered with adhesives applied in ribbons, spots, etc.:

Zone 2: Install rows not more than 67% of the Zone 1 spacing between rows, or area

Zone 3: Install rows not more than 50% of the Zone 1 spacing between rows, or area

NOTE: Round the bead spacing down to the next whole number. 8.71 in o.c. beads spacing would be rounded down to 8 in o.c.

Mechanically Attached Membrane Securement Enhancement

Mechanically Attached Membrane – Membrane Securement Enhancements – In Seam	
Prescriptively enhance by reducing the distance between rows of roof cover fasteners and stress plates or batten bars from the Zone 1 spacing using the following:	
Zone 2:	Ensure distance between rows is not more than 67% of the FM approved spacing used for Zone 1
Zone 3:	Ensure distance between rows is not more than 50% of the FM approved spacing used for Zone 1
NOTE: For metal decks install all rows of roof cover fasteners perpendicular to the ribs of the roof deck to better distribute the wind load and prevent deck failure.	
Example: A 75 psf rated assembly using a 10' sheet size for Zone 1 (Field), decrease the row spacing for Zone 2 (Perimeter) by no more than 67% and Zone 3 (Corner) by no more than 50% of the field sheet span. (Always round down.)	
Zone 1 (Field): 10' Sheets at 114" o.c. rows of fasteners	
Zone 2 (Perimeter): 114" rows x .67 = 76.38" rows = Max 76" o.c. rows	
Zone 3 (Corner): 114" rows x .5 = 57.5" rows = Max 57" o.c. rows	

InvisiWeld Securement Enhancement

Invisiweld Attached Membrane – Membrane Securement Enhancements	
Prescriptively enhance by reducing the distance between rows of roof cover fasteners and stress plates from the Zone 1 spacing using the following:	
Zone 2:	Decrease spacing between fastener points in one or both directions. Ensure the total tributary area to each fastener is not more than 67% of the FM approved spacing used for Zone 1
Zone 3:	Decrease spacing between fastener points in one or both directions. Ensure the total tributary area to each fastener is not more than 50% of the FM approved spacing used for Zone 1
NOTE: Pre-securement of the insulation may be required. See tested assembly for validation. When rows of fasteners are used install all rows of roof cover fasteners perpendicular to the ribs of the roof deck to better distribute the wind load and prevent deck failure.	
Example: Zone 1: 24" x 24" pattern (6 fasteners per board or a tributary area of 4 sq. ft. per fastener) Zone 2: 16" x 24" pattern (12 fasteners per board or a tributary area of 2.68 sq. ft. per fastener) Due to rib spacing you may need: 12" x 24" pattern (14 per board or tributary area of 2.28 sq. ft. per fastener) Zone 3: 12" x 24" pattern (tributary area of 2 sq. ft. per fastener)	

Base Sheet Attachment Over FM Approved Deck Types

The table below outlines the options for prescriptive enhancement options for base sheet attachment over FM approved deck types. For non-FM approved deck types, like wood, see FM Global Property Loss Prevention Data Sheet 1-29, Section 2.2.10.14.4.

Base Sheet – Mechanically Attached (choose one):	
Option 1:	Use assembly that is rated to meet/exceed Zone 3 across the whole roof.
Option 2:	Use assembly that is rated to meet/exceed each zone.
Option 3:	Reduce the spacing between rows of fasteners by using one intermediate row in Zone 2 and Zone 3.
Option 4:	Reduce the area per fasteners to no more than 67% of the FM approved spacing in Zone 2, and not more than 50% of the FM approved spacing in zone 3.
NOTE:	
<ul style="list-style-type: none"> Install fasteners that engage lightweight insulating concrete (LWIC) no closer than 4 in. (100 mm) on center to avoid cracking the LWIC. When ribbed deck, such as steel deck is used, the fastener spacing within fastener rows must be in even multiples of the deck rib spacing (6 in. [150 mm] for 1-1/2" [38 mm] deep deck) to ensure the fastener engages the top deck flange. To adequately distribute the wind load to the roof deck and its securement and prevent deck buckling and deck securement failure, install fastener rows perpendicular to the deck ribs. 	

Mechanically Attached Membrane – Preliminary Insulation Securement

The table below provides the minimum preliminary insulation fastening rate required for systems using a mechanically attached membrane. Note the rates may differ based on the use or a vapor retarder, different building enclosure classification and building Zone 1 (Field) pressure rating.

Preliminary Insulation Securement for Fastened in the Seam MFSP's				
Vapor Retarder	Building Enclosure Classification	Maximum Required Zone 1 Pressure Rating (P), psf (kPa)	Fastener Requirements for Insulation or Cover Boards up to 4 x 4 ft (1.2 x 1.2 m) board	Fastener Requirements for Insulation or Cover Boards up to 4 x 8 ft (1.2 x 2.4 m) board
No	Enclosed or Partially Enclosed	No Limit	Minimum 2 per board	Minimum 4 per board
Yes	Enclosed	P = 60 (2.9)	Minimum 2 per board	Minimum 4 per board
Yes	Partially Enclosed	P = 60 (2.9)	Minimum 4 per board	Minimum 5 per board
Yes	Enclosed or Partially Enclosed	60 < P ≤ 90 (2.9 < P ≤ 4.3)	Minimum 4 per board	Minimum 5 per board
Yes	Enclosed	90 < P ≤ 300 (4.3 < P ≤ 14.4)	Minimum 4 per board	Minimum 8 per board
Yes	Partially Enclosed	90 < P ≤ 300 (4.3 < P ≤ 14.4)	Minimum 6 per board	Minimum 12 per board
Yes	Enclosed	P > 300 (14.4)	Minimum 6 per board	Minimum 12 per board
Yes	Partially Enclosed	P > 300 (14.4)	Minimum 8 per board	Minimum 16 per board

NOTE: Table 6 does not apply to roof assemblies with air barriers. Where air barriers are used, more stringent guidelines may be required in RoofNav and those must be followed.

ASCE 7 – Basic Wind Speeds for Risk/Occupancy Category

The American Society of Civil Engineers (ASCE) provides basic wind speed maps based on Occupancy/Risk Category of buildings. Refer to the appropriate version of the ASCE for wind maps specific to the building's occupancy category. These maps can be found in the specific editions of the ASCE and can be found at www.atcouncil.org/windspeed. Locations that fall within a special wind region should be reviewed by an engineer to validate the full scope of the project's requirements.

ASCE - American Society of Civil Engineers - Roof Zones – ASCE 7-10 (IBC 2015/2012)

ASCE 7-10 offers basic wind speed maps for occupancy categories I, II, III and IV. In this edition of the ASCE Occupancy Category III and IV are combined on the same map, while categories I and II have their own maps. In this edition three maps are provided based on Occupancy/Risk Category. This version of the ASCE uses a more generalized approach to the areas of the county where most of the county falls within one wind speed and the coastal areas are more defined with contour lines and varying wind speeds.

ASCE 7-10 Perimeter and Corner Definition - Examples

The diagram below is an example only. Each building type and shape may require its own specific layout for perimeters and corners. ASCE 7-10 should be consulted for nonstandard building/roof types and shapes.

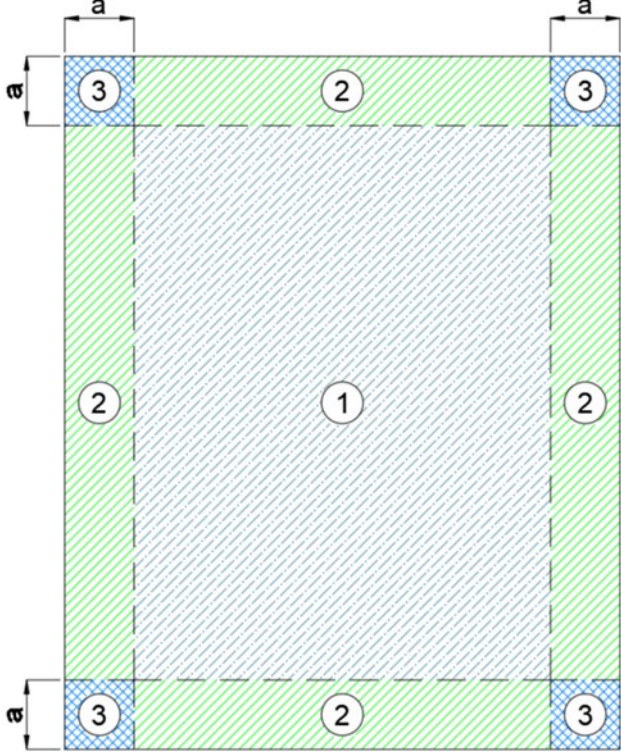
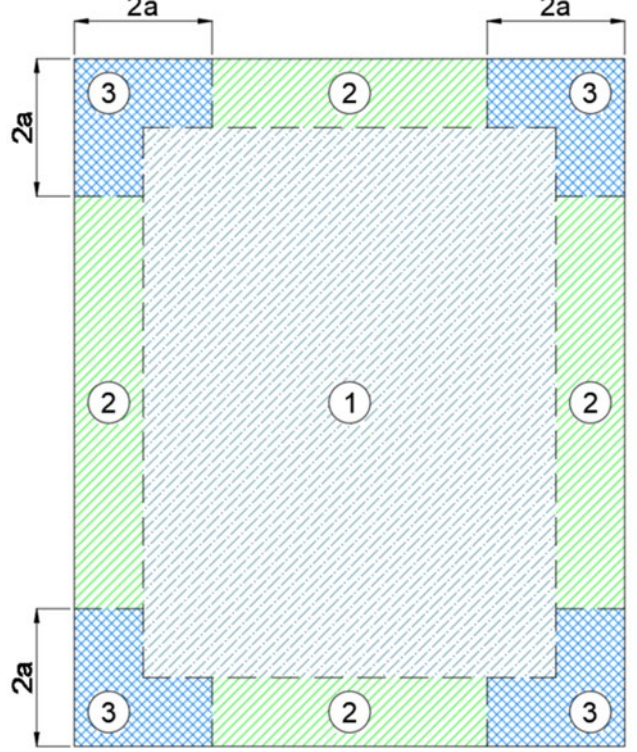
Roof Heights Where $h \leq 60$ ft.	Roof Heights Where $h > 60$ ft.
	
<p>Notation: $a = 10$ percent of least horizontal dimension or $0.4h$, whichever is smaller, but not less than either 4% of least horizontal dimension or 3 ft (0.9 m). $h =$ Eave height shall be used for $\theta \leq 10^\circ$. $\theta =$ Angle of plane of roof from horizontal, in degrees.</p>	<p>Notation: $a = 10$ percent of least horizontal dimension, but not less than 3 ft (0.9 m). $h =$ Eave height shall be used for $\theta \leq 10^\circ$. $\theta =$ Angle of plane of roof from horizontal, in degrees.</p>

ASCE 7-16 (IBC 2018)

ASCE 7-16 offers basic wind speed maps for occupancy categories I, II, III and IV. In this edition of the ASCE all Occupancy/Risk Categories have been defined on their own maps. In this edition four maps are provided based on Occupancy/Risk Category. This version of the ASCE uses more detailed contour lines throughout the map showing more accurate wind speed estimates.

ASCE 7-16 Perimeter and Corner Definition – Examples

Data referenced from ASCE/SEI 7-16 Minimum Design Loads and Associated Criteria for Buildings and Other Structures. All referenced information should be validated against the current document and local relevant building codes. Roof zones may change based on actual building size/layout and roof type. See ASCE documents to validate zones based on building conditions.

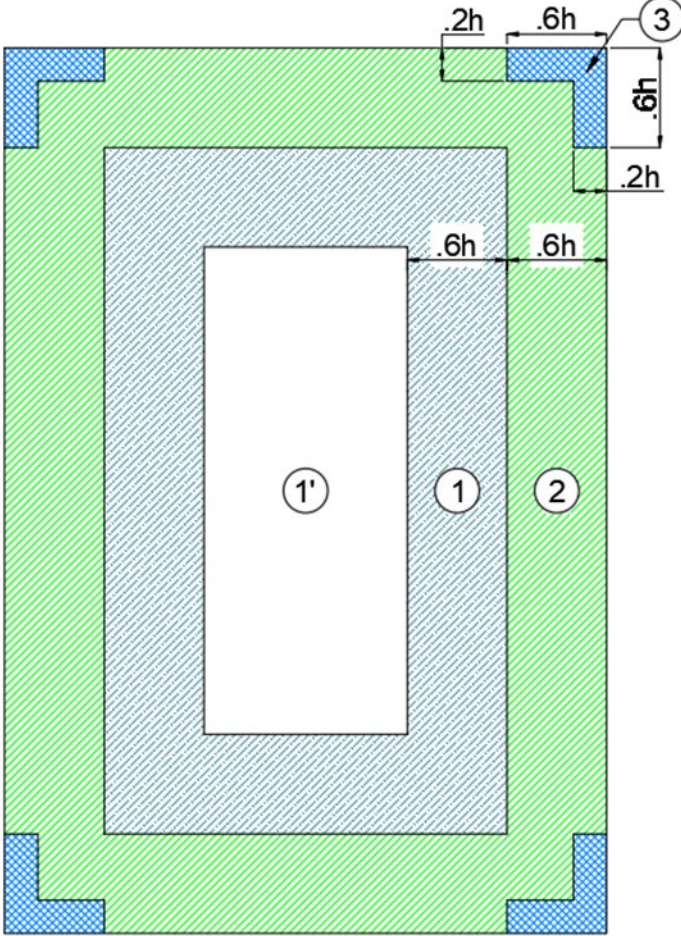
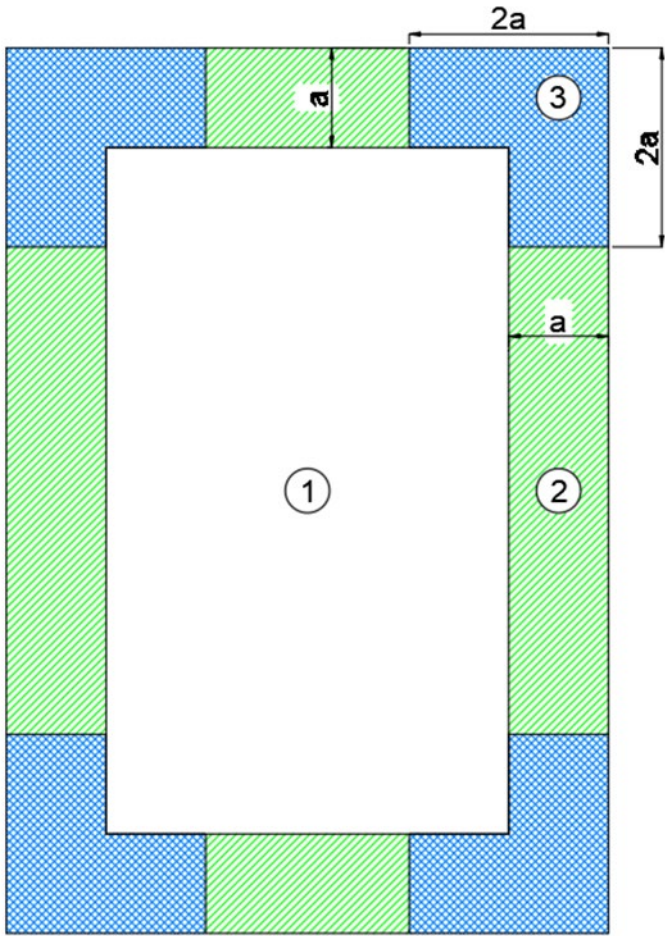
Roof Heights Where $h \leq 60$ ft.	Roof Heights Where $h > 60$ ft.
	
<p>Roof Zone Layout Example for Building Height $\leq 60'$ (Roof Slope $\leq 1.5'' (7^\circ)$) h = Roof Height</p>	<p>Roof Zone Layout Example for Building Heights $> 60'$ (Roof Slope $\leq 1.5'' (7^\circ)$) a = 10% of least horizontal dimension, but not less than 3 ft (0.9 m).</p>
<p>Example: Building Height = 30 ft .6h = 18 ft .2h = 6 ft Zone 3: 18' x 18' x 6'; Zone 2: 18'; Zone 1: 18'; Zone 1': Remainder</p>	<p>Example: Building Dimensions: 80' x 200' Least Horizontal Dimension: 80' $a = 8'$ $2a = 16'$ Zone 3: 16' x 16' x 8'; Zone 2: 8'; Zone 1: Remainder</p>

ASCE 7-16 - Potential Zone Layouts Based on Building Ratio Scenario

The figures below have been referenced from the ASCE 7-16 standard. (Figure C30-1)

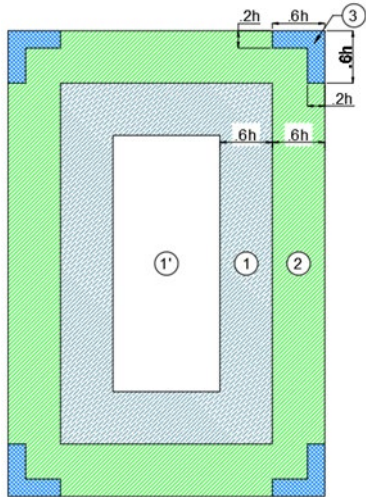

Buildings with least horizontal dimension greater than $2.4h$.

Example: $600' \times 1,000' \times 30' = .2h: 6' \text{ \& \ } .6h: 18'$
Zone 3: $18' \times 18' \times 6'$
Zone 2: 8' wide from roof edge
Zone 1: 8' wide in from Zone 2
Zone 1': Remainder

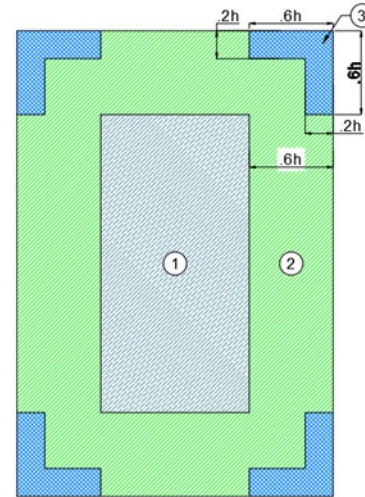

Buildings with least horizontal dimension greater than $1.2h$ but less than $2.4h$.

Example: $50' \times 100' \times 30' = .2h: 6' \text{ \& \ } .6h: 18'$
Zone 3: $18' \times 18' \times 6'$
Zone 2: 18' wide from roof edge
Zone 1: Remainder

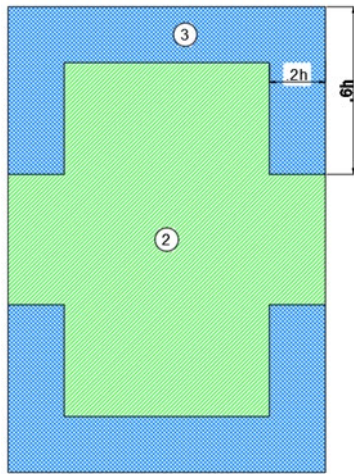

Buildings with least horizontal dimension less than $1.2h$ and largest horizontal dimension greater than $1.2h$.

Example: $30' \times 50' \times 30' = .2h: 6' \text{ \& \ } .6h: 18'$
Zone 3: 6' wide from roof edge, 18' legs
Zone 2: Remainder

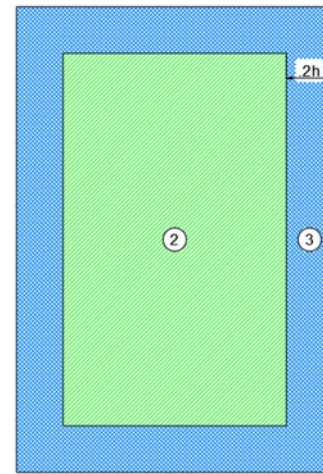

Building with largest horizontal dimension less than $1.2h$.

Example: $20' \times 20' \times 20' = .2h: 4'$
Zone 3: 4' wide from roof edge
Zone 2: Remainder

When the greatest horizontal dimension is less than $0.4h$, the whole roof area is considered Zone 3.

FM Approvals RoofNav Assemblies – Adhered Membrane

RubberGard EPDM LS-FR (Adhered) – Steel Deck – ISO (CF) – Gypsum Cover Board (Attached)

60 PSF

Membrane: RubberGard LS-FR (45 or 60 mil.) or RubberGard LS-FR PT (60 mil.)

Attachment: BA-2004, Single-Ply LVOC, Single-Ply LVOC 1168 or Water Based Bonding Adhesive P

RoofNav #: 100803-0-0	Cover Board	DensDeck		Securock	
		½" min.		½" min.	
Slope: 1"	Attachment	10 Heavy-Duty Fasteners and Plates			
Uplift: 60 psf	Insulation	ISO 95+ GL (F/T)	Resista (F/T)	ISOGARD GL (F/T)	ISOGARD CG (F/T)
		1.5" - 12"	1.5" - 12"	2.3" - 13"	2.3" - 13"
Internal Fire: 1	Attachment	CF			
External Fire: A	Vapor Retarder	Optional: 4-6 mil Poly or V-Force (Primer) over ¼" DensDeck			
Hail: SH	Deck	22 - 16 ga., 72" max span, 33 ksi			

Membrane: RubberGard LS-FR (45 or 60 mil.) or RubberGard LS-FR PT (60 mil.)

Attachment: BA-2004, Single-Ply LVOC, Single-Ply LVOC 1168 or Water Based Bonding Adhesive P

RoofNav #: 100807-0-0	Cover Board	DensDeck		Securock	
		¼" min.		½" min.	
Slope: 1"	Attachment	12 Heavy-Duty Fasteners and Plates			
Uplift: 60 psf	Insulation	ISO 95+ GL (F/T)	Resista (F/T)	ISOGARD GL (F/T)	ISOGARD CG (F/T)
		1.5" - 12"	1.5" - 12"	2.3" - 13"	2.3" - 13"
Internal Fire: 1	Attachment	CF			
External Fire: A	Vapor Retarder	Optional: 4-6 mil Poly or V-Force (Primer) over ¼" DensDeck			
Hail: SH	Deck	22 - 16 ga., 72" max span, 33 ksi			

Membrane: RubberGard LS-FR (45 or 60 mil.) or RubberGard LS-FR PT (60 mil.)

Attachment: BA-2004, Single-Ply LVOC, Single-Ply LVOC 1168 or Water Based Bonding Adhesive P

RoofNav #: 100804-0-0	Cover Board	DensDeck		Securock	
		¼" min.		¼" min.	
Slope: 1"	Attachment	16 Heavy-Duty Fasteners and Plates			
Uplift: 60 psf	Insulation	ISO 95+ GL (F/T)	Resista (F/T)	ISOGARD GL (F/T)	ISOGARD CG (F/T)
		1.5" - 12"	1.5" - 12"	2.3" - 13"	2.3" - 13"
Internal Fire: 1	Attachment	CF			
External Fire: A	Vapor Retarder	Optional: 4-6 mil Poly or V-Force (Primer) over ¼" DensDeck			
Hail: SH	Deck	22 - 16 ga., 72" max span, 33 ksi			

Membrane: RubberGard LS-FR (45 or 60 mil.) or RubberGard LS-FR PT (60 mil.)

Attachment: BA-2004, Single-Ply LVOC, Single-Ply LVOC 1168 or Water Based Bonding Adhesive P

RoofNav #: 422344-0-0	Cover Board	DensDeck		Securock	
		½" min.		½" min.	
Slope: 1"	Attachment	10 Heavy-Duty Fasteners and Plates			
Uplift: 60 psf	Insulation	ISO 95+ GL (F/T)	Resista (F/T)	ISOGARD GL (F/T)	ISOGARD CG (F/T)
		1.5" - 24"	1.5" - 24"	2.3" - 13"	2.3" - 13"
Internal Fire: 1	Attachment	CF			
External Fire: A	Vapor Retarder	V-Force and Primer over ½" DensDeck			
Hail: SH	Deck	22 - 16 ga., 72" max span, 33 ksi			

Membrane: RubberGard LS-FR (45 or 60 mil.) or RubberGard LS-FR PT (60 mil.)

Attachment: BA-2004, Single-Ply LVOC, Single-Ply LVOC 1168 or Water Based Bonding Adhesive P

RoofNav #: 422347-0-0 Slope: 1" Uplift: 60 psf Internal Fire: 1 External Fire: A Hail: SH	Cover Board	DensDeck		Securock	
		¼" min.		¼" min.	
	Attachment	16 Heavy-Duty Fasteners and Plates			
	Insulation	ISO 95+ GL (F/T)	Resista (F/T)	ISOGARD GL (F/T)	ISOGARD CG (F/T)
		1.5" - 24"	1.5" - 24"	2.3" - 13"	2.3" - 13"
	Attachment	CF			
	Vapor Retarder	V-Force and Primer over ½" DensDeck			
Deck	22 - 16 ga., 72" max span, 33 ksi				

Membrane: RubberGard LS-FR (45 or 60 mil.) or RubberGard LS-FR PT (60 mil.)

Attachment: BA-2004, Single-Ply LVOC, Single-Ply LVOC 1168 or Water Based Bonding Adhesive P

RoofNav #: 422352-0-0 Slope: 1" Uplift: 60 psf Internal Fire: 1 External Fire: A Hail: SH	Cover Board	DensDeck		Securock	
		¼" min.		½" min.	
	Attachment	12 Heavy-Duty Fasteners and Plates			
	Insulation	ISO 95+ GL (F/T)	Resista (F/T)	ISOGARD GL (F/T)	ISOGARD CG (F/T)
		1.5" - 24"	1.5" - 24"	2.3" - 13"	2.3" - 13"
	Attachment	CF			
	Vapor Retarder	V-Force and Primer over ½" DensDeck			
Deck	22 - 16 ga., 72" max span, 33 ksi				

Membrane: RubberGard LS-FR (45 or 60 mil.) or RubberGard LS-FR PT (60 mil.)

Attachment: BA-2004

RoofNav #: 399214-0-0 Slope: 1" Uplift: 60 psf Internal Fire: 1 External Fire: A Hail: SH	Cover Board	DensDeck			
		¼" min.			
	Attachment	10 Heavy-Duty Fasteners and Plates			
	Insulation	ISO 95+ GL (F/T)	Resista (F/T)	ISOGARD GL (F/T)	ISOGARD CG (F/T)
		1.5" - 12"	1.5" - 12"	2.3" - 13"	2.3" - 13"
	Attachment	CF			
	Deck	22 - 18 ga., 72" max span, 33 ksi			

75 PSF

Membrane: RubberGard LS-FR (45 or 60 mil.) or RubberGard LS-FR PT (60 mil.)

Attachment: BA-200426

RoofNav #: 399244-0-0 Slope: 1" Uplift: 75 psf Internal Fire: 1 External Fire: A Hail: SH	Cover Board	DensDeck			
		⅝" min.			
	Attachment	6 Heavy-Duty Fasteners and Plates			
	Insulation	ISO 95+ GL (F/T)	Resista (F/T)	ISOGARD GL (F/T)	ISOGARD CG (F/T)
		1.5" - 12"	1.5" - 12"	2.3" - 13"	2.3" - 13"
	Attachment	CF			
	Deck	22 - 18 ga., 72" max span, 33 ksi			

90 PSF

Membrane: RubberGard LS-FR (45 or 60 mil.) or RubberGard LS-FR PT (60 mil.) or EPDM SA

Attachment: BA-2004, Single-Ply LVOC, Single-Ply LVOC 1168 or Water Based Bonding Adhesive P

RoofNav #: 265581-0-0 Slope: 1" Uplift: 90 psf Internal Fire: 1 External Fire: A Hail: SH	Cover Board	DensDeck Prime		Securock	
		¼" min.		½" min.	
	Attachment	12 Heavy-Duty Fasteners and Plates			
	Insulation	ISO 95+ GL (F/T)	Resista (F/T)	ISOGARD GL (F/T)	ISOGARD CG (F/T)
		1.5" - 12"	1.5" - 12"	2.3" - 13"	2.3" - 13"
	Attachment	CF			
	Vapor Retarder	Optional: 4-6 mil Poly or V-Force (Primer) over ¼" DensDeck			
Deck	22 - 16 ga., 72" max span, 33 ksi				

Membrane: RubberGard LS-FR (45 or 60 mil.) or RubberGard LS-FR PT (60 mil.)

Attachment: BA-2004, Single-Ply LVOC, Single-Ply LVOC 1168 or Water Based Bonding Adhesive P

RoofNav #: 100811-0-0 Slope: 1" Uplift: 90 psf Internal Fire: 1 External Fire: A Hail: SH	Cover Board	DensDeck Prime			
		⅝" min.			
	Attachment	8 Heavy-Duty Fasteners and Plates			
	Insulation	ISO 95+ GL (F/T)	Resista (F/T)	ISOGARD GL (F/T)	ISOGARD CG (F/T)
		1.5" - 12"	1.5" - 12"	2.3" - 13"	2.3" - 13"
	Attachment	CF			
	Vapor Retarder	Optional: 4-6 mil Poly or V-Force (Primer) over ¼" DensDeck			
Deck	22 - 16 ga., 72" max span, 33 ksi				

Membrane: RubberGard LS-FR (45 or 60 mil.) or RubberGard LS-FR PT (60 mil.)

Attachment: BA-2004, Single-Ply LVOC, Single-Ply LVOC 1168 or Water Based Bonding Adhesive P

RoofNav #: 422492-0-0 Slope: 1" Uplift: 90 psf Internal Fire: 1 External Fire: A Hail: SH	Cover Board	DensDeck Prime			
		⅝" min.			
	Attachment	8 Heavy-Duty Fasteners and Plates			
	Insulation	ISO 95+ GL (F/T)	Resista (F/T)	ISOGARD GL (F/T)	ISOGARD CG (F/T)
		1.5" - 24"	1.5" - 24"	2.3" - 13"	2.3" - 13"
	Attachment	CF			
	Vapor Retarder	V-Force and Primer over ½" DensDeck			
Deck	22 - 16 ga., 72" max span, 33 ksi				

Membrane: RubberGard LS-FR (45 or 60 mil.) or RubberGard LS-FR PT (60 mil.)

Attachment: BA-2004, Single-Ply LVOC, Single-Ply LVOC 1168 or Water Based Bonding Adhesive P

RoofNav #: 425648-0-0 Slope: 1" Uplift: 90 psf Internal Fire: 1 External Fire: A Hail: SH	Cover Board	DensDeck		Securock	
		¼" min.		½" min.	
	Attachment	12 Heavy-Duty Fasteners and Plates			
	Insulation	ISO 95+ GL (F/T)	Resista (F/T)	ISOGARD GL (F/T)	ISOGARD CG (F/T)
		1.5" - 24"	1.5" - 24"	2.3" - 13"	2.3" - 13"
	Attachment	CF			
	Vapor Retarder	V-Force and Primer over ¼" DensDeck			
Deck	22 - 16 ga., 72" max span, 33 ksi				

Membrane: RubberGard LS-FR (45 or 60 mil.) or RubberGard LS-FR PT (60 mil.)

Attachment: BA-2004, Single-Ply LVOC, Single-Ply LVOC 1168 or Water Based Bonding Adhesive P

RoofNav #: 419730-0-0 Slope: 1" Uplift: 90 psf Internal Fire: 1 External Fire: A Hail: SH	Cover Board	DensDeck		Securock	
		½" min.		½" min.	
	Attachment	16 Heavy-Duty Fasteners and Plates			
	Insulation (Optional)	ISO 95+ GL (F/T)	Resista (F/T)	ISOGARD GL (F/T)	ISOGARD CG (F/T)
		1.5" - 24"	1.5" - 24"	2.3" - 13"	2.3" - 13"
	Attachment	CF			
	Vapor Retarder	V-Force and Primer over ½" DensDeck			
Deck	22 - 16 ga., 72" max span, 33 ksi				

105 PSF

Membrane: RubberGard LS-FR (45 or 60 mil.) or RubberGard LS-FR PT (60 mil.)

Attachment: BA-2004, EPDM Solvent Free, Single-Ply LVOC, Single-Ply LVOC 1168 or Water Based Bonding Adhesive P

RoofNav #: 394347-0-0 Slope: 1" Uplift: 105 psf Internal Fire: 1 External Fire: A Hail: SH	Cover Board	DensDeck Prime			
		¼" min.			
	Attachment	18 Heavy-Duty Fasteners and Plates			
	Insulation	ISO 95+ GL (F/T)	Resista (F/T)	ISOGARD GL (F/T)	ISOGARD CG (F/T)
		1.5" - 12"	1.5" - 12"	2.3" - 13"	2.3" - 13"
	Attachment	CF			
	Vapor Retarder	Optional: 4-6 mil Poly or V-Force (Primer) over ¼" DensDeck			
Deck	22 - 18 ga., Wide Rib, 72" max span, 33 ksi				

Membrane: RubberGard LS-FR (45 or 60 mil.) or RubberGard LS-FR PT (60 mil.)

Attachment: BA-2004, EPDM Solvent Free, Single-Ply LVOC, Single-Ply LVOC 1168 or Water Based Bonding Adhesive P

RoofNav #: 424391-0-0 Slope: 1" Uplift: 105 psf Internal Fire: 1 External Fire: A Hail: SH	Cover Board	DensDeck Prime			
		¼" min.			
	Attachment	18 Heavy-Duty Fasteners and Plates			
	Insulation	ISO 95+ GL (F/T)	Resista (F/T)	ISOGARD GL (F/T)	ISOGARD CG (F/T)
		1.5" - 24"	1.5" - 24"	2.3" - 13"	2.3" - 13"
	Attachment	CF			
	Vapor Retarder	V-Force and Primer over ½" DensDeck			
Deck	22 - 18 ga., Wide Rib, 72" max span, 33 ksi				

120 PSF

Membrane: RubberGard LS-FR (45 or 60 mil.) or RubberGard LS-FR PT (60 mil.)

Attachment: EPDM Solvent Free Bonding Adhesive

RoofNav #: 394347-0-0 Slope: 1" Uplift: 120 psf Internal Fire: 1 External Fire: A Hail: SH	Cover Board	DensDeck Prime		Securock	
		½" min.		½" min.	
	Attachment	24 Heavy-Duty Fasteners and Plates			
	Insulation	ISO 95+ GL (F/T)	Resista (F/T)	ISOGARD GL (F/T)	ISOGARD CG (F/T)
		1.5" - 12"	1.5" - 12"	2.3" - 13"	2.3" - 13"
	Attachment	CF			
	Vapor Retarder	Optional: 4-6 mil Poly or V-Force (Primer) over ¼" DensDeck			
Deck	22 - 18 ga., Wide Rib, 72" max span, 33 ksi				

Membrane: RubberGard LS-FR (45 or 60 mil.) or RubberGard LS-FR PT (60 mil.)

Attachment: EPDM Solvent Free Bonding Adhesive

RoofNav #: 425133-0-0 Slope: 1" Uplift: 120 psf Internal Fire: 1 External Fire: A Hail: SH	Cover Board	DensDeck Prime		Securock	
		½" min.		½" min.	
	Attachment	24 Heavy-Duty Fasteners and Plates			
	Insulation	ISO 95+ GL (F/T)		ISOGARD GL (F/T)	
		1.5" - 24"		2.3" - 13"	
	Attachment	CF			
	Vapor Retarder	V-Force and Primer over ½" DensDeck			
Deck	22 - 18 ga., Wide Rib, 72" max span, 33 ksi				

135 PSF

Membrane: RubberGard LS-FR (45 or 60 mil.) or RubberGard LS-FR PT (60 mil.)

Attachment: BA-2004, EPDM Solvent Free, Single-Ply LVOC or Single-Ply LVOC 1168

RoofNav #: 395778-0-0 Slope: 1" Uplift: 135 psf Internal Fire: 1 External Fire: A Hail: SH	Cover Board	DensDeck Prime			
		1/2" min.			
	Attachment	18 Heavy-Duty Fasteners and Plates			
	Insulation	ISO 95+ GL (F/T)	Resista (F/T)	ISOGARD GL (F/T)	ISOGARD CG (F/T)
		1.5" - 12"	1.5" - 12"	2.3" - 13"	2.3" - 13"
	Attachment	CF			
	Vapor Retarder	Optional: 4-6 mil Poly or V-Force (Primer) over 1/4" DensDeck			
Deck	22 - 18 ga., Wide Rib, 72" max span, 33 ksi				

Membrane: RubberGard LS-FR (45 or 60 mil.) or RubberGard LS-FR PT (60 mil.)

Attachment: BA-2004, EPDM Solvent Free, Single-Ply LVOC or Single-Ply LVOC 1168

RoofNav #: 424410-0-0 Slope: 1" Uplift: 120 psf Internal Fire: 1 External Fire: A Hail: SH	Cover Board	DensDeck Prime			
		1/2" min.			
	Attachment	18 Heavy-Duty Fasteners and Plates			
	Insulation	ISO 95+ GL (F/T)	Resista (F/T)	ISOGARD GL (F/T)	ISOGARD CG (F/T)
		1.5" - 24"	1.5" - 24"	2.3" - 13"	2.3" - 13"
	Attachment	CF			
	Vapor Retarder	Optional: 4-6 mil Poly or V-Force (Primer) over 1/2" DensDeck			
Deck	22 - 18 ga., Wide Rib, 72" max span, 33 ksi				

150 PSF

Membrane: RubberGard LS-FR (45 or 60 mil.) or RubberGard LS-FR PT (60 mil.)

Attachment: BA-2004, EPDM Solvent Free, Single-Ply LVOC or Single-Ply LVOC 1168

RoofNav #: 395779-0-0 Slope: 1" Uplift: 150 psf Internal Fire: 1 External Fire: A Hail: SH	Cover Board	DensDeck Prime			
		1/2" min.			
	Attachment	20 Heavy-Duty Fasteners and Plates			
	Insulation	ISO 95+ GL (F/T)	Resista (F/T)	ISOGARD GL (F/T)	ISOGARD CG (F/T)
		1.5" - 12"	1.5" - 12"	2.3" - 13"	2.3" - 13"
	Attachment	CF			
	Vapor Retarder	Optional: 4-6 mil Poly or V-Force (Primer) over 1/4" DensDeck			
Deck	22 - 18 ga., Wide Rib, 72" max span, 33 ksi				

Membrane: RubberGard LS-FR (45 or 60 mil.) or RubberGard LS-FR PT (60 mil.)

Attachment: BA-2004, Single-Ply LVOC or Single-Ply LVOC 1168

RoofNav #: 200396-0-0 Slope: 1" Uplift: 150 psf Internal Fire: 1 External Fire: A Hail: SH	Cover Board	DensDeck Prime	Securock	
		1/2" min.	1/2" min.	
	Attachment	24 Heavy-Duty Fasteners and Plates		
	Insulation	ISO 95+ GL (F/T)	ISOGARD GL (F/T)	
		1.5" - 12"	2.3" - 13"	
	Attachment	CF		
	Vapor Retarder	Optional: 4-6 mil Poly or V-Force (Primer) over 1/4" DensDeck		
Deck	22 - 18 ga., Wide Rib, 72" max span, 33 ksi			

Membrane: RubberGard LS-FR (45 or 60 mil.) or RubberGard LS-FR PT (60 mil.)

Attachment: BA-2004, EPDM Solvent Free, Single-Ply LVOC or Single-Ply LVOC 1168

RoofNav #: 424412-0-0 Slope: 1" Uplift: 150 psf Internal Fire: 1 External Fire: A Hail: SH	Cover Board	DensDeck Prime			
		1/2" min.			
	Attachment	20 Heavy-Duty Fasteners and Plates			
	Insulation	ISO 95+ GL (F/T)	Resista (F/T)	ISOGARD GL (F/T)	ISOGARD CG (F/T)
		1.5" - 24"	1.5" - 24"	2.3" - 13"	2.3" - 13"
	Attachment	CF			
	Vapor Retarder	V-Force and Primer over 1/2" DensDeck			
Deck	22 - 18 ga., Wide Rib, 72" max span, 33 ksi				

165 PSF

Membrane: RubberGard LS-FR (45 or 60 mil.) or RubberGard LS-FR PT (60 mil.)

Attachment: BA-2004, EPDM Solvent Free, Single-Ply LVOC or Single-Ply LVOC 1168

RoofNav #: 328639-0-0 Slope: 1" Uplift: 165 psf Internal Fire: 1 External Fire: A Hail: SH	Cover Board	DensDeck Prime	Securock	
		1/2" min.		
	Attachment	32 Heavy-Duty Fasteners and Plates		
	Insulation	ISO 95+ GL (F/T)	ISOGARD GL (F/T)	
		1.5" - 12"	2.3" - 13"	
	Attachment	CF		
	Vapor Retarder	Optional: 4-6 mil Poly or V-Force (Primer) over 1/4" DensDeck		
Deck	22 - 18 ga., Wide Rib, 72" max span, 33 ksi			

Membrane: RubberGard LS-FR (45 or 60 mil.) or RubberGard LS-FR PT (60 mil.)

Attachment: BA-2004, EPDM Solvent Free, Single-Ply LVOC or Single-Ply LVOC 1168

RoofNav #: 427085-0-0 Slope: 1" Uplift: 165 psf Internal Fire: 1 External Fire: A Hail: SH	Cover Board	DensDeck Prime	Securock	
		1/2" min.		
	Attachment	32 Heavy-Duty Fasteners and Plates		
	Insulation	ISO 95+ GL (F/T)	ISOGARD GL (F/T)	
		1.5" - 24"	2.3" - 13"	
	Attachment	CF		
	Vapor Retarder	Optional: 4-6 mil Poly or V-Force (Primer) over 1/2" DensDeck		
Deck	22 - 18 ga., Wide Rib, 72" max span, 33 ksi			

180 PSF

Membrane: RubberGard LS-FR (45 or 60 mil.) or RubberGard LS-FR PT (60 mil.)

Attachment: BA-2004

RoofNav #: 384587-0-0 Slope: 1" Uplift: 165 psf Internal Fire: 1 External Fire: A Hail: SH	Cover Board	DensDeck Prime		
		1/2" min.		
	Attachment	32 Heavy-Duty Fasteners and Plates		
	Insulation	ISO 95+ GL (F)	ISOGARD GL (F)	
		1.5" - 12"	2.3" - 13"	
	Attachment	CF		
	Deck	22 - 18 ga., Wide Rib, 72" max span, 80 ksi		

210 PSF

Membrane: RubberGard LS-FR (45 or 60 mil.) or RubberGard LS-FR PT (60 mil.)

Attachment: BA-2004, EPDM Solvent Free, Single-Ply LVOC or Single-Ply LVOC 1168

RoofNav #: 200397-0-0 Slope: 1" Uplift: 210 psf Internal Fire: 1 External Fire: A Hail: SH	Cover Board	DensDeck Prime	Securock
		½" min.	
	Attachment	32 Heavy-Duty Fasteners and Plates	
	Insulation	ISO 95+ GL (F/T)	ISOGARD GL (F/T)
		1.5" - 12"	2.3" - 13"
	Attachment	CF	
	Vapor Retarder	Optional: 4-6 mil Poly or V-Force (Primer) over ¼" DensDeck	
Deck	20 - 18 ga., Wide Rib, 72" max span, 33 ksi 22 ga., Wide Rib, 64" max span, 33 ksi 22 - 18 ga., Wide Rib, 72" max span, 80 ksi		

Membrane: RubberGard LS-FR (45 or 60 mil.) or RubberGard LS-FR PT (60 mil.)

Attachment: BA-2004, Single-Ply LVOC or Single-Ply LVOC 1168

RoofNav #: 200397-0-0 Slope: 1" Uplift: 210 psf Internal Fire: 1 External Fire: A Hail: SH	Cover Board	DensDeck Prime	Securock
		½" min.	
	Attachment	32 Heavy-Duty Fasteners and Plates	
	Insulation	ISO 95+ GL (F/T)	ISOGARD GL (F/T)
		1.5" - 24"	2.3" - 13"
	Attachment	CF	
	Vapor Retarder	V-Force and Primer over ¼" DensDeck	
Deck	20 - 18 ga., Wide Rib, 72" max span, 33 ksi 22 ga., Wide Rib, 64" max span, 33 ksi 22 - 18 ga., Wide Rib, 72" max span, 80 ksi		

255 PSF

Membrane: RubberGard LS-FR (45 or 60 mil.) or RubberGard LS-FR PT (60 mil.)

Attachment: BA-2004, EPDM Solvent Free or Single-Ply LVOC

RoofNav #: 387885-0-0 Slope: 1" Uplift: 255 psf Internal Fire: 1 External Fire: A Hail: SH	Cover Board	DensDeck Prime	
		½" min.	
	Attachment	32 Heavy-Duty Fasteners and Plates	
	Insulation	ISO 95+ GL (F/T)	ISOGARD GL (F/T)
		1.5" - 12"	2.3" - 13"
	Attachment	CF	
	Deck	22 - 18 ga., Wide Rib, 72" max span, 80 ksi	

RubberGard EPDM (Adhered) – Jet Bond Adhesive – Steel Deck – ISO (Attached)

60 PSF

Membrane: LS-FR (45 or 60 mil.), LS-FR PT (60 mil.), Platinum (90 mil.) or Platinum PT (90 mil.)

Attachment: Jet Bond Spray Adhesive

RoofNav #: 464248-0-0 Slope: ½" Uplift: 60 psf Internal Fire: 1 External Fire: A Hail: SH	Insulation	ISO 95+ GL (F)	Resista (F)	ISOGARD GL (F)	ISOGARD CG (F)
		1.5" - 12"	1.5" - 12"	2.3" - 13"	2.3" - 13"
	Attachment	10 Heavy-Duty or All Purpose Fasteners and Plates			
	Vapor Retarder	Optional: 4-6 mil Poly or V-Force (Primer) over ¼" DensDeck			
	Deck	22 - 16 ga., 72" max span, 33 ksi			

75 PSF

Membrane: LS-FR (45 or 60 mil.), LS-FR PT (60 mil.), Platinum (90 mil.) or Platinum PT (90 mil.)

Attachment: Jet Bond Spray Adhesive

RoofNav #: 464795-0-0 Slope: 1/2" Uplift: 75 psf Internal Fire: 1 External Fire: A Hail: SH	Insulation	ISO 95+ GL (F)	Resista (F)	ISOGARD GL (F)	ISOGARD CG (F)
		1.5" - 12"	1.5" - 12"	2.3" - 13"	2.3" - 13"
	Attachment	12 Heavy-Duty or All Purpose Fasteners and Plates			
	Deck	22 - 16 ga., 72" max span, 33 ksi			

Membrane: LS-FR (45 or 60 mil.), LS-FR PT (60 mil.), Platinum (90 mil.) or Platinum PT (90 mil.)

Attachment: Jet Bond Spray Adhesive

RoofNav #: 465181-0-0 Slope: 1/2" Uplift: 75 psf Internal Fire: 1 External Fire: A Hail: SH	Insulation	ISO 95+ GL (F)	Resista (F)	ISOGARD GL (F)	ISOGARD CG (F)
		2" - 12"	2" - 12"	2.3" - 13"	2.3" - 13"
	Attachment	8 All Purpose Fasteners and Plates			
	Vapor Retarder	V-Force and Primer over 1/4" DensDeck			
Deck	22 - 16 ga., 72" max span, 33 ksi				

Membrane: LS-FR (45 or 60 mil.), LS-FR PT (60 mil.), Platinum (90 mil.) or Platinum PT (90 mil.)

Attachment: Jet Bond Spray Adhesive

RoofNav #: 465182-0-0 Slope: 1/2" Uplift: 75 psf Internal Fire: 1 External Fire: A Hail: SH	Insulation	ISO 95+ GL (F)	Resista (F)	ISOGARD GL (F)	ISOGARD CG (F)
		2" - 12"	2" - 12"	2.3" - 13"	2.3" - 13"
	Attachment	8 All Purpose Fasteners and Plates			
	Thermal Barrier	Optional: 1/4" DensDeck			
Deck	22 - 16 ga., 72" max span, 33 ksi				

90 PSF

Membrane: LS-FR (45 or 60 mil.), LS-FR PT (60 mil.), Platinum (90 mil.) or Platinum PT (90 mil.)

Attachment: Jet Bond Spray Adhesive

RoofNav #: 464249-0-0 Slope: 1/2" Uplift: 90 psf Internal Fire: 1 External Fire: A Hail: SH	Insulation	ISO 95+ GL (F)	Resista (F)	ISOGARD GL (F)	ISOGARD CG (F)
		2" - 12"	2" - 12"	2.3" - 13"	2.3" - 13"
	Attachment	10 Heavy-Duty or All Purpose Fasteners and Plates			
	Vapor Retarder	Optional: 4-6 mil Poly or V-Force (Primer) over 1/4" DensDeck			
Deck	22 - 16 ga., 72" max span, 33 ksi				

Membrane: LS-FR (45 or 60 mil.), LS-FR PT (60 mil.), Platinum (90 mil.) or Platinum PT (90 mil.)

Attachment: Jet Bond Spray Adhesive

RoofNav #: 464830-0-0 Slope: 1/2" Uplift: 90 psf Internal Fire: 1 External Fire: A Hail: SH	Insulation	ISO 95+ GL (F)	Resista (F)	ISOGARD GL (F)	ISOGARD CG (F)
		1.25" - 12"	1.25" - 12"	2.3" - 13"	2.3" - 13"
	Attachment	12 Heavy-Duty or All Purpose Fasteners and Plates			
	Vapor Retarder	Optional: 4-6 mil Poly or V-Force (Primer) over 1/4" DensDeck			
Deck	22 - 16 ga., 72" max span, 33 ksi				

Membrane: LS-FR (45 or 60 mil.), LS-FR PT (60 mil.), Platinum (90 mil.) or Platinum PT (90 mil.)

Attachment: Jet Bond Spray Adhesive

RoofNav #: 465148-0-0 Slope: 1/2" Uplift: 90 psf Internal Fire: 1 External Fire: A Hail: SH	Insulation	ISO 95+ GL (F)	Resista (F)	ISOGARD GL (F)	ISOGARD CG (F)
		2.2" - 12"	2.2" - 12"	2.3" - 13"	2.3" - 13"
	Attachment	8 Heavy-Duty or All Purpose Fasteners and Plates			
	Thermal Barrier	Optional: 1/4" DensDeck/DensDeck Prime; 3/8" Securock; 2" - 6" TopRock DD; 1" - 5" Roxul			
	Vapor Retarder	Optional: 4-6 mil Poly			
Deck	22 - 16 ga., 72" max span, 33 ksi				

105 PSF

Membrane: LS-FR (45 or 60 mil.), LS-FR PT (60 mil.), Platinum (90 mil.) or Platinum PT (90 mil.)

Attachment: Jet Bond Spray Adhesive

RoofNav #: 464483-0-0 Slope: 1/2" Uplift: 105 psf Internal Fire: 1 External Fire: A Hail: SH	Insulation	ISO 95+ GL	ISOGARD GL
		1.5" - 12"	2.3" - 13"
	Attachment	20 Heavy-Duty or All Purpose Fasteners and Plates	
	Vapor Retarder	Optional: 4-6 mil Poly or V-Force (Primer) over 1/4" DensDeck	
Deck	22 - 16 ga., 72" max span, 33 ksi		

120 PSF

Membrane: LS-FR (45 or 60 mil.), LS-FR PT (60 mil.), Platinum (90 mil.) or Platinum PT (90 mil.)

Attachment: Jet Bond Spray Adhesive

RoofNav #: 464624-0-0 Slope: 1/2" Uplift: 120 psf Internal Fire: 1 External Fire: A Hail: SH	Insulation	ISO 95+ GL	ISOGARD GL
		1.5" - 12"	2.3" - 13"
	Attachment	19 Heavy-Duty or All Purpose Fasteners and Plates	
	Vapor Retarder	Optional: 4-6 mil Poly or V-Force (Primer) over 1/4" DensDeck	
Deck	22 - 18 ga., Wide Rib, 72" max span, 33 ksi		

135 PSF

Membrane: LS-FR (45 or 60 mil.), LS-FR PT (60 mil.), Platinum (90 mil.) or Platinum PT (90 mil.)

Attachment: Jet Bond Spray Adhesive

RoofNav #: 464630-0-0 Slope: 1/2" Uplift: 135 psf Internal Fire: 1 External Fire: A Hail: SH	Insulation	ISO 95+ GL	ISOGARD GL
		2" - 12"	2.3" - 13"
	Attachment	16 Heavy-Duty or All Purpose Fasteners and Plates	
	Vapor Retarder	Optional: 4-6 mil Poly or V-Force (Primer) over 1/4" DensDeck	
Deck	22 - 18 ga., Wide Rib, 72" max span, 33 ksi		

165 PSF

Membrane: LS-FR (45 or 60 mil.), LS-FR PT (60 mil.), Platinum (90 mil.) or Platinum PT (90 mil.)

Attachment: Jet Bond Spray Adhesive

RoofNav #: 464562-0-0 Slope: 1/2" Uplift: 165 psf Internal Fire: 1 External Fire: A Hail: SH	Insulation	ISO 95+ GL	ISOGARD GL
		1.5" - 12"	2.3" - 13"
	Attachment	24 Heavy-Duty or All Purpose Fasteners and Plates	
	Vapor Retarder	Optional: 4-6 mil Poly or V-Force (Primer) over 1/4" DensDeck	
Deck	22 - 18 ga., Wide Rib, 72" max span, 33 ksi		

Membrane: LS-FR (45 or 60 mil.), LS-FR PT (60 mil.), Platinum (90 mil.) or Platinum PT (90 mil.)

Attachment: Jet Bond Spray Adhesive

RoofNav #: 464568-0-0 Slope: 1/2" Uplift: 165 psf Internal Fire: 1 External Fire: A Hail: SH	Insulation	ISO 95+ GL	ISOGARD GL
		2" - 12"	2.3" - 13"
	Attachment	20 Heavy-Duty or All Purpose Fasteners and Plates	
	Vapor Retarder	Optional: 4-6 mil Poly or V-Force (Primer) over 1/4" DensDeck	
Deck	22 - 18 ga., Wide Rib, 72" max span, 33 ksi		

225 PSF

Membrane: LS-FR (45 or 60 mil.), LS-FR PT (60 mil.), Platinum (90 mil.) or Platinum PT (90 mil.)

Attachment: Jet Bond Spray Adhesive

RoofNav #: 464489-0-0 Slope: 1/2" Uplift: 225 psf Internal Fire: 1 External Fire: A Hail: SH	Insulation	ISO 95+ GL	ISOGARD GL
		2" - 12"	2.3" - 13"
	Attachment	32 Heavy-Duty or All Purpose Fasteners and Plates	
	Vapor Retarder	Optional: 4-6 mil Poly or V-Force (Primer) over 1/4" DensDeck	
	Deck	18 ga., Wide Rib, 72" max span, 33 ksi; 20 ga., Wide Rib, 69" max span, 33 ksi; 22 ga., Wide Rib, 62" max span, 33 ksi; 22 - 18 ga., Wide Rib, 72" max span, 80 ksi	

300 PSF

Membrane: LS-FR (45 or 60 mil.), LS-FR PT (60 mil.), Platinum (90 mil.) or Platinum PT (90 mil.)

Attachment: Jet Bond Spray Adhesive

RoofNav #: 464530-0-0 Slope: 1/2" Uplift: 300 psf Internal Fire: 1 External Fire: A Hail: SH	Insulation	ISO 95+ GL
		2" - 12"
	Attachment	32 Heavy-Duty or All Purpose Fasteners and Plates
	Vapor Retarder	Optional: 4-6 mil Poly or V-Force (Primer) over 1/4" DensDeck
	Deck	22 - 18 ga., Wide Rib, 72" max span, 80 ksi

RubberGard EPDM (Adhered) – Jet Bond Adhesive – Steel Deck – ISO (Attached) – ISO (Adhered)

60 PSF

Membrane: LS-FR (45 or 60 mil.), LS-FR PT (60 mil.), Platinum (90 mil.) or Platinum PT (90 mil.)

Attachment: Jet Bond Spray Adhesive

RoofNav #: 464603-0-0 Slope: 1/2" Uplift: 60 psf Internal Fire: 1 External Fire: A Hail: SH	Insulation	ISO 95+ GL (F)	Resista (F)	ISOGARD GL (F)	ISOGARD CG (F)
		1.5" - 8"	1.5" - 8"	2.3" - 13"	2.3" - 13"
	Attachment	I.S.O. Spray R, Twin Pack, I.S.O. Stick or Twin Jet			
		12" o.c. bead spacing			
	Insulation	ISO 95+ GL (F/T)	Resista (F/T)	ISOGARD GL (F/T)	ISOGARD CG (F/T)
		1.5" - 4"	1.5" - 4"	2.3" - 13"	2.3" - 13"
	Attachment	12 Heavy-Duty or All Purpose Fasteners and Plates			
	Vapor Retarder	Optional: 4-6 mil Poly or V-Force (Primer) over 1/4" DensDeck			
	Deck	22 - 16 ga., 72" max span, 33 ksi			

90 PSF

Membrane: LS-FR (45 or 60 mil.), LS-FR PT (60 mil.), Platinum (90 mil.) or Platinum PT (90 mil.)

Attachment: Jet Bond Spray Adhesive

RoofNav #: 465140-0-0 Slope: 1/2" Uplift: 90 psf Internal Fire: 1 External Fire: A Hail: SH	Insulation	ISO 95+ GL (F)	Resista (F)	ISOGARD GL (F)	ISOGARD CG (F)
		1/2" - 9.8"	1/2" - 9.8"	2.3" - 13"	2.3" - 13"
	Attachment	I.S.O. Spray R, Twin Pack, I.S.O. Stick or Twin Jet			
		12" o.c. bead spacing			
	Insulation	ISO 95+ GL (F)	Resista (F)	ISOGARD GL (F)	ISOGARD CG (F)
		2" - 12"	2" - 12"	2.3" - 13"	2.3" - 13"
	Attachment	8 Heavy-Duty or All Purpose Fasteners and Plates			
	Vapor Retarder	V-Force and Primer over 1/4" DensDeck/DenDeck Prime or 3/8" Securock			
	Deck	22 - 16 ga., 72" max span, 33 ksi			

Membrane: LS-FR (45 or 60 mil.), LS-FR PT (60 mil.), Platinum (90 mil.) or Platinum PT (90 mil.)

Attachment: Jet Bond Spray Adhesive

RoofNav #: 464743-0-0 Slope: 1/2" Uplift: 90 psf Internal Fire: 1 External Fire: A Hail: SH	Insulation	ISO 95+ GL (F)	Resista (F)	ISOGARD GL (F)	ISOGARD CG (F)
		1.5" - 4"	1.5" - 4"	2.3" - 13"	2.3" - 13"
	Attachment	Twin Pack, I.S.O. Stick or Twin Jet			
		12" o.c. bead spacing			
	Insulation	ISO 95+ GL (F/T)	Resista (F/T)	ISOGARD GL (F/T)	ISOGARD CG (F/T)
		2.25" - 12"	2.25" - 12"	2.3" - 13"	2.3" - 13"
	Attachment	8 Heavy-Duty or All Purpose Fasteners and Plates			
	Vapor Retarder	Optional: 4-6 mil Poly or V-Force (Primer) over 1/4" DensDeck			
Deck	22 - 16 ga., 72" max span, 33 ksi				

Membrane: LS-FR (45 or 60 mil.), RubberGard LS-FR PT (60 mil.), Platinum (90 mil.) or Platinum PT (90 mil.)

Attachment: Jet Bond Spray Adhesive

RoofNav #: 465149-0-0 Slope: 1/2" Uplift: 90 psf Internal Fire: 1 External Fire: A Hail: SH	Insulation	ISO 95+ GL (F)	Resista (F)	ISOGARD GL (F)	ISOGARD CG (F)
		1/2" - 9.8"	1/2" - 9.8"	2.3" - 13"	2.3" - 13"
	Attachment	Twin Pack, I.S.O. Stick or Twin Jet			
		12" o.c. bead spacing			
	Insulation	ISO 95+ GL (F/T)	Resista (F/T)	ISOGARD GL (F/T)	ISOGARD CG (F/T)
		2.2" - 4"	2.2" - 4"	2.3" - 13"	2.3" - 13"
	Attachment	8 Heavy-Duty or All Purpose Fasteners and Plates			
	Vapor Retarder	Optional: 1/4" DensDeck/DensDeck Prime; 3/8" Securock; 2" - 6.3" TopRock DD; 1" - 5" Roxul			
Deck	22 - 16 ga., 72" max span, 33 ksi				

150 PSF

Membrane: LS-FR (45 or 60 mil.), LS-FR PT (60 mil.), Platinum (90 mil.) or Platinum PT (90 mil.)

Attachment: Jet Bond Spray Adhesive

RoofNav #: 464556-0-0 Slope: 1/2" Uplift: 150 psf Internal Fire: 1 External Fire: A Hail: SH	Insulation	ISO 95+ GL (F)	Resista (F)	ISOGARD GL (F)	ISOGARD CG (F)
		1.5" - 8"	1.5" - 8"	2.3" - 13"	2.3" - 13"
	Attachment	I.S.O. Twin Pack			
		12" o.c. bead spacing			
	Insulation	ISO 95+ GL (F/T)	Resista (F/T)	ISOGARD GL (F/T)	ISOGARD CG (F/T)
		1.5" - 4"	1.5" - 4"	2.3" - 13"	2.3" - 13"
	Attachment	20 Heavy-Duty or All Purpose Fasteners and Plates			
	Vapor Retarder	Optional: 4-6 mil Poly or V-Force (Primer) over 1/4" DensDeck			
Deck	22 - 16 ga., Wide Rib, 72" max span, 33 ksi				

165 PSF

Membrane: LS-FR (45 or 60 mil.), LS-FR PT (60 mil.), Platinum (90 mil.) or Platinum PT (90 mil.)

Attachment: Jet Bond Spray Adhesive

RoofNav #: 464847-0-0 Slope: 1/2" Uplift: 165 psf Internal Fire: 1 External Fire: A Hail: SH	Insulation	ISO 95+ GL (F)	ISOGARD GL (F)
		1" - 4"	2.3" - 13"
	Attachment	I.S.O. Spray R, Twin Pack, I.S.O. Stick or Twin Jet	
		4" o.c. bead spacing	
	Insulation	ISO 95+ GL (F/T)	ISOGARD GL (F/T)
		2" - 4"	2.3" - 13"
	Attachment	32 Heavy-Duty or All Purpose Fasteners and Plates	
	Vapor Retarder	Optional: 4-6 mil Poly or V-Force (Primer) over 1/4" DensDeck	
Deck	22 - 18 ga., Wide Rib, 72" max span, 33 ksi		

225 PSF

Membrane: LS-FR (45 or 60 mil.), LS-FR PT (60 mil.), Platinum (90 mil.) or Platinum PT (90 mil.)

Attachment: Jet Bond Spray Adhesive

RoofNav #: 464807-0-0 Slope: 1/2" Uplift: 225 psf Internal Fire: 1 External Fire: A Hail: SH	Insulation	ISO 95+ GL (F)	ISOGARD GL (F)
		1" - 4"	2.3" - 13"
	Attachment	Twin Pack, I.S.O. Stick or Twin Jet	
		4" o.c. bead spacing	
	Insulation	ISO 95+ GL (F/T)	ISOGARD GL (F/T)
		2" - 4"	2.3" - 13"
	Attachment	32 Heavy-Duty or All Purpose Fasteners and Plates	
Vapor Retarder	Optional: 4-6 mil Poly or V-Force (Primer) over 1/4" DensDeck		
Deck	18 ga., Wide Rib, 72" max span, 33 ksi; 20 ga., Wide Rib, 69" max span, 33 ksi; 22 ga., Wide Rib, 62" max span, 33 ksi; 22 - 18 ga., Wide Rib, 72" max span, 80 ksi		

255 PSF

Membrane: LS-FR (45 or 60 mil.), LS-FR PT (60 mil.), Platinum (90 mil.) or Platinum PT (90 mil.)

Attachment: Jet Bond Spray Adhesive

RoofNav #: 464815-0-0 Slope: 1/2" Uplift: 255 psf Internal Fire: 1 External Fire: A Hail: SH	Insulation	ISO 95+ GL (F)	ISOGARD GL (F)
		1" - 4"	2.3" - 13"
	Attachment	Twin Pack, I.S.O. Stick or Twin Jet	
		4" o.c. bead spacing	
	Insulation	ISO 95+ GL (F/T)	ISOGARD GL (F/T)
		2" - 4"	2.3" - 13"
	Attachment	32 Heavy-Duty or All Purpose Fasteners and Plates	
Vapor Retarder	Optional: 4-6 mil Poly or V-Force (Primer) over 1/4" DensDeck		
Deck	22 - 18 ga., Wide Rib, 72" max span, 80 ksi		

RubberGard EPDM (Adhered) – Steel Deck – ISO (CF) – ISOGARD HD (Attached)

90 PSF

Membrane: LS-FR (45 or 60 mil.), LS-FR PT (60 mil.), Platinum (90 mil.) or Platinum PT (90 mil.)

Attachment: Jet Bond Spray Adhesive, BA-2004, EPDM SFBA, SP LVOC BA, SP LVOC BA-1168

RoofNav #: 285091-0-0 Slope: 1/4" Uplift: 90 psf Internal Fire: 1 External Fire: A Hail: SH	Cover Board	ISOGARD HD			
		1/2"			
	Attachment	12 Heavy-Duty or All Purpose Fasteners and Plates			
	Insulation	ISO 95+ GL (F/T)	Resista (F/T)	ISOGARD GL (F/T)	ISOGARD CG (F/T)
		1.5" - 12"	1.5" - 12"	2.3" - 13"	2.3" - 13"
	Attachment	Common Fastened			
	Vapor Retarder	Optional: 4-6 mil Poly or V-Force (Primer) over 1/4" DensDeck			
Deck	22 - 16 ga., 72" max span, 33 ksi				

120 PSF

Membrane: LS-FR (45 or 60 mil.), LS-FR PT (60 mil.), Platinum (90 mil.) or Platinum PT (90 mil.)

Attachment: Jet Bond Spray Adhesive, BA-2004, EPDM SFBA, SP LVOC BA, SP LVOC BA-1168

RoofNav #: 288109-0-0 Slope: 1/4" Uplift: 120 psf Internal Fire: 1 External Fire: A Hail: SH	Cover Board	ISOGARD HD			
		1/2"			
	Attachment	24 Heavy-Duty or All Purpose Fasteners and Plates			
	Insulation	ISO 95+ GL (F/T)	ISOGARD GL (F/T)		
		1.5" - 4"	2.3" - 13"		
	Attachment	Common Fastened			
	Vapor Retarder	Optional: 4-6 mil Poly or V-Force (Primer) over 1/4" DensDeck			
Deck	22 - 18 ga., Wide Rib, 72" max span, 33 ksi				

RubberGard EPDM (Adhered) – Steel Deck – ISO (Attached) – ISOGARD HD/HD Comp. (Adhered)

75 PSF

Membrane: LS-FR (45 or 60 mil.), LS-FR PT (60 mil.), Platinum (90 mil.) or Platinum PT (90 mil.), MAX, MAX PT, MAX FR

Attachment: Jet Bond Spray Adhesive, BA-2004, EPDM SFBA, SP LVOC BA, SP LVOC BA-1168, WBBA-P

RoofNav #: 319423-0-0 Slope: ¼" Uplift: 75 psf Internal Fire: 1 External Fire: A Hail: SH	Cover Board	ISOGARD HD		ISOGARD HD Composite		
		½"		1" – 2.5"		
	Attachment	I.S.O. Spray R	I.S.O. Twin Pack	I.S.O. Stick	Twin Jet	
		12" o.c. beads				
	Insulation	ISO 95+ GL (F/T)	Resista (F/T)	ISOGARD GL (F/T)	ISOGARD CG (F/T)	
		2" - 12"	2" - 12"	2.3" - 13"	2.3" - 13"	
	Attachment	8 Heavy-Duty or All Purpose Fasteners and Plates				
	Vapor Retarder	Optional: 4-6 mil Poly or V-Force (Primer) over ¼" DensDeck				
Deck	22 – 16 ga., 72" max span, 33 ksi					

Membrane: LS-FR (45 or 60 mil.), LS-FR PT (60 mil.), Platinum (90 mil.) or Platinum PT (90 mil.)

Attachment: Jet Bond Spray Adhesive, BA-2004, EPDM SFBA, SP LVOC BA, SP LVOC BA-1168, WBBA-P

RoofNav #: 319379-0-0 Slope: ½" Uplift: 75 psf Internal Fire: 1 External Fire: A Hail: SH	Cover Board	ISOGARD HD		ISOGARD HD Composite		
		½"		1" – 2.5"		
	Attachment	I.S.O. Spray R	I.S.O. Twin Pack	I.S.O. Stick	Twin Jet	
		12" o.c. beads				
	Insulation	ISO 95+ GL (F/T)	Resista (F/T)	ISOGARD GL (F/T)	ISOGARD CG (F/T)	
		2" - 4"	2" - 4"	2.3" - 13"	2.3" - 13"	
	Attachment	8 Heavy-Duty or All Purpose Fasteners and Plates				
	Vapor Retarder	Optional: 4-6 mil Poly or V-Force (Primer) over ¼" DensDeck				
Deck	22 – 16 ga., 72" max span, 33 ksi					

90 PSF

Membrane: LS-FR (45 or 60 mil.), LS-FR PT (60 mil.), Platinum (90 mil.) or Platinum PT (90 mil.), MAX, MAX PT, MAX FR

Attachment: Jet Bond Spray Adhesive, BA-2004, EPDM SFBA, SP LVOC BA, SP LVOC BA-1168, WBBA-P

RoofNav #: 319423-0-0 Slope: ¼" Uplift: 90 psf Internal Fire: 1 External Fire: A Hail: SH	Cover Board	ISOGARD HD		ISOGARD HD Composite		
		½"		1" – 2.5"		
	Attachment	I.S.O. Spray R	I.S.O. Twin Pack	I.S.O. Stick	Twin Jet	
		12" o.c. beads				
	Insulation	ISO 95+ GL (F/T)	Resista (F/T)	ISOGARD GL (F/T)	ISOGARD CG (F/T)	
		1.5" - 12"	1.5" - 12"	2.3" - 13"	2.3" - 13"	
	Attachment	16 Heavy-Duty or All Purpose Fasteners and Plates				
	Vapor Retarder	Optional: 4-6 mil Poly or V-Force (Primer) over ¼" DensDeck				
Deck	22 – 16 ga., 72" max span, 33 ksi					

Membrane: LS-FR (45 or 60 mil.), LS-FR PT (60 mil.), Platinum (90 mil.) or Platinum PT (90 mil.)

Attachment: Jet Bond Spray Adhesive, BA-2004, EPDM SFBA, SP LVOC BA, SP LVOC BA-1168, WBBA-P

RoofNav #: 384818-0-0 Slope: ½" Uplift: 90 psf Internal Fire: 1 External Fire: A Hail: SH	Cover Board	ISOGARD HD		ISOGARD HD Composite		
		½"		1" – 2.5"		
	Attachment	I.S.O. Spray R	I.S.O. Twin Pack	I.S.O. Stick	Twin Jet	
		12" o.c. beads				
	Insulation	ISO 95+ GL (F/T)	Resista (F/T)	ISOGARD GL (F/T)	ISOGARD CG (F/T)	
		2.2" - 12"	2.2" - 12"	2.3" - 13"	2.3" - 13"	
	Attachment	8 Heavy-Duty or All Purpose Fasteners and Plates				
	Vapor Retarder	V-Force (Primer) over ¼" DensDeck/DenDeck Prime or ⅜" Securock				
Deck	22 – 16 ga., 72" max span, 33 ksi					

120 PSF

Membrane: LS-FR (45 or 60 mil.), LS-FR PT (60 mil.), Platinum (90 mil.) or Platinum PT (90 mil.), MAX, MAX PT, MAX FR

Attachment: Jet Bond Spray Adhesive, BA-2004, SP LVOC BA, WBBA-P

RoofNav #: 320251-0-0 Slope: 1/4" Uplift: 120 psf Internal Fire: 1 External Fire: A Hail: SH	Cover Board	ISOGARD HD		ISOGARD HD Composite		
		1/2"		1" - 2.5"		
	Attachment	I.S.O. Spray R	I.S.O. Twin Pack	I.S.O. Stick	Twin Jet	
		4" o.c. beads				
	Insulation	ISO 95+ GL (F/T)	Resista (F/T)	ISOGARD GL (F/T)	ISOGARD CG (F/T)	
		2" - 4"	2" - 4"	2.3" - 13"	2.3" - 13"	
	Attachment	32 Heavy-Duty or All Purpose Fasteners and Plates				
	Vapor Retarder	Optional: 4-6 mil Poly or V-Force (Primer) over 1/4" DensDeck				
Deck	22 - 18 ga., Wide Rib, 72" max span, 33 ksi					

Membrane: LS-FR (45 or 60 mil.), LS-FR PT (60 mil.), MAX, MAX PT, MAX FR

Attachment: Jet Bond Spray Adhesive, BA-2004, SP LVOC BA, WBBA-P

RoofNav #: 320273-0-0 Slope: 1/4" Uplift: 120 psf Internal Fire: 1 External Fire: A Hail: SH	Cover Board	ISOGARD HD		ISOGARD HD Composite		
		1/2"		1" - 2.5"		
	Attachment	I.S.O. Spray R	I.S.O. Twin Pack	I.S.O. Stick	Twin Jet	
		12" o.c. beads				
	Insulation	ISO 95+ GL (F/T)	Resista (F/T)	ISOGARD GL (F/T)	ISOGARD CG (F/T)	
		2" - 12"	2" - 12"	2.3" - 13"	2.3" - 13"	
	Attachment	32 Heavy-Duty or All Purpose Fasteners and Plates				
	Vapor Retarder	Optional: 4-6 mil Poly or V-Force (Primer) over 1/4" DensDeck				
Deck	22 - 18 ga., Wide Rib, 72" max span, 33 ksi					

Membrane: LS-FR (45 or 60 mil.), LS-FR PT (60 mil.), Platinum (90 mil.) or Platinum PT (90 mil.)

Attachment: Jet Bond Spray Adhesive, BA-2004, SP LVOC BA, WBBA-P

RoofNav #: 320275-0-0 Slope: 1/2" Uplift: 120 psf Internal Fire: 1 External Fire: A Hail: SH	Cover Board	ISOGARD HD		ISOGARD HD Composite		
		1/2"		1" - 2.5"		
	Attachment	I.S.O. Spray R	I.S.O. Twin Pack	I.S.O. Stick	Twin Jet	
		4" o.c. beads				
	Insulation	ISO 95+ GL (F/T)	ISOGARD GL (F/T)			
		2" - 4"	2.3" - 13"			
	Attachment	32 Heavy-Duty or All Purpose Fasteners and Plates				
	Vapor Retarder	Optional: 4-6 mil Poly or V-Force (Primer) over 1/4" DensDeck				
Deck	22 - 18 ga., Wide Rib, 72" max span, 33 ksi					

165 PSF

Membrane: LS-FR (45 or 60 mil.), LS-FR PT (60 mil.), Platinum (90 mil.) or Platinum PT (90 mil.)

Attachment: Jet Bond Spray Adhesive, BA-2004, SP LVOC BA, SP LVOC BA-1168, WBBA-P

RoofNav #: 340759-0-0 Slope: 1/2" Uplift: 165 psf Internal Fire: 1 External Fire: A Hail: SH	Cover Board	ISOGARD HD		ISOGARD HD Composite		
		1/2"		1" - 2.5"		
	Attachment	I.S.O. Spray R	I.S.O. Twin Pack	I.S.O. Stick	Twin Jet	
		6" o.c. beads				
	Insulation	ISO 95+ GL (F/T)	ISOGARD GL (F/T)			
		(Top) 2" - 4"	Optional: 2" 1/2" - 8"	(Top) 2.3" - 13"	Optional: 2.3" 1/2" - 13"	
	Attachment	20 Heavy-Duty or All Purpose Fasteners and Plates				
	Vapor Retarder	Optional: 4-6 mil Poly				
Deck	22 - 18 ga., Wide Rib, 72" max span, 33 ksi					

180 PSF

Membrane: LS-FR (45 or 60 mil.), LS-FR PT (60 mil.), Platinum (90 mil.) or Platinum PT (90 mil.), MAX, MAX PT, MAX FR

Attachment: Jet Bond Spray Adhesive

RoofNav #: 464181-0-0 Slope: 1/4" Uplift: 180 psf Internal Fire: 1 External Fire: A Hail: SH	Cover Board	ISOGARD HD			
		1/2"			
	Attachment	I.S.O. Spray R	I.S.O. Twin Pack	I.S.O. Stick	Twin Jet
		12" o.c. beads			
	Insulation	ISO 95+ GL (F/T)		ISOGARD GL (F/T)	
		2" - 4"		2.3" - 13"	
	Attachment	32 Heavy-Duty or All Purpose Fasteners and Plates			
Vapor Retarder	Optional: 4-6 mil Poly or V-Force (Primer) over 1/4" DensDeck				
Deck	20 - 18 ga., Wide Rib, 72" max span, 33 ksi; 22 ga., Wide Rib, 69" max span, 33 ksi; 22 - 18 ga., Wide Rib, 72" max span, 80 ksi				

Membrane: LS-FR (45 or 60 mil.), LS-FR PT (60 mil.), MAX, MAX PT, MAX FR

Attachment: Jet Bond Spray Adhesive

RoofNav #: 464182-0-0 Slope: 1/4" Uplift: 180 psf Internal Fire: 1 External Fire: A Hail: SH	Cover Board	ISOGARD HD			
		1/2"			
	Attachment	I.S.O. Spray R	I.S.O. Twin Pack	I.S.O. Stick	Twin Jet
		12" o.c. beads			
	Insulation	ISO 95+ GL (F/T)		ISOGARD GL (F/T)	
		2" - 12"		2.3" - 13"	
	Attachment	32 Heavy-Duty or All Purpose Fasteners and Plates			
Vapor Retarder	Optional: 4-6 mil Poly or V-Force (Primer) over 1/4" DensDeck				
Deck	20 - 18 ga., Wide Rib, 72" max span, 33 ksi; 22 ga., Wide Rib, 69" max span, 33 ksi; 22 - 18 ga., Wide Rib, 72" max span, 80 ksi				

Membrane: LS-FR (45 or 60 mil.), LS-FR PT (60 mil.), Platinum (90 mil.) or Platinum PT (90 mil.)

Attachment: Jet Bond Spray Adhesive

RoofNav #: 464184-0-0 Slope: 1/2" Uplift: 180 psf Internal Fire: 1 External Fire: A Hail: SH	Cover Board	ISOGARD HD			
		1/2"			
	Attachment	I.S.O. Spray R	I.S.O. Twin Pack	I.S.O. Stick	Twin Jet
		12" o.c. beads			
	Insulation	ISO 95+ GL (F/T)		ISOGARD GL (F/T)	
		2" - 12"		2.3" - 13"	
	Attachment	32 Heavy-Duty or All Purpose Fasteners and Plates			
Vapor Retarder	Optional: 4-6 mil Poly or V-Force (Primer) over 1/4" DensDeck				
Deck	20 - 18 ga., Wide Rib, 72" max span, 33 ksi; 22 ga., Wide Rib, 69" max span, 33 ksi; 22 - 18 ga., Wide Rib, 72" max span, 80 ksi				

EPDM (Adhered) – Steel Deck – ISO (Attached) – ISO (Adhered) – ISOGARD HD/HD Comp. (Adhered)

75 PSF

Membrane: LS-FR (45 or 60 mil.), LS-FR PT (60 mil.), Platinum (90 mil.) or Platinum PT (90 mil.)

Attachment: Jet Bond Spray Adhesive, BA-2004, EPDM SFBA, SP LVOC BA, SP LVOC BA-1168, WBBA-P

RoofNav #: 385736-0-0 Slope: 1/2" Uplift: 75 psf Internal Fire: 1 External Fire: A Hail: SH	Cover Board	ISOGARD HD		ISOGARD HD Composite		
		1/2"		1" – 2.5"		
	Attachment	I.S.O. Spray R	I.S.O. Twin Pack	I.S.O. Stick	Twin Jet	
		12" o.c. beads				
	Insulation	ISO 95+ GL (F/T)	Resista (F/T)	ISOGARD GL (F/T)	ISOGARD CG (F/T)	
		1/2" – 9.8"	1/2" -9.8"	2.3" - 13"	2.3" - 13"	
	Attachment	I.S.O. Spray R	I.S.O. Twin Pack	I.S.O. Stick	Twin Jet	
		12" o.c. beads				
	Insulation	ISO 95+ GL (F/T)	Resista (F/T)	ISOGARD GL (F/T)	ISOGARD CG (F/T)	
		2" - 4"	2" - 4"	2.3" - 13"	2.3" - 13"	
Attachment	8 Heavy-Duty or All Purpose Fasteners and Plates					
Vapor Retarder	V-Force (Primer) over 1/4" DensDeck/DensDeck Prime or 3/8" Securock					
Deck	22 – 16 ga., 72" max span, 33 ksi					

90 PSF

Membrane: LS-FR (45 or 60 mil.), LS-FR PT (60 mil.), Platinum (90 mil.) or Platinum PT (90 mil.)

Attachment: Jet Bond Spray Adhesive, BA-2004, EPDM SFBA, SP LVOC BA, SP LVOC BA-1168, WBBA-P

RoofNav #: 384816-0-0 Slope: 1/2" Uplift: 90 psf Internal Fire: 1 External Fire: A Hail: SH	Cover Board	ISOGARD HD		ISOGARD HD Composite		
		1/2"		1" – 2.5"		
	Attachment	I.S.O. Spray R	I.S.O. Twin Pack	I.S.O. Stick	Twin Jet	
		12" o.c. beads				
	Insulation	ISO 95+ GL (F/T)	Resista (F/T)	ISOGARD GL (F/T)	ISOGARD CG (F/T)	
		1/2" – 9.8"	1/2" -9.8"	2.3" - 13"	2.3" - 13"	
	Attachment	I.S.O. Spray R	I.S.O. Twin Pack	I.S.O. Stick	Twin Jet	
		12" o.c. beads				
	Insulation	ISO 95+ GL (F/T)	Resista (F/T)	ISOGARD GL (F/T)	ISOGARD CG (F/T)	
		2.2" - 4"	2.2" - 4"	2.3" - 13"	2.3" - 13"	
Attachment	8 Heavy-Duty or All Purpose Fasteners and Plates					
Vapor Retarder	V-Force (Primer) over 1/4" DensDeck/DensDeck Prime or 3/8" Securock					
Deck	22 – 16 ga., 72" max span, 33 ksi					

Membrane: LS-FR (45 or 60 mil.), LS-FR PT (60 mil.), Platinum (90 mil.) or Platinum PT (90 mil.), MAX, MAX PT, MAX FR

Attachment: Jet Bond Spray Adhesive, BA-2004, EPDM SFBA, SP LVOC BA, SP LVOC BA-1168, WBBA-P

RoofNav #: 307701-0-0 Slope: 1/4" Uplift: 90 psf Internal Fire: 1 External Fire: A Hail: SH	Cover Board	ISOGARD HD		ISOGARD HD Composite		
		1/2"		1" – 2.5"		
	Attachment	I.S.O. Spray R	I.S.O. Twin Pack	I.S.O. Stick	Twin Jet	
		12" o.c. beads				
	Insulation	ISO 95+ GL (F/T)	Resista (F/T)	ISOGARD GL (F/T)	ISOGARD CG (F/T)	
		1"(F)/1/2"(T) – 4"	1"(F)/1/2"(T) – 4"	2.3" - 13"	2.3" - 13"	
	Attachment	I.S.O. Spray R	I.S.O. Twin Pack	I.S.O. Stick	Twin Jet	
		12" o.c. beads				
	Insulation	ISO 95+ GL (F/T)	Resista (F/T)	ISOGARD GL (F/T)	ISOGARD CG (F/T)	
		1.5" - 8"	1.5" - 8"	2.3" - 13"	2.3" - 13"	
Attachment	16 Heavy-Duty or All Purpose Fasteners and Plates					
Vapor Retarder	Optional: 4-6 mil Poly or V-Force (Primer) over 1/4" DensDeck					
Deck	22 – 16 ga., 72" max span, 33 ksi					

210 PSF

Membrane: LS-FR (45 or 60 mil.), LS-FR PT (60 mil.), Platinum (90 mil.) or Platinum PT (90 mil.), MAX, MAX PT, MAX FR

Attachment: Jet Bond Spray Adhesive, BA-2004 Ahesive, SP LVOC BA, SP LVOC BA-1168, WBBA-P

RoofNav #: 307969-0-0 Slope: 1/4" Uplift: 210 psf Internal Fire: 1 External Fire: A Hail: SH	Cover Board	ISOGARD HD		ISOGARD HD Composite		
		1/2"		1" - 2.5"		
	Attachment	I.S.O. Spray R	I.S.O. Twin Pack	I.S.O. Stick	Twin Jet	
		6" o.c. beads				
	Insulation	ISO 95+ GL (F/T)	Resista (F/T)	ISOGARD GL (F/T)	ISOGARD CG (F/T)	
		1.5" - 4"	1.5" - 4"	2.3" - 13"	2.3" - 13"	
	Attachment	I.S.O. Spray R	I.S.O. Twin Pack	I.S.O. Stick	Twin Jet	
		6" o.c. beads				
	Insulation	ISO 95+ GL (F/T)	Resista (F/T)	ISOGARD GL (F/T)	ISOGARD CG (F/T)	
		2" - 4"	2" - 4"	2.3" - 13"	2.3" - 13"	
Attachment	32 Heavy-Duty or All Purpose Fasteners and Plates					
Vapor Retarder	V-Force (Primer) over 1/4" DensDeck/DensDeck Prime or 3/8" Securock					
Deck	20 - 18 ga., Wide Rib, 72" max span, 33 ksi; 22 ga., Wide Rib, 64" max span, 33 ksi; 22 - 18 ga., Wide Rib, 72" max span, 80 ksi					

Membrane: LS-FR (45 or 60 mil.), LS-FR PT (60 mil.), Platinum (90 mil.) or Platinum PT (90 mil.)

Attachment: Jet Bond Spray Adhesive, BA-2004, SP LVOC BA, SP LVOC BA-1168, WBBA-P

RoofNav #: 308026-0-0 Slope: 1/2" Uplift: 210 psf Internal Fire: 1 External Fire: A Hail: SH	Cover Board	ISOGARD HD		ISOGARD HD Composite		
		1/2"		1" - 2.5"		
	Attachment	I.S.O. Spray R				
		6" o.c. beads				
	Insulation	ISO 95+ GL (F/T)	Resista (F/T)	ISOGARD GL (F/T)	ISOGARD CG (F/T)	
		1.5" - 4"	1.5" - 4"	2.3" - 13"	2.3" - 13"	
	Attachment	I.S.O. Spray R				
		6" o.c. beads				
	Insulation	ISO 95+ GL (F/T)	Resista (F/T)	ISOGARD GL (F/T)	ISOGARD CG (F/T)	
		2" - 4"	2" - 4"	2.3" - 13"	2.3" - 13"	
Attachment	32 Heavy-Duty or All Purpose Fasteners and Plates					
Vapor Retarder	V-Force (Primer) over 1/4" DensDeck/DensDeck Prime or 3/8" Securock					
Deck	20 - 18 ga., Wide Rib, 72" max span, 33 ksi; 22 ga., Wide Rib, 64" max span, 33 ksi; 22 - 18 ga., Wide Rib, 72" max span, 80 ksi					

EPDM (Adhered) - Steel Deck - ISO (Attached) - Gypsum Cover Board (Adhered)

75 PSF

Membrane: LS-FR (45 or 60 mil.), LS-FR PT (60 mil.), Platinum (90 mil.) or Platinum PT (90 mil.)

Attachment: Jet Bond Spray Adhesive, BA-2004, EPDM SFBA, SP LVOC BA, SP LVOC BA-1168, WBBA-P

RoofNav #: 385738-0-0 Slope: 1/2" Uplift: 75 psf Internal Fire: 1 External Fire: A Hail: SH	Cover Board	DensDeck Prime		Securock		
		1/4"		1/4"		
	Attachment	I.S.O. Spray R	I.S.O. Twin Pack	I.S.O. Stick	Twin Jet	
		12" o.c. beads				
	Insulation	ISO 95+ GL (F/T)	Resista (F/T)	ISOGARD GL (F/T)	ISOGARD CG (F/T)	
		2" - 12"	2" - 12"	2.3" - 13"	2.3" - 13"	
	Attachment	8 Heavy-Duty or All Purpose Fasteners and Plates				
	Vapor Retarder	V-Force (Primer) over 1/4" DensDeck/DensDeck Prime or 3/8" Securock				
	Deck	22 - 16 ga., 72" max span, 33 ksi				

90 PSF

Membrane: LS-FR (45 or 60 mil.), LS-FR PT (60 mil.), Platinum (90 mil.) or Platinum PT (90 mil.)

Attachment: Jet Bond Spray Adhesive, BA-2004, EPDM SFBA, SP LVOC BA, SP LVOC BA-1168, WBBA-P

RoofNav #: 384818-0-0 Slope: 1/2" Uplift: 90 psf Internal Fire: 1 External Fire: A Hail: SH	Cover Board	DensDeck Prime		Securock	
		1/4"		1/4"	
	Attachment	I.S.O. Spray R	I.S.O. Twin Pack	I.S.O. Stick	Twin Jet
		12" o.c. beads			
	Insulation	ISO 95+ GL (F/T)	Resista (F/T)	ISOGARD GL (F/T)	ISOGARD CG (F/T)
		2.2" - 12"	2.2" - 12"	2.3" - 13"	2.3" - 13"
	Attachment	8 Heavy-Duty or All Purpose Fasteners and Plates			
	Vapor Retarder	V-Force (Primer) over 1/4" DensDeck/DensDeck Prime or 3/8" Securock			
Deck	22 - 16 ga., 72" max span, 33 ksi				

EPDM (Adhered) - Steel Deck - ISO (Attached) - ISO (Adhered) - Gypsum Cover Board (Adhered)

75 PSF

Membrane: LS-FR (45 or 60 mil.), LS-FR PT (60 mil.), Platinum (90 mil.) or Platinum PT (90 mil.)

Attachment: Jet Bond Spray Adhesive, BA-2004, EPDM SFBA, SP LVOC BA, SP LVOC BA-1168, WBBA-P

RoofNav #: 385736-0-0 Slope: 1/2" Uplift: 75 psf Internal Fire: 1 External Fire: A Hail: SH	Cover Board	DensDeck Prime		Securock	
		1/4"		1/4"	
	Attachment	I.S.O. Spray R	I.S.O. Twin Pack	I.S.O. Stick	Twin Jet
		12" o.c. beads			
	Insulation	ISO 95+ GL (F/T)	Resista (F/T)	ISOGARD GL (F/T)	ISOGARD CG (F/T)
		1/2" - 9.8"	1/2" - 9.8"	2.3" - 13"	2.3" - 13"
	Attachment	I.S.O. Spray R	I.S.O. Twin Pack	I.S.O. Stick	Twin Jet
		12" o.c. beads			
Insulation	ISO 95+ GL (F/T)	Resista (F/T)	ISOGARD GL (F/T)	ISOGARD CG (F/T)	
	2" - 4"	2" - 4"	2.3" - 13"	2.3" - 13"	
Attachment	8 Heavy-Duty or All Purpose Fasteners and Plates				
Vapor Retarder	V-Force (Primer) over 1/4" DensDeck/DensDeck Prime or 3/8" Securock				
Deck	22 - 16 ga., 72" max span, 33 ksi				

90 PSF

Membrane: RubberGard LS-FR (45 or 60 mil.), RubberGard LS-FR PT (60 mil.), Platinum (90 mil.) or Platinum PT (90 mil.)

Attachment: Jet Bond Spray Adhesive, BA-2004 Bonding Adhesive, EPDM SFBA, SP LVOC BA, SP LVOC BA-1168, WBBA-P

RoofNav #: 384816-0-0 Slope: 1/2" Uplift: 90 psf Internal Fire: 1 External Fire: A Hail: SH	Cover Board	DensDeck Prime		Securock	
		1/4"		1/4"	
	Attachment	I.S.O. Spray R	I.S.O. Twin Pack	I.S.O. Stick	Twin Jet
		12" o.c. beads			
	Insulation	ISO 95+ GL (F/T)	Resista (F/T)	ISOGARD GL (F/T)	ISOGARD CG (F/T)
		1/2" - 9.8"	1/2" - 9.8"	2.3" - 13"	2.3" - 13"
	Attachment	I.S.O. Spray R	I.S.O. Twin Pack	I.S.O. Stick	Twin Jet
		12" o.c. beads			
Insulation	ISO 95+ GL (F/T)	Resista (F/T)	ISOGARD GL (F/T)	ISOGARD CG (F/T)	
	2.2" - 4"	2.2" - 4"	2.3" - 13"	2.3" - 13"	
Attachment	8 Heavy-Duty or All Purpose Fasteners and Plates				
Vapor Retarder	V-Force (Primer) over 1/4" DensDeck/DensDeck Prime or 3/8" Securock				
Deck	22 - 16 ga., 72" max span, 33 ksi				

EPDM LS-FR (Adhered) – Concrete Deck – Vapor Barrier – ISO (Adhered)

Uplift	Deck	Cover Board / Insulation	Cover Board / Insulation Attachment	Membrane	Membrane Attachment	RoofNav
1-75 IF: NC EF: A Slope: ½"	Concrete Min. 2,500 psi Min. 2" thick	Insulation: 1.5"-36" thick, 4'x4' boards ISO 95+ GL ISO 95+ GL (Taper) RESISTA Vapor Barrier: V-Force (Self-Adhered)	Adhered at 12" o.c.: ISO Spray R	.045 mil. min. RubberGard LS-FR .060 mil. RubberGard LS-FR PT	BA-2004 Single-Ply LVOC Single-Ply LVOC 1168 WBBA-P	371174-0-0
					EPDM SFBA	384176-0-0
1-75 IF: NC EF: A Slope: ¼"	Concrete Min. 2,500 psi Min. 2" thick	Cover Board: ½", 4'x4' boards, ISOGARD HD 1"-2.5", 4'x4' boards, ISOGARD HD COMPOSITE Insulation: 1.5"-36" thick, 4'x4' boards ISO 95+ GL ISO 95+ GL (Taper) RESISTA Vapor Barrier: V-Force (Self-Adhered)	Adhered at 12" o.c.: ISO Spray R	.045 mil. min. RubberGard LS-FR .060 mil. RubberGard LS-FR PT	BA-2004 EPDM SFBA Single-Ply LVOC Single-Ply LVOC 1168 WBBA-P	371151-0-0
1-90 IF: NC EF: A Slope: ½"	Concrete Min. 2,500 psi Min. 2" thick	Insulation: 1.5"-36" thick, 4'x4' boards ISO 95+ GL ISO 95+ GL (Taper) RESISTA Vapor Barrier: V-Force (Self-Adhered)	Adhered at 12" o.c.: ISO Spray R	.045 mil. min. RubberGard LS-FR .060 mil. RubberGard LS-FR PT	BA-2004 Single-Ply LVOC Single-Ply LVOC 1168 WBBA-P	370560-0-0
					EPDM SFBA	384154-0-0
1-255 IF: NC EF: A Slope: ½"	Concrete Min. 2,500 psi Min. 2" thick	Cover Board: .438"-.5" APA Rated OSB Insulation: 1.5"-36" thick, 4'x4' boards ISO 95+ GL ISO 95+ GL (Taper) RESISTA	Adhered at 12" o.c.: ISO Spray R	.045 mil. min. RubberGard LS-FR .060 mil. RubberGard LS-FR PT	BA-2004 EPDM SFBA Single-Ply LVOC Single-Ply LVOC 1168	308435-0-0
1-315 IF: NC EF: A Slope: ½"	Concrete Min. 2,500 psi Min. 2" thick	Insulation: 1.5"-36" thick, 4'x4' boards ISO 95+ GL ISO 95+ GL (Taper)	Adhered at 12" o.c.: ISO Twin Pack	.045 mil. min. RubberGard LS-FR .060 mil. RubberGard LS-FR PT	BA-2004 Single-Ply LVOC Single-Ply LVOC 1168	102219-0-0
1-330 IF: NC EF: A Slope: 1"	Concrete Min. 2,500 psi Min. 2" thick	Cover Board: ¼" min, 4'x4' boards, DensDeck/Securock Insulation: 1.5"-36" thick, 4'x4' boards ISO 95+ GL ISO 95+ GL (Taper)	Cover Board and Insulation: Adhered at 20-25 lb/sq. Hot Asphalt Primed Deck: Concrete Primer, Asphaltic Permeable	.045 mil. min. RubberGard LS-FR .060 mil. RubberGard LS-FR PT	BA-2004 Single-Ply LVOC Single-Ply LVOC 1168	47789-0-0
1-465 IF: NC EF: A Slope: 1"	Concrete Min. 2,500 psi Min. 2" thick	Insulation: ¼" min, 4'x4' boards, DensDeck/Securock	Adhered at 12" o.c.: ISO Twin Pack	.045 mil. min. RubberGard LS-FR .060 mil. RubberGard LS-FR PT	BA-2004 Single-Ply LVOC Single-Ply LVOC 1168	100971-0-0
1-465 IF: NC EF: A Slope: 1"	Concrete Min. 2,500 psi Min. 2" thick	Cover Board: ¼" min, 4'x4' boards, DensDeck/DensDeck Prime/ Securock Insulation: 1.5"-36" thick, 4'x4' boards ISO 95+ GL ISO 95+ GL (Taper)	Adhered at 12" o.c.: ISO Stick/Twin Jet Primed Deck: Concrete Primer, Asphaltic Permeable	.045 mil. min. RubberGard LS-FR .060 mil. RubberGard LS-FR PT	BA-2004 Single-Ply LVOC	228430-0-0

EPDM LS-FR (Adhered) – Concrete Deck – Vapor Barrier – ISO (Adhered) (Continued)

1-525 IF: NC EF: A Slope: 1/2"	Concrete Min. 2,500 psi Min. 2" thick	Insulation: 1.5"-36" thick, 4'x4' boards ISO 95+ GL ISO 95+ GL (Taper) Vapor Barrier: V-Force (Self-Adhered) Primer (permeable) : SA-LVOC SA-SB V-Force SB	Adhered at 12" o.c.: ISO Spray R ISO Twin Pack ISO Stick/Twin Jet	.045 mil. min. RubberGard LS-FR .060 mil. RubberGard LS-FR PT	BA-2004 Single-Ply LVOC Single-Ply LVOC 1168	297178-0-0
1-525 IF: NC EF: A Slope: 1/2"	Concrete Min. 2,500 psi Min. 2" thick	Cover Board: 1/2", 4'x4' boards, ISOGARD HD 1"-2.5", 4'x4' boards, ISOGARD HD COMPOSITE Insulation: 1.5"-36" thick, 4'x4' boards ISO 95+ GL ISO 95+ GL (Taper) Vapor Barrier: V-Force (Self-Adhered) Primer (permeable) : SA-LVOC SA-SB V-Force SB	Adhered at 12" o.c.: ISO Spray R ISO Twin Pack ISO Stick/Twin Jet	.045 mil. min. RubberGard LS-FR .060 mil. RubberGard LS-FR PT	BA-2004 SFBA Single-Ply LVOC WBBA-P	298272-0-0
1-525 IF: NC EF: A Slope: 1/2"	Concrete Min. 2,500 psi Min. 2" thick	Cover Board: 1/2", 4'x4' boards DensDeck DensDeck Prime Securock Insulation: 1.5"-36" thick, 4'x4' boards ISO 95+ GL ISO 95+ GL (Taper) Vapor Barrier: V-Force (Self-Adhered) Primer (permeable) : SA-LVOC SA-SB V-Force SB	Adhered at 12" o.c.: ISO Spray R ISO Twin Pack ISO Stick/Twin Jet	.045 mil. min. RubberGard LS-FR .060 mil. RubberGard LS-FR PT	BA-2004 Single-Ply LVOC	297159-0-0
1-540 IF: NC EF: A Slope: 1/2"	Concrete Min. 2,500 psi Min. 2" thick	Insulation: 1.5"-36" thick, 4'x4' boards ISO 95+ GL ISO 95+ GL (Taper)	Adhered at 12" o.c.: ISO Stick/Twin Jet Primed Deck: Concrete Primer, Asphaltic Permeable	.045 mil. min. RubberGard LS-FR .060 mil. RubberGard LS-FR PT	BA-2004 Single-Ply LVOC	228465-0-0
1-555 IF: NC EF: A Slope: 1/2"	Concrete Min. 2,500 psi Min. 2" thick	Cover Board: 1/2", 4'x4' boards ISOGARD HD 1"-2.5", 4'x4' boards ISOGARD HD Composite Insulation: 1"-36" thick, 4'x4' boards ISO 95+ GL ISO 95+ GL (Taper)	Adhered at 12" o.c.: ISO Spray R	.045 mil. min. RubberGard LS-FR .060 mil. RubberGard LS-FR PT	BA-2004 EPDM SFBA Single-Ply LVOC Single-Ply LVOC 1168 WBBA-P	308236-0-0
1-675 IF: NC EF: A Slope: 1/2"	Concrete Min. 2,500 psi Min. 2" thick	Insulation: 1.5"-36" thick, 4'x4' boards ISO 95+ GL ISO 95+ GL (Taper) Vapor Barrier: V-Force (Self-Adhered) Primer (permeable) : SA-LVOC SA-SB V-Force SB	Adhered at 12" o.c.: ISO Spray R ISO Twin Pack ISO Stick/Twin Jet	.045 mil. min. RubberGard LS-FR .060 mil. RubberGard LS-FR PT	BA-2004 Single-Ply LVOC	296334-0-0

EPDM LS-FR (Adhered) – Concrete Deck – Vapor Barrier – ISO (Adhered) (Continued)

1-690 IF: NC EF: A Slope: 1"	Concrete Min. 2,500 psi Min. 2" thick	Cover Board: ¼", 4'x4' boards DensDeck Securock Insulation: 1.5"-36" thick, 4'x4' boards ISO 95+ GL ISO 95+ GL (Taper)	Full Spray: ISO Spray R 1.04 gal/square	.045 mil. min. RubberGard LS-FR .060 mil. RubberGard LS-FR PT	BA-2004 Single-Ply LVOC	135774-0-0
1-780 IF: NC EF: A Slope: ½"		Insulation: 1.5"-36" thick, 4'x4' boards ISO 95+ GL ISO 95+ GL (Taper)	Full Spray: ISO Spray R 1.04 gal/square	.045 mil. min. RubberGard LS-FR .060 mil. RubberGard LS-FR PT	BA-2004 Single-Ply LVOC Single-Ply LVOC 1168	62382-0-0

Re-Roof – EPDM LS-FR (Adhered) – Gypsum Deck – ISO/Cover Board (Adhered)

Uplift	Deck	Cover Board / Insulation	Cover Board / Insulation Attachment	Membrane	Membrane Attachment	RoofNav
1-90 IF: 1 EF: A Slope: ½"	Gypsum	Insulation: ¼", 4'x4' boards DensDeck Securock	Adhered at 12" o.c.: ISO Twin Pack	.045 mil. min. RubberGard LS-FR .060 mil. RubberGard LS-FR PT	BA-2004 Single-Ply LVOC Single-Ply LVOC 1168 WBBA-P	100864-0-0
1-90 IF: 1 EF: A Slope: 1"	Gypsum	Cover Board: ¼", 4'x4' boards DensDeck Securock Insulation (Top Layer): 1.5"-8" thick, 4'x4' boards ISO 95+ GL ISO 95+ GL (Taper) RESISTA Insulation (Bottom Layer): 1.5"-4" thick, 4'x4' boards ISO 95+ GL ISO 95+ GL (Taper) RESISTA	Adhered at 12" o.c.: ISO Twin Pack	.045 mil. min. RubberGard LS-FR .060 mil. RubberGard LS-FR PT	BA-2004 Single-Ply LVOC Single-Ply LVOC 1168 WBBA-P	100861-0-0
1-90 IF: 1 EF: A Slope: ¼"	Gypsum	Cover Board: ½", 4'x4' boards ISOGARD HD 1"-2.5", 4'x4' boards ISOGARD HD Composite Insulation: 1.5"-4" thick, 4'x4' boards ISO 95+ GL ISO 95+ GL (Taper) RESISTA	Adhered at 12" o.c.: ISO Twin Pack ISO Stick/Twin Jet	.045 mil. min. RubberGard LS-FR .060 mil. RubberGard LS-FR PT	BA-2004 Single-Ply LVOC Single-Ply LVOC 1168 WBBA-P	262899-0-0
1-90 IF: 1 EF: A Slope: ½"	Gypsum	Cover Board: ½", 4'x4' boards ISOGARD HD 1"-8", 4'x4' boards ISOGARD HD Composite Insulation: 1.5"-4" thick, 4'x4' boards ISO 95+ GL ISO 95+ GL (Taper) RESISTA	Adhered at 12" o.c.: ISO Spray R ISO Twin Pack ISO Stick/Twin Jet	.045 mil. min. RubberGard LS-FR .060 mil. RubberGard LS-FR PT	BA-2004 Single-Ply LVOC Single-Ply LVOC 1168 WBBA-P	420488-0-0

EPDM MAX/MAX FR (Adhered) – Concrete Deck – V-Force – ISO/Cover Board (Adhered)

Uplift	Deck	Cover Board / Insulation	Cover Board / Insulation Attachment	Membrane	Membrane Attachment	RoofNav
1-75 IF: NC EF: A Slope: ¼"	Concrete Min. 2,500 psi Min. 2" thick	Cover Board: ½", 4'x4' boards, ISOGARD HD 1"-2.5", 4x4 boards, ISOGARD HD COMPOSITE Insulation: 1.5"-36" thick, 4'x4' boards ISO 95+ GL ISO 95+ GL (Taper) RESISTA Vapor Barrier: V-Force (Self-Adhered)	Adhered at 12" o.c.: ISO Spray R	.045 mil. min. RubberGard MAX RubberGard MAX FR RubberGard MAX PT	BA-2004 SFBA Single-Ply LVOC Single-Ply LVOC 1168 WBBA-P	371151-0-0
1-255 IF: NC EF: A Slope: ½"	Concrete Min. 2,500 psi Min. 2" thick	Cover Board: .438"-.5" APA Rated OSB Insulation: 1.5"-36" thick, 4'x4' boards ISO 95+ GL ISO 95+ GL (Taper) RESISTA*	Adhered at 12" o.c.: ISO Spray R	.045 mil. min. RubberGard MAX RubberGard MAX PT	BA-2004 EPDM SFBA Single-Ply LVOC Single-Ply LVOC 1168	308435-0-0
1-315 IF: NC EF: A Slope: ¼"	Concrete Min. 2,500 psi	Insulation: 1.5"-36" thick, 4'x4' boards ISO 95+ GL ISO 95+ GL (Taper)	Adhered at 12" o.c.: ISO Twin Pack	.045 mil. min. RubberGard MAX RubberGard MAX PT	BA-2004 Single-Ply LVOC Single-Ply LVOC 1168	94602-0-0
1-315 IF: NC EF: A Slope: 2.5"	Min. 2" thick			.045 mil. min. RubberGard MAX FR		107603-0-0
1-330 IF: NC EF: A Slope: ½"	Concrete Min. 2,500 psi Min. 2" thick	Cover Board: ¼", 4'x4' boards DensDeck Securock Insulation: 1.5"-36" thick, 4'x4' boards ISO 95+ GL ISO 95+ GL (Taper)	Cover Board and Insulation: Adhered at 20-25 lb/sq. Hot Asphalt Primed Deck: Concrete Primer, Asphaltic Permeable	.045 mil. min. RubberGard MAX RubberGard MAX PT	BA-2004 Single-Ply LVOC Single-Ply LVOC 1168	47786-0-0
1-330 IF: NC EF: A Slope: 4"				.045 mil. min. RubberGard MAX FR		47802-0-0
1-465 IF: NC EF: A Slope: ½"	Concrete Min. 2,500 psi Min. 2" thick	Cover Board: ¼", 4'x4' boards DensDeck DensDeck Prime Securock Insulation: 1.5"-36" thick, 4'x4' boards ISO 95+ GL ISO 95+ GL (Taper)	Adhered at 12" o.c.: ISO Stick/Twin Jet Concrete Primer, Asphaltic Permeable	.045 mil. min. RubberGard MAX RubberGard MAX PT	BA-2004 Single-Ply LVOC	228424-0-0
1-465 IF: NC EF: A Slope: 4"				.045 mil. min. RubberGard MAX FR		228439-0-0
1-465 IF: NC EF: A Slope: ½"	Concrete Min. 2,500 psi Min. 2" thick	Insulation: ¼", 4'x4' boards DensDeck Securock	Adhered at 12" o.c.: ISO Twin Pack	.045 mil. min. RubberGard MAX RubberGard MAX PT	BA-2004 Single-Ply LVOC Single-Ply LVOC 1168	99842-0-0
1-465 IF: NC EF: A Slope: 4"				.045 mil. min. RubberGard MAX FR		110624-0-0

EPDM MAX/MAX FR (Adhered) – Concrete Deck – V-Force – ISO/Cover Board (Adhered) (Continued)

1-495 IF: NC EF: A Slope: 1/2"	Concrete Min. 2,500 psi Min. 2" thick	Cover Board: .438"-.5" APA Rated OSB Insulation: 1.5"-36" thick, 4'x4' boards ISO 95+ GL/ISO 95+ GL (Taper)	Adhered at 12" o.c.: ISO Stick/Twin Jet Concrete Primer, Asphaltic Permeable	.045 mil. min. RubberGard MAX FR	BA-2004 EPDM SFBA Single-Ply LVOC Single-Ply LVOC 1168	228350-0-0
1-525 IF: NC EF: A Slope: 1/4"	Concrete Min. 2,500 psi Min. 2" thick	Insulation: 1.5"-36" thick, 4'x4' boards ISO 95+ GL/ISO 95+ GL (Taper) RESISTA Vapor Barrier: V-Force (Self-Adhered) Primer (permeable): SA-LVOC/SA-SB V-Force SB	Adhered at 12" o.c.: ISO Spray R ISO Twin Pack ISO Stick/Twin Jet	.045 mil. min. RubberGard MAX RubberGard MAX PT	BA-2004 Single-Ply LVOC Single-Ply LVOC 1168	297177-0-0
1-525 IF: NC EF: A Slope: 1/4"	Concrete Min. 2,500 psi Min. 2" thick	Cover Board: 1/2", 4'x4' boards, ISOGARD HD 1"-2.5", 4'x4' boards, ISOGARD HD COMPOSITE Insulation: 1.5"-36" thick, 4'x4' boards ISO 95+ GL/ISO 95+ GL (Taper) Vapor Barrier: V-Force (Self-Adhered) Primer (permeable): SA-LVOC/SA-SB V-Force SB	Adhered at 12" o.c.: ISO Spray R ISO Twin Pack ISO Stick/Twin Jet	.045 mil. min. RubberGard MAX RubberGard MAX PT	BA-2004 SFBA Single-Ply LVOC WBBA-P	298271-0-0
1-525 IF: NC EF: A Slope: 1/2"	Concrete Min. 2,500 psi Min. 2" thick	Cover Board: 1/2", 4'x4' boards DensDeck/DensDeck Prime Securock Insulation: 1.5"-36" thick, 4'x4' boards ISO 95+ GL/ISO 95+ GL (Taper) Vapor Barrier: V-Force (Self-Adhered) Primer (permeable): SA-LVOC SA-SB V-Force SB	Adhered at 12" o.c.: ISO Spray R ISO Twin Pack ISO Stick/Twin Jet	.045 mil. min. RubberGard MAX .045 mil. RubberGard MAX PT	BA-2004 Single-Ply LVOC	297159-0-0
1-540 IF: NC EF: A Slope: 1/4"	Concrete Min. 2,500 psi Min. 2" thick	Insulation: 1.5"-36" thick, 4'x4' boards ISO 95+ GL ISO 95+ GL (Taper)	Adhered at 12" o.c.: ISO Stick/Twin Jet Concrete Primer, Asphaltic Permeable	.045 mil. min. RubberGard MAX	BA-2004 Single-Ply LVOC	228463-0-0
1-540 IF: NC EF: A Slope: 2.5"				.045 mil. min. RubberGard MAX PT		228469-0-0
1-555 IF: NC EF: A Slope: 1/4"	Concrete Min. 2,500 psi Min. 2" thick	Cover Board: 1/2", 4'x4' boards, ISOGARD HD 1"-2.5", 4'x4' boards, ISOGARD HD COMPOSITE Insulation: 1"-36" thick, 4'x4' boards ISO 95+ GL ISO 95+ GL (Taper) RESISTA	Adhered at 12" o.c.: ISO Spray R	.045 mil. min. RubberGard MAX	BA-2004 EPDM SFBA Single-Ply LVOC Single-Ply LVOC 1168 WBBA-P	308235-0-0
1-555 IF: NC EF: A Slope: 2.5"				.045 mil. min. RubberGard MAX PT		308241-0-0

EPDM MAX/MAX FR (Adhered) – Concrete Deck – V-Force – ISO/Cover Board (Adhered) (Continued)

1-675 IF: NC EF: A Slope: ¼"	Concrete Min. 2,500 psi Min. 2" thick	Insulation: 1.5"-36" thick, 4'x4' boards ISO 95+ GL ISO 95+ GL (Taper) RESISTA Vapor Barrier: V-Force (Self-Adhered) Primer (permeable): SA-LVOC SA-SB V-Force SB	Adhered at 12" o.c.: ISO Spray R ISO Twin Pack ISO Stick/Twin Jet	.045 mil. min. RubberGard MAX .045 mil. RubberGard MAX PT	BA-2004 Single-Ply LVOC	296332-0-0
1-690 IF: NC EF: A Slope: ½"	Concrete Min. 2,500 psi Min. 2" thick	Cover Board: ¼", 4'x4' boards DensDeck Securock Insulation: 1.5"-36" thick, 4'x4' boards ISO 95+ GL ISO 95+ GL (Taper)	Full Spray: ISO Spray R 1.04 gal/square Concrete Primer, Asphaltic Permeable	.045 mil. min. RubberGard MAX .045 mil. RubberGard MAX PT	BA-2004 Single-Ply LVOC	135965-0-0
1-690 IF: NC EF: A Slope: 2.5"				.045 mil. min. RubberGard MAX FR		135957-0-0
1-780 IF: NC EF: A Slope: ¼"	Concrete Min. 2,500 psi Min. 2" thick	Insulation: 1.5"-36" thick, 4'x4' boards ISOGARD ISO 95+ GL (Taper)	Full Spray: ISO Spray R 1.04 gal/square	.045 mil. min. RubberGard MAX .045 mil. RubberGard MAX PT	BA-2004 Single-Ply LVOC Single-Ply LVOC 1168	59191-0-0
1-780 IF: NC EF: A Slope: 2.5"						

Re-Roof - EPDM MAX/MAX FR (Adhered) – Gypsum Deck – ISO/Cover Board (Adhered)

Uplift	Deck	Cover Board / Insulation	C/I Attachment	Membrane	M Attachment	RoofNav
1-90 IF: 1 EF: A Slope: ½"	Gypsum	Insulation: ¼", 4'x4' boards DensDeck Securock	Adhered at 12" o.c.: ISO Twin Pack	.045 mil. min. RubberGard MAX .045 mil. RubberGard MAX PT	BA-2004 Single-Ply LVOC Single-Ply LVOC 1168 WBBA-P	99650-0-0
1-90 IF: 1 EF: A Slope: 4"	Gypsum	Insulation: ¼", 4'x4' boards DensDeck Securock	Adhered at 12" o.c.: ISO Twin Pack	.045 mil. min. RubberGard MAX FR	BA-2004 Single-Ply LVOC Single-Ply LVOC 1168	110330-0-0
1-90 IF: 1 EF: A Slope: ½"	Gypsum	Cover Board: ½", 4'x4' boards DensDeck Securock Insulation (Top Layer): 1.5"-8" thick, 4'x4' boards ISO 95+ GL ISO 95+ GL (Taper) RESISTA Insulation (Bottom Layer): 1.5"-4" thick, 4'x4' boards ISO 95+ GL ISO 95+ GL (Taper) RESISTA	Adhered at 12" o.c.: ISO Twin Pack	.045 mil. min. RubberGard MAX .045 mil. RubberGard MAX PT	BA-2004 Single-Ply LVOC Single-Ply LVOC 1168 WBBA-P	99640-0-0

Re-Roof - EPDM MAX/MAX FR (Adhered) – Gypsum Deck – ISO/Cover Board (Adhered) (Continued)

1-90 IF: 1 EF: A Slope: 4"	Gypsum	Cover Board: ½", 4'x4' boards DensDeck Securock Insulation (Top Layer): 1.5"-8" thick, 4'x4' boards ISO 95+ GL ISO 95+ GL (Taper) RESISTA Insulation (Bottom Layer): 1.5"-4" thick, 4'x4' boards ISO 95+ GL ISO 95+ GL (Taper) RESISTA	Adhered at 12" o.c.: ISO Twin Pack	.045 mil. min. RubberGard MAX FR	BA-2004 Single-Ply LVOC Single-Ply LVOC 1168	110304-0-0
1-90 IF: 1 EF: A Slope: ¼"	Gypsum	Cover Board: ½", 4'x4' boards ISOGARD HD 1"-2.5", 4'x4' boards ISOGARD HD Composite Insulation: 1.5"-4" thick, 4'x4' boards ISO 95+ GL ISO 95+ GL (Taper) RESISTA	Adhered at 12" o.c.: ISO Twin Pack ISO Stick/Twin Jet	.045 mil. min. RubberGard MAX .045 mil. RubberGard MAX PT .045 mil. min. RubberGard MAX FR	BA-2004 Single-Ply LVOC Single-Ply LVOC 1168 WBBA-P	262899-0-0

EPDM Platinum (Adhered) – Concrete Deck – V-Force – ISO (Adhered)

Uplift	Deck	Insulation	I Attachment	Membrane	M Attachment	RoofNav
1-75 IF: NC EF: A Slope: ½"	Concrete Min. 2,500 psi Min. 2" thick	Insulation: 1.5"-36" thick, 4'x4' boards ISO 95+ GL/ISO 95+ GL (Taper) RESISTA Vapor Barrier: V-Force (Self Adhered)	Adhered at 12" o.c.: ISO Spray R	.090 mil. RubberGard Platinum	BA-2004 Single-Ply LVOC Single-Ply LVOC 1168 WBBA-P	371174-0-0
				.090 mil. RubberGard Platinum PT	SFBA	384176-0-0
1-75 IF: NC EF: A Slope: ¼"	Concrete Min. 2,500 psi Min. 2" thick	Cover Board: ½", 4'x4' boards, ISOGARD HD 1"-2.5", 4'x4' boards, ISOGARD HD COMPOSITE Insulation: 1.5"-36" thick, 4'x4' boards ISO 95+ GL/ISO 95+ GL (Taper) Resista Vapor Barrier: V-Force (Self Adhered)	Adhered at 12" o.c.: ISO Spray R	.090 mil. RubberGard Platinum .090 mil. RubberGard Platinum PT	BA-2004 SFBA Single-Ply LVOC Single-Ply LVOC 1168 WBBA-P	371151-0-0
1-90 IF: NC EF: A Slope: ½"	Concrete Min. 2,500 psi Min. 2" thick	Insulation: 1.5"-36" thick, 4'x4' boards ISO 95+ GL/ISO 95+ GL (Taper) RESISTA Vapor Barrier: V-Force (Self-Adhered)	Adhered at 12" o.c.: ISO Spray R	.090 mil. RubberGard Platinum	BA-2004 Single-Ply LVOC Single-Ply LVOC 1168 WBBA-P	370560-0-0
				.090 mil. RubberGard Platinum PT	SFBA	384154-0-0
1-255 IF: NC EF: A Slope: ½"	Concrete Min. 2,500 psi Min. 2" thick	Cover Board: .438"-.5" APA Rated OSB Insulation: 1.5"-36" thick, 4'x4' boards ISO 95+ GL/ISO 95+ GL (Taper) RESISTA	Adhered at 12" o.c.: ISO Spray R	.090 mil. RubberGard Platinum .090 mil. RubberGard Platinum PT	BA-2004 EPDM SFBA Single-Ply LVOC Single-Ply LVOC 1168	308435-0-0
1-315 IF: NC EF: A Slope: ½"	Concrete Min. 2,500 psi Min. 2" thick	Insulation: 1.5"-36" thick, 4'x4' boards ISO 95+ GL/ISO 95+ GL (Taper)	Adhered at 12" o.c.: ISO Twin Pack	.090 mil. RubberGard Platinum .090 mil. RubberGard Platinum PT	BA-2004 Single-Ply LVOC Single-Ply LVOC 1168	102219-0-0

EPDM Platinum (Adhered) – Concrete Deck – V-Force – ISO (Adhered) (Continued)

1-465 IF: NC EF: A Slope: 2"	Concrete Min. 2,500 psi Min. 2" thick	Cover Board: ½", 4'x4' boards DensDeck DensDeck Prime Securock Insulation: 1.5"-36" thick, 4'x4' boards ISO 95+ GL ISO 95+ GL (Taper)	Adhered at 12" o.c.: ISO Stick/Twin Jet Primed Deck: Concrete Primer, Asphaltic Permeable	.090 mil. RubberGard Platinum .090 mil. RubberGard Platinum PT	BA-2004 Single-Ply LVOC	228432-0-0
1-465 IF: NC EF: A Slope: 3"	Concrete Min. 2,500 psi Min. 2" thick	Insulation: ½", 4'x4' boards DensDeck Securock	Adhered at 12" o.c.: ISO Twin Pack	.090 mil. RubberGard Platinum .090 mil. RubberGard Platinum PT	BA-2004 Single-Ply LVOC Single-Ply LVOC 1168	127083-0-0
1-525 IF: NC EF: A Slope: ½"	Concrete Min. 2,500 psi Min. 2" thick	Insulation: 1.5"-36" thick, 4'x4' boards ISO 95+ GL ISO 95+ GL (Taper) Vapor Barrier: V-Force (Self-Adhered) Primer (permeable) : SA-LVOC SA-SB V-Force SB	Adhered at 12" o.c.: ISO Spray R ISO Twin Pack ISO Stick/Twin Jet	.090 mil. RubberGard Platinum .090 mil. RubberGard Platinum PT	BA-2004 Single-Ply LVOC Single-Ply LVOC 1168	297178-0-0
1-525 IF: NC EF: A Slope: ½"	Concrete Min. 2,500 psi Min. 2" thick	Cover Board: ½", 4'x4' boards, ISOGARD HD 1"-2.5", 4'x4' boards, ISOGARD HD COMPOSITE Insulation: 1.5"-36" thick, 4'x4' boards ISO 95+ GL ISO 95+ GL (Taper) Vapor Barrier: V-Force (Self-Adhered) Primer (permeable): SA-LVOC SA-SB V-Force SB	Adhered at 12" o.c.: ISO Spray R ISO Twin Pack ISO Stick/Twin Jet	.090 mil. RubberGard Platinum .090 mil. RubberGard Platinum PT	BA-2004 SFBA Single-Ply LVOC WBBA-P	298272-0-0
1-525 IF: NC EF: A Slope: ½"	Concrete Min. 2,500 psi Min. 2" thick	Cover Board: ½", 4'x4' boards DensDeck DensDeck Prime Securock Insulation: 1.5"-36" thick, 4'x4' boards ISO 95+ GL/ISO 95+ GL (Taper) Vapor Barrier: V-Force (Self-Adhered) Primer (permeable): SA-LVOC SA-SB V-Force SB	Adhered at 12" o.c.: ISO Spray R ISO Twin Pack ISO Stick/Twin Jet	.090 mil. RubberGard Platinum .090 mil. RubberGard Platinum PT	BA-2004 Single-Ply LVOC	297159-0-0
1-540 IF: NC EF: A Slope: ½"	Concrete Min. 2,500 psi Min. 2" thick	Insulation: 1.5"-36" thick, 4'x4' boards ISO 95+ GL ISO 95+ GL (Taper)	Adhered at 12" o.c.: ISO Stick/Twin Jet Primed Deck: Concrete Primer, Asphaltic Permeable	.090 mil. RubberGard Platinum .090 mil. RubberGard Platinum PT	BA-2004 Single-Ply LVOC	228465-0-0
1-555 IF: NC EF: A Slope: ½"	Concrete Min. 2,500 psi Min. 2" thick	Cover Board: ½", 4'x4' boards ISOGARD HD 1"-2.5", 4'x4' boards ISOGARD HD Composite Insulation: 1"-36" thick, 4'x4' boards ISO 95+ GL/ISO 95+ GL (Taper)	Adhered at 12" o.c.: ISO Spray R	.090 mil. RubberGard Platinum .090 mil. RubberGard Platinum PT	BA-2004 EPDM SFBA Single-Ply LVOC Single-Ply LVOC 1168 WBBA-P	308236-0-0

EPDM Platinum (Adhered) – Concrete Deck – V-Force – ISO (Adhered) (Continued)

1-675 IF: NC EF: A Slope: ½"	Concrete Min. 2,500 psi Min. 2" thick	Insulation: 1.5"-36" thick, 4'x4' boards ISO 95+ GL ISO 95+ GL (Taper) Vapor Barrier: V-Force (Self-Adhered) Primer (permeable): SA-LVOC SA-SB V-Force SB	Adhered at 12" o.c.: ISO Spray R ISO Twin Pack ISO Stick/Twin Jet	.090 mil. RubberGard Platinum .090 mil. RubberGard Platinum PT	BA-2004 Single-Ply LVOC	296334-0-0
1-690 IF: NC EF: A Slope: 3"	Concrete Min. 2,500 psi Min. 2" thick	Cover Board: ¼", 4'x4' boards DensDeck Securock Insulation: 1.5"-36" thick, 4'x4' boards ISO 95+ GL ISO 95+ GL (Taper)	Full Spray.: ISO Spray R 1.04 gal/square	.090 mil. RubberGard Platinum .090 mil. RubberGard Platinum PT	BA-2004 Single-Ply LVOC	126897-0-0
1-690 IF: NC EF: A Slope: 1"	Concrete Min. 2,500 psi Min. 2" thick	Cover Board: ¼", 4'x4' boards DensDeck Securock Insulation: 1.5"-36" thick, 4'x4' boards ISO 95+ GL ISO 95+ GL (Taper)	Full Spray: ISO Spray R 1.04 gal/square	.090 mil. RubberGard Platinum .090 mil. RubberGard Platinum PT	BA-2004 Single-Ply LVOC	62382-0-0

Re-Roof – EPDM Platinum (Adhered) – Gypsum Deck – ISO/Cover Board (Adhered)

Uplift	Deck	Cover Board / Insulation	C/I Attachment	Membrane	M Attachment	RoofNav
1-90 IF: 1 EF: A Slope: 3"	Gypsum	Cover Board: ¼", 4'x4' boards DensDeck/Securock	Adhered at 12" o.c.: ISO Twin Pack	.090 mil. RubberGard Platinum .090 mil. RubberGard Platinum PT	BA-2004 Single-Ply LVOC Single-Ply LVOC 1168 WBBA-P	127015-0-0
1-90 IF: 1 EF: A Slope: 3"	Gypsum	Cover Board: ¼", 4'x4' boards DensDeck/Securock Insulation (Top Layer): 1.5"-8" thick, 4'x4' boards ISO 95+ GL Flat/Taper) RESISTA Insulation (Bottom Layer): 1.5"-4" thick, 4'x4' boards ISO 95+ GL Flat/Taper) RESISTA	Adhered at 12" o.c.: ISO Twin Pack	.090 mil. RubberGard Platinum .090 mil. RubberGard Platinum PT	BA-2004 Single-Ply LVOC Single-Ply LVOC 1168 WBBA-P	127014-0-0
1-90 IF: 1 EF: A Slope: ¼"	Gypsum	Cover Board: ½", 4'x4' boards ISOGARD HD 1"-2.5", 4'x4' boards ISOGARD HD Composite Insulation: 1.5"-4" thick, 4'x4' boards ISO 95+ GL (Flat/Taper) RESISTA	Adhered at 12" o.c.: ISO Twin Pack ISO Stick/Twin Jet	.090 mil. RubberGard Platinum .090 mil. RubberGard Platinum PT	BA-2004 Single-Ply LVOC Single-Ply LVOC 1168 WBBA-P	262899-0-0
1-90 IF: 1 EF: A Slope: ½"	Gypsum	Cover Board: ½", 4'x4' boards ISOGARD HD 1"-8", 4'x4' boards ISOGARD HD Composite Insulation: 1.5"-4" thick, 4'x4' boards ISO 95+ GL Flat/Taper) RESISTA	Adhered at 12" o.c.: ISO Spray R ISO Twin Pack ISO Stick/Twin Jet	.090 mil. RubberGard Platinum .090 mil. RubberGard Platinum PT	BA-2004 Single-Ply LVOC Single-Ply LVOC 1168 WBBA-P	420488-0-0

EcoWhite EPDM (Adhered) – Concrete Deck – V-Force – ISO/Cover Board (Adhered)

Uplift	Deck	Cover Board / Insulation	C/I Attachment	Membrane	M Attachment	RoofNav
1-450 IF: NC EF: A Slope: 1/2"	Concrete Min. 2,500 psi Min. 2" thick	Cover Board: 1/2", 4'x4' boards, ISOGARD HD 1"-2.5", 4'x4' boards, ISOGARD HD COMPOSITE Insulation: 4'x4' boards (Top) 1/2" - 4" thick Taper Taper or Flat ISO 95+ GL (2nd) 1.5"-4" thick (3rd) 1.5"-4" thick (Bottom) 1.5"-36" thick Vapor Barrier: V-Force (Self-Adhered) Primer (permeable): SA-LVOC SA-SB V-Force SB	Adhered at 12" o.c.: ISO Spray R ISO Twin Pack ISO Stick/Twin Jet	.060 RubberGard EcoWhite	Single-Ply LVOC 1168	306708-0-0
1-465 IF: NC EF: A Slope: 1.5"	Concrete Min. 2,500 psi Min. 2" thick	Cover Board: 1/4", 4'x4' boards DensDeck, DensDeck Prime Securock Insulation: 1.5"-36" thick, 4'x4' boards ISO 95+ GL Flat/Taper)	Adhered at 12" o.c.: ISO Stick/Twin Jet	.060 RubberGard EcoWhite	BA-2004 Single-Ply LVOC	231125-0-0
1-495 IF: NC EF: A Slope: 1"	Concrete Min. 2,500 psi Min. 2" thick	Cover Board: .438"-.5" APA Rated OSB Insulation: 1.5"-36" thick, 4'x4' boards ISO 95+ GL Flat/Taper)	Adhered at 12" o.c.: ISO Stick/Twin Jet	.060 RubberGard EcoWhite	BA-2004 EPDM - SFBA Single-Ply LVOC Single-Ply LVOC 1168	231121-0-0
1-525 IF: NC EF: A Slope: 1/2"	Concrete Min. 2,500 psi Min. 2" thick	Insulation: 1.5"-36" thick, 4'x4' boards ISO 95+ GL Flat/Taper) Vapor Barrier: V-Force (Self-Adhered) Primer (permeable): SA-LVOC SA-SB V-Force SB	Adhered at 12" o.c.: ISO Spray R ISO Twin Pack ISO Stick/Twin Jet	.060 RubberGard EcoWhite	BA-2004 Single-Ply LVOC Single-Ply LVOC 1168	297191-0-0
1-525 IF: NC EF: A Slope: 1/2"	Concrete Min. 2,500 psi Min. 2" thick	Cover Board: 1/2", 4'x4' boards, ISOGARD HD 1"-2.5", 4'x4' boards, ISOGARD HD COMPOSITE Insulation: 1.5"-36" thick, 4'x4' boards ISO 95+ GL Flat/Taper) Vapor Barrier: V-Force (Self-Adhered) Primer (permeable): SA-LVOC SA-SB V-Force SB	Adhered at 12" o.c.: ISO Spray R ISO Twin Pack ISO Stick/Twin Jet	.060 RubberGard EcoWhite	BA-2004 SFBA Single-Ply LVOC WBBA-P	298280-0-0
1-525 IF: NC EF: A Slope: 1.5"	Concrete Min. 2,500 psi Min. 2" thick	Cover Board: 1/4", 4'x4' boards DensDeck, DensDeck Prime Securock Insulation: 1.5"-36" thick, 4'x4' boards ISO 95+ GL Flat/Taper) Vapor Barrier: V-Force (Self-Adhered) Primer (permeable): SA-LVOC SA-SB V-Force SB	Adhered at 12" o.c.: ISO Spray R ISO Twin Pack ISO Stick/Twin Jet	.060 RubberGard EcoWhite	BA-2004 Single-Ply LVOC	297197-0-0

EcoWhite EPDM (Adhered) – Concrete Deck – V-Force – ISO/Cover Board (Adhered) (Continued)

1-540 IF: NC EF: A Slope: 1/2"	Concrete Min. 2,500 psi Min. 2" thick	Insulation: 1.5"-36" thick, 4'x4' ISO 95+ GL ISO 95+ GL (Taper)	Adhered at 12" o.c.: ISO Stick/Twin Jet	.060 RubberGard EcoWhite	BA-2004 Single-Ply LVOC	231127-0-0
1-555 IF: NC EF: A Slope: 1/2"	Min. 2,500 psi Min. 2" thick	Cover Board: 1/2", 4'x4' boards, ISOGARD HD 1"-2.5", 4'x4' boards, ISOGARD HD COMPOSITE Insulation: 1.5"-36" thick, 4'x4' boards ISO 95+ GL ISO 95+ GL (Taper) RESISTA	Adhered at 12" o.c.: ISO Spray R	.060 RubberGard EcoWhite	BA-2004 EPDM - SFBA Single-Ply LVOC Single-Ply LVOC 1168 WBBA-P	308243-0-0
1-675 IF: NC EF: A Slope: 1/2"	Concrete Min. 2,500 psi Min. 2" thick	Insulation: 1.5"-36" thick, 4'x4' boards ISO 95+ GL ISO 95+ GL (Taper) RESISTA Vapor Barrier: V-Force (Self-Adhered) Primer (permeable): SA-LVOC SA-SB V-Force SB	Adhered at 12" o.c.: ISO Spray R ISO Twin Pack ISO Stick/Twin Jet	.060 RubberGard EcoWhite	BA-2004 Single-Ply LVOC	296358-0-0

Re-Cover – EcoWhite EPDM (Adhered) – Treated Wood Deck – ISO/Cover Board (Attached)

Uplift	Deck	Cover Board / Insulation	C/I Attachment	Membrane	M Attachment	RoofNav
1-90 IF: 1 EF: A Slope: 1/2"	Treated Wood	Cover Board: 1/2" ISOGARD HD Insulation: 1.5"-12" ISO 95+ GL Thermal Barrier: 1/4" min. DensDeck or DensDeck Prime	Cover Board: 12 All-Purpose or Heavy Duty Fasteners/Plates per 4'x8' board Insulation: CF Thermal Barrier: CF	.060 mil. min. RubberGard EcoWhite	BA-2004 Single-Ply LVOC	398080-0-0

Re-Roof – EcoWhite EPDM (Adhered) – Gypsum Deck – ISO/Cover Board (Adhered)

Uplift	Deck	Cover Board / Insulation	C/I Attachment	Membrane	M Attachment	RoofNav
1-90 IF: 1 EF: A Slope: 1.5"	Gypsum	Insulation: 1/4", 4'x4' boards DensDeck DensDeck Prime Securock	Adhered at 12" o.c.: ISO Twin Pack	.060 RubberGard EcoWhite .060 EcoWhite PT	BA-2004 Single-Ply LVOC	256108-0-0
1-90 IF: 1 EF: A Slope: 1/2"	Gypsum	Insulation: 1/2", 4'x4' boards ISOGARD HD	Adhered at 12" o.c.: ISO Twin Pack	.060 RubberGard EcoWhite .060 EcoWhite PT	BA-2004 Single-Ply LVOC Single-Ply LVOC 1168	256002-0-0
1-90 IF: 1 EF: A Slope: 1.5"	Gypsum	Insulation: 1/4", 4'x4' boards DensDeck DensDeck Prime Securock	Adhered at 12" o.c.: ISO Twin Pack	.060 RubberGard EcoWhite .060 EcoWhite PT	BA-2004 Single-Ply LVOC	256108-0-0

Re-Roof – EcoWhite EPDM (Adhered) – Gypsum Deck – ISO/Cover Board (Adhered) (Continued)

1-90 IF: 1 EF: A Slope: 1/2"	Gypsum	Cover Board: 1/2", 4'x4' boards ISOGARD HD 1"-2.5", 4'x4' boards ISOGARD HD Insulation (Top Layer): 1.5"-4" thick, 4'x4' boards ISO 95+ GL (Flat/Taper) RESISTA Insulation (Bottom Layer): 1.5"-8" thick, 4'x4' boards ISO 95+ GL (Flat/Taper) RESISTA	Adhered at 12" o.c.: ISO Twin Pack ISO Stick/Twin Jet	.060 RubberGard EcoWhite .060 EcoWhite PT	BA-2004 Single-Ply LVOC Single-Ply LVOC 1168 WBBA-P	262840-0-0
1-90 IF: 1 EF: A Slope: 1/2"	Gypsum	Insulation (Top Layer): 1.5"-4" thick, 4'x4' boards ISO 95+ GL ISO 95+ GL (Taper) RESISTA Insulation (Bottom Layer): 1.5"-8" thick, 4'x4' boards ISO 95+ GL (Flat/Taper) RESISTA	Adhered at 12" o.c.: ISO Twin Pack ISO Stick/Twin Jet	.060 RubberGard EcoWhite .060 EcoWhite PT	BA-2004 Single-Ply LVOC Single-Ply LVOC 1168 WBBA-P	262871-0-0

EcoWhite EPDM (Adhered) – Concrete Deck – ISO/Cover Board (Attached)

Uplift	Deck	Cover Board / Insulation	C/I Attachment	Membrane	M Attachment	RoofNav
1-90 IF: NC EF: A Slope: 1/2"	Concrete Min. 2,500 psi Min. 2" thick	Insulation: 2"-12" thick, 4'x4' boards ISO 95+ GL ISO 95+ GL (Taper) RESISTA Vapor Barrier (Optional): V-Force (Self-Adhered) Primer SBS Torch	Insulation: 8 Heavy-Duty or Concrete Drive Fasteners/Plates per 4'x8' board	.045 mil. min. RubberGard LS-FR .060 mil. RubberGard LS-FR PT	BA-2004 Single-Ply LVOC Single-Ply LVOC 1168 WBBA - P	32595-0-0

EPDM LS-FR/SA (Adhered) – Steel Deck – ISO/Cover Board (Attached)

Uplift	Deck	Cover Board / Insulation	C/I Attachment	Membrane	M Attachment	RoofNav
1-60 IF: 1 EF: A Slope: 1/2"	Steel 16-22 ga 33 ksi 72" span	Insulation: 1.5"-12" ISO 95+ GL ISO 95+ GL (Taper) RESISTA Optional: 4 or 6 mil Poly. V-Force (Self-Adhered) DensDeck	Insulation: 10 Heavy-Duty Fasteners/Plates per 4'x8' board Optional: Self-Adhered Loose Laid	.045 mil. min. RubberGard LS-FR .060 mil. RubberGard LS-FR PT	BA-2004 Single-Ply LVOC Single-Ply LVOC 1168 WBBA - P	32579-0-0
1-90 IF: 1 EF: A Slope: 1/2"	Steel 16-22 ga 33 ksi 72" span	Insulation: 1.5"-12" ISO 95+ GL ISO 95+ GL (Taper) RESISTA Optional: 4 or 6 mil Poly. V-Force (Self-Adhered) DensDeck	Insulation: 12 Heavy-Duty Fasteners/Plates per 4'x8' board Optional: Self-Adhered Loose Laid	.045 mil. min. RubberGard LS-FR .060 mil. RubberGard LS-FR PT	BA-2004 Single-Ply LVOC Single-Ply LVOC 1168 WBBA - P	32578-0-0
1-120 IF: 1 EF: A Slope: 1/2"	Steel 18-22 ga Wide Rib 33 ksi 72" span	Insulation: 1.5"-12" ISO 95+ GL ISO 95+ GL (Taper) Optional: 4 or 6 mil Poly. V-Force (Self-Adhered) DensDeck	Insulation: 19 Heavy-Duty Fasteners/Plates per 4'x8' board Optional: Self-Adhered Loose Laid	.045 mil. min. RubberGard LS-FR .060 mil. RubberGard LS-FR PT	BA-2004 Single-Ply LVOC Single-Ply LVOC 1168	234811-0-0

EPDM LS-FR/SA (Adhered) – Steel Deck – ISO/Cover Board (Attached) (Continued)

1-165 IF: 1 EF: A Slope: 1/2"	Steel 18-22 ga Wide Rib 33 ksi 724'x8' span	Insulation: 1.5" -12" ISO 95+ GL ISO 95+ GL (Taper) Optional: 4 or 6 mil Poly. V-Force (Self-Adhered) DensDeck	Insulation: 24 Heavy-Duty Fasteners/Plates per 4'x8' board Optional: Self-Adhered Loose Laid	.045 mil. min. RubberGard LS-FR .060 mil. RubberGard LS-FR PT	BA-2004 Single-Ply LVOC 1168	232549-0-0
1-90 IF: 1 EF: A Slope: 1/2"	Steel 16-22 ga 33 ksi 72" span	Insulation: 2" -12" ISO 95+ GL ISO 95+ GL (Taper) RESISTA Optional: 4 or 6 mil Poly. V-Force (Self-Adhered) DensDeck	Insulation: 8 Heavy-Duty Fasteners/Plates per 4'x8' board Optional: Self-Adhered Loose Laid	.045 mil. min. RubberGard LS-FR .060 mil. RubberGard LS-FR PT	BA-2004 Single-Ply LVOC Single-Ply LVOC 1168 WBBA-P	32581-0-0
1-165 IF: 1 EF: A Slope: 1/2"	Steel 18-22 ga Wide Rib 33 ksi 72" span	Insulation: 2" -12" ISO 95+ GL ISO 95+ GL (Taper) RESISTA Optional: 4 or 6 mil Poly. V-Force (Self-Adhered) DensDeck	Insulation: 20 Heavy-Duty Fasteners/Plates per 4'x8' board Optional: Self-Adhered Loose Laid	.045 mil. min. RubberGard LS-FR .060 mil. RubberGard LS-FR PT	BA-2004 Single-Ply LVOC Single-Ply LVOC 1168	232557-0-0
1-225 IF: 1 EF: A Slope: 1/2"	Steel 22 ga Wide Rib 33 ksi 62" span 18-22 ga Wide Rib 80 ksi 72" span	Insulation: 2" -12" ISO 95+ GL ISO 95+ GL (Taper) RESISTA Optional: 4 or 6 mil Poly. V-Force (Self-Adhered) DensDeck	Insulation: 32 Heavy-Duty Fasteners/Plates per 4'x8' board Optional: Self-Adhered Loose Laid	.045 mil. min. RubberGard LS-FR .060 mil. RubberGard LS-FR PT	BA-2004 Single-Ply LVOC Single-Ply LVOC 1168	228247-0-0
1-90 IF: 1 EF: A Slope: 1"	Steel 16-22 ga 33 ksi 72" span	Insulation: 1.5" -12", 4' x4' boards ISO 95+ GL Resista Tapered Available Vapor Barrier: V-Force (Self-Adhered) Thermal Barrier: 1/4" DensDeck	Insulation: 12" o.c. Beads ISO Spray R, ISO Twin Pack ISO Stick Vapor Barrier: Self-Adhered w/ Primer Thermal Barrier: 8 Heavy-Duty Fasteners/Plates per 4'x8' board	Coating: AcryliTop PC-100 Membrane: .045 mil. min. RubberGard LS-FR .060 mil. RubberGard LS-FR PT	BA-2004 Single-Ply LVOC Single-Ply LVOC 1168 WBBA-P	293919-0-0
1-90 IF: 1 EF: A Slope: 1/2"	Steel 16-22 ga 33 ksi 72" span	Cover Board: 1/2" ISO GARD HD Insulation: 1.5" -12" ISO 95+ GL ISO 95+ GL (Taper) RESISTA Optional: 4 or 6 mil Poly. V-Force (Self-Adhered) DensDeck	Cover Board: 12 Heavy-Duty Fasteners/Plates per 4'x8' board Insulation: Loose Laid Optional: Self-Adhered Loose Laid	.045 mil. min. RubberGard LS-FR .060 mil. RubberGard LS-FR PT	BA-2004 SFBA Single-Ply LVOC Single-Ply LVOC 1168	285091-0-0
1-90 IF: 1 EF: A Slope: 1"	Steel 16-22 ga 33 ksi 72" span	Cover Board: 1/2" min. DensDeck, Securock Insulation (Optional): 1.5" -12" ISO 95+ GL ISO 95+ GL (Taper) Optional: 4 or 6 mil Poly. V-Force (Self-Adhered) DensDeck	Cover Board: 16 Heavy-Duty Fasteners/Plates per 4'x8' board Insulation (Optional): Loose Laid Optional: Self-Adhered Loose Laid	.045 mil. min. RubberGard LS-FR .060 mil. RubberGard LS-FR PT	BA-2004 Single-Ply LVOC Single-Ply LVOC 1168 WBBA-P	34485-0-0

EPDM LS-FR/SA (Adhered) – Steel Deck – ISO/Cover Board (Attached) (Continued)

1-150 IF: 1 EF: A Slope: 1"	Steel 18-22 ga Wide Rib 33 ksi 72" span	Cover Board: ½" min. DensDeck, Securock Insulation (Optional): 1.5"-12" ISO 95+ GL ISO 95+ GL (Taper) RESISTA Optional: 4 or 6 mil Poly. V-Force (Self-Adhered) DensDeck	Cover Board: 24 Heavy-Duty Fasteners/Plates per 4'x8' board Insulation (Optional): Loose Laid Optional: Self-Adhered Loose Laid	.045 mil. min. RubberGard LS-FR .060 mil. RubberGard LS-FR PT .045 mil RubberGard EPDM SA	BA-2004 Single-Ply LVOC Single-Ply LVOC 1168 Self-Adhered	200396-0-0
1-210 IF: 1 EF: A Slope: 1"	Steel-WR 18-20 ga 33 ksi 72" span 22 ga 33 ksi 64" span 18-22 ga 80 ksi 72" span	Cover Board: ½" min. DensDeck, Securock Insulation (Optional): 1.5"-12" ISO 95+ GL ISO 95+ GL (Taper) RESISTA Optional: 4 or 6 mil Poly. V-Force (Self-Adhered) DensDeck	Cover Board: 32 Heavy-Duty Fasteners/Plates per 4'x8' board Insulation (Optional): Loose Laid Optional: Self-Adhered Loose Laid	.045 mil. min. RubberGard LS-FR .060 mil. RubberGard LS-FR PT .045 mil RubberGard EPDM SA	BA-2004 Single-Ply LVOC Single-Ply LVOC 1168 Self-Adhered	200397-0-0
1-90 IF: 1 EF: A Slope: 1"	Steel 18-20 ga 33 ksi 72" span	Insulation: 2"-4" HAILGARD Optional: 4 or 6 mil. Poly. V-Force (Self-Adhered) DensDeck	Insulation: 13 HD HAILGARD Fasteners per 4'x8' board	.045 mil. min. RubberGard LS-FR .060 mil. RubberGard LS-FR PT .045 mil. RubberGard EPDM SA	BA-2004 SFBA Single-Ply LVOC Single-Ply LVOC 1168 Self-Adhered	136340-0-0
1-150 IF: 1 EF: A Slope: 1"	Steel - WR 18-22 ga 33 ksi 72" span	Cover Board: 2"-4" HAILGARD Insulation: 1.5"-12" ISO 95+ GL ISO 95+ GL (Taper) Optional: 4 or 6 mil Poly. V-Force (Self-Adhered) DensDeck	Cover Board: 16 Heavy Duty Fasteners/Plates per 4'x8' board Insulation (Optional): Loose Laid Optional: Self-Adhered Loose Laid	.045 mil. min. RubberGard LS-FR .060 mil. RubberGard LS-FR PT .045 mil RubberGard EPDM SA	BA-2004 Single-Ply LVOC Single-Ply LVOC 1168 Self-Adhered	286011-0-0
1-300 IF: 1 EF: A Slope: 1"	Steel - WR 18ga/33ksi/ 70" span 20ga/33ksi /60" span 22ga/33ksi /54" span 22- 18ga/80ksi /72" span	Insulation: 2"-4" HAILGARD Optional: 4 or 6 mil Poly. V-Force (Self-Adhered) DensDeck	Insulation: 32 Heavy Duty Fasteners/Plates per 4'x8' board Optional: Self-Adhered Loose Laid	.045 mil. min. RubberGard LS-FR .060 mil. RubberGard LS-FR PT	BA-2004	213482-0-0
1-90 IF: 1 EF: A Slope: 1"	Steel 22-16 ga 33 ksi 72" span	Cover Board: APA Rated OSB Min. 0.438" Max. 0.50" Insulation: 1.5"-12" ISO 95+ GL ISO 95+ GL (Taper) RESISTA Optional: 4 or 6 mil Poly. V-Force (Self-Adhered) DensDeck	Cover Board: 16 Heavy Duty Fasteners/Plates per 4'x8' board Insulation (Optional): Loose Laid Optional: Self-Adhered Loose Laid	.045 mil. min. RubberGard LS-FR .060 mil. RubberGard LS-FR PT .045 mil RubberGard EPDM SA	BA-2004 SFBA Single-Ply LVOC Single-Ply LVOC 1168 WBBA-P Self-Adhered	34524-0-0

EPDM LS-FR/SA (Adhered) – Steel Deck – ISO/Cover Board (Attached) (Continued)

1-150 IF: 1 EF: A Slope: 1"	Steel - WR 22-18 ga 33 ksi 72" span	Cover Board: APA Rated OSB Min. 0.438" Max. 0.50" Insulation: 1.5"-12" ISO 95+ GL ISO 95+ GL (Taper) Optional: 4 or 6 mil Poly. V-Force (Self-Adhered) DensDeck	Cover Board: 16 Heavy Duty Fasteners/Plates per 4'x8' board Insulation (Optional): Loose Laid Optional: Self-Adhered Loose Laid	.045 mil. min. RubberGard LS-FR .060 mil. RubberGard LS-FR PT .045 mil RubberGard EPDM SA	BA-2004 Single-Ply LVOC Single-Ply LVOC 1168 Self-Adhered	77824-0-0
1-300 IF: 1 EF: A Slope: 1"	Steel - WR 18ga/33ksi/ 70" span 20ga/33ksi /60" span 22ga/33ksi /54" span 22- 18ga/80ksi /72" span	Cover Board: APA Rated OSB Min. 0.438" Max. 0.50" Insulation: 1.5"-12" ISO 95+ GL ISO 95+ GL (Taper) Optional: 4 or 6 mil Poly. V-Force (Self-Adhered) DensDeck	Cover Board: 32 Heavy Duty Fasteners/Plates per 4'x8' board Insulation (Optional): Loose Laid Optional: Self-Adhered Loose Laid	.045 mil. min. RubberGard LS-FR .060 mil. RubberGard LS-FR PT .045 mil RubberGard EPDM SA	BA-2004 Single-Ply LVOC Single-Ply LVOC 1168 Self-Adhered	213475-0-0

RubberGard EPDM SA (Adhered) – Concrete Deck – ISO/Cover Board (Adhered)

Concrete Deck – Minimum 2,500 psi – Minimum 2" thick

Uplift	Cover Board / Insulation		C/I Attachment	Membrane	RoofNav
90 PSF IF: NC EF: A Slope: 1" Hail: SH	Cover Board: 1/4" - 5/8" thick DensDeck Prime/ 1/2" min. Securock Insulation (Top): 1" - 12" thick ISO 95+ GL (F/T) Resista (F/T)		Cover Board: 12 Fasteners/Plates per board Concrete Drive Heavy-Duty Insulation: CF	Coating (Optional): AcryliTop PC-100 Coat Membrane: RubberGard EPDM SA	265629-0-0
90 PSF IF: NC EF: A Slope: 1" Hail: SH	Insulation: 1" - 12" thick ISO 95+ GL/Resista (F/T)	Cover Board: 1/2" - 5/8" thick Securock	Cover Board: 12 Fasteners/Plates per board Concrete Drive Heavy-Duty Insulation: CF	Coating (Optional): AcryliTop PC-100 Coat Membrane: RubberGard EPDM SA	401632-0-0
	1.5" - 12" thick ISO 95+ GL/Resista (F/T)	1/4" thick Securock	Cover Board: 10 Fasteners/Plates per board Concrete Drive Heavy-Duty Insulation: CF		401655-0-0
	1.5" - 12" thick ISO 95+ GL/Resista (F/T)	3/8" - 5/8" thick Securock	Cover Board: 8 Fasteners/Plates per board Concrete Drive Heavy-Duty Insulation: CF		401656-0-0

RubberGard EPDM SA (Adhered) – Concrete Deck – ISO/Cover Board (Adhered) (Continued)

90 PSF IF: NC EF: A Slope: 1" Hail: SH	Cover Board: 1/2" - 5/8" thick Securock Insulation: 1.5" - 12" thick ISO 95+ GL/Resista (F/T) Vapor Barrier (Optional): 4 - 6 mil Poly V-Force w/ Primer	Cover Board: 8 Fasteners/Plates per board Concrete Drive Heavy-Duty Insulation: CF	Coating (Optional): AcryliTop PC-100 Coat Membrane: RubberGard EPDM SA	401927-0-0
105 PSF	Cover Board:	Cover Board:	Coating (Optional):	395804-0-0

IF: NC EF: A Slope: 1" Hail: SH	<p>1/4" - 5/8" thick DensDeck Prime</p> <p>Insulation: 1.5" - 12" thick ISO 95+ GL/Resista (F/T)</p> <p>Vapor Barrier (Optional): 4 - 6 mil Poly V-Force w/ Primer BaseGard SA w/ Primer</p>	<p>18 Fasteners/Plates per board Heavy-Duty</p> <p>Insulation: CF</p>	<p>AcryliTop PC-100 Coat</p> <p>Membrane: RubberGard EPDM SA</p>	
135 PSF IF: NC EF: A Slope: 1" Hail: SH	<p>Cover Board: 1/2" - 5/8" thick DensDeck Prime</p> <p>Insulation: 1.5" - 12" thick ISO 95+ GL/Resista (F/T)</p> <p>Vapor Barrier (Optional): 4 - 6 mil Poly V-Force w/ Primer</p>	<p>Cover Board: 18 Fasteners/Plates per board Heavy-Duty</p> <p>Insulation: CF</p>	<p>Coating (Optional): AcryliTop PC-100 Coat</p> <p>Membrane: RubberGard EPDM SA</p>	395805-0-0
150 PSF IF: NC EF: A Slope: 1" Hail: SH	<p>Cover Board: 1/2" - 5/8" thick DensDeck Prime</p> <p>Insulation: 1.5" - 12" thick ISO 95+ GL/Resista (F/T)</p> <p>Vapor Barrier (Optional): 4 - 6 mil Poly V-Force w/ Primer BaseGard AS w/ Primer</p>	<p>Cover Board: 20 Fasteners/Plates per board Heavy-Duty</p> <p>Insulation: CF</p>	<p>Coating (Optional): AcryliTop PC-100 Coat</p> <p>Membrane: RubberGard EPDM SA</p>	395806-0-0
1-225 IF: NC EF: A Slope: 1" Hail: SH	<p>Cover Board: Securock Min. 0.25" - Max. 0.625"</p> <p>Insulation: 1.5"-12" thick ISO 95+ GL (Flat/Taper) Resista</p> <p>Optional: 4 or 6 mil Poly. V-Force (Self-Adhered)/DensDeck</p>	<p>Cover Board: ISO Twin Pack; Adhered at 12" o.c.</p> <p>Insulation: ISO Twin Pack; Adhered at 12" o.c.</p>	<p>Coating (Optional): AcryliTop PC-100 Coat</p> <p>Membrane: RubberGard EPDM SA</p>	407862-0-0
1-225 IF: NC EF: A Slope: 1" Hail: SH	<p>Cover Board: Securock Min. 0.25" - Max. 0.625"</p> <p>Insulation: 1/2"-12" thick ISO 95+ GL (Flat/Taper) -or- 1"-12" thick Resista</p>	<p>Cover Board: ISO Stick Twin Jet; Adhered at 12" o.c.</p> <p>Insulation: ISO Stick Twin Jet; Adhered at 12" o.c.</p>	<p>Coating (Optional): AcryliTop PC-100 Coat</p> <p>Membrane: RubberGard EPDM SA</p>	412609-0-0
1-255 IF: NC EF: A Slope: 1" Hail: SH	<p>Cover Board: HailGard* Min. 1.5" - Max. 4.0" -or- OSB (APA Rated) Min. 7/16" - Max. 1/2"</p> <p>Insulation: 1/2"-12" thick ISO 95+ GL (Flat/Taper) -or- 1"-12" thick Resista</p>	<p>Cover Board: ISO Stick Twin Jet; Adhered at 12" o.c.</p> <p>Insulation: ISO Stick Twin Jet; Adhered at 12" o.c.</p>	<p>Coating (Optional): AcryliTop PC-100 Coat</p> <p>Membrane: RubberGard EPDM SA</p>	412587-0-0

RubberGard EPDM SA (Adhered) – Concrete Deck – ISO/Cover Board (Adhered) (Continued)

1-255 IF: NC EF: A Slope: 1" Hail: SH	<p>Cover Board: HailGard* Min. 1.5" - Max. 4.0" -or- OSB (APA Rated) Min. 7/16" - Max. 1/2"</p> <p>Insulation: 1/2"-12" thick ISO 95+ GL ISO 95+ GL (Taper) -or-</p>	<p>Cover Board: ISO Twin Pack Adhered at 12" o.c.</p> <p>Insulation: ISO Twin Pack Adhered at 12" o.c.</p>	<p>Coating (Optional): AcryliTop PC-100 Coat</p> <p>Membrane: RubberGard EPDM SA</p>	407840-0-0
---	--	--	--	------------

	1"-12" thick Resista			
1-255 IF: NC EF: A Slope: 1" Hail: SH	Cover Board: HailGard* Min. 1.5" - Max. 4.0" -or- OSB (APA Rated) Min. 7/16" - Max. 1/2" Insulation: 1"-36" thick ISO 95+ GL (Flat/Taper) Resista	Cover Board: ISO Spray R Adhered at 12" o.c. Insulation: ISO Spray R Adhered at 12" o.c.	Coating (Optional): AcryliTop PC-100 Coat Membrane: RubberGard EPDM SA	308441-0-0
1-255 IF: NC EF: A Slope: 1" Hail: SH	Cover Board: HailGard* Min. 1.5" - Max. 4.0" -or- OSB (APA Rated) Min. 7/16" - Max. 1/2" Insulation (Top): 1"-4" thick ISO 95+ GL Resista 1/2"-4" thick ISO 95+ GL (Taper) Resista Insulation (Bottom): 1"-36" thick ISO 95+ GL (Flat/Taper) Resista	Cover Board: ISO Spray R Adhered at 12" o.c. Insulation: ISO Spray R Adhered at 12" o.c.	Coating (Optional): AcryliTop PC-100 Coat Membrane: RubberGard EPDM SA	308505-0-0
1-300 IF: NC EF: A Slope: 1" Hail: SH	Cover Board: SECUROCK Min. 1/4" - Max. 5/8" Insulation: 1/2" - 36" thick ISO 95+ GL ISO 95+ GL (Taper)	Cover Board: ISO Stick/Twin Jet Adhered at 12" o.c. Insulation: ISO Stick/Twin Jet Adhered at 12" o.c.	Coating (Optional): AcryliTop PC-100 Coat Membrane: RubberGard EPDM SA	375124-0-0
1-315 IF: NC EF: A Slope: 1" Hail: SH	1/4" min. SECUROCK 1.5" - 36" ISO 95+ GL (F/T)	12" o.c. beads ISO Twin Pack	Coating (Optional): AcryliTop PC-100 Coat Membrane: RubberGard EPDM SA	375164-0-0
	1/4" min. DensDeck Prime/SECUROCK 1.5" - 36" ISO 95+ GL (F/T)	12" o.c. beads ISO Spray R/ISO Twin Pack		375168-0-0
	1.5" - 4" HailGard* or min. 7/16" OSB 1.5" - 36" ISO 95+ GL (F/T)	12" o.c. beads ISO Twin Pack		374161-0-0
	1/4" min. DensDeck Prime/SECUROCK 1/2" - 4" Tapered ISO 95+ GL (Top) 1.5" - 36" ISO 95+ GL (F/T) (Bottom)	12" o.c. beads ISO Spray R/ISO Twin Pack		409050-0-0
1-375 IF: NC EF: A Slope: 3/4" Hail: SH	Cover Board: 1/2" ISO GARD HD 1" - 2.5" ISO GARD HD Comp. Insulation: 1/2" - 12" thick ISO 95+ GL (F/T) 1" - 12" thick Resista (F/T)	Cover Board: ISO Stick/Twin Jet Adhered at 12" o.c. Insulation: ISO Stick/Twin Jet Adhered at 12" o.c.	Coating (Optional): AcryliTop PC-100 Coat Membrane: RubberGard EPDM SA	412582-0-0
1-375 IF: NC EF: A Slope: 1" Hail: SH	Cover Board: 1/4" - 5/8" thick DensDeck Prime Insulation: 1/2" - 12" thick ISO 95+ GL (F/T) 1" - 12" thick Resista (F/T)	Cover Board: ISO Stick/Twin Jet Adhered at 12" o.c. Insulation: ISO Stick/Twin Jet Adhered at 12" o.c.	Coating (Optional): AcryliTop PC-100 Coat Membrane: RubberGard EPDM SA	412608-0-0

RubberGard EPDM SA (Adhered) – Concrete Deck – ISO/Cover Board (Adhered) (Continued)

1-375 IF: NC EF: A Slope: 1" Hail: SH	Cover Board: 1/4" - 5/8" thick DensDeck Prime/Securock Insulation: 1.5" - 36" thick ISO 95+ GL (F/T)	Cover Board: ISO Stick/Twin Jet Adhered at 12" o.c. Insulation: ISO Stick/Twin Jet Adhered at 12" o.c.	Coating (Optional): AcryliTop PC-100 Coat Membrane: RubberGard EPDM SA	409034-0-0
1-465	Cover Board: 1/4" - 5/8" thick DensDeck Prime	Cover Board: ISO Twin Pack	Coating (Optional): AcryliTop PC-100 Coat	407856-0-0

IF: NC EF: A Slope: 1" Hail: SH	Insulation: 1/2" - 12" thick ISO 95+ GL (F/T) 1" - 12" thick Resista (F/T)	Adhered at 12" o.c.	Membrane: RubberGard EPDM SA	
1-465 IF: NC EF: A Slope: 1" Hail: SH	Cover Board: 1/4" - 5/8" thick DensDeck Prime/Securock Insulation: 1.5" - 36" thick ISO 95+ GL (F/T)	Cover Board: ISO Stick/Twin Jet Adhered at 12" o.c. Insulation: ISO Stick/Twin Jet Adhered at 12" o.c.	Coating (Optional): AcryliTop PC-100 Coat Membrane: RubberGard EPDM SA	375157-0-0
1-495 IF: NC EF: A Slope: 1" Hail: SH	Cover Board: 1.5" - 4" thick HailGard 7/16" - 1/2" thick OSB (APA) Insulation: 1.5" - 36" thick ISO 95+ GL (F/T)	Cover Board: ISO Stick/Twin Jet Adhered at 12" o.c. Insulation: ISO Stick/Twin Jet Adhered at 12" o.c.	Coating (Optional): AcryliTop PC-100 Coat Membrane: RubberGard EPDM SA	228339-0-0
1-495 IF: NC EF: A Slope: 3/4" Hail: SH	Cover Board: 1/2" ISOGARD HD 1" - 2.5" thick ISOGARD HD Comp. Insulation: 1.5" - 36" thick ISO 95+ GL (F/T)	Cover Board: ISO Twin Pack Adhered at 12" o.c. Insulation: ISO Twin Pack Adhered at 12" o.c.	Coating (Optional): AcryliTop PC-100 Coat Membrane: RubberGard EPDM SA	374374-0-0
1-555 IF: NC EF: A Slope: 3/4" Hail: SH	Cover Board: 1/2" ISOGARD HD 1" - 2.5" ISOGARD HD Comp. Insulation (Top): 1/2" - 4" thick ISO 95+ GL (F/T) 1" - 4" thick ISO 95+ GL (F/T) Insulation (Bottom): 1.5" - 36" thick ISO 95+ GL/Resista (F/T)	Adhesive: ISO Spray R Adhered at 12" o.c.	Coating (Optional): AcryliTop PC-100 Coat Membrane: RubberGard EPDM SA	308233-0-0
1-555 IF: NC EF: A Slope: 1" Hail: SH	Cover Board: 1/4" - 5/8" thick DensDeck Prime/Securock Insulation: 1" - 36" thick ISO 95+ GL (F/T) Resista (F)	Adhesive: ISO Spray R Adhered at 12" o.c.	Coating (Optional): AcryliTop PC-100 Coat Membrane: RubberGard EPDM SA	308353-0-0
	Cover Board: 1/4" - 5/8" thick DensDeck Prime/Securock Insulation (Top): 1/2" - 4" thick ISO 95+ GL/Resista (T) 1" - 4" thick ISO 95+ GL/Resista (T) Insulation (Bottom): 1" - 36" thick ISO 95+ GL/Resista (F/T)			308388-0-0

RubberGard EPDM SA (Adhered) – Concrete Deck – ISO/Cover Board (Adhered) (Continued)

1-645 IF: NC EF: A Slope: 3/4" Hail: SH	Cover Board: 1/2" ISOGARD HD 1" - 2.5" ISOGARD HD Comp. Insulation: 1.5" - 36" thick ISO 95+ GL (F/T)	Adhesive: ISO Stick Twin Jet Adhered at 12" o.c.	Coating (Optional): AcryliTop PC-100 Coat Membrane: RubberGard EPDM SA	374382-0-0
1-690 IF: NC EF: A Slope: 1" Hail: SH	Cover Board: 1/4" - 5/8" thick Securock Insulation (Top): 1" - 4" thick ISO 95+ GL (T) Insulation (Bottom): 1.5" - 36" thick ISO 95+ GL (F/T)	ISO Spray/square	Coating (Optional): AcryliTop PC-100 Coat Membrane: RubberGard EPDM SA	374399-0-0
1-690	Cover Board:	ISO Spray/square	Coating (Optional):	374400-0-0

IF: NC EF: A Slope: 1" Hail: SH	1/4" - 5/8" thick Securock Insulation (Top): 1.5" - 36" thick ISO 95+ GL (F/T)		AcryliTop PC-100 Coat Membrane: RubberGard EPDM SA	
1-690 IF: NC EF: A Slope: 1" Hail: SH	Cover Board: 1/4" - 5/8" thick Securock Insulation (Top): 1" - 4" thick ISO 95+ GL (T) Insulation (Bottom): 1.5" - 36" thick ISO 95+ GL (F/T)	ISO Spray/square	Coating (Optional): AcryliTop PC-100 Coat Membrane: RubberGard EPDM SA	375128-0-0
1-720 IF: NC EF: A Slope: 3/4" Hail: SH	Insulation: 1" - 12" thick Resista (F/T)	Adhesive: ISO Twin Pack Adhered at 12" o.c.	Coating (Optional): AcryliTop PC-100 Coat Membrane: RubberGard EPDM SA	405859-0-0
1-780 IF: NC EF: A Slope: 3/4" Hail: SH	Cover Board: 1/2" min. ISOGARD HD 1" - 2.5" ISOGARD HD Comp. Insulation (Top): 1/2" - 12" thick ISO 95+ GL (F/T) 1" - 12" thick Resista (F/T)	Adhesive: ISO Twin Pack Adhered at 12" o.c.	Coating (Optional): AcryliTop PC-100 Coat Membrane: RubberGard EPDM SA	407814-0-0

RubberGard EPDM SA (Adhered) – Concrete Deck – ISO (Attached) – ISO/Cover Board (Adhered)

Concrete Deck – Minimum 2,500 psi – Minimum 2" thick

Uplift	Cover Board / Insulation	C/I Attachment	Membrane	RoofNav
75 PSF IF: NC EF: A Slope: 3/4" Hail: SH	Cover Board: 1/2" ISOGARD HD 1" - 2.5" ISGOARD HD Comp. Insulation (Top): 1/2" - 8" thick ISO 95+ GL/Resista (F/T) Insulation (Bottom): 2" - 4" thick ISO 95+ GL/Resista (F/T) Vapor Barrier (Optional): 4 - 6 mil Poly V-Force w/ Primer	Cover Board: 12" o.c. beads ISO Spray R ISO Twin Pack ISO Stick Twin Jet Insulation (Top): 12" o.c. beads ISO Spray R ISO Twin Pack ISO Stick Twin Jet Insulation (Bottom): 8 Fasteners/Plates per board Concrete Drive Heavy-Duty	Coating (Optional): AcryliTop PC-100 Coat Membrane: RubberGard EPDM SA	387743-0-0

RubberGard EPDM SA (Adhered) – Concrete Deck – ISO (Attached) – ISO/Cover Board (Adhered) (Continued)

75 PSF IF: NC EF: A Slope: 3/4" Hail: SH	Cover Board: 1/2" ISOGARD HD 1" - 2.5" ISGOARD HD Comp. Insulation: 2" - 12" thick ISO 95+ GL/Resista (F/T) Vapor Barrier (Optional): 4 - 6 mil Poly V-Force w/ Primer	Cover Board: 12" o.c. beads ISO Spray R ISO Twin Pack ISO Stick Twin Jet Insulation: 8 Fasteners/Plates per board Concrete Drive Heavy-Duty	Coating (Optional): AcryliTop PC-100 Coat Membrane: RubberGard EPDM SA	387744-0-0
90 PSF IF: NC EF: A Slope: 1" Hail: SH	Cover Board: 1/4" - 5/8" thick DensDeck Prime/ 1/2" min. Securock Insulation: 1.5" - 12" thick ISO 95+ GL/Resista (F/T)	Cover Board: 12" o.c. beads ISO Spray R ISO Twin Pack Insulation: 16 Fasteners/Plates per board	Coating (Optional): AcryliTop PC-100 Coat Membrane: RubberGard EPDM SA	371066-0-0

	Vapor Barrier (Optional): V-Force w/ Primer SBS Torch	Concrete Drive Heavy-Duty		
120 PSF IF: NC EF: A Slope: 1" Hail: SH	Cover Board: 1/2" - 5/8" thick DensDeck Prime/ 1/2" min. Securock Insulation (Top): 2" - 4" thick ISO 95+ GL (F/T) Insulation (Bottom) (Optional): 2" - 8" thick ISO 95+ GL (F); 1/2" - 8" thick ISO 95+ GL/Resista (T) Vapor Barrier (Optional): 4 - 6 mil Poly	Cover Board: 6" o.c. beads ISO Spray R ISO Twin Pack ISO Stick Twin Jet Insulation (Top): 20 Fasteners/Plates per board Concrete Drive or Heavy-Duty Insulation (Bottom) (Optional): CF	Coating (Optional): AcryliTop PC-100 Coat Membrane: RubberGard EPDM SA	340794-0-0
210 PSF IF: NC EF: A Slope: 1" Hail: SH	Cover Board: 1.5" - 4" thick HailGard; 3/8" - 1/2" thick OSB (APA) Insulation (Top): 1.5" - 4" thick ISO 95+ GL (F/T) Insulation (Bottom): 2" - 4" thick ISO 95+ GL (F/T) Vapor Barrier (Optional): V-Force w/ Primer SBS Torch	Cover Board: 6" o.c. beads ISO Spray R Insulation (Top): 6" o.c. beads ISO Spray R Insulation (Bottom) (Optional): 32 Fasteners/Plates per board Concrete Drive or Heavy-Duty	Coating (Optional): AcryliTop PC-100 Coat Membrane: RubberGard EPDM SA	308012-0-0
210 PSF IF: NC EF: A Slope: 1" Hail: SH	Cover Board: 1/2" - 5/8" thick DensDeck Prime/ 1/2" min. Securock Insulation: 2" - 12" thick ISO 95+ GL (F/T) Vapor Barrier (Optional): V-Force w/ Primer SBS Torch	Cover Board: 4" o.c. beads ISO Spray R ISO Twin Pack ISO Stick Twin Jet Insulation: 32 Fasteners/Plates per board Concrete Drive or Heavy-Duty	Coating (Optional): AcryliTop PC-100 Coat Membrane: RubberGard EPDM SA	319951-0-0
270 PSF IF: NC EF: A Slope: 1/2" Hail: SH	Cover Board: 1/2" ISOGARD HD 1" - 2.5" ISOGARD HD Comp. Insulation: 2" - 12" thick ISO 95+ GL (F/T) Vapor Barrier (Optional): V-Force w/ Primer SBS Torch	Cover Board: 4" o.c. beads ISO Spray R ISO Twin Pack ISO Stick Twin Jet Insulation: 32 Fasteners/Plates per board Concrete Drive or Heavy-Duty	Coating (Optional): AcryliTop PC-100 Coat Membrane: RubberGard EPDM SA	320133-0-0

RubberGard EPDM SA (Adhered) – Steel Deck – Thermal Barrier (Attached) – ISO/Cover Board (Adhered)

Uplift	Deck	Cover Board / Insulation	C/I Attachment	Membrane	RoofNav
90 PSF Slope: 1" IF: 1 EF: A Hail: SH	Steel 16-22 ga 72" span 33 ksi	Cover Board: 1/4" - 5/8" thick DensDeck Prime/ 1/2" min. Securock Insulation (Top): 1.5" - 4" thick ISO 95+ GL (F); 1/2" - 4" thick ISO 95+ GL (T) Insulation (Bottom): 1.5" - 8" thick ISO 95+ GL (F/T) Resista (F/T) Vapor Barrier: 2 Plies, Type IV or VI	Cover Board: Hot Asphalt Insulation (Top): Hot Asphalt Insulation (Bottom): Hot Asphalt Vapor Barrier: Hot Asphalt Thermal Barrier: 16 Fasteners/Plates per board Heavy-Duty	Coating (Optional): AcryliTop PC-100 Coat Membrane: RubberGard EPDM SA	259602-0-0

		Thermal Barrier: 5/8" thick DensDeck Prime, Securock			
90 PSF Slope: 1" IF: 1 EF: A Hail: SH	Steel 16-22 ga 72" span 33 ksi	Cover Board: 1/4" - 5/8" thick DensDeck Prime/Securock Insulation: 1.5" - 12" thick ISO 95+ GL/Resista (F); 1/2" - 12" thick ISO 95+ GL/Resista (T) Vapor Barrier: 2 Plies, Type IV or VI Thermal Barrier: 5/8" thick DensDeck Prime/Securock	Cover Board: Hot Asphalt Insulation: Hot Asphalt Vapor Barrier: Hot Asphalt Thermal Barrier: 16 Fasteners/Plates per board Heavy-Duty	Coating (Optional): AcryliTop PC-100 Coat Membrane: RubberGard EPDM SA	259698-0-0
90 PSF Slope: 1" IF: 1 EF: A Hail: SH	Steel 16-22 ga 72" span 33 ksi	Cover Board: 1/4" - 5/8" thick DensDeck Prime/Securock Insulation (Top): 1/2" - 20" thick ISO 95+ GL/Resista (F/T); Insulation (Bottom): 1.5" - 4" thick ISO 95+ GL/Resista (F/T) Vapor Barrier: 2 Plies, Type IV or VI Thermal Barrier: 1/2" min. DensDeck	Cover Board: Hot Asphalt Insulation (Top): Hot Asphalt Insulation (Bottom): Hot Asphalt Vapor Barrier: Hot Asphalt Thermal Barrier: 16 Fasteners/Plates per board Heavy-Duty	Coating (Optional): AcryliTop PC-100 Coat Membrane: RubberGard EPDM SA	416634-0-0
90 PSF Slope: 1" IF: 1 EF: A Hail: SH	Steel 16-22 ga 72" span 33 ksi	Cover Board: 1/4" - 5/8" thick DensDeck Prime/Securock Insulation: 1.5" - 24" thick ISO 95+ GL/Resista (F/T); Vapor Barrier: 2 Plies, Type IV or VI Thermal Barrier: 1/2" min. DensDeck	Cover Board: Hot Asphalt Insulation: Hot Asphalt Vapor Barrier: Hot Asphalt Thermal Barrier: 16 Fasteners/Plates per board Heavy-Duty	Coating (Optional): AcryliTop PC-100 Coat Membrane: RubberGard EPDM SA	416642-0-0

RubberGard EPDM SA (Adhered) – Steel Deck – Thermal Barrier (Attached) – ISO/Cover Board (Adhered)
(Continued)

90 PSF Slope: 1" IF: 1 EF: A Hail: SH	Steel 16-22 ga 72" span 33 ksi	Cover Board: 1/4" - 5/8" thick DensDeck Prime/Securock Insulation: 1.5" - 24" thick ISO 95+ GL/Resista (F/T); Thermal Barrier: 1/2" min. DensDeck	Cover Board: Hot Asphalt Insulation: Hot Asphalt Thermal Barrier: 16 Fasteners/Plates per board Heavy-Duty	Coating (Optional): AcryliTop PC-100 Coat Membrane: RubberGard EPDM SA	416658-0-0
90 PSF Slope: 1" IF: 1 EF: A Hail: SH	Steel 16-22 ga 72" span 33 ksi	Cover Board: 1/4" - 5/8" thick DensDeck Prime/Securock Insulation (Top): 1/2" - 20" thick ISO 95+ GL/Resista (F/T);	Cover Board: Hot Asphalt Insulation (Top): Hot Asphalt Insulation (Bottom): Hot Asphalt	Coating (Optional): AcryliTop PC-100 Coat Membrane: RubberGard EPDM SA	416683-0-0

		<p>Insulation (Bottom): 1.5" - 4" thick ISO 95+ GL/Resista (F/T)</p> <p>Thermal Barrier: ½" min. DensDeck</p>	<p>Thermal Barrier: 16 Fasteners/Plates per board Heavy-Duty</p>		
<p>90 PSF Slope: 1" IF: 1 EF: A Hail: SH</p>	<p>Steel 16-22 ga 72" span 33 ksi</p>	<p>Cover Board: ¼" - ⅝" thick DensDeck Prime/Securock</p> <p>Insulation: 1.5" - 12" thick ISO 95+ GL/Resista (F/T);</p> <p>Thermal Barrier: ½" min. DensDeck/DensDeck Prime Securock</p>	<p>Cover Board and Insulation: 12" o.c. beads ISO Spray R ISO Twin Pack ISO Stick Twin Jet</p> <p>Thermal Barrier: 16 Fasteners/Plates per board Heavy-Duty</p>	<p>Coating (Optional): AcryliTop PC-100 Coat</p> <p>Membrane: RubberGard EPDM SA</p>	259777-0-0
<p>90 PSF Slope: 1" IF: 1 EF: A Hail: SH</p>	<p>Steel 16-22 ga 72" span 33 ksi</p>	<p>Cover Board: ¼" - ⅝" thick DensDeck Prime/Securock</p> <p>Insulation (Top): 1.5" - 4" thick ISO 95+ GL/Resista (F/T)</p> <p>Insulation (Bottom): 1.5" - 4" thick ISO 95+ GL/Resista (F/T)</p> <p>Thermal Barrier: ½" min. DensDeck/DensDeck Prime Securock</p>	<p>Cover Board and Insulation: 12" o.c. beads ISO Spray R ISO Twin Pack ISO Stick Twin Jet</p> <p>Thermal Barrier: 16 Fasteners/Plates per board Heavy-Duty</p>	<p>Coating (Optional): AcryliTop PC-100 Coat</p> <p>Membrane: RubberGard EPDM SA</p>	259808-0-0
<p>90 PSF Slope: 1" IF: 1 EF: A Hail: SH</p>	<p>Steel 16-22 ga 72" span 33 ksi</p>	<p>Cover Board: ½" - ⅝" thick DensDeck Prime/Securock</p> <p>Insulation: 1.5" - 12" thick ISO 95+ GL/Resista (F/T);</p> <p>Vapor Barrier: V-Force</p> <p>Thermal Barrier: ½" min. DensDeck/DensDeck Prime Securock</p>	<p>Cover Board: 12" o.c. beads ISO Spray R ISO Twin Pack</p> <p>Insulation: 12" o.c. beads ISO Spray R</p> <p>Vapor Barrier: Self Adhered</p> <p>Thermal Barrier: 12 Fasteners/Plates per board Heavy-Duty</p>	<p>Coating (Optional): AcryliTop PC-100 Coat</p> <p>Membrane: RubberGard EPDM SA</p>	372357-0-0

RubberGard EPDM SA (Adhered) – Steel Deck – Thermal Barrier (Attached) – ISO/Cover Board (Adhered)
(Continued)

<p>90 PSF Slope: 1" IF: 1 EF: A Hail: SH</p>	<p>Steel 16-22 ga 72" span 33 ksi</p>	<p>Cover Board: ¼" - ⅝" thick DensDeck Prime/Securock</p> <p>Insulation: 1.5" - 12" thick ISO 95+ GL/Resista (F/T)</p> <p>Vapor Barrier: V-Force w/ Primer</p> <p>Thermal Barrier: ¼" min. DensDeck; ½" min, Securock</p>	<p>Cover Board: 12" o.c. beads ISO Spray R ISO Twin Pack ISO Stick Twin Jet</p> <p>Insulation: 12" o.c. beads ISO Spray R ISO Twin Pack ISO Stick Twin Jet</p> <p>Vapor Barrier: Self Adhered</p> <p>Thermal Barrier:</p>	<p>Coating (Optional): AcryliTop PC-100 Coat</p> <p>Membrane: RubberGard EPDM SA</p>	375213-0-0
--	---	---	---	--	------------

			16 Fasteners/Plates per board Heavy-Duty		
90 PSF Slope: 1" IF: 1 EF: A Hail: SH	Steel 16-22 ga 72" span 33 ksi	Cover Board: ¼" - ⅝" thick DensDeck Prime/Securock Insulation (Top): 1.5" - 4" thick ISO 95+ GL/Resista (F/T) Insulation (Bottom): 1.5" - 4" thick ISO 95+ GL/Resista (F/T) Vapor Barrier: V-Force w/ Primer Thermal Barrier: ¼" min. DensDeck; ½" min, Securock	Cover Board: 12" o.c. beads ISO Spray R ISO Twin Pack ISO Stick Twin Jet Insulation: 12" o.c. beads ISO Spray R ISO Twin Pack ISO Stick Twin Jet Vapor Barrier: Self Adhered Thermal Barrier: 16 Fasteners/Plates per board Heavy-Duty	Coating (Optional): AcryliTop PC-100 Coat Membrane: RubberGard EPDM SA	375214-0-0
90 PSF Slope: 1" IF: 1 EF: A Hail: SH	Steel 16-22 ga 72" span 33 ksi	Cover Board: ¼" - ⅝" thick DensDeck Prime/Securock Insulation (Top): 1.5" - 4" thick ISO 95+ GL/Resista (F/T) Insulation (Bottom): 1.5" - 4" thick ISO 95+ GL/Resista (F/T) Vapor Barrier: V-Force w/ Primer Thermal Barrier: ¼" min. DensDeck; ½" min, Securock	Cover Board: 12" o.c. beads ISO Spray R ISO Twin Pack ISO Stick Twin Jet Insulation: 12" o.c. beads ISO Spray R ISO Twin Pack ISO Stick Twin Jet Vapor Barrier: Self Adhered Thermal Barrier: 16 Fasteners/Plates per board Heavy-Duty	Coating (Optional): AcryliTop PC-100 Coat Membrane: RubberGard EPDM SA	409051-0-0
90 PSF Slope: 1" IF: 1 EF: A Hail: SH	Steel 16-22 ga 72" span 33 ksi	Cover Board: ¼" - ⅝" thick DensDeck Prime/Securock Insulation: 1.5" - 24" thick ISO 95+ GL/Resista (F/T) Thermal Barrier: ½" min. DensDeck/DensDeck Prime	Cover Board and Insulation: 12" o.c. beads ISO Spray R ISO Twin Pack ISO Stick Twin Jet Thermal Barrier: 16 Fasteners/Plates per board Heavy-Duty	Coating (Optional): AcryliTop PC-100 Coat Membrane: RubberGard EPDM SA	416705-0-0

RubberGard EPDM SA (Adhered) – Steel Deck – Thermal Barrier (Attached) – ISO/Cover Board (Adhered)
(Continued)

90 PSF Slope: 1" IF: 1 EF: A Hail: SH	Steel 16-22 ga 72" span 33 ksi	Cover Board: ¼" - ⅝" thick DensDeck Prime/Securock Insulation (Top): ½" - 20" thick ISO 95+ GL/Resista (F/T) Insulation (Bottom): 1.5" - 4" thick ISO 95+ GL/Resista (F/T) Thermal Barrier: ½" min. DensDeck/DensDeck Prime	Cover Board: 12" o.c. beads ISO Spray R ISO Twin Pack ISO Stick Twin Jet Insulation: 12" o.c. beads ISO Twin Pack ISO Stick Twin Jet Thermal Barrier: 16 Fasteners/Plates per board Heavy-Duty	Coating (Optional): AcryliTop PC-100 Coat Membrane: RubberGard EPDM SA	416718-0-0
---	---	--	---	---	------------

<p>90 PSF</p> <p>Slope: 3/4"</p> <p>IF: 1</p> <p>EF: A</p> <p>Hail: SH</p>	<p>Steel</p> <p>16-22 ga</p> <p>72" span</p> <p>33 ksi</p>	<p>Cover Board:</p> <p>1/2" thick ISOGARD HD;</p> <p>1" - 2.5" ISOGASRD HD Comp.</p> <p>Insulation:</p> <p>1.5" - 24" thick</p> <p>ISO 95+ GL/Resista (F/T)</p> <p>Thermal Barrier:</p> <p>1/2" min.</p> <p>DensDeck</p>	<p>Cover Board:</p> <p>12" o.c. beads</p> <p>ISO Stick</p> <p>Twin Jet</p> <p>Insulation:</p> <p>12" o.c. beads</p> <p>ISO Spray R</p> <p>ISO Twin Pack</p> <p>ISO Stick</p> <p>Twin Jet</p> <p>Thermal Barrier:</p> <p>16 Fasteners/Plates per board</p> <p>Heavy-Duty</p>	<p>Coating (Optional):</p> <p>AcryliTop PC-100 Coat</p> <p>Membrane:</p> <p>RubberGard EPDM SA</p>	<p>417550-0-0</p>
<p>90 PSF</p> <p>Slope: 1"</p> <p>IF: 1</p> <p>EF: A</p> <p>Hail: SH</p>	<p>Steel</p> <p>16-22 ga</p> <p>72" span</p> <p>33 ksi</p>	<p>Cover Board:</p> <p>1.5" - 4" thick HailGard;</p> <p>3/8" - 1/2" OSB (APA)</p> <p>Insulation:</p> <p>1.5" - 12" thick</p> <p>ISO 95+ GL/Resista (F/T)</p> <p>Vapor Barrier:</p> <p>V-Force w/ Primer</p> <p>Thermal Barrier:</p> <p>1/4" min. DensDeck;</p> <p>1/2" min. Securock</p>	<p>Cover Board and Insulation:</p> <p>12" o.c. beads</p> <p>ISO Spray R</p> <p>ISO Twin Pack</p> <p>ISO Stick</p> <p>Twin Jet</p> <p>Vapor Barrier:</p> <p>Self Adhered</p> <p>Thermal Barrier:</p> <p>8 Fasteners/Plates per board</p> <p>Heavy-Duty</p>	<p>Coating (Optional):</p> <p>AcryliTop PC-100 Coat</p> <p>Membrane:</p> <p>RubberGard EPDM SA</p>	<p>294533-0-0</p>

RubberGard EPDM SA (Adhered) – Steel Deck – ISO (Attached) – ISO (Adhered)

Uplift	Deck	Vapor/Thermal	Insulation	Insulation Attachment	RoofNav
<p>75 PSF</p> <p>Slope: 1/2"</p> <p>IF: 1</p> <p>EF: A</p> <p>Hail: SH</p>	<p>Steel</p> <p>22 - 16 ga</p> <p>72" span</p> <p>33 ksi</p>	<p>Vapor Barrier:</p> <p>V-Force primer required</p> <p>Thermal Barrier:</p> <p>1/4" DensDeck;</p> <p>1/4" DensDeck Prime;</p> <p>3/8" Securock</p>	<p>Insulation (Top):</p> <p>1/2" - 9.8" thick</p> <p>ISO 95+ GL or Resista (F/T)</p> <p>Insulation (Bottom):</p> <p>2" - 4" thick</p> <p>ISO 95+ GL or Resista (F/T)</p>	<p>Insulation (Top): 12" o.c. beads</p> <p>ISO Spray R, Twin Pack, ISO Stick, Twin Jet</p> <p>Insulation (Bottom):</p> <p>8 HD Fasteners/Plates per board</p> <p>Vapor Barrier: Self Adhered</p> <p>Thermal Barrier: CF</p>	<p>385740-0-0</p>
		<p>Optional Thermal Barrier:</p> <p>1/4" DensDeck;</p> <p>1/4" DensDeck Prime;</p> <p>3/8" Securock</p>		<p>Insulation (Top): 12" o.c. beads</p> <p>ISO Spray R, Twin Pack, ISO Stick, Twin Jet</p> <p>Insulation (Bottom):</p> <p>8 HD Fasteners/Plates per board</p> <p>Optional Thermal Barrier: CF</p>	<p>385741-0-0</p>

RubberGard EPDM SA (Adhered) – Steel Deck – ISO (Attached) – ISO (Adhered) (Continued)

<p>75 PSF</p> <p>Slope: 3/4"</p> <p>IF: 1</p> <p>EF: A</p> <p>Hail: SH</p>	<p>Steel</p> <p>22 - 16 ga</p> <p>72" span</p> <p>33 ksi</p>	<p>Vapor Barrier:</p> <p>V-Force primer required</p> <p>Thermal Barrier:</p> <p>1/4" DensDeck;</p> <p>1/4" DensDeck Prime;</p> <p>3/8" Securock</p>	<p>Insulation (Top):</p> <p>1/2" - 9.8" thick</p> <p>ISO 95+ GL or Resista (F/T)</p> <p>Insulation (Bottom):</p> <p>2" - 4" thick</p> <p>ISO 95+ GL or Resista (F/T)</p>	<p>Insulation (Top):</p> <p>12" o.c. beads</p> <p>ISO Spray R, Twin Pack, ISO Stick, Twin Jet</p> <p>Insulation (Bottom):</p> <p>8 HD Fasteners/Plates per board</p> <p>Vapor Barrier: Self Adhered</p> <p>Thermal Barrier: CF</p>	<p>385760-0-0</p>
		<p>Optional Thermal Barrier:</p> <p>1/4" DensDeck;</p> <p>1/4" DensDeck Prime;</p> <p>3/8" Securock</p>		<p>Insulation (Top):</p> <p>12" o.c. beads</p> <p>ISO Spray R, Twin Pack, ISO Stick, Twin Jet</p> <p>Insulation (Bottom):</p> <p>8 HD Fasteners/Plates per board</p> <p>Optional Thermal Barrier: CF</p>	<p>385761-0-0</p>

<p>90 PSF Slope: 1/2" IF: 1 EF: A Hail: SH</p>	<p>Steel 22 - 16 ga 72" span 33 ksi</p>	<p>Vapor Barrier: V-Force primer required</p> <p>Thermal Barrier: 1/4" DensDeck; 1/4" DensDeck Prime; 3/8" Securock</p>	<p>Insulation (Top): 1/2" - 9.8" thick ISO 95+ GL or Resista (F/T)</p> <p>Insulation (Bottom): 2.2" - 4" thick ISO 95+ GL or Resista (F/T)</p>	<p>Insulation (Top): 12" o.c. beads ISO Spray R, Twin Pack, ISO Stick, Twin Jet</p> <p>Insulation (Bottom): 8 HD Fasteners/Plates per board</p> <p>Vapor Barrier: Self Adhered</p> <p>Thermal Barrier: CF</p>	384820-0-0
		<p>Optional Thermal Barrier: 1/4" DensDeck; 1/4" DensDeck Prime; 3/8" Securock</p>	<p>Insulation (Top): 12" o.c. beads ISO Spray R, Twin Pack, ISO Stick, Twin Jet</p> <p>Insulation (Bottom): 8 HD Fasteners/Plates per board</p> <p>Optional Thermal Barrier: CF</p>	348821-0-0	
<p>90 PSF Slope: 3/4" IF: 1 EF: A Hail: SH</p>	<p>Steel 22 - 16 ga 72" span 33 ksi</p>	<p>Vapor Barrier: V-Force primer required</p> <p>Thermal Barrier: 1/4" DensDeck; 1/4" DensDeck Prime; 3/8" Securock</p>	<p>Insulation (Top): 1/2" - 9.8" thick ISO 95+ GL or Resista (F/T)</p> <p>Insulation (Bottom): 2.2" - 4" thick ISO 95+ GL or Resista (F/T)</p>	<p>Insulation (Top): 12" o.c. beads ISO Spray R, Twin Pack, ISO Stick, Twin Jet</p> <p>Insulation (Bottom): 8 HD Fasteners/Plates per board</p> <p>Vapor Barrier: Self Adhered</p> <p>Thermal Barrier: CF</p>	384840-0-0
		<p>Optional Thermal Barrier: 1/4" DensDeck; 1/4" DensDeck Prime; 3/8" Securock</p>	<p>Insulation (Top): 12" o.c. beads ISO Spray R, Twin Pack, ISO Stick, Twin Jet</p> <p>Insulation (Bottom): 8 HD Fasteners/Plates per board</p> <p>Optional Thermal Barrier: CF</p>	384841-0-0	

RubberGard EPDM SA (Adhered) – Steel Deck – ISO (Attached) – ISO/Cover Board (Adhered)

Uplift	Deck	Cover Board / Insulation	C/I Attachment	Membrane	RoofNav
75 PSF Slope: 3/4" IF: 1 EF: A Hail: SH	Steel 16-22 ga 72" span 33 ksi	Cover Board: 1/2" thick ISOGARD HD; 1" – 2.5" ISOGASRD HD Comp. Insulation: 2" - 12" thick ISO 95+ GL/Resista (F/T) Vapor/Thermal Barrier (Optional): 4 or 6 mil. Poly.;; V-Force* over 1/4" DensDeck *primer may be required	Cover Board: 12" o.c. beads ISO Spray R/ISO Twin Pack/ISO Stick/Twin Jet Insulation: 8 Fasteners/Plates per board Heavy-Duty Vapor/Thermal Barrier (Optional): Loose Laid/Tape; Self Adhered/CF	Coating (Optional): AcryliTop PC-100 Coat Membrane: RubberGard EPDM SA	387706-0-0
75 PSF Slope: 1/2" IF: 1 EF: A Hail: SH	Steel 16-22 ga 72" span 33 ksi	Cover Board: 1/2" ISOGARD HD; 1" – 2.5" ISOGARD HD Comp.;; Insulation (Top): 1/2" - 8" thick ISO 95+ GL/Resista (F/T) Insulation (Bottom): 2" - 4" thick ISO 95+ GL/Resista (F/T) Vapor/Thermal Barrier (Optional): 4 or 6 mil. Poly.;; V-Force* over 1/4" DensDeck *primer may be required	Cover Board: 12" o.c. beads ISO Spray R/Twin Pack/ISO Stick/Twin Jet Insulation (Top): 12" o.c. beads ISO Spray R/Twin Pack/ISO Stick/Twin Jet Insulation (Bottom): 8 Fasteners/Plates per board Heavy-Duty Vapor/Thermal Barrier (Optional): Loose Laid/Tape; Self Adhered/CF	Membrane: RubberGard EPDM SA	387705-0-0
75 PSF Slope: 1/2" IF: 1 EF: A Hail: SH	Steel 16-22 ga 72" span 33 ksi	Cover Board: 1/4" thick DensDeck Prime/Securock Insulation: 2" - 12" thick ISO 95+ GL/Resista (F/T) Vapor/Thermal Barrier: V-Force w/ Primer Vapor/Thermal Barrier: 1/4" DensDeck/DensDeck Prime; 3/8" Securock	Cover Board: 12" o.c. beads ISO Spray R/ISO Twin Pack Insulation: 8 Fasteners/Plates per board Heavy-Duty Vapor Barrier: Self Adhered (Primer) Thermal Barrier: CF	Coating (Optional): AcryliTop PC-100 Coat Membrane: RubberGard EPDM SA	385734-0-0
75 PSF Slope: 1/2" IF: 1 EF: A Hail: SH	Steel 16-22 ga 72" span 33 ksi	Cover Board: 1/2" ISOGARD HD; 1" – 2.5" ISOGARD HD Comp.;; 1/4" min. DensDeck Prime; 1/4" min. Securock Insulation (Top): 1/2" - 9.8" thick ISO 95+ GL/Resista (F/T) Insulation (Bottom): 2" - 4" thick ISO 95+ GL/Resista (F/T) Vapor Barrier: V-Force w/ Primer Thermal Barrier: 1/4" min. DensDeck; 1/4" min. DensDeck Prime; 3/8" min. Securock	Cover Board: 12" o.c. beads ISO Spray R/Twin Pack/ISO Stick/Twin Jet Insulation (Top): 12" o.c. beads ISO Spray R/Twin Pack/ISO Stick/Twin Jet Insulation (Bottom): 8 Fasteners/Plates per board Heavy-Duty Vapor Barrier: Self-Adhered Thermal Barrier (Optional): CF	Membrane: RubberGard EPDM SA	385736-0-0

RubberGard EPDM SA (Adhered) – Steel Deck – ISO (Attached) – ISO/Cover Board (Adhered) (Continued)

<p>75 PSF Slope: 1/2" IF: 1 EF: A Hail: SH</p>	<p>Steel 16-22 ga 72" span 33 ksi</p>	<p>Cover Board: 1/2" ISOGARD HD; 1" – 2.5" ISOGARD HD Comp.; 1/4" min. DensDeck Prime; 1/4" min. Securock</p> <p>Insulation (Top): 1/2" - 9.8" thick ISO 95+ GL/Resista (F/T)</p> <p>Insulation (Bottom): 2" - 4" thick ISO 95+ GL/Resista (F/T)</p> <p>Thermal Barrier (Optional): 1/4" min. DensDeck; 1/4" min. DensDeck Prime; 1/4" min. Securock</p>	<p>Cover Board: 12" o.c. beads ISO Spray R Twin Pack ISO Stick Twin Jet</p> <p>Insulation (Top): 12" o.c. beads ISO Spray R Twin Pack ISO Stick Twin Jet</p> <p>Insulation (Bottom): 8 Fasteners/Plates per board Heavy-Duty</p> <p>Thermal Barrier (Optional): CF</p>	<p>Membrane: RubberGard EPDM SA</p>	<p>385737-0-0</p>
<p>75 PSF Slope: 1/2" IF: 1 EF: A Hail: SH</p>	<p>Steel 16-22 ga 72" span 33 ksi</p>	<p>Cover Board: 1/2" ISOGARD HD; 1" – 2.5" ISOGARD HD Comp.; 1/4" thick DensDeck Prime/Securock</p> <p>Insulation: 2" - 12" thick ISO 95+ GL/Resista (F/T)</p> <p>Vapor Barrier: V-Force w/ Primer</p> <p>Thermal Barrier: 1/4" DensDeck/DensDeck Prime; 3/8" Securock</p>	<p>Cover Board: 12" o.c. beads ISO Spray R ISO Twin Pack</p> <p>Insulation: 8 Fasteners/Plates per board Heavy-Duty</p> <p>Vapor Barrier: Self Adhered (Primer)</p> <p>Thermal Barrier: CF</p>	<p>Coating (Optional): AcryliTop PC-100 Coat</p> <p>Membrane: RubberGard EPDM SA</p>	<p>385738-0-0</p>
<p>75 PSF Slope: 1" IF: 1 EF: A Hail: SH</p>	<p>Steel 16-22 ga 72" span 33 ksi</p>	<p>Cover Board: 1/4" thick DensDeck Prime/Securock</p> <p>Insulation: 2" - 12" thick ISO 95+ GL/Resista (F/T)</p> <p>Vapor Barrier: V-Force w/ Primer</p> <p>Thermal Barrier: 1/4" DensDeck/DensDeck Prime; 3/8" Securock</p>	<p>Cover Board: 12" o.c. beads ISO Spray R ISO Twin Pack</p> <p>Insulation: 8 Fasteners/Plates per board Heavy-Duty</p> <p>Vapor Barrier: Self Adhered (Primer)</p> <p>Thermal Barrier: CF</p>	<p>Coating (Optional): AcryliTop PC-100 Coat</p> <p>Membrane: RubberGard EPDM SA</p>	<p>385746-0-0</p>
<p>75 PSF Slope: 1/2" IF: 1 EF: A Hail: SH</p>	<p>Steel 16-22 ga 72" span 33 ksi</p>	<p>Cover Board: 1/4" thick DensDeck Prime/Securock</p> <p>Insulation: 2" - 12" thick ISO 95+ GL/Resista (F/T)</p> <p>Thermal Barrier (Optional): 1/4" DensDeck/DensDeck Prime; 3/8" Securock</p>	<p>Cover Board: 12" o.c. beads ISO Spray R ISO Twin Pack</p> <p>Insulation: 8 Fasteners/Plates per board Heavy-Duty</p> <p>Thermal Barrier (Optional): CF</p>	<p>Coating (Optional): AcryliTop PC-100 Coat</p> <p>Membrane: RubberGard EPDM SA</p>	<p>385735-0-0</p>

RubberGard EPDM SA (Adhered) – Steel Deck – ISO (Attached) – ISO/Cover Board (Adhered) (Continued)

<p>75 PSF</p> <p>Slope: 1/2"</p> <p>IF: 1</p> <p>EF: A</p> <p>Hail: SH</p>	<p>Steel</p> <p>16-22 ga</p> <p>72" span</p> <p>33 ksi</p>	<p>Cover Board: 1/2" ISOGARD HD; 1" - 2.5" ISGOARD HD Comp.; 1/4" thick DensDeck Prime/Securock</p> <p>Insulation: 2" - 12" thick ISO 95+ GL/Resista (F/T)</p> <p>Thermal Barrier (Optional): 1/4" DensDeck/DensDeck Prime; 3/8" Securock</p>	<p>Cover Board: 12" o.c. beads ISO Spray R ISO Twin Pack</p> <p>Insulation: 8 Fasteners/Plates per board Heavy-Duty</p> <p>Thermal Barrier (Optional): CF</p>	<p>Coating (Optional): AcryliTop PC-100 Coat</p> <p>Membrane: RubberGard EPDM SA</p>	<p>385739-0-0</p>
<p>90 PSF</p> <p>Slope: 3/4"</p> <p>IF: 1</p> <p>EF: A</p> <p>Hail: SH</p>	<p>Steel</p> <p>16-22 ga</p> <p>72" span</p> <p>33 ksi</p>	<p>Cover Board: 1/2" ISOGARD HD; 1" - 2.5" ISGOARD HD Comp.;</p> <p>Insulation: 1.5" - 12" thick ISO 95+ GL/Resista (F/T)</p> <p>Vapor/Thermal Barrier (Optional): 4 or 6 mil. Poly.;; V-Force* over 1/4" DensDeck *primer may be required</p>	<p>Cover Board: 4" o.c. beads ISO Spray R ISO Twin Pack</p> <p>Insulation: 16 Fasteners/Plates per board Heavy-Duty</p> <p>Vapor/Thermal Barrier (Optional): Loose Laid/Tape; Self Adhered/CF</p>	<p>Coating (Optional): AcryliTop PC-100 Coat</p> <p>Membrane: RubberGard EPDM SA</p>	<p>374376-0-0</p>
<p>90 PSF</p> <p>Slope: 1/2"</p> <p>IF: 1</p> <p>EF: A</p> <p>Hail: SH</p>	<p>Steel</p> <p>16-22 ga</p> <p>72" span</p> <p>33 ksi</p>	<p>Cover Board: 1/2" ISOGARD HD; 1" - 2.5" ISOGARD HD Comp.;; 1/4" min. DensDeck Prime; 1/4" min. Securock</p> <p>Insulation (Top): 1/2" - 9.8" thick ISO 95+ GL/Resista (F/T)</p> <p>Insulation (Bottom): 2.2" - 4" thick ISO 95+ GL/Resista (F/T)</p> <p>Vapor Barrier: V-Force w/ Primer</p> <p>Thermal Barrier: 1/4" min. DensDeck; 1/4" min. DensDeck Prime; 3/8" min. Securock</p>	<p>Cover Board: 12" o.c. beads ISO Spray R/Twin Pack/ISO Stick/Twin Jet</p> <p>Insulation (Top): 12" o.c. beads ISO Spray R/Twin Pack/ISO Stick/Twin Jet</p> <p>Insulation (Bottom): 8 Fasteners/Plates per board Heavy-Duty</p> <p>Vapor Barrier: Self-Adhered</p> <p>Thermal Barrier: CF</p>	<p>Membrane: RubberGard EPDM SA</p>	<p>409207-0-0</p>
<p>90 PSF</p> <p>Slope: 1/2"</p> <p>IF: 1</p> <p>EF: A</p> <p>Hail: SH</p>	<p>Steel</p> <p>16-22 ga</p> <p>72" span</p> <p>33 ksi</p>	<p>Cover Board: 1/2" ISOGARD HD; 1" - 2.5" ISOGARD HD Comp.;; 1/4" min. DensDeck Prime; 1/4" min. Securock</p> <p>Insulation (Top): 1/2" - 9.8" thick ISO 95+ GL/Resista (F/T)</p> <p>Insulation (Bottom): 2.2" - 4" thick ISO 95+ GL/Resista (F/T)</p> <p>Thermal Barrier (Optional): 1/4" min. DensDeck; 1/4" min. DensDeck Prime; 3/8" min. Securock</p>	<p>Cover Board: 12" o.c. beads ISO Spray R/Twin Pack/ISO Stick/Twin Jet</p> <p>Insulation (Top): 12" o.c. beads ISO Spray R/Twin Pack/ISO Stick/Twin Jet</p> <p>Insulation (Bottom): 8 Fasteners/Plates per board Heavy-Duty</p> <p>Thermal Barrier: CF</p>	<p>Membrane: RubberGard EPDM SA</p>	<p>409208-0-0</p>

RubberGard EPDM SA (Adhered) – Steel Deck – ISO (Attached) – ISO/Cover Board (Adhered) (Continued)

<p>90 PSF</p> <p>Slope: 1/2"</p> <p>IF: 1</p> <p>EF: A</p> <p>Hail: SH</p>	<p>Steel</p> <p>16-22 ga</p> <p>72" span</p> <p>33 ksi</p>	<p>Cover Board:</p> <p>1/2" ISOGARD HD;</p> <p>1" – 2.5" ISGOARD HD Comp.;</p> <p>1/4" thick</p> <p>DensDeck Prime/Securock</p> <p>Insulation:</p> <p>2.2" - 12" thick</p> <p>ISO 95+ GL/Resista (F/T)</p> <p>Thermal Barrier (Optional):</p> <p>1/4" DensDeck/DensDeck Prime;</p> <p>3/8" Securock</p>	<p>Cover Board:</p> <p>12" o.c. beads</p> <p>ISO Spray RISO Twin Pack//ISO</p> <p>StickTwin Jet</p> <p>Insulation:</p> <p>8 Fasteners/Plates per board</p> <p>Heavy-Duty</p> <p>Thermal Barrier (Optional):</p> <p>CF</p>	<p>Coating (Optional):</p> <p>AcryliTop PC-100 Coat</p> <p>Membrane:</p> <p>RubberGard EPDM SA</p>	<p>384818-0-0</p>
<p>90 PSF</p> <p>Slope: 3/4"</p> <p>IF: 1</p> <p>EF: A</p> <p>Hail: SH</p>	<p>Steel</p> <p>16-22 ga</p> <p>72" span</p> <p>33 ksi</p>	<p>Cover Board:</p> <p>1/2" ISOGARD HD;</p> <p>1" – 2.5" ISGOARD HD Comp.</p> <p>Insulation:</p> <p>2.2" - 12" thick</p> <p>ISO 95+ GL/Resista (F/T)</p> <p>Vapor Barrier:</p> <p>V-Force w/ Primer</p> <p>Thermal Barrier:</p> <p>1/4" DensDeck/DensDeck Prime;</p> <p>3/8" Securock</p>	<p>Cover Board:</p> <p>12" o.c. beads</p> <p>ISO Spray R/ISO Twin Pack</p> <p>Insulation:</p> <p>8 Fasteners/Plates per board</p> <p>Heavy-Duty</p> <p>Vapor Barrier:</p> <p>Self Adhered (Primer)</p> <p>Thermal Barrier:</p> <p>CF</p>	<p>Coating (Optional):</p> <p>AcryliTop PC-100 Coat</p> <p>Membrane:</p> <p>RubberGard EPDM SA</p>	<p>384830-0-0</p>
<p>90 PSF</p> <p>Slope: 3/4"</p> <p>IF: 1</p> <p>EF: A</p> <p>Hail: SH</p>	<p>Steel</p> <p>16-22 ga</p> <p>72" span</p> <p>33 ksi</p>	<p>Cover Board:</p> <p>1/2" ISOGARD HD;</p> <p>1" – 2.5" ISOGARD HD Comp.</p> <p>Insulation (Top):</p> <p>1/2" - 9.8" thick</p> <p>ISO 95+ GL/Resista (F/T)</p> <p>Insulation (Bottom):</p> <p>2.2" - 4" thick</p> <p>ISO 95+ GL/Resista (F/T)</p> <p>Vapor Barrier:</p> <p>V-Force w/ Primer</p> <p>Thermal Barrier:</p> <p>1/4" min. DensDeck</p>	<p>Cover Board:</p> <p>12" o.c. beads</p> <p>ISO Spray R/Twin Pack/ISO</p> <p>Stick/Twin Jet</p> <p>Insulation (Top):</p> <p>12" o.c. beads</p> <p>ISO Spray R/Twin Pack/ISO</p> <p>Stick/Twin Jet</p> <p>Insulation (Bottom):</p> <p>8 Fasteners/Plates per board</p> <p>Heavy-Duty</p> <p>Vapor Barrier:</p> <p>Self-Adhered</p> <p>Thermal Barrier (Optional): CF</p>	<p>Membrane:</p> <p>RubberGard EPDM SA</p>	<p>384836-0-0</p>
<p>90 PSF</p> <p>Slope: 3/4"</p> <p>IF: 1</p> <p>EF: A</p> <p>Hail: SH</p>	<p>Steel</p> <p>16-22 ga</p> <p>72" span</p> <p>33 ksi</p>	<p>Cover Board:</p> <p>1/2" ISOGARD HD;</p> <p>1" – 2.5" ISOGARD HD Comp.</p> <p>Insulation (Top):</p> <p>1/2" - 9.8" thick</p> <p>ISO 95+ GL/Resista (F/T)</p> <p>Insulation (Bottom):</p> <p>2.2" - 4" thick</p> <p>ISO 95+ GL/Resista (F/T)</p> <p>Thermal Barrier (Optional):</p> <p>1/4" min. DensDeck</p>	<p>Cover Board:</p> <p>12" o.c. beads</p> <p>ISO Spray R/Twin Pack/ISO</p> <p>Stick/Twin Jet</p> <p>Insulation (Top):</p> <p>12" o.c. beads</p> <p>ISO Spray R/Twin Pack//ISO</p> <p>StickTwin Jet</p> <p>Insulation (Bottom):</p> <p>8 Fasteners/Plates per board</p> <p>Heavy-Duty</p> <p>Thermal Barrier (Optional): CF</p>	<p>Membrane:</p> <p>RubberGard EPDM SA</p>	<p>384837-0-0</p>

RubberGard EPDM SA (Adhered) – Steel Deck – ISO (Attached) – ISO/Cover Board (Adhered) (Continued)

210 PSF Slope: 1" IF: 1 EF: A Hail: SH	Steel (WR) 22 ga 64" span 33 ksi	Cover Board: 1.5" - 4" HailGard; 7/16" OSB (APA Rated) Insulation (Top): 1.5" - 4" thick ISO 95+ GL (F/T) Insulation (Bottom): 2" - 4" thick ISO 95+ GL (F/T) Vapor/Thermal Barrier (Optional): 4 or 6 mil. Poly.; V-Force* over 1/4" DensDeck *primer may be required	Cover Board: 6" o.c. beads ISO Spray R Insulation (Top): 6" o.c. beads ISO Spray R Insulation (Bottom): 32 Fasteners/Plates per board Heavy-Duty Vapor/Thermal Barrier (Optional): Loose Laid/Tape; Self Adhered/CF	Membrane: RubberGard EPDM SA	308040-0-0
270 PSF Slope: 1/2" IF: 1 EF: A Hail: SH	Steel (WR) 18-22 ga 72" span 80 ksi	Cover Board: 1/2" ISOGARD HD; 1" - 2.5" ISGOARD HD Comp.; Insulation: 2" - 12" thick ISO 95+ GL/Resista (F/T) Vapor/Thermal Barrier (Optional): 4 or 6 mil. Poly.; V-Force* over 1/4" DensDeck *primer may be required	Cover Board: 4" o.c. beads ISO Spray R ISO Twin Pack ISO Stick Twin Jet Insulation: 32 Fasteners/Plates per board Heavy-Duty Vapor/Thermal Barrier (Optional): Loose Laid/Tape; Self Adhered/CF	Coating (Optional): AcryliTop PC-100 Coat Membrane: RubberGard EPDM SA	320242-0-0

RubberGard EPDM SA (Adhered) – Steel Deck – ISO/Cover Board (Attached)

Uplift	Deck	Vapor/Thermal	Insulation	Insulation Attachment	RoofNav
75 PSF Slope: 1/2" IF: 1 EF: A Hail: SH	Steel 22 - 16 ga 72" span 33 ksi	Vapor/Thermal Barrier: V-Force* over 1/4" DensDeck *primer may be required	Insulation: 2" - 12" thick ISO 95+ GL (F/T)	Insulation: 8 HD Fasteners/Plates per board Vapor/Thermal Barrier: Self Adhered/CF	385742-0-0
		Vapor/Thermal Barrier: V-Force* over 1/4" DensDeck; 1/4" DensDeck Prime; 3/8" Securock *primer may be required	Insulation: 2" - 12" thick ISO 95+ GL (F/T)		385762-0-0
75 PSF Slope: 1/2" IF: 1 EF: A Hail: SH	Steel 22 - 16 ga 72" span 33 ksi	Thermal Barrier: 1/4" min. DensDeck/ DensDeck Prime	Insulation: 8 HD Fasteners/Plates per board Thermal Barrier: CF	Insulation: 8 HD Fasteners/Plates per board Thermal Barrier: CF	385743-0-0
90 PSF Slope: 1/2" IF: 1 EF: A Hail: SH	Steel 22 - 16 ga 72" span 33 ksi	Vapor/Thermal Barrier: V-Force* over 1/4" DensDeck; 1/4" DensDeck Prime; 3/8" Securock *primer required	Insulation: 8 HD Fasteners/Plates per board Thermal Barrier: CF	Insulation: 8 HD Fasteners/Plates per board Thermal Barrier: CF	384822-0-0
		Optional Thermal Barrier: 1/4" DensDeck/DensDeck Prime; 3/8" Securock			384823-0-0
90 PSF Slope: 3/4" IF: 1 EF: A Hail: SH	Steel 22 - 16 ga 72" span 33 ksi	Vapor/Thermal Barrier: V-Force* over 1/4" DensDeck; 1/4" DensDeck Prime; 3/8" Securock *primer required	Insulation: 8 HD Fasteners/Plates per board Thermal Barrier: CF	Insulation: 8 HD Fasteners/Plates per board Thermal Barrier: CF	384842-0-0
		Optional Thermal Barrier: 1/4" DensDeck/DensDeck Prime; 3/8" Securock			384843-0-0

RubberGard EPDM SA (Adhered) – Steel Deck – ISO/Cover Board (Attached)

Uplift	Deck	Cover Board / Insulation	C/I Attachment	Membrane	RoofNav
--------	------	--------------------------	----------------	----------	---------

90 PSF Slope: 1" IF: 1 EF: A Hail: SH	Steel 16-22 ga 72" span 33 ksi	Cover Board: 1/4" min. DensDeck Prime 1/2" min. Securock Insulation: 1" - 12" thick ISO 95+ GL/Resista (F/T) Vapor/Thermal Barrier (Optional): 4 or 6 mil. Poly.;; V-Force* over 1/4" DensDeck *primer may be required	Cover Board: 12 Fasteners/Plates per board Heavy-Duty Insulation: CF Vapor/Thermal Barrier (Optional): Loose Laid/Tape; Self Adhered/CF	Coating (Optional): AcryliTop PC-100 Coat Membrane: RubberGard EPDM SA	265581-0-0
90 PSF Slope: 3/4" IF: 1 EF: A Hail: SH	Steel 16-22 ga 72" span 33 ksi	Cover Board: 1/2" ISOGARD HD Insulation: 1" - 12" thick ISO 95+ GL/Resista (F/T) Vapor/Thermal Barrier (Optional): 4 or 6 mil. Poly.;; V-Force* over 1/4" DensDeck *primer may be required	Cover Board: 12 Fasteners/Plates per board Heavy-Duty Insulation: CF Vapor/Thermal Barrier (Optional): Loose Laid/Tape; Self Adhered/CF	RubberGard EPDM SA	374373-0-0
105 PSF Slope: 1" IF: 1 EF: A Hail: SH	Steel (WR) 18-22 ga 72" span 33 ksi	Cover Board: 1/4" min. DensDeck Prime Insulation: 1.5" - 12" thick ISO 95+ GL/Resista (F/T) Vapor/Thermal Barrier (Optional): 4 or 6 mil. Poly.;; V-Force* over 1/4" DensDeck; BaseGard SA* over 1/4" DensDeck *primer may be required	Cover Board: 18 Fasteners/Plates per board Heavy-Duty Insulation: CF Vapor/Thermal Barrier (Optional): Loose Laid/Tape; Self Adhered/CF	Membrane: RubberGard EPDM SA	394347-0-0
135 PSF Slope: 1" IF: 1 EF: A Hail: SH	Steel (WR) 18-22 ga 72" span 33 ksi	Cover Board: 1/2" min. DensDeck Prime Insulation: 1.5" - 12" thick ISO 95+ GL/Resista (F/T) Vapor/Thermal Barrier (Optional): 4 or 6 mil. Poly.;; V-Force* over 1/4" DensDeck; BaseGard SA* over 1/4" DensDeck *primer may be required	Cover Board: 18 Fasteners/Plates per board Heavy-Duty Insulation: CF Vapor/Thermal Barrier (Optional): Loose Laid/Tape; Self Adhered/CF	Membrane: RubberGard EPDM SA	395778-0-0
150 PSF Slope: 1" IF: 1 EF: A Hail: SH	Steel (WR) 18-22 ga 72" span 33 ksi	Cover Board: 1/2" min. DensDeck Prime Insulation: 1.5" - 12" thick ISO 95+ GL/Resista (F/T) Vapor/Thermal Barrier (Optional): 4 or 6 mil. Poly.;; V-Force* over 1/4" DensDeck; BaseGard SA* over 1/4" DensDeck *primer may be required	Cover Board: 20 Fasteners/Plates per board Heavy-Duty Insulation: CF Vapor/Thermal Barrier (Optional): Loose Laid/Tape; Self Adhered/CF	Membrane: RubberGard EPDM SA	395779-0-0

RubberGard EPDM SA (Adhered) – Steel Deck – ISO/Cover Board (Attached) (Continued)

150 PSF	Steel (WR)	Cover Board:	Cover Board:	Membrane:	200396-0-0
---------	------------	--------------	--------------	-----------	------------

Slope: 1" IF: 1 EF: A Hail: SH	18-22 ga 72" span 33 ksi	1/2" min. DensDeck Prime/Securock Insulation: 1.5" - 12" thick ISO 95+ GL (F/T) Vapor/Thermal Barrier (Optional): 4 or 6 mil. Poly.;; V-Force* over 1/4" DensDeck *primer may be required	24 Fasteners/Plates per board Heavy-Duty Insulation: CF Vapor/Thermal Barrier (Optional): Loose Laid/Tape; Self Adhered/CF	RubberGard EPDM SA	
210 PSF Slope: 1" IF: 1 EF: A Hail: SH	Steel (WR) 22 ga 64" span 33 ksi	Cover Board: 1/2" min. DensDeck Prime/Securock Insulation: 1.5" - 12" thick ISO 95+ GL (F/T) Vapor/Thermal Barrier (Optional): 4 or 6 mil. Poly.;; V-Force* over 1/4" DensDeck *primer may be required	Cover Board: 32 Fasteners/Plates per board Heavy-Duty Insulation: CF Vapor/Thermal Barrier (Optional): Loose Laid/Tape; Self Adhered/CF	Membrane: RubberGard EPDM SA	200397-0-0

Re-Roof – EPDM LS-FR (Adhered) – Steel Deck – ISO/Cover Board (Attached)

Uplift	Deck	Cover Board / Insulation	C/I Attachment	Membrane	M Attachment	RoofNav
1-75 IF: 1 EF: A Slope: 1/2"	Steel 33 KSI Insulation: LWIC	Insulation: 2"-12" thick, 4'x4' boards ISO 95+ GL ISO 95+ GL (Taper) RESISTA	Insulation: 8 Heavy-Duty or Concrete Drive Fasteners/Plates per 4'x8' board	.045 mil min. RubberGard LS-FR .060 mil. RubberGard LS-FR PT	BA-2004 Single-Ply LVOC Single-Ply LVOC 1168 WBBA - P	213740-0-0

EPDM MAX/MAX FR (Adhered) – Steel Deck – ISO/Cover Board (Attached)

Uplift	Deck	Cover Board / Insulation	C/I Attachment	Membrane	M Attachment	RoofNav
1-60 IF: 1 EF: A Slope: 1/4"	Steel 22-16 ga 33 ksi 72" span	Insulation: 1.5" -12" ISO 95+ GL ISO 95+ GL (Taper) Optional: 4 or 6 mil Poly. V-Force (Self-Adhered) DensDeck	Insulation: 10 Heavy Duty Fasteners/Plates per 4'x8' board Optional: Self-Adhered Loose Laid	.045 mil min. RubberGard MAX .045 mil. RubberGard MAX PT	BA-2004 Single-Ply LVOC Single-Ply LVOC 1168 WBBA-P	3027-0-0
1-60 IF: 1 EF: A Slope: 2.5"	Steel 22-16 ga 33 ksi 72" span	Insulation: 1.5" -12" ISO 95+ GL ISO 95+ GL (Taper) Optional: 4 or 6 mil Poly. V-Force (Self-Adhered) DensDeck	Insulation: 10 Heavy Duty Fasteners/Plates per 4'x8' board Optional: Self-Adhered Loose Laid	.045 mil min. RubberGard MAX FR	BA-2004 Single-Ply LVOC Single-Ply LVOC 1168	32791-0-0
1-90 IF: 1 EF: A Slope: 1/4"	Steel 22-16 ga 33 ksi 72" span	Insulation: 1.5" -12" ISO 95+ GL ISO 95+ GL (Taper) Optional: 4 or 6 mil Poly. V-Force (Self-Adhered)	Insulation: 12 Heavy Duty Fasteners/Plates per 4'x8' board Optional: Self-Adhered Loose Laid	.045 mil min. RubberGard MAX .045 mil. RubberGard MAX PT	BA-2004 Single-Ply LVOC Single-Ply LVOC 1168 WBBA-P	3008-0-0
1-90 IF: 1 EF: A Slope: 2.5"	Steel 22-16 ga 33 ksi 72" span	Insulation: 1.5" -12" ISO 95+ GL ISO 95+ GL (Taper) Optional: 4 or 6 mil Poly. V-Force (Self-Adhered)	Insulation: 12 Heavy Duty Fasteners/Plates per 4'x8' board Optional: Self-Adhered Loose Laid	.045 mil min. RubberGard MAX FR	BA-2004 Single-Ply LVOC Single-Ply LVOC 1168	32790-0-0

EPDM MAX/MAX FR (Adhered) – Steel Deck – ISO/Cover Board (Attached) (Continued)

1-120 IF: 1 EF: A Slope: ¼"	Steel 22-18 ga 33 ksi 72" span	Insulation: 1.5"-12" ISO 95+ GL ISO 95+ GL (Taper) Optional: 4 or 6 mil Poly. V-Force (Self-Adhered)	Insulation: 19 Heavy Duty Fasteners/Plates per 4'x8' board Optional: Self-Adhered Loose Laid	.045 mil min. RubberGard MAX .045 mil RubberGard MAX PT	BA-2004 Single-Ply LVOC Single-Ply LVOC 1168	234809-00
1-165 IF: 1 EF: A Slope: ¼"	Steel - WR 22-18 ga 33 ksi 72" span	Insulation: 1.5"-12" ISO 95+ GL ISO 95+ GL (Taper) Optional: 4 or 6 mil Poly. V-Force (Self-Adhered)	Insulation: 24 Heavy Duty Fasteners/Plates per 4'x8' board Optional: Self-Adhered Loose Laid	.045 mil min. RubberGard MAX	BA-2004 Single-Ply LVOC 1168	232547-0-0
1-165 IF: 1 EF: A Slope: 2.5"	Steel - WR 22-18 ga 33 ksi 72" span	Insulation: 1.5"-12" ISO 95+ GL ISO 95+ GL (Taper) Optional: 4 or 6 mil Poly. V-Force (Self-Adhered)	Insulation: 24 Heavy Duty Fasteners/Plates per 4'x8' board Optional: Self-Adhered Loose Laid	.045 mil min. RubberGard MAX FR	BA-2004 Single-Ply LVOC 1168	232554-0-0
1-90 IF: 1 EF: A Slope: ¼"	Steel - WR 22-16 ga 33 ksi 72" span	Insulation: 2"-12" ISO 95+ GL ISO 95+ GL (Taper) RESISTA Optional: 4 or 6 mil Poly. V-Force (Self-Adhered)	Insulation: 8 Heavy Duty Fasteners/Plates per 4'x8' board Optional: Self-Adhered Loose Laid	.045 mil min. RubberGard MAX .045 mil RubberGard MAX PT	BA-2004 Single-Ply LVOC Single-Ply LVOC 1168 WBBA-P	3029-0-0
1-165 IF: 1 EF: A Slope: ¼"	Steel - WR 22-18 ga 33 ksi 72" span	Insulation: 2"-12" ISO 95+ GL ISO 95+ GL (Taper) RESISTA Optional: 4 or 6 mil Poly. V-Force (Self-Adhered)	Insulation: 20 Heavy Duty Fasteners/Plates per 4'x8' board Optional: Self-Adhered Loose Laid	.045 mil. min. RubberGard MAX	BA-2004 Single-Ply LVOC 1168	232555-0-0
1-225 IF: 1 EF: A Slope: ¼"	Steel - WR 18ga/33ksi/72" span 20ga/33ksi/69" span 22ga/33ksi/62" span 22-18ga/80ksi/72" span	Insulation: 2"-12" ISO 95+ GL ISO 95+ GL (Taper) RESISTA Optional: 4 or 6 mil Poly. V-Force (Self-Adhered)	Insulation: 32 Heavy Duty Fasteners/Plates per 4'x8' board Optional: Self-Adhered Loose Laid	.045 mil min. RubberGard MAX .045 mil RubberGard MAX PT	BA-2004 Single-Ply LVOC Single-Ply LVOC 1168	228245-0-0
1-90 IF: 1 EF: A Slope: ¼"	Steel 22-16 ga 33 ksi 72" span	Cover Board: 1", ISOGARD HD Insulation: 1.5"-4" ISO 95+ GL ISO 95+ GL (Taper) RESISTA Optional: 4 or 6 mil Poly. V-Force (Self-Adhered)	Cover Board: 18 Heavy Duty Fasteners/Plates per 4'x8' board Insulation: Loose Laid Optional: Self-Adhered Loose Laid	.045 mil min. RubberGard MAX .045 mil. RubberGard MAX PT	BA-2004 SFBA Single-Ply LVOC Single-Ply LVOC 1168 WBBA-P	288355-0-0
1-90 IF: 1 EF: A Slope: ½"	Steel 22-16 ga 33 ksi 72" span	Cover Board: ½" min. DensDeck Securock Insulation (Optional): 1.5"-12" ISO 95+ GL ISO 95+ GL (Taper) RESISTA Optional: 4 or 6 mil Poly. V-Force (Self-Adhered) DensDeck	Cover Board: 16 Heavy Duty Fasteners/Plates per 4'x8' board Insulation: Loose Laid Optional: Self-Adhered Loose Laid	.045 mil. min. RubberGard MAX .045 mil RubberGard MAX PT	BA-2004 Single-Ply LVOC Single-Ply LVOC 1168 WBBA-P	33154-0-0

EPDM MAX/MAX FR (Adhered) – Steel Deck – ISO/Cover Board (Attached) (Continued)

1-90 IF: 1 EF: A Slope: 1/2"	Steel 22-16 ga 33 ksi 72" span	Cover Board: 1/2" min. DensDeck, Securock Insulation (Optional): 1.5"-12" ISO 95+ GL ISO 95+ GL (Taper) RESISTA Optional: 4 or 6 mil Poly. V-Force (Self-Adhered) DensDeck	Cover Board: 16 Heavy Duty Fasteners/Plates per 4'x8' board Insulation: Loose Laid Optional: Self-Adhered Loose Laid	.045 mil. min. RubberGard MAX .045 mil. RubberGard MAX PT	BA-2004 Single-Ply LVOC Single-Ply LVOC 1168 WBBA-P	33154-0-0
1-150 IF: 1 EF: A Slope: 1/2"	Steel - WR 22-18 ga 33 ksi 72" span	Cover Board: 1/2" min. DensDeck, Securock Insulation (Optional): 1.5"-12" ISO 95+ GL ISO 95+ GL (Taper) RESISTA Optional: 4 or 6 mil Poly. V-Force (Self-Adhered) DensDeck	Cover Board: 24 Heavy Duty Fasteners/Plates per 4'x8' board Insulation: Loose Laid Optional: Self-Adhered Loose Laid	.045 mil. min. RubberGard MAX .045 mil. RubberGard MAX PT	BA-2004 Single-Ply LVOC Single-Ply LVOC 1168	200399-0-0
1-210 IF: 1 EF: A Slope: 1/2"	Steel - WR 20-18ga/33ksi/72" span 22ga/33ksi/64" span 22-18ga/80ksi/72" span	Cover Board: 1/2" min. DensDeck, Securock Insulation (Optional): 2"-4" ISO 95+ GL ISO 95+ GL (Taper) RESISTA Optional: 4 or 6 mil Poly. V-Force (Self-Adhered) DensDeck	Cover Board: 32 Heavy Duty Fasteners/Plates per 4'x8' board Insulation: Loose Laid Optional: Self-Adhered Loose Laid	.045 mil. min. RubberGard MAX .045 mil. RubberGard MAX PT	BA-2004 Single-Ply LVOC Single-Ply LVOC 1168	200400-0-0
1-90 IF: 1 EF: A Slope: 1/2"	Steel 22-18 ga 33 ksi 72" span	Insulation: 2"-4" HAILGARD Optional: 4 or 6 mil Poly. V-Force (Self-Adhered) DensDeck	Insulation: 13 Heavy Duty Fasteners/Plates per 4'x8' board Optional: Self-Adhered Loose Laid	.045 mil. min. RubberGard MAX .045 mil. RubberGard MAX PT	BA-2004 SFBA Single-Ply LVOC Single-Ply LVOC 1168	136339-0-0
1-150 IF: 1 EF: A Slope: 1/2"	Steel - WR 22-18 ga 33 ksi 72" span	Cover Board: 2"-4" HAILGARD Insulation (Optional): 1.5"-12" ISO 95+ GL ISO 95+ GL (Taper) Optional: 4 or 6 mil Poly. V-Force (Self-Adhered) DensDeck	Cover Board: 16 Heavy Duty Fasteners/Plates per 4'x8' board Insulation: Loose Laid Optional: Self-Adhered Loose Laid	.045 mil. min. RubberGard MAX .045 mil. RubberGard MAX PT	BA-2004 Single-Ply LVOC Single-Ply LVOC 1168	286010-0-0
1-300 IF: 1 EF: A Slope: 1/2"	Steel - WR 18ga/33ksi/70" span 20ga/33ksi/60" span 22ga/33ksi/54" span 22-18ga/80ksi/72" span	Insulation: 2"-4" HAILGARD Optional: 4 or 6 mil Poly. V-Force (Self-Adhered) DensDeck	Insulation: 32 Heavy Duty Fasteners/Plates per 4'x8' board Optional: Self-Adhered Loose Laid	.045 mil. min. RubberGard MAX .045 mil. RubberGard MAX PT	BA-2004	213481-0-0

EPDM MAX/MAX FR (Adhered) – Steel Deck – ISO/Cover Board (Attached) (Continued)

1-150 IF: 1 EF: A Slope: 4"	Steel - WR 22-18 ga 33 ksi 72" span	Cover Board: 2"-4" HAILGARD Insulation (Optional): 1.5"-12" ISO 95+ GL ISO 95+ GL (Taper) Optional: 4 or 6 mil Poly. V-Force (Self-Adhered) DensDeck	Cover Board: 16 Heavy Duty Fasteners/Plates per 4'x8' board Insulation: Loose Laid Optional: Self-Adhered Loose Laid	.045 mil. min. RubberGard MAX FR	BA-2004 Single-Ply LVOC Single-Ply LVOC 1168	286016-0-0
1-300 IF: 1 EF: A Slope: 4"	Steel - WR 18ga/33ksi/70" span 20ga/33ksi/60" span 22ga/33ksi/54" span 22-18ga/80ksi/72" span	Insulation: 2"-4" HAILGARD Optional: 4 or 6 mil Poly. V-Force (Self-Adhered) DensDeck	Insulation: 32 Heavy Duty Fasteners/Plates per 4'x8' board Optional: Self-Adhered Loose Laid	.045 mil. min. RubberGard MAX FR	BA-2004	213490-0-0
1-90 IF: 1 EF: A Slope: 1/2"	Steel 22-16 ga 33 ksi 72" span	Cover Board: APA Rated OSB Min. 0.438", Max. 0.50" Insulation: 1.5"-12" ISO 95+ GL ISO 95+ GL (Taper) ISO 95+ GL CG Optional: 4 or 6 mil Poly. V-Force (Self-Adhered) DensDeck	Cover Board: 16 Heavy Duty Fasteners/Plates per 4'x8' board Insulation (Optional): Loose Laid Optional: Self-Adhered Loose Laid	.045 mil. min. RubberGard MAX .045 mil. RubberGard MAX PT	BA-2004 EPDM SFBA Single-Ply LVOC Single-Ply LVOC 1168 WBBA-P	33694-0-0
1-150 IF: 1 EF: A Slope: 1/2"	Steel - WR 22-18 ga 33 ksi 72" span	Cover Board: APA Rated OSB Min. 0.438", Max. 0.50" Insulation: 1.5"-12" ISOGARD ISO 95+ GL (Taper) Optional: 4 or 6 mil Poly. V-Force (Self-Adhered) DensDeck	Cover Board: 16 Heavy Duty Fasteners/Plates per 4'x8' board Insulation (Optional): Loose Laid Optional: Self-Adhered Loose Laid	.045 mil. min. RubberGard MAX .045 mil. RubberGard MAX PT	BA-2004 Single-Ply LVOC Single-Ply LVOC 1168	77820-0-0
1-150 IF: 1 EF: A Slope: 4"	Steel - WR 22-18 ga 33 ksi 72" span	Cover Board: APA Rated OSB Min. 0.438", Max. 0.50" Insulation: 1.5"-12" ISO 95+ GL ISO 95+ GL (Taper) Optional: 4 or 6 mil Poly. V-Force (Self-Adhered) DensDeck	Cover Board: 16 Heavy Duty Fasteners/Plates per 4'x8' board Insulation (Optional): Loose Laid Optional: Self-Adhered Loose Laid	.045 mil. min. RubberGard MAX FR	BA-2004 Single-Ply LVOC Single-Ply LVOC 1168	83398-0-0
1-300 IF: 1 EF: A Slope: 1/2"	Steel - WR 18ga/33ksi/70" span 20ga/33ksi/60" span 22ga/33ksi/54" span 22-18ga/80ksi/72" span	Cover Board: APA Rated OSB Min. 0.438", Max. 0.50" Insulation: 1.5"-12" ISO 95+ GL ISO 95+ GL (Taper) Optional: 4 or 6 mil Poly. V-Force (Self-Adhered) DensDeck	Cover Board: 32 Heavy Duty Fasteners/Plates per 4'x8' board Insulation (Optional): Loose Laid Optional: Self-Adhered Loose Laid	.045 mil. min. RubberGard MAX .045 mil. RubberGard MAX PT	BA-2004 Single-Ply LVOC 1168	213470-0-0

EPDM MAX/MAX FR (Adhered) – Steel Deck – ISO/Cover Board (Attached) (Continued)

1-300 IF: 1 EF: A Slope: 4"	Steel - WR 18ga/33ksi/70" span 20ga/33ksi/60" span 22ga/33ksi/54" span 22-18ga/80ksi/72" span	Cover Board: APA Rated OSB Min. 0.438" Max. 0.50" Insulation: 1.5" -12" ISO 95+ GL ISO 95+ GL (Taper) Optional: 4 or 6 mil Poly. V-Force (Self-Adhered) DensDeck	Cover Board: 32 Heavy Duty Fasteners/Plates per 4'x8' board Insulation (Optional): Loose Laid Optional: Self-Adhered Loose Laid	.045 mil. min. RubberGard MAX FR	BA-2004 Single-Ply LVOC 1168	213479-0-0
--------------------------------------	---	--	--	--	------------------------------------	------------

Re-Roof – EPDM MAX/MAX FR (Adhered) – Steel Deck – ISO/Cover Board (Attached)

Uplift	Deck	Cover Board / Insulation	C/I Attachment	Membrane	M Attachment	RoofNav
1-75 IF: 1 EF: A Slope: ¼"	Steel 33 ksi	Insulation: 1"-8" ISO 95+ GL ISO 95+ GL (Taper) RESISTA	Insulation: 12 Heavy-Duty Fasteners/Plates per 4'x8' board	.045 mil. min. RubberGard MAX .045 mil. RubberGard MAX PT	BA-2004 Single-Ply LVOC Single-Ply LVOC 1168 WBBA-P	213739-0-0
1-75 IF: 1 EF: A Slope: 2.5"	Insulation: LWIC			.045 mil. min. RubberGard MAX FR	BA-2004 Single-Ply LVOC Single-Ply LVOC 1168	213743-0-0
1-90 IF: 1 EF: A Slope: ¼"	Steel 33 ksi	Insulation: 1" ISO 95+ GL ISO 95+ GL (Taper) RESISTA	Insulation: 16 Heavy-Duty Fasteners/Plates per 4'x8' board	.045 mil. min. RubberGard MAX .045 mil. RubberGard MAX PT	BA-2004 Single-Ply LVOC Single-Ply LVOC 1168 WBBA-P	310170-0-0
1-90 IF: 1 EF: A Slope: 2.5"				.045 mil. min. RubberGard MAX FR	BA-2004 Single-Ply LVOC Single-Ply LVOC 1168	310192-0-0
1-90 IF: 1 EF: A Slope: ½"	Steel 33 ksi	Cover Board: ½" min. Securock Insulation: 1.5" -12" ISO 95+ GL ISO 95+ GL (Taper) RESISTA Optional: 4 or 6 mil Poly. V-Force (Self-Adhered) DensDeck	Cover Board: 8 Heavy-Duty Fasteners/Plates per 4'x8' board Insulation: Loose Laid Optional: Self-Adhered Loose Laid	.045 mil. min. RubberGard MAX .045 mil. RubberGard MAX PT	BA-2004 Single-Ply LVOC Single-Ply LVOC 1168 WBBA-P	372669-0-0
1-90 IF: 1 EF: A Slope: 4"				.045 mil. min. RubberGard MAX FR	BA-2004 Single-Ply LVOC Single-Ply LVOC 1168	372675-0-0

Re-Cover – EPDM MAX/MAX FR (Adhered) – Steel Deck – ISO/Cover Board (Attached)

Uplift	Deck	Cover Board / Insulation	C/I Attachment	Membrane	M Attachment	RoofNav
1-90 IF: 1 EF: A Slope: ¼"	Steel 33 ksi	Cover Board: ½", ISOGARD HD Insulation: ½" ISO 95+ GL/RESISTA	Cover Board: 12 Heavy-Duty Fasteners/Plates per 4'x8' board Insulation: Loose Laid	.045 mil. min. RubberGard MAX RubberGard MAX PT RubberGard MAX FR	BA-2004 Single-Ply LVOC Single-Ply LVOC 1168	233351-0-0
1-90 F: 1 EF: A Slope: 1.5"	Steel 33 ksi	Cover Board: ½"-1" Structodek HD Fiberboard Insulation: ½" -1.5" ISO 95+ GL Taper) RESISTA	Cover Board: 16 Heavy-Duty Fasteners/Plates per 4'x8' board Insulation: Loose Laid	.045 mil. min. RubberGard MAX RubberGard MAX PT RubberGard MAX FR	BA-2004 Single-Ply LVOC Single-Ply LVOC 1168	45188-0-0
1-120 IF: 1 EF: A Slope: ¼"	Steel 33 ksi	Cover Board: ½", ISOGARD HD Insulation: ½" ISO 95+ GL	Cover Board: 24 Heavy-Duty Fasteners/Plates per 4'x8' board	.045 mil. min. RubberGard MAX RubberGard MAX PT RubberGard MAX FR	BA-2004 Single-Ply LVOC Single-Ply LVOC 1168 WBBA-P	288115-0-0
1-120 IF: 1 EF: A Slope: 2.5"			Insulation: Loose Laid	.045 mil. min. RubberGard MAX FR	BA-2004 Single-Ply LVOC Single-Ply LVOC 1168	288149-0-0

EPDM MAX/MAX FR (Adhered) – Concrete Deck – ISO (Attached) – ISO/Cover Board (Adhered)

Uplift	Deck	Cover Board / Insulation	C/I Attachment	Membrane	M Attachment	RoofNav
1-75 IF: 1 EF: A Slope: ¼"	Concrete Min. 2,500 psi Min. 2" thick	Cover Board: 4'x4' boards ½", ISOGARD HD 1"-2.5", ISOGARD HD Composite Insulation: 2"-4" ISO 95+ GL ISO 95+ GL (Taper) RESISTA Optional: V-Force (Self-Adhered) SBS Torch	Cover Board: Adhered at 12" o.c. beads ISO Spray R ISO Twin Pack ISO Stick/Twin Jet Insulation: 8 Concrete Drive or Heavy- Duty Fasteners/Plates per 4'x8' board Optional: V-Force (Self-Adhered) w/ Primer Torched	.045 mil. min. RubberGard MAX .045 mil. RubberGard MAX PT .045 mil. min. RubberGard MAX FR	BA-2004 EPDM SFBA Single-Ply LVOC Single-Ply LVOC 1168 WBBA-P	319374-0-0
1-75 IF: 1 EF: A Slope: 2.5"						319397-0-0
1-90 IF: NC EF: A Slope: ¼"	Concrete Min. 2,500 psi Min. 2" thick	Cover Board: 4'x4' boards ½", ISOGARD HD 1"-2.5", ISOGARD HD Composite Insulation: 1.5"-4" ISO 95+ GL ISO 95+ GL (Taper) RESISTA Optional: V-Force (Self-Adhered) SBS Torch	Cover Board: Adhered at 12" o.c. beads ISO Spray R Insulation: 16 Concrete Drive or Heavy-Duty Fasteners/Plates per 4'x8' board Optional: V-Force (Self-Adhered) w/ Primer Torched	.045 mil. min. RubberGard MAX .045 mil. RubberGard MAX PT .045 mil. min. RubberGard MAX FR	BA-2004 EPDM SFBA Single-Ply LVOC Single-Ply LVOC 1168 WBBA-P	307728-0-0
1-90 IF: NC EF: A Slope: 2.5"						307735-0-0
1-90 IF: NC EF: A Slope: ¼"	Concrete Min. 2,500 psi Min. 2" thick	Cover Board: 4'x4' boards ½", ISOGARD HD 1"-2.5", ISOGARD HD Composite Insulation: 2 Layers Insulation: 1.5"-4" ISO 95+ GL ISO 95+ GL (Taper) RESISTA Optional: V-Force (Self-Adhered) SBS Torch	Cover Board: Adhered at 12" o.c. beads ISO Spray R Insulation: 16 Concrete Drive or Heavy-Duty Fasteners/Plates per 4'x8' board Optional: V-Force (Self-Adhered) w/ Primer Torched	.045 mil. min. RubberGard MAX .045 mil. RubberGard MAX PT .045 mil. min. RubberGard MAX FR	BA-2004 EPDM SFBA Single-Ply LVOC Single-Ply LVOC 1168 WBBA-P	307740-0-0
1-90 IF: NC EF: A Slope: 2.5"						307752-0-0
1-120 IF: NC EF: A Slope: ½"	Concrete Min. 2,500 psi Min. 2" thick	Cover Board: ½" min. 4'x4' boards DensDeck Prime Securock Insulation: 2"-4" ISO 95+ GL ISO 95+ GL (Taper) Insulation (Optional): 2"-8", ISO 95+ GL ½"-8" ISO 95+ GL (Taper) ½"-8" RESISTA (Taper) Vapor Retarder (Optional): 4 or 6 mil Poly.	Cover Board: Adhered at 6" o.c. beads ISO Twin Pack ISO Stick/Twin Jet Insulation: 20 Concrete Drive or Heavy-Duty Fasteners/Plates per 4'x8' board Insulation (Optional): Loose Laid Vapor Retarder (Optional): Loose Laid	.045 mil. min. RubberGard MAX .045 mil. RubberGard MAX PT .045 mil. min. RubberGard MAX FR	BA-2004 EPDM SFBA Single-Ply LVOC Single-Ply LVOC 1168	340791-0-0
1-120 IF: NC EF: A Slope: 4"						340797-0-0

EPDM MAX/MAX FR (Adhered) – Concrete Deck – ISO (Attached) – ISO/Cover Board (Adhered)
(Continued)

1-120 IF: NC EF: A Slope: ¼"	Concrete Min. 2,500 psi Min. 2" thick	Cover Board: 4'x4' boards ½" ISOGARD HD 1"-2.5", ISOGARD HD Composite 2 Layers Insulation: 2"-12" ISO 95+ GL ISO 95+ GL (Taper) Optional: V-Force (Self-Adhered) SBS Torch	Cover Board: Adhered at 4" o.c. beads ISO Spray R ISO Twin Pack ISO Stick/Twin Jet Insulation: 32 Concrete Drive or Heavy-Duty Fasteners/Plates per 4'x8' board Optional: V-Force (Self-Adhered) w/ Primer Torched	.045 mil. min. RubberGard MAX .045 mil. RubberGard MAX PT	BA-2004 EPDM SFBA Single-Ply LVOC WBBA-P	320253-0-0
1-120 IF: NC EF: A Slope: 2.5"				.045 mil. min. RubberGard MAX FR		320259-0-0

EPDM Platinum (Adhered) – Steel Deck – ISO/Cover Board (Attached)

Uplift	Deck	Cover Board / Insulation	C/I Attachment	Membrane	M Attachment	RoofNav
1-60 IF: 1 EF: A Slope: ½"	Steel 16-22 ga 33 ksi 72" span	Insulation: 1.5"-12" ISOGARD ISO 95+ GL (Taper) RESISTA Optional: 4 or 6 mil Poly. V-Force (Self-Adhered) DensDeck	Insulation: 10 Heavy-Duty Fasteners/Plates per 4'x8' board Optional: Self-Adhered Loose Laid	.090 mil. RubberGard Platinum .090 mil. RubberGard Platinum PT	BA-2004 Single-Ply LVOC Single-Ply LVOC 1168 WBBA - P	32579-0-0
1-90 IF: 1 EF: A Slope: ½"	Steel 16-22 ga 33 ksi 72" span	Insulation: 1.5"-12" ISO 95+ GL (F/T) RESISTA Optional: 4 or 6 mil Poly. V-Force (Self-Adhered) DensDeck	Insulation: 12 Heavy-Duty Fasteners/Plates per 4'x8' board Optional: Self-Adhered Loose Laid	.090 mil. RubberGard Platinum .090 mil. RubberGard Platinum PT	BA-2004 Single-Ply LVOC Single-Ply LVOC 1168 WBBA - P	32578-0-0
1-120 IF: 1 EF: A Slope: ½"	Steel 18-22 ga Wide Rib 33 ksi 72" span	Insulation: 1.5"-12" ISO 95+ GL (F/T) Optional: 4 or 6 mil Poly. V-Force (Self-Adhered) DensDeck	Insulation: 19 Heavy-Duty Fasteners/Plates per 4'x8' board Optional: Self-Adhered Loose Laid	.090 mil. RubberGard Platinum .090 mil. RubberGard Platinum PT	BA-2004 Single-Ply LVOC Single-Ply LVOC 1168	234811-0-0
1-165 IF: 1 EF: A Slope: ½"	Steel 18-22 ga Wide Rib 33 ksi 72" span	Insulation: 1.5"-12" ISO 95+ GL (F/T) Optional: 4 or 6 mil Poly. V-Force (Self-Adhered) DensDeck	Insulation: 24 Heavy-Duty Fasteners/Plates per 4'x8' board Optional: Self-Adhered Loose Laid	.090 mil. RubberGard Platinum .090 mil. RubberGard Platinum PT	BA-2004 Single-Ply LVOC 1168	232549-0-0
1-90 IF: 1 EF: A Slope: ½"	Steel 16-22 ga 33 ksi 72" span	Insulation: 2"-12" ISO 95+ GL (F/T) RESISTA Optional: 4 or 6 mil Poly. V-Force (Self-Adhered) DensDeck	Insulation: 8 Heavy-Duty Fasteners/Plates per 4'x8' board Optional: Self-Adhered Loose Laid	.090 mil. RubberGard Platinum .090 mil. RubberGard Platinum PT	BA-2004 Single-Ply LVOC Single-Ply LVOC 1168 WBBA-P	32581-0-0
1-165 IF: 1 EF: A Slope: ½"	Steel 18-22 ga Wide Rib 33 ksi 72" span	Insulation: 2"-12" ISO 95+ GL (F/T) RESISTA Optional: 4 or 6 mil Poly. V-Force (Self-Adhered) DensDeck	Insulation: 20 Heavy-Duty Fasteners/Plates per 4'x8' board Optional: Self-Adhered Loose Laid	.090 mil. RubberGard Platinum .090 mil. RubberGard Platinum PT	BA-2004 Single-Ply LVOC Single-Ply LVOC 1168	232557-0-0

EPDM Platinum (Adhered) – Steel Deck – ISO/Cover Board (Attached) (Continued)

1-225 IF: 1 EF: A Slope: 1/2"	Steel 22 ga Wide Rib 33 ksi 62" span 18-22 ga Wide Rib 80 ksi 72" span	Insulation: 2"-12" ISO 95+ GL ISO 95+ GL (Taper) RESISTA Optional: 4 or 6 mil Poly. V-Force (Self-Adhered) DensDeck	Insulation: 32 Heavy-Duty Fasteners/Plates per 4'x8' board Optional: Self-Adhered Loose Laid	.090 mil. RubberGard Platinum .090 mil. RubberGard Platinum PT	BA-2004 Single-Ply LVOC Single-Ply LVOC 1168	228247-0-0
1-90 IF: 1 EF: A Slope: 3"	Steel 16-22 ga 33 ksi 72" span	Cover Board: 1/2" DensDeck or Securock Insulation: 1.5"-12" ISO 95+ GL ISO 95+ GL (Taper) RESISTA Optional: 4 or 6 mil Poly. V-Force (Self-Adhered) DensDeck	Cover Board: 16 Heavy-Duty Fasteners/Plates per 4'x8' board Insulation: Loose Laid Optional: Self-Adhered Loose Laid	.090 mil. RubberGard Platinum .090 mil. RubberGard Platinum PT	BA-2004 Single-Ply LVOC Single-Ply LVOC 1168 WBBA-P	126884-0-0
1-90 IF: 1 EF: A Slope: 3"	Steel 16-22 ga 33 ksi 72" span	Cover Board: 1/4" DensDeck Prime; 1/2" Securock Insulation: 1"-12" ISO 95+ GL ISO 95+ GL (Taper) RESISTA Optional: 4 or 6 mil Poly.; V-Force (Self-Adhered) DensDeck	Cover Board: 12 Heavy-Duty Fasteners/Plates per 4'x8' board Insulation: Loose Laid Optional: Self-Adhered Loose Laid	.090 mil. RubberGard Platinum .090 mil. RubberGard Platinum PT	BA-2004 Single-Ply, EPDM SFBA, SPLVOC, SPLVOC 1168, WBBA- P	265585-0-0
1-90 IF: 1 EF: A Slope: 1/2"	Steel 16-22 ga 33 ksi 72" span	Cover Board: 1/2" ISOGARD HD Insulation: 1.5"-12" ISO 95+ GL ISO 95+ GL (Taper) RESISTA Optional: 4 or 6 mil Poly. V-Force (Self-Adhered) DensDeck	Cover Board: 12 Heavy-Duty Fasteners/Plates per 4'x8' board Insulation: Loose Laid Optional: Self-Adhered Loose Laid	.090 mil. RubberGard Platinum .090 mil. RubberGard Platinum PT	BA-2004 SFBA Single-Ply LVOC Single-Ply LVOC 1168	285091-0-0
1-150 IF: 1 EF: A Slope: 3"	Steel - WR 18-22 ga 33 ksi 72" span	Cover Board: 1/2" DensDeck or Securock Insulation: 1.5"-12" ISO 95+ GL ISO 95+ GL (Taper) RESISTA Optional: 4 or 6 mil Poly. V-Force (Self-Adhered)	Cover Board: 24 Heavy-Duty Fasteners/Plates per 4'x8' board Insulation: Loose Laid Optional: Self-Adhered Loose Laid	.090 mil. RubberGard Platinum .090 mil. RubberGard Platinum PT	BA-2004 Single-Ply LVOC Single-Ply LVOC 1168	200406-0-0
1-210 IF: 1 EF: A Slope: 3"	Steel - WR 20- 18ga/33ksi/ 72" span 22ga/33ksi/ 64" span 22- 18ga/80ksi/ 72" span	Cover Board: 1/2" DensDeck or Securock Insulation: 1.5"-12" ISO 95+ GL ISO 95+ GL (Taper) RESISTA Optional: 4 or 6 mil Poly. V-Force (Self-Adhered)	Cover Board: 32 Heavy-Duty Fasteners/Plates per 4'x8' board Insulation: Loose Laid Optional: Self-Adhered Loose Laid	.090 mil. RubberGard Platinum .090 mil. RubberGard Platinum PT	BA-2004 Single-Ply LVOC Single-Ply LVOC 1168	200407-0-0
1-90 IF: 1 EF: A Slope: 2"	Steel 18-20 ga 33 ksi 72" span	Insulation: 2"-4" HAILGARD Optional: 4 or 6 mil Poly. V-Force (Self-Adhered) DensDeck	Insulation: 13 HD HAILGARD Fasteners per 4'x8' board	.090 mil. RubberGard Platinum .090 mil. RubberGard Platinum PT	BA-2004 SFBA Single-Ply LVOC Single-Ply LVOC 1168	136343-0-0

EPDM Platinum (Adhered) – Steel Deck – ISO/Cover Board (Attached) (Continued)

1-150 IF: 1 EF: A Slope: 2"	Steel - WR 18-22 ga 33 ksi 72" span	Insulation: 2"-4" HAILGARD Insulation: 1.5"-12" ISO 95+ GL ISO 95+ GL (Taper) Optional: 4 or 6 mil Poly. V-Force (Self-Adhered) DensDeck	Insulation: 16 Heavy Duty Fasteners/Plates per 4'x8' board Optional: Self-Adhered Loose Laid	.090 mil. RubberGard Platinum .090 mil. RubberGard Platinum PT	BA-2004 Single-Ply LVOC Single-Ply LVOC 1168	286014-0-0
1-300 IF: 1 EF: A Slope: 1"	Steel - WR 18ga/33ksi/ 70" span 20ga/33ksi/ 60" span 22ga/33ksi/ 54" span 22- 8ga/80ksi/7 2" span	Insulation: 2"-4" HAILGARD Optional: 4 or 6 mil Poly. V-Force (Self-Adhered) DensDeck	Insulation: 32 Heavy Duty Fasteners/Plates per 4'x8' board Optional: Self-Adhered Loose Laid	.090 mil. RubberGard Platinum .090 mil. RubberGard Platinum PT	BA-2004	213482-0-0
1-90 IF: 1 EF: A Slope: 2"	Steel 16-22 ga 33 ksi 72" span	Cover Board: APA Rated OSB Min. 0.438" - Max. 0.50" Insulation: 1.5"-12" ISO 95+ GL ISO 95+ GL (Taper) RESISTA Optional: 4 or 6 mil Poly. V-Force (Self-Adhered) DensDeck	Insulation: 16 Heavy Duty Fasteners/Plates per 4'x8' board Insulation: Loose Laid Optional: Self-Adhered Loose Laid	.090 mil. RubberGard Platinum .090 mil. RubberGard Platinum PT	BA-2004 SFBA Single-Ply LVOC Single-Ply LVOC 1168 WBBA-P	127565-0-0
1-150 IF: 1 EF: A Slope: 2"	Steel - WR 18-22 ga 33 ksi 72" span	Cover Board: APA Rated OSB Min. 0.438" - Max. 0.50" Insulation: 1.5"-12" ISO 95+ GL ISO 95+ GL (Taper) Optional: 4 or 6 mil Poly. V-Force (Self-Adhered) DensDeck	Insulation: 16 Heavy Duty Fasteners/Plates per 4'x8' board Insulation: Loose Laid Optional: Self-Adhered Loose Laid	.090 mil. RubberGard Platinum .090 mil. RubberGard Platinum PT	BA-2004 Single-Ply LVOC Single-Ply LVOC 1168	127571-0-0
1-300 IF: 1 EF: A Slope: 1/2"	Steel - WR 18ga/33ksi/ 70" span 20ga/33ksi/ 60" span 22ga/33ksi/ 54" span 22- 18ga/80ksi/ 72" span	Cover Board: APA Rated OSB Min. 0.438" - Max. 0.50" Insulation: 1.5"-12" ISO 95+ GL ISO 95+ GL (Taper) Optional: 4 or 6 mil Poly. V-Force (Self-Adhered) DensDeck	Cover Board: 32 Heavy Duty Fasteners/Plates per 4'x8' board Insulation: Loose Laid Optional: Self-Adhered Loose Laid	.090 mil. RubberGard Platinum .090 mil. RubberGard Platinum PT	BA-2004 Single-Ply LVOC 1168	213471-0-0

Re-Roof – EPDM Platinum (Adhered) – Steel Deck – ISO/Cover Board (Attached)

Uplift	Deck	Cover Board / Insulation	C/I Attachment	Membrane	M Attachment	RoofNav
1-75 IF: 1 EF: A Slope: 1/2"	Steel 33 KSI Insulation: LWIC	Insulation: 2"-12" thick, 4'x4' boards ISO 95+ GL ISO 95+ GL (Taper) RESISTA	Insulation: 8 Heavy-Duty Fasteners/Plates per 4'x8' board	.090 mil. RubberGard Platinum .090 mil. RubberGard Platinum PT	BA-2004 Single-Ply LVOC Single-Ply LVOC 1168 WBBA - P	213740-0-0

EPDM Platinum (Adhered) – Concrete Deck – ISO/Cover Board (Attached)

Uplift	Deck	Cover Board / Insulation	C/I Attachment	Membrane	M Attachment	RoofNav
1-90 IF: NC EF: A Slope: ¼"	Concrete Min. 2,500 psi Min. 2" thick	Cover Board: 1", ISOGARD HD Insulation: 1.5"-4" ISO 95+ GL ISO 95+ GL (Taper) RESISTA	Insulation: 18 Heavy-Duty or Concrete Drive Fasteners/Plates per 4'x8' board	RubberGard Platinum RubberGard Platinum PT	BA-2004 Single-Ply LVOC Single-Ply LVOC 1168 WBBA - P	288348-0-0
1-90 IF: NC EF: A Slope: 3"	Concrete Min. 2,500 psi Min. 2" thick	Cover Board: ¼", DensDeck ½", Securock Insulation: 1"-12" ISO 95+ GL ISO 95+ GL (Taper) RESISTA	Insulation: 12 Heavy-Duty or Concrete Drive Fasteners/Plates per 4'x8' board	RubberGard Platinum RubberGard Platinum PT	BA-2004 Single-Ply LVOC Single-Ply LVOC 1168 WBBA - P	265632-0-0
1-120 IF: NC EF: A Slope: 1.5"	Concrete Min. 2,500 psi Min. 2" thick	Cover Board: ½", ISOGARD HD Insulation: 1.5"-4" ISO 95+ GL ISO 95+ GL (Taper)	Insulation: 24 Heavy-Duty or Concrete Drive Fasteners/Plates per 4'x8' board	RubberGard Platinum RubberGard Platinum PT	BA-2004 Single-Ply LVOC Single-Ply LVOC 1168 WBBA - P	288146-0-0

EcoWhite EPDM (Adhered) – Steel Deck – ISO/Cover Board (Attached)

Uplift	Deck	Cover Board / Insulation	C/I Attachment	Membrane	M Attachment	RoofNav
1-60 IF: 1 EF: A Slope: ½"	Steel 18-22 ga 33 ksi 72" span	Insulation: 1.5"-12" ISO 95+ GL ISO 95+ GL (Taper) RESISTA Optional: 4 or 6 mil Poly. V-Force (Self-Adhered) DensDeck	Insulation: 10 Heavy Duty Fasteners/Plates per 4'x8' board Optional: Self-Adhered Loose Laid	.060 RubberGard EcoWhite .060 RubberGard EcoWhite PT	BA-2004 Single-Ply LVOC Single-Ply LVOC 1168 WBBA-P	229856-0-0
1-90 IF: 1 EF: A Slope: ½"	Steel 16-22 ga 33 ksi 72" span	Insulation: 1.5"-12" ISO 95+ GL ISO 95+ GL (Taper) RESISTA Optional: 4 or 6 mil Poly. V-Force (Self-Adhered) DensDeck	Insulation: 12 Heavy Duty Fasteners/Plates per 4'x8' board Optional: Self-Adhered Loose Laid	.060 RubberGard EcoWhite .060 RubberGard EcoWhite PT	BA-2004 Single-Ply LVOC Single-Ply LVOC 1168 WBBA-P	229854-0-0
1-90 IF: 1 EF: A Slope: ½"	Steel 16-22 ga 33 ksi 72" span	Insulation: 2"-12" ISO 95+ GL ISO 95+ GL (Taper) RESISTA Optional: 4 or 6 mil Poly. V-Force (Self-Adhered) DensDeck	Insulation: 8 Heavy Duty Fasteners/Plates per 4'x8' board Optional: Self-Adhered Loose Laid	.060 RubberGard EcoWhite .060 RubberGard EcoWhite PT	BA-2004 Single-Ply LVOC Single-Ply LVOC 1168 WBBA-P	229858-0-0
1-90 IF: 1 EF: A Slope: ½"	Steel 16-22 ga 33 ksi 72" span	Cover Board: 1" ISOGARD HD Insulation: 1.5"-4" ISO 95+ GL ISO 95+ GL (Taper) RESISTA Optional: 4 or 6 mil Poly. V-Force (Self-Adhered) DensDeck	Cover Board: 18 Heavy Duty Fasteners/Plates per 4'x8' board Insulation: Loose Laid Optional: Self-Adhered Loose Laid	.060 RubberGard EcoWhite .060 RubberGard EcoWhite PT	BA-2004 SFBA Single-Ply LVOC Single-Ply LVOC 1168 WBBA-P	289472-0-0
1-90 IF: 1 EF: A Slope: 1.5"	Steel 16-22 ga 33 ksi 72" span	Cover Board: ½" DensDeck or Securock Insulation: 1.5"-12" ISO 95+ GL ISO 95+ GL (Taper) RESISTA Optional: 4 or 6 mil Poly. V-Force (Self-Adhered) DensDeck	Cover Board: 16 Heavy Duty Fasteners/Plates per 4'x8' board Insulation: Loose Laid Optional: Self-Adhered Loose Laid	.060 RubberGard EcoWhite .060 RubberGard EcoWhite PT	BA-2004 Single-Ply LVOC Single-Ply LVOC 1168 WBBA-P	230168-0-0

EcoWhite EPDM (Adhered) – Steel Deck – ISO/Cover Board (Attached) (Continued)

1-90 IF: 1 EF: A Slope: 1"	Steel 18-20 ga 33 ksi 72" span	Insulation: 2"-4" HAILGARD Optional: 4 or 6 mil Poly. V-Force (Self-Adhered) DensDeck	Insulation: 13 HD HAILGARD Fasteners per 4'x8' board	.060 RubberGard EcoWhite .060 RubberGard EcoWhite PT	BA-2004 SFBA Single-Ply LVOC Single-Ply LVOC 1168	229884-0-0
1-90 IF: 1 EF: A Slope: 1"	Steel 22-16 ga 33 ksi 72" span	Cover Board: APA Rated OSB Min. 0.438" - Max. 0.50" Insulation: 1.5"-12" ISO 95+ GL (F/T) RESISTA 1.4-4" ISOGARD HD COMP Optional: 4 or 6 mil Poly. V-Force (Self-Adhered) DensDeck	Cover Board: 16 Heavy Duty Fasteners/Plates per 4'x8' board Insulation: Loose Laid Optional: Self-Adhered Loose Laid	.060 RubberGard EcoWhite .060 RubberGard EcoWhite PT	BA-2004 SFBA Single-Ply LVOC Single-Ply LVOC 1168 WBBA-P	229930-0-0
1-120 IF: 1 EF: A Slope: 1/2"	Steel - WR 18-22 ga 33 ksi 72" span	Insulation: 1.5"-12" ISO 95+ GL ISO 95+ GL (Taper) Optional: 4 or 6 mil Poly. V-Force (Self-Adhered) DensDeck	Insulation: 19 Heavy Duty Fasteners/Plates per 4'x8' board Optional: Self-Adhered Loose Laid	.060 RubberGard EcoWhite	BA-2004 Single-Ply LVOC Single-Ply LVOC 1168 WBBA-P	255161-0-0
1-150 IF: 1 EF: A Slope: 1.5"	Steel 18-22 ga 33 ksi 72" span	Cover Board: 1/2", DensDeck Prime or Securock Insulation: 1.5"-12" ISO 95+ GL ISO 95+ GL (Taper) Optional: 4 or 6 mil Poly. V-Force (Self-Adhered) DensDeck	Cover Board: 24 Heavy Duty Fasteners/Plates per 4'x8' board Insulation: Loose Laid Optional: Self-Adhered Loose Laid	.060 RubberGard EcoWhite	BA-2004 Single-Ply LVOC Single-Ply LVOC 1168	230208-0-0
1-150 IF: 1 EF: A Slope: 1"	Steel - WR 18-22 ga 33 ksi 72" span	Cover Board: 2"-4" HAILGARD Insulation: 1.5"-12" ISO 95+ GL ISO 95+ GL (Taper) Optional: 4 or 6 mil Poly. V-Force (Self-Adhered) DensDeck	Cover Board: 16 Heavy Duty Fasteners/Plates per 4'x8' board Insulation: Loose Laid Optional: Self-Adhered Loose Laid	.060 RubberGard EcoWhite	BA-2004 Single-Ply LVOC Single-Ply LVOC 1168	286017-0-0
1-150 IF: 1 EF: A Slope: 1"	Steel - WR 22-18 ga 33 ksi 72" span	Cover Board: APA Rated OSB Min. 0.438" - Max. 0.50" Insulation: 1.5"-12" ISO 95+ GL ISO 95+ GL (Taper) Optional: 4 or 6 mil Poly. V-Force (Self-Adhered) DensDeck	Cover Board: 16 Heavy Duty Fasteners/Plates per 4'x8' board Insulation: Loose Laid Optional: Self-Adhered Loose Laid	.060 RubberGard EcoWhite	BA-2004 Single-Ply LVOC Single-Ply LVOC 1168	229931-0-0
1-165 IF: 1 EF: A Slope: 1/2"	Steel - WR 18-22 ga 33 ksi 72" span	Insulation: 1.5"-12" ISO 95+ GL (F/T) Optional: 4 or 6 mil Poly. V-Force (Self-Adhered) DensDeck	Insulation: 24 Heavy Duty Fasteners/Plates per 4'x8' board Optional: Self-Adhered Loose Laid	.060 RubberGard EcoWhite	BA-2004 Single-Ply LVOC 1168	255155-0-0
1-165 IF: 1 EF: A Slope: 1/2"	Steel - WR 18-22 ga 33 ksi 72" span	Insulation: 2"-12" ISO 95+ GL (F/T) RESISTA Optional: 4 or 6 mil Poly. V-Force (Self-Adhered) DensDeck	Insulation: 20 Heavy Duty Fasteners/Plates per 4'x8' board Optional: Self-Adhered Loose Laid	.060 RubberGard EcoWhite	BA-2004 Single-Ply LVOC 1168	255156-0-0

EcoWhite EPDM (Adhered) – Steel Deck – ISO/Cover Board (Attached) (Continued)

1-210 IF: 1 EF: A Slope: 1.5"	Steel - WR 20- 18ga/33ksi/ 72" span 22ga/33ksi/ 64" span 22- 18ga/80ksi/ 72" span	Cover Board: 1/2" DensDeck Prime or Securock Insulation: 1.5"-12" ISO 95+ GL ISO 95+ GL (Taper) Optional: 4 or 6 mil Poly. V-Force (Self-Adhered) DensDeck	Cover Board: 32 Heavy Duty Fasteners/Plates per 4'x8' board Insulation: Loose Laid Optional: Self-Adhered Loose Laid	.060 RubberGard EcoWhite	BA-2004 Single-Ply LVOC Single-Ply LVOC 1168	230209-0-0
1-225 IF: 1 EF: A Slope: 1/2"	Steel - WR 18ga/33ksi/ 70" span 20ga/33ksi/ 69" span 22ga/33ksi/ 62" span 22- 18ga/80ksi/ 72" span	Insulation: 2"-12" ISO 95+ GL ISO 95+ GL (Taper) Optional: 4 or 6 mil Poly. V-Force (Self-Adhered) DensDeck	Insulation: 32 Heavy Duty Fasteners/Plates per 4'x8' board Optional: Self-Adhered Loose Laid	.060 RubberGard EcoWhite	BA-2004 Single-Ply LVOC Single-Ply LVOC 1168	229911-0-0
1-300 IF: 1 EF: A Slope: 1"	Steel - WR 18ga/33ksi/ 70" span 20ga/33ksi/ 60" span 22ga/33ksi/ 54" span 22- 18ga/80ksi/ 72" span	Insulation: 2"-4" HAILGARD Optional: 4 or 6 mil Poly. V-Force (Self-Adhered) DensDeck	Insulation: 32 Heavy Duty Fasteners/Plates per 4'x8' board Optional: Self-Adhered Loose Laid	.060 RubberGard EcoWhite	BA-2004	229886-0-0
1-300 IF: 1 EF: A Slope: 1"	Steel - WR 18ga/33ksi/ 70" span 20ga/33ksi/ 60" span 22ga/33ksi/ 54" span 22- 8ga/80ksi/7 2" span	Cover Board: APA Rated OSB Min. 0.438" - Max. 0.50" Insulation: 1.5"-12" ISO 95+ GL ISO 95+ GL (Taper) Optional: 4 or 6 mil Poly. V-Force (Self-Adhered) DensDeck	Cover Board: 32 Heavy Duty Fasteners/Plates per 4'x8' board Insulation: Loose Laid Optional: Self-Adhered Loose Laid	.060 RubberGard EcoWhite	BA-2004 Single-Ply LVOC 1168	229955-0-0

EcoWhite EPDM (Adhered) – Steel Deck – ISO (Attached) – Cover Board (Adhered)

Uplift	Deck	Cover Board / Insulation	C/I Attachment	Membrane	M Attachment	RoofNav
1-120 IF: 1 EF: A Slope: 1.5"	Steel 22-18 ga 33 ksi 72" span	Cover Board: 1/2" min. DensDeck Prime/Securock Insulation (Top): 2" - 4" ISO 95+ GL; 2.3" - 13" ISOGARD GL Optional Insulation (Bottom): 2" - 8" ISO 95+ GL/RESISTA; 1/2" - 8" Tapered ISO 95+ GL/RESISTA Optional: 4 - 6 mil. poly	Cover Board: 6" o.c. beads I.S.O. Spray R I.S.O. Twin Pack I.S.O. Stick Twin Jet Insulation (Top): 20 Heavy Duty Fasteners/Plates per 4'x8' board Optional Insulation (Bottom): CF	Min. .060 RubberGard EcoWhite	BA-2004; EPDM SFBA; SP LVOC; SP LVOC 1168	340789-0-0

EcoWhite EPDM (Adhered) – Steel Deck – ISO (Attached) – Cover Board (Adhered) (Continued)

1-120 IF: 1 EF: A Slope: 1.5"	Steel 22-16 ga 33 ksi 72" span	Cover Board: ½" min. DensDeck Prime/Securock Insulation (Top): 2" – 24" ISO 95+ GL; 2.3" – 12" ISOGARD GL Vapor and Thermal Barrier: V-Force and Primer over ¼" min. DensDeck/DensDeck Prime or ⅜" Securock	Cover Board: 4" o.c. beads I.S.O. Spray R I.S.O. Twin Pack I.S.O. Stick Twin Jet Insulation: 32 Heavy Duty Fasteners/Plates per 4'x8' board Vapor and Thermal: CF	Min. .060 RubberGard EcoWhite	EPDM SFBA	425395-0-0
1-165 IF: 1 EF: A Slope: 1.5"	Steel 22-18 ga (WR) 33 ksi 72" span	Cover Board: ½" min. DensDeck Prime/Securock Insulation: 2" – 12" ISO 95+ GL/RESISTA; 2.3" – 12" ISOGARD GL/ISOGARD CG Optional: 4-6 mil. Poly; V-Force/Primer* over ¼" DensDeck	Cover Board: 4" o.c. beads I.S.O. Spray R/I.S.O. Twin Pack/I.S.O. Stick/Twin Jet Insulation: 32 Heavy Duty Fasteners/Plates per 4'x8' board Optional: CF	Min. .060 RubberGard EcoWhite	BA-2004; SP LVOC	328774-0-0

EcoWhite EPDM (Adhered) – Steel Deck – ISO (Attached) – ISO (Adhered) – Cover Board (Adhered)

Uplift	Deck	Cover Board / Insulation	C/I Attachment	Membrane	M Attachment	RoofNav
1-90 IF: 1 EF: A Slope: 1.5"	Steel 22-16 ga 33 ksi 72" span Note: Max total insulation thickness to be 12".	Cover Board: ½" min. DensDeck Prime/Securock Insulation (Top): ½" – 9.8" ISO 95+ GL/RESISTA; 2.3" – 12" ISOGARD GL/ISOGARD CG Insulation (Bottom): 2.2" – 4" ISO 95+ GL/RESISTA; 2.3" – 12" ISOGARD GL/ISOGARD CG Optional: ¼" DensDeck/DensDeck Prime; ⅜" Securock	Cover Board: 12" o.c. beads I.S.O. Spray R/I.S.O. Twin Pack/I.S.O. Stick/Twin Jet Insulation (Top): 12" o.c. beads I.S.O. Spray R/I.S.O. Twin Pack/I.S.O. Stick/Twin Jet Insulation (Bottom): 8 Heavy Duty Fasteners/Plates per 4'x8' board Optional: CF	Min. .060 RubberGard EcoWhite	BA-2004; EPDM SFBA; SP LVOC; SP LVOC 1168; WBBA-P	385321-0-0
1-90 IF: 1 EF: A Slope: 1.5"	Steel 22-16 ga 33 ksi 72" span Note: Max total insulation thickness to be 12".	Cover Board: ½" min. DensDeck Prime/Securock Insulation (Top): ½" – 9.8" ISO 95+ GL/RESISTA; 2.3" – 12" ISOGARD GL/ISOGARD CG Insulation (Bottom): 2.2" – 4" ISO 95+ GL/RESISTA; 2.3" – 12" ISOGARD GL/ISOGARD CG Vapor and Thermal Barrier: V-Force and Primer over ¼" min. DensDeck/DensDeck Prime or ⅜" Securock	Cover Board: 12" o.c. beads I.S.O. Spray R/I.S.O. Twin Pack/I.S.O. Stick/Twin Jet Insulation (Top): 12" o.c. beads I.S.O. Spray R/I.S.O. Twin Pack/I.S.O. Stick/Twin Jet Insulation (Bottom): 8 Heavy Duty Fasteners/Plates per 4'x8' board Vapor and Thermal Barrier: CF	Min. .060 RubberGard EcoWhite	BA-2004; EPDM SFBA; SP LVOC; SP LVOC 1168; WBBA-P	385320-0-0

Re-Cover – EPDM (Adhered) – Treated Wood Deck – ISO (Attached)

Uplift	Deck	Cover Board / Insulation	C/I Attachment	Membrane	M Attachment	RoofNav
1-90 IF: 1 EF: A Slope: 1/2"	Treated Wood	Insulation: 1" ISO 95+ GL ISO 95+ GL (Taper) RESISTA	Insulation: 16 All-Purpose or Heavy Duty Fasteners/Plates per 4'x8' board	.045 mil. min. RubberGard LS-FR .060 mil. RubberGard LS-FR PT	BA-2004 Single-Ply LVOC Single-Ply LVOC 1168 WBBA-P	326810-0-0
1-90 IF: 1 EF: A Slope: 1/4"				.045 mil. min. RubberGard MAX .045 mil. RubberGard MAX PT	BA-2004 Single-Ply LVOC Single-Ply LVOC 1168 WBBA-P	326806-0-0
1-90 IF: 1 EF: A Slope: 2.5"				.045 mil. min. RubberGard MAX	BA-2004 Single-Ply LVOC Single-Ply LVOC 1168	326812-0-0
1-90 IF: 1 EF: A Slope: 1/2"				.060 RubberGard EcoWhite	BA-2004 Single-Ply LVOC Single-Ply LVOC 1168 WBBA-P	326814-0-0

FM Approvals RoofNav Assemblies – Attached Membrane

EPDM LS-FR (Attached) – Steel Deck – ISO/Cover Board (Attached)

Uplift	Deck	Cover Board / Insulation	Membrane	M Attachment	RoofNav
1-60 IF: 1 EF: A Slope: 1/2"	Steel 22-16 ga 33 ksi 72" span	Insulation: ISO 95+ GL – 1.5"-12", 4'x8' boards ISO 95+ GL (Taper) – 1.5"-12", 4'x8' boards RESISTA – 1.5"-12", 4'x8' boards DensDeck – 1/4" min. Securock – 1/4" min. Attachment: Pre-securement Vapor Retarder (Optional): 4-6 min. poly V-Force (Self-Adhered) over DensDeck BaseGard SA (Self-Adhered) over DensDeck	.045 mil. min. RubberGard LS-FR	84" rows at 6" o.c. HD Fasteners and Metal or Polymer Batten	78504-0-0
1-90 IF: 1 EF: A Slope: 1/2"	Steel 22-16 ga 33 ksi 72" span	Insulation: ISO 95+ GL – 1.5"-12", 4'x8' boards ISO 95+ GL (Taper) – 1.5"-12", 4'x8' boards RESISTA – 1.5"-12", 4'x8' boards DensDeck – 1/4" min., 4'x8' boards Securock – 1/4" min., 4'x8' boards Attachment: Pre-securement Vapor Retarder (Optional): 4-6 min. poly V-Force (Self-Adhered) over DensDeck BaseGard SA (Self-Adhered) over DensDeck	.045 mil. min. RubberGard LS-FR 78" Max Width	72" rows at 6" o.c. HD Fasteners and Metal Batten	45679-0-0

EPDM LS-FR (QuickSeam R.M.A) – Steel Deck – ISO/Cover Board (Attached)

Uplift	Deck	Cover Board / Insulation	Membrane	M Attachment	RoofNav
60 PSF IF: 1 EF: A Slope: 3/4"	Steel: 22-16ga 33ksi 72" span	Insulation: ISO 95+ GL – 1"-12", 4'x8' boards Resista – 1"-12", 4'x8' boards (Taper is an option) Attachment: Pre-securement Vapor Retarder (Optional): 4-6 min. poly V-Force, primer over DensDeck BaseGard SA, primer over DensDeck	Coating: AcryliTop PC-100 Membrane: .045 mil. min. LS-FR/LS-FR PT	QuickSeam R.M.A. Strip Rows: 96" o.c. Fasteners: 12" o.c. Metal Batten/HD Fasteners	181925-0-0

EPDM LS-FR (QuickSeam R.M.A) – Steel Deck – ISO/Cover Board (Attached) (Continued)

60 PSF IF: 1 EF: A Slope: 3/4"	Steel: 22-16ga 33ksi 72" span	Cover Board: ISO GARD HD – 1/2", 4'x8' boards Attachment: Pre-securement Insulation: ISO 95+ GL – 1"-12", 4'x8' boards Resista – 1"-12", 4'x8' boards (Taper is an option) Vapor Retarder (Optional): 4-6 min. poly V-Force, primer over DensDeck BaseGard SA, primer over DensDeck	Coating: AcryliTop PC-100 Membrane: .045 mil. min. LS-FR/LS-FR PT	QuickSeam R.M.A. Strip Rows: 96" o.c. Fasteners: 12" o.c. Metal Batten/HD Fasteners	386679-0-0
60 PSF IF: 1 EF: A Slope: 1/2"	Steel: 22-16ga 33ksi 72" span	Insulation: ISO 95+ GL – 1"-12", 4'x8' boards Resista – 1"-12", 4'x8' boards (Taper is an option) Attachment: Pre-securement Vapor Retarder (Optional): 4-6 min. poly V-Force, primer over DensDeck BaseGard SA, primer over DensDeck	Coating (Optional): AcryliTop PC-100 Membrane: .045 mil. min. LS-FR/LS-FR PT Platinum/Plat PT	QuickSeam R.M.A. Strip Rows: 96" o.c. Fasteners: 12" o.c. Metal Batten/HD Fasteners	181932-0-0
75 PSF IF: 1 EF: A Slope: 3/4"	Steel: 22-16ga 33ksi 72" span	Cover Board: ISO GARD HD – 1/2", 4'x8' boards Attachment: Pre-securement Insulation: ISO 95+ GL – 1"-12", 4'x8' boards Resista – 1"-12", 4'x8' boards (Taper is an option) Vapor Retarder (Optional): 4-6 min. poly V-Force, primer over DensDeck BaseGard SA, primer over DensDeck	Coating: AcryliTop PC-100 Membrane: .045 mil. min. LS-FR/LS-FR PT	QuickSeam R.M.A. Strip Rows: 72" o.c. Fasteners: 12" o.c. Metal Batten/HD Fasteners	386681-0-0
75 PSF IF: 1 EF: A Slope: 3/4"	Steel: 22-16ga 33ksi 72" span	Insulation: ISO 95+ GL – 1"-12", 4'x8' boards Resista – 1"-12", 4'x8' boards (Taper is an option) Attachment: Pre-securement Vapor Retarder (Optional): 4-6 min. poly V-Force, primer over DensDeck BaseGard SA, primer over DensDeck	Coating: AcryliTop PC-100 Membrane: .045 mil. min. LS-FR/LS-FR PT	QuickSeam R.M.A. Strip Rows: 72" o.c. Fasteners: 12" o.c. Metal Batten/HD Fasteners	181934-0-0
75 PSF IF: 1 EF: A Slope: 1/2"	Steel: 22-16ga 33ksi 72" span	Insulation: ISO 95+ GL – 1.5"-24", 4'x8' boards Resista – 1.5"-24", 4'x8' boards (Taper is an option) Attachment: Pre-securement Vapor Retarder: V-Force, primer over 1/4" min. DensDeck	Coating (Optional): AcryliTop PC-100 Membrane: .045 mil. min. LS-FR/LS-FR PT Platinum/Plat PT	QuickSeam R.M.A. Strip Rows: 72" o.c. Fasteners: 12" o.c. Metal Batten/HD Fasteners	423140-0-0

EPDM MAX (Attached) – Steel Deck – ISO/Cover Board (Attached)

Uplift	Deck	Cover Board / Insulation	Membrane	M Attachment	RoofNav
1-60 IF: 1 EF: A Slope: 1/4"	Steel: 22-16ga/33ksi/72" span 22ga/33ksi/60" span 22ga/80ksi/72" span	Insulation: ISO 95+ GL – 1"-12", 4'x8' boards ISO 95+ GL (Taper) – 1"-12", 4'x4' boards ISO GARD HD COMP – 1"-1.5", 4'x8' boards RESISTA – 1"-12", 4'x8' boards Structodek – 1" min., 4'x8' boards DensDeck – 1/4" min., 4'x8' boards Securock – 1/4" min., 4'x8' boards Attachment: Pre-securement Vapor Retarder (Optional): 4-6 min. poly V-Force (Self-Adhered) over DensDeck BaseGard SA (Self-Adhered) over DensDeck	.045 mil. min. RubberGard MAX 10' Sheets	114" rows at 6" o.c. HD Fasteners/Plates	10931-0-0

EPDM MAX (Attached) – Steel Deck – ISO/Cover Board (Attached) (Continued)

<p>1-60 IF: 1 EF: A Slope: 1/4"</p>	<p>Steel: 22-16ga/33ksi/72" span 22ga/33ksi/60" span 22ga/80ksi/72" span</p>	<p>Cover Board: ISOGARD HD – 1/2", 4'x8' boards Attachment: Pre-securement Insulation: ISO 95+ GL – 1"-12", 4'x8' boards ISO 95+ GL (Taper) – 1"-12", 4'x4' boards RESISTA – 1"-12", 4'x8' boards Attachment: Loose Laid Vapor Retarder (Optional): 4-6 min. poly V-Force (Self-Adhered) over DensDeck BaseGard SA (Self-Adhered) over DensDeck</p>	<p>.045 mil. min. RubberGard MAX 10' Sheets</p>	<p>114" rows at 6" o.c. HD Fasteners/Plates</p>	<p>386732-0-0</p>
<p>1-60 IF: 1 EF: A Slope: 1/4"</p>	<p>Steel: 20ga/33ksi/72" span 22ga/33ksi/60" span</p>	<p>Insulation: ISO 95+ GL – 1"-12", 4'x8' boards ISO 95+ GL (Taper) – 1"-12", 4'x4' boards ISOGARD HD COMP – 1.4"-4", 4'x8' boards RESISTA – 1"-12", 4'x8' boards Structodek – 1" min., 4'x8' boards DensDeck – 1/4" min., 4'x8' boards Securock – 1/4" min., 4'x8' boards Attachment: Pre-securement Vapor Retarder (Optional): 4-6 min. poly V-Force (Self-Adhered) over DensDeck BaseGard SA (Self-Adhered) over DensDeck</p>	<p>.045 mil. min. RubberGard MAX 10' Sheets</p>	<p>114" rows at 6" o.c. HD Fasteners and Polymer Batten</p>	<p>334034-0-0</p>
<p>1-60 IF: 1 EF: A Slope: 1/4"</p>	<p>Steel: 20ga/33ksi/72" span 22ga/33ksi/60" span</p>	<p>Cover Board: ISOGARD HD – 1/2", 4'x8' boards Attachment: Pre-securement Insulation: ISO 95+ GL – 1"-12", 4'x8' boards ISO 95+ GL (Taper) – 1"-12", 4'x4' boards RESISTA – 1"-12", 4'x8' boards Attachment: Loose Laid Vapor Retarder (Optional): 4-6 min. poly V-Force (Self-Adhered) over DensDeck BaseGard SA (Self-Adhered) over DensDeck</p>	<p>.045 mil. min. RubberGard MAX 10' Sheets</p>	<p>114" rows at 6" o.c. HD Fasteners and Polymer Batten</p>	<p>386989-0-0</p>
<p>1-90 IF: 1 EF: A Slope: 1/4"</p>	<p>Steel: 18-16ga/33ksi/72" span 20ga/33ksi/48" span 20ga/80ksi/72" span 22ga/80ksi/72" span</p>	<p>Insulation: ISO 95+ GL – 1"-12", 4'x8' boards ISO 95+ GL (Taper) – 1"-12", 4'x4' boards ISOGARD HD COMP – 1.4"-4", 4'x8' boards RESISTA – 1"-12", 4'x8' boards Structodek – 1" min., 4'x8' boards FiberTop B – 1/2" min., 4'x8' boards DensDeck – 1/4" min., 4'x8' boards Securock – 1/4" min., 4'x8' boards Attachment: Pre-securement Vapor Retarder (Optional): 4-6 min. poly V-Force (Self-Adhered) over DensDeck BaseGard SA (Self-Adhered) over DensDeck</p>	<p>.045 mil. min. RubberGard MAX 10' Sheets</p>	<p>114" rows at 6" o.c. HD Fasteners and Polymer Batten</p>	<p>11488-0-0</p>
<p>1-90 IF: 1 EF: A Slope: 1/4"</p>	<p>Steel: 18-16ga/33ksi/72" span 20ga/33ksi/48" span 20ga/80ksi/72" span 22ga/80ksi/72" span</p>	<p>Cover Board: ISOGARD HD – 1/2", 4'x8' boards Attachment: Pre-securement Insulation: ISO 95+ GL – 1"-12", 4'x8' boards ISO 95+ GL (Taper) – 1"-12", 4'x4' boards RESISTA – 1"-12", 4'x8' boards Attachment: Loose Laid Vapor Retarder (Optional): 4-6 min. poly V-Force (Self-Adhered) over DensDeck BaseGard SA (Self-Adhered) over DensDeck</p>	<p>.045 mil. min. RubberGard MAX 10' Sheets</p>	<p>114" rows at 6" o.c. HD Fasteners and Polymer Batten</p>	<p>386741-0-0</p>

EPDM MAX (Attached) – Steel Deck – ISO/Cover Board (Attached) (Continued)

1-120 IF: 1 EF: A Slope: ¼"	Steel: Wide Rib 20-18ga/80ksi/72" span 22ga/80ksi/54" span	Cover Board: ISOGARD HD – ½", 4'x8' boards Attachment: Pre-securement Insulation: ISO 95+ GL – 1"-12", 4'x8' boards ISO 95+ GL (Taper) – 1"-12", 4'x4' boards Attachment: Loose Laid Vapor Retarder (Optional): 4-6 min. poly V-Force (Self-Adhered) over DensDeck BaseGard SA (Self-Adhered) over DensDeck	.045 mil. min. RubberGard MAX 10' Sheets	114" rows at 6" o.c. HD Plus Fasteners and Polymer Batten Additional: Mid-span attachment at 12" o.c. stripped in with cover strip.	386950-0-0
1-120 IF: 1 EF: A Slope: ¼"	Steel: Wide Rib 20-18ga/80ksi/72" span 22ga/80ksi/54" span	Insulation: ISO 95+ GL – 1"-12", 4'x8' boards ISO 95+ GL (Taper) – 1"-12", 4'x4' boards ISOGARD HD COMP – 1.4"-4", 4'x8' boards RESISTA – 1"-12", 4'x8' boards Structodek – 1" min., 4'x8' boards FiberTop B – ½" min., 4'x8' boards DensDeck – ¼" min., 4'x8' boards Securock – ¼" min., 4'x8' boards Attachment: Pre-securement Vapor Retarder (Optional): 4-6 min. poly V-Force (Self-Adhered) over DensDeck BaseGard SA (Self-Adhered) over DensDeck	.045 mil. min. RubberGard MAX 10' Sheets	114" rows at 6" o.c. HD Plus Fasteners and Polymer Batten Additional: Mid-span attachment at 12" o.c. stripped in with cover strip.	128862-0-0

EPDM MAX FR (Attached) – Steel Deck – ISO/Cover Board (Attached)

Uplift	Deck	Cover Board / Insulation	Membrane	M Attachment	RoofNav
1-60 IF: 1 EF: A Slope: 2"	Steel: 20-16ga/33ksi/72" span 22ga/33ksi/60" span 22ga/80ksi/72" span	Insulation: ISO 95+ GL – 1"-12", 4'x8' boards ISO 95+ GL (Taper) – 1"-12", 4'x4' boards RESISTA – 1"-12", 4'x8' boards Attachment: Pre-securement Vapor Retarder (Optional): 4-6 min. poly V-Force (Self-Adhered) over DensDeck BaseGard SA (Self-Adhered) over DensDeck	.045 mil. min. RubberGard MAX FR 10' Sheets	114" rows at 6" o.c. HD Fasteners and V-Plates	386470-0-0
1-60 IF: 1 EF: A Slope: 3"	Steel: 20-16ga/33ksi/72" span 22ga/33ksi/60" span 22ga/80ksi/72" span	Insulation: Structodek – 1" min., 4'x8' boards DensDeck/Securock – ¼" min., 4'x8' boards Attachment: Pre-securement Vapor Retarder (Optional): 4-6 min. poly V-Force (Self-Adhered) over DensDeck BaseGard SA (Self-Adhered) over DensDeck	.045 mil. min. RubberGard MAX FR 10' Sheets	114" rows at 6" o.c. HD Fasteners and V-Plates	48124-0-0
1-60 IF: 1 EF: A Slope: 2"	Steel: 20-16ga/33ksi/72" span 22ga/33ksi/60" span 22ga/80ksi/72" span	Insulation: ISO 95+ GL – 1"-12", 4'x8' boards ISO 95+ GL (Taper) – 1"-12", 4'x4' boards ISOGARD HD COMP – 1.4"-4", 4'x8' boards RESISTA – 1"-12", 4'x8' boards Attachment: Pre-securement Vapor Retarder (Optional): 4-6 min. poly V-Force (Self-Adhered) over DensDeck BaseGard SA (Self-Adhered) over DensDeck	.045 mil. min. RubberGard MAX FR 10' Sheets	114" rows at 6" o.c. HD Fasteners and V-Plates	47996-0-0
1-90 IF: 1 EF: A Slope: 2"	Steel: 22ga/80ksi/72" span	Cover Board: ISOGARD HD – ½", 4'x8' boards Attachment: Pre-securement Insulation: ISO 95+ GL – 1"-12", 4'x8' boards ISO 95+ GL (Taper) – 1"-12", 4'x4' boards RESISTA – 1"-12", 4'x8' boards Attachment: Loose Laid Vapor Retarder (Optional): 4-6 min. poly V-Force (Self-Adhered) over DensDeck BaseGard SA (Self-Adhered) over DensDeck	.045 mil. min. RubberGard MAX FR 10' Sheets	114" rows at 12" o.c. HD Plus Fasteners and Polymer Batten Additional: Mid-span attachment at 12" o.c. stripped in with cover strip.	386601-0-0

EPDM MAX FR (Attached) – Steel Deck – ISO/Cover Board (Attached) (Continued)

1-90 IF: 1 EF: A Slope: 2"	Steel: 22ga/80ksi/72" span	Insulation: ISO 95+ GL – 1"-12", 4'x8' boards ISO 95+ GL (Taper) – 1"-12", 4'x4' boards ISOGARD HD COMP – 1.4"-4", 4'x8' boards RESISTA – 1"-12", 4'x8' boards Attachment: Pre-securement Vapor Retarder (Optional): 4-6 min. poly V-Force (Self-Adhered) over DensDeck BaseGard SA (Self-Adhered) over DensDeck	.045 mil. min. RubberGard MAX FR 10' Sheets	114" rows at 12" o.c. HD Plus Fasteners and Polymer Batten Additional: Mid-span attachment at 12" o.c. stripped in with cover strip.	330918-0-0
1-90 IF: 1 EF: A Slope: 3"	Steel: 22ga/80ksi/72" span	Insulation: Structodek – 1/2" min., 4'x8' boards DensDeck – 1/4" min., 4'x8' boards Securock – 1/4" min., 4'x8' boards Attachment: Pre-securement Vapor Retarder (Optional): 4-6 min. poly V-Force (Self-Adhered) over DensDeck BaseGard SA (Self-Adhered) over DensDeck	.045 mil. min. RubberGard MAX FR 10' Sheets	114" rows at 12" o.c. HD Plus Fasteners and Polymer Batten Additional: Mid-span attachment at 12" o.c. stripped in with cover strip.	330922-0-0
1-90 IF: 1 EF: A Slope: 3"	Steel: 22ga/80ksi/72" span	Cover Board: Structodek – 1" min., 4'x8' boards DensDeck – 1/4" min., 4'x8' boards Securock – 1/4" min., 4'x8' boards Attachment: Pre-securement Insulation: ISO 95+ GL – 1.5"-12", 4'x8' boards ISO 95+ GL (Taper) – 1.5"-12", 4'x4' boards ISOGARD HD COMP – 1.4"-4", 4'x8' boards RESISTA – 1.5"-12", 4'x8' boards Attachment: Loose Laid Vapor Retarder (Optional): 4-6 min. poly V-Force (Self-Adhered) over DensDeck BaseGard SA (Self-Adhered) over DensDeck	.045 mil. min. RubberGard MAX FR 10' Sheets	114" rows at 12" o.c. HD Plus Fasteners and Polymer Batten Additional: Mid-span attachment at 12" o.c. stripped in with cover strip.	330925-0-0
1-120 IF: 1 EF: A Slope: 2"	Steel: Wide Rib 20- 18ga/80ksi/72" span 22ga/80ksi/54" span	Cover Board: ISOGARD HD – 1/2", 4'x8' boards Attachment: Pre-securement Insulation: ISO 95+ GL – 1"-12", 4'x8' boards ISO 95+ GL (Taper) – 1"-12", 4'x4' boards Attachment: Loose Laid Vapor Retarder (Optional): 4-6 min. poly V-Force (Self-Adhered) over DensDeck BaseGard SA (Self-Adhered) over DensDeck	.045 mil. min. RubberGard MAX FR 10' Sheets	114" rows at 12" o.c. HD Plus Fasteners and Polymer Batten Additional: Mid-span attachment at 12" o.c. stripped in with cover strip.	386569-0-0
1-120 IF: 1 EF: A Slope: 3"	Steel: Wide Rib 20- 18ga/80ksi/72" span 22ga/80ksi/54" span	Cover Board: Structodek – 1/2" min., 4'x8' boards DensDeck – 1/4" min., 4'x8' boards Securock – 1/4" min., 4'x8' boards Attachment: Pre-securement Insulation: ISO 95+ GL – 1.5"-12", 4'x8' boards ISO 95+ GL (Taper) – 1.5"-12", 4'x4' boards ISOGARD HD COMP – 1.4"-4", 4'x8' boards Attachment: Loose Laid Vapor Retarder (Optional): 4-6 min. poly V-Force (Self-Adhered) over DensDeck BaseGard SA (Self-Adhered) over DensDeck	.045 mil. min. RubberGard MAX FR 10' Sheets	114" rows at 12" o.c. HD Plus Fasteners and Polymer Batten Additional: Mid-span attachment at 12" o.c. stripped in with cover strip.	128968-0-0
1-120 IF: 1 EF: A Slope: 2"	Steel: Wide Rib 20- 18ga/80ksi/72" span 22ga/80ksi/54" span	Insulation: ISO 95+ GL – 1"-12", 4'x8' boards ISO 95+ GL (Taper) – 1"-12", 4'x4' boards ISOGARD HD COMP – 1.4"-4", 4'x8' boards Attachment: Pre-securement Vapor Retarder (Optional): 4-6 min. poly V-Force (Self-Adhered) over DensDeck BaseGard SA (Self-Adhered) over DensDeck	.045 mil. min. RubberGard MAX FR 10' Sheets	114" rows at 12" o.c. HD Plus Fasteners and Polymer Batten Additional: Mid-span attachment at 12" o.c. stripped in with cover strip.	128880-0-0

EPDM MAX FR (Attached) – Steel Deck – ISO/Cover Board (Attached) (Continued)

1-120 IF: 1 EF: A Slope: 3"	Steel: Wide Rib 20- 18ga/80ksi/72" span 22ga/80ksi/54" span	Cover Board: Structodek – 1" min., 4'x8' boards DensDeck – ¼" min., 4'x8' boards Securock – ¼" min., 4'x8' boards Attachment: Pre-securement Vapor Retarder (Optional): 4-6 min. poly V-Force (Self-Adhered) over DensDeck BaseGard SA (Self-Adhered) over DensDeck	.045 mil. min. RubberGard MAX FR 10' Sheets	114" rows at 12" o.c. HD Plus Fasteners and Polymer Batten Additional: Mid-span attachment at 12" o.c. stripped in with cover strip.	128882-0-0
--------------------------------------	--	---	--	--	------------

EPDM MAX (QuickSeam R.M.A.) – Steel Deck – ISO/Cover Board (Attached)

Uplift	Deck	Cover Board / Insulation	Membrane	M Attachment	RoofNav
1-60 IF: 1 EF: A Slope: ¼"	Steel: 20-16ga/33ksi/72" span 22ga/33ksi/60" span 22ga/80ksi/72" span	Insulation: ISO 95+ GL – 1"-12", 4'x8' boards ISO 95+ GL (Taper) – 1"-12", 4'x4' boards ISOGARD HD COMP – 1.4"-4", 4'x8' boards RESISTA – 1"-12", 4'x8' boards Structodek – ½", 4'x8' boards DensDeck – ¼" min., 4'x8' boards Securock – ¼" min., 4'x8' boards FiberTop B – ½", 4'x8' boards Attachment: Pre-securement Vapor Retarder (Optional): 4-6 min. poly V-Force (Self-Adhered) over DensDeck BaseGard SA (Self-Adhered) over DensDeck	.045 mil. min. RubberGard MAX	QuickSeam R.M.A. Strip Polymer Batten 114" rows, 6" o.c. QuickSeam R.M.A. Strip Heavy Duty Fasteners/Plates 114" rows, 6" o.c.	79883-0-0
1-60 IF: 1 EF: A Slope: ½"	Steel: 20-16ga/33ksi/72" span 22ga/33ksi/60" span 22ga/80ksi/72" span	Insulation: Structodek – ½", 4'x8' boards DensDeck – ¼" min., 4'x8' boards Securock – ¼" min., 4'x8' boards FiberTop B – ½", 4'x8' boards Attachment: Pre-securement Vapor Retarder (Optional): 4-6 min. poly V-Force (Self-Adhered) over DensDeck BaseGard SA (Self-Adhered) over DensDeck	.045 mil. min. RubberGard MAX	QuickSeam R.M.A. Strip Polymer Batten 114" rows, 6" o.c. QuickSeam R.M.A. Strip Heavy Duty Fasteners/Plates 114" rows, 6" o.c.	80045-0-0
1-90 IF: 1 EF: A Slope: ½"	Steel: 18-16ga/33ksi/72" span 20ga/33ksi/48" span 20g/80ksi/72" span 22ga/80ksi/72" span	Insulation: Structodek – ½", 4'x8' boards DensDeck – ¼" min., 4'x8' boards Securock – ¼" min., 4'x8' boards FiberTop B – ½", 4'x8' boards Attachment: Pre-securement Vapor Retarder (Optional): 4-6 min. poly V-Force (Self-Adhered) over DensDeck BaseGard SA (Self-Adhered) over DensDeck	.045 mil. min. RubberGard MAX	QuickSeam R.M.A. Strip Polymer Batten 114" rows, 6" o.c. QuickSeam R.M.A. Strip Heavy Duty Fasteners/Plates 114" rows, 6" o.c.	80061-0-0
1-90 IF: 1 EF: A Slope: ¼"	Steel: 18-16ga/33ksi/72" span 20ga/33ksi/48" span 20g/80ksi/72" span 22ga/80ksi/72" span	Insulation: ISO 95+ GL – 1"-12", 4'x8' boards ISO 95+ GL (Taper) – 1"-12", 4'x4' boards ISOGARD HD COMP – 1.4"-4", 4'x8' boards RESISTA – 1"-12", 4'x8' boards Structodek – ½", 4'x8' boards DensDeck – ¼" min., 4'x8' boards Securock – ¼" min., 4'x8' boards FiberTop B – ½", 4'x8' boards Attachment: Pre-securement Vapor Retarder (Optional): 4-6 min. poly V-Force (Self-Adhered) over DensDeck BaseGard SA (Self-Adhered) over DensDeck	.045 mil. min. RubberGard MAX	QuickSeam R.M.A. Strip Polymer Batten 114" rows, 6" o.c. QuickSeam R.M.A. Strip Heavy Duty Fasteners/Plates 114" rows, 6" o.c.	79891-0-0

EPDM MAX (QuickSeam R.M.A.) – Steel Deck – ISO/Cover Board (Attached) (Continued)

1-105 IF: 1 EF: A Slope: ¼"	Steel: Wide Rib 18ga/33ksi/54" span 20- 18ga/80ksi/72" span 22ga/80ksi/54" span	Insulation: ISO 95+ GL – 1"-12", 4'x8' boards ISO 95+ GL (Taper) – 1"-12", 4'x4' boards ISOGARD HD COMP – 1.4"-4", 4'x8' boards RESISTA – 1"-12", 4'x8' boards Structodek – ½", 4'x8' boards DensDeck – ¼" min., 4'x8' boards Securock – ¼" min., 4'x8' boards FiberTop B – ½", 4'x8' boards Attachment: Pre-securement Vapor Retarder (Optional): 4-6 min. poly V-Force (Self-Adhered) over DensDeck BaseGard SA (Self-Adhered) over DensDeck	.045 mil. min. RubberGard MAX	QuickSeam R.M.A. Strip Polymer Batten 114" rows, 6" o.c. QuickSeam R.M.A. Strip Heavy Duty Fasteners/Plates 114" rows, 6" o.c.	79900-0-0
1-105 IF: 1 EF: A Slope: ½"	Steel: Wide Rib 18ga/33ksi/54" span 20- 18ga/80ksi/72" span 22ga/80ksi/54" span	Insulation: Structodek – ½", 4'x8' boards DensDeck – ¼" min., 4'x8' boards Securock – ¼" min., 4'x8' boards Attachment: Pre-securement Vapor Retarder (Optional): 4-6 min. poly V-Force (Self-Adhered) over DensDeck BaseGard SA (Self-Adhered) over DensDeck	.045 mil. min. RubberGard MAX	QuickSeam R.M.A. Strip Heavy Duty Fasteners/ V- Plates 114" rows, 6" o.c.	80183-0-0
1-105 IF: 1 EF: A Slope: ½"	Steel: Wide Rib 18ga/33ksi/54" span 20- 18ga/80ksi/72" span 22ga/80ksi/54" span	Cover Board: Structodek – ½" min., 4'x8' boards DensDeck – ¼" min., 4'x8' boards Securock – ¼" min., 4'x8' boards Attachment: Pre-securement Insulation: ISO 95+ GL – 1"-12", 4'x8' boards ISO 95+ GL (Taper) – 1"-12", 4'x4' boards ISOGARD HD COMP – 1.4"-4", 4'x8' boards Attachment: Loose Laid Vapor Retarder (Optional): 4-6 min. poly V-Force (Self-Adhered) over DensDeck BaseGard SA (Self-Adhered) over DensDeck	.045 mil. min. RubberGard MAX	QuickSeam R.M.A. Strip Heavy Duty Fasteners/ V- Plates 114" rows, 6" o.c.	80187-0-0
1-105 IF: 1 EF: A Slope: ¼"	Steel: Wide Rib 18ga/33ksi/54" span 20- 18ga/80ksi/72" span 22ga/80ksi/54" span	Cover Board: ISOGARD HD – ½", 4'x8' boards Attachment: Pre-securement Insulation: ISO 95+ GL – 1"-12", 4'x8' boards ISO 95+ GL (Taper) – 1"-12", 4'x4' boards Attachment: Loose Laid Vapor Retarder (Optional): 4-6 min. poly V-Force (Self-Adhered) over DensDeck BaseGard SA (Self-Adhered) over DensDeck	.045 mil. min. RubberGard MAX	QuickSeam R.M.A. Strip Polymer Batten 114" rows, 6" o.c. QuickSeam R.M.A. Strip Heavy Duty Fasteners/Plates 114" rows, 6" o.c.	386867-0-0

EPDM MAX FR (QuickSeam R.M.A.) – Steel Deck – ISO/Cover Board (Attached)

Uplift	Deck	Cover Board / Insulation	Membrane	M Attachment	RoofNav
1-60 IF: 1 EF: A Slope: 2"	Steel: 20-16ga/33ksi/72" span 22ga/33ksi/60" span 22ga/80ksi/72" span	Insulation: ISO 95+ GL – 1"-12", 4'x8' boards ISO 95+ GL (Taper) – 1"-12", 4'x4' boards ISOGARD HD COMP – 1.4"-4", 4'x8' boards RESISTA – 1"-12", 4'x8' boards Attachment: Pre-securement Vapor Retarder (Optional): 4-6 min. poly V-Force (Self-Adhered) over DensDeck BaseGard SA (Self-Adhered) over DensDeck	.045 mil. min. RubberGard MAX FR	QuickSeam R.M.A. Strip Polymer Batten 114" rows, 6" o.c. QuickSeam R.M.A. Strip Heavy Duty Fasteners/ V- Plates 114" rows, 6" o.c. QuickSeam R.M.A. Strip Heavy Duty Fasteners/Plates 114" rows, 6" o.c.	80362-0-0

EPDM MAX FR (QuickSeam R.M.A.) – Steel Deck – ISO/Cover Board (Attached) (Continued)

<p>1-60 IF: 1 EF: A Slope: 3"</p>	<p>Steel: 20-16ga/33ksi/72" span 22ga/33ksi/60" span 22ga/80ksi/72" span</p>	<p>Cover Board: Structodek – ½" min., 4'x8' boards DensDeck – ¼" min., 4'x8' boards Securock – ¼" min., 4'x8' boards Attachment: Pre-securement Insulation: ISO 95+ GL – 1"-12", 4'x8' boards ISO 95+ GL (Taper) – 1"-12", 4'x4' boards ISOGARD HD COMP – 1.4"-4", 4'x8' boards RESISTA – 1"-12", 4'x8' boards Attachment: Loose Laid Vapor Retarder (Optional): 4-6 min. poly V-Force (Self-Adhered) over DensDeck BaseGard SA (Self-Adhered) over DensDeck</p>	<p>.045 mil. min. RubberGard MAX FR</p>	<p>QuickSeam R.M.A. Strip Polymer Batten 114" rows, 6" o.c. QuickSeam R.M.A. Strip Heavy Duty Fasteners/ V- Plates 114" rows, 6" o.c. QuickSeam R.M.A. Strip Heavy Duty Fasteners/Plates 114" rows, 6" o.c.</p>	<p>80398-0-0</p>
<p>1-90 IF: 1 EF: A Slope: 2"</p>	<p>Steel: 18-16ga/33ksi/72" span 20ga/33ksi/48" span 20g/80ksi/72" span 22ga/80ksi/72" span</p>	<p>Insulation: ISO 95+ GL – 1"-12", 4'x8' boards ISO 95+ GL (Taper) – 1"-12", 4'x4' boards ISOGARD HD COMP – 1.4"-4", 4'x8' boards RESISTA – 1"-12", 4'x8' boards Attachment: Pre-securement Vapor Retarder (Optional): 4-6 min. poly V-Force (Self-Adhered) over DensDeck BaseGard SA (Self-Adhered) over DensDeck</p>	<p>.045 mil. min. RubberGard MAX FR</p>	<p>QuickSeam R.M.A. Strip Polymer Batten 114" rows, 6" o.c. QuickSeam R.M.A. Strip Heavy Duty Fasteners/ V- Plates 114" rows, 6" o.c. QuickSeam R.M.A. Strip Heavy Duty Fasteners/Plates 114" rows, 6" o.c.</p>	<p>80346-0-0</p>
<p>1-90 IF: 1 EF: A Slope: 2"</p>	<p>Steel: 18-16ga/33ksi/72" span 20ga/33ksi/48" span 20g/80ksi/72" span 22ga/80ksi/72" span</p>	<p>Cover Board: ISOGARD HD – ½", 4'x8' boards Attachment: Pre-securement Insulation: ISO 95+ GL – 1"-12", 4'x8' boards ISO 95+ GL (Taper) – 1"-12", 4'x4' boards RESISTA – 1"-12", 4'x8' boards Attachment: Loose Laid Vapor Retarder (Optional): 4-6 min. poly V-Force (Self-Adhered) over DensDeck BaseGard SA (Self-Adhered) over DensDeck</p>	<p>.045 mil. min. RubberGard MAX FR</p>	<p>QuickSeam R.M.A. Strip Polymer Batten 114" rows, 6" o.c. QuickSeam R.M.A. Strip Heavy Duty Fasteners/ V- Plates 114" rows, 6" o.c. QuickSeam R.M.A. Strip Heavy Duty Fasteners/Plates 114" rows, 6" o.c.</p>	<p>386524-0-0</p>
<p>1-90 IF: 1 EF: A Slope: 3"</p>	<p>Steel: 18-16ga/33ksi/72" span 20ga/33ksi/48" span 20g/80ksi/72" span 22ga/80ksi/72" span</p>	<p>Insulation: Structodek – ½" min., 4'x8' boards DensDeck – ¼" min., 4'x8' boards Securock – ¼" min., 4'x8' boards Attachment: Pre-securement Vapor Retarder (Optional): 4-6 min. poly V-Force (Self-Adhered) over DensDeck BaseGard SA (Self-Adhered) over DensDeck</p>	<p>.045 mil. min. RubberGard MAX FR</p>	<p>QuickSeam R.M.A. Strip Polymer Batten 114" rows, 6" o.c. QuickSeam R.M.A. Strip Heavy Duty Fasteners/ V- Plates 114" rows, 6" o.c. QuickSeam R.M.A. Strip Heavy Duty Fasteners/Plates 114" rows, 6" o.c.</p>	<p>80410-0-0</p>
<p>1-90 IF: 1 EF: A Slope: 3"</p>	<p>Steel: 18-16ga/33ksi/72" span 20ga/33ksi/48" span 20g/80ksi/72" span 22ga/80ksi/72" span</p>	<p>Cover Board: Structodek – ½" min., 4'x8' boards DensDeck – ¼" min., 4'x8' boards Securock – ¼" min., 4'x8' boards Attachment: Pre-securement Insulation: ISO 95+ GL – 1"-12", 4'x8' boards ISO 95+ GL (Taper) – 1"-12", 4'x4' boards ISOGARD HD COMP – 1.4"-4", 4'x8' boards RESISTA – 1"-12", 4'x8' boards Attachment: Loose Laid Vapor Retarder (Optional): 4-6 min. poly V-Force (Self-Adhered) over DensDeck BaseGard SA (Self-Adhered) over DensDeck</p>	<p>.045 mil. min. RubberGard MAX FR</p>	<p>QuickSeam R.M.A. Strip Polymer Batten 114" rows, 6" o.c. QuickSeam R.M.A. Strip Heavy Duty Fasteners/ V- Plates 114" rows, 6" o.c. QuickSeam R.M.A. Strip Heavy Duty Fasteners/Plates 114" rows, 6" o.c.</p>	<p>80414-0-0</p>

EPDM MAX FR (QuickSeam R.M.A.) – Steel Deck – ISO/Cover Board (Attached) (Continued)

1-105 IF: 1 EF: A Slope: 3"	Steel: Wide Rib 18ga/33ksi/54" span 20- 18ga/80ksi/72" span 22ga/80ksi/54" span	Insulation: Structodek – ½" min., 4'x8' boards DensDeck – ¼" min., 4'x8' boards Securock – ¼" min., 4'x8' boards Attachment: Pre-securement Vapor Retarder (Optional): 4-6 min. poly V-Force (Self-Adhered) over DensDeck BaseGard SA (Self-Adhered) over DensDeck	.045 mil. min. RubberGard MAX FR	QuickSeam R.M.A. Strip Polymer Batten 114" rows, 6" o.c. QuickSeam R.M.A. Strip Heavy Duty Fasteners/ V- Plates 114" rows, 6" o.c. QuickSeam R.M.A. Strip Heavy Duty Fasteners/Plates 114" rows, 6" o.c.	80426-0-0
1-105 IF: 1 EF: A Slope: 3"	Steel: Wide Rib 18ga/33ksi/54" span 20- 18ga/80ksi/72" span 22ga/80ksi/54" span	Cover Board: Structodek – ½" min., 4'x8' boards DensDeck – ¼" min., 4'x8' boards Securock – ¼" min., 4'x8' boards Attachment: Pre-securement Insulation: ISO 95+ GL – 1"-12", 4'x8' boards ISO 95+ GL (Taper) – 1"-12", 4'x4' boards ISOGARD HD COMP – 1.4"-4", 4'x8' boards Attachment: Loose Laid Vapor Retarder (Optional): 4-6 min. poly V-Force (Self-Adhered) over DensDeck BaseGard SA (Self-Adhered) over DensDeck	.045 mil. min. RubberGard MAX FR	QuickSeam R.M.A. Strip Polymer Batten 114" rows, 6" o.c. QuickSeam R.M.A. Strip Heavy Duty Fasteners/ V- Plates 114" rows, 6" o.c. QuickSeam R.M.A. Strip Heavy Duty Fasteners/Plates 114" rows, 6" o.c.	80430-0-0
1-105 IF: 1 EF: A Slope: 2"	Steel: Wide Rib 18ga/33ksi/54" span 20- 18ga/80ksi/72" span 22ga/80ksi/54" span	Cover Board: ISOGARD HD – ½", 4'x8' boards Attachment: Pre-securement Insulation: ISO 95+ GL – 1"-12", 4'x8' boards ISO 95+ GL (Taper) – 1"-12", 4'x4' boards Attachment: Loose Laid Vapor Retarder (Optional): 4-6 min. poly V-Force (Self-Adhered) over DensDeck BaseGard SA (Self-Adhered) over DensDeck	.045 mil. min. RubberGard MAX FR	QuickSeam R.M.A. Strip Polymer Batten 114" rows, 6" o.c. QuickSeam R.M.A. Strip Heavy Duty Fasteners/ V-Plates 114" rows, 6" o.c. QuickSeam R.M.A. Strip Heavy Duty Fasteners/Plates 114" rows, 6" o.c.	386532-0-0
1-105 IF: 1 EF: A Slope: 2"	Steel: Wide Rib 18ga/33ksi/54" span 20- 18ga/80ksi/72" span 22ga/80ksi/54" span	Insulation: ISO 95+ GL – 1"-12", 4'x8' boards ISO 95+ GL (Taper) – 1"-12", 4'x4' boards ISOGARD HD COMP – 1.4"-4", 4'x8' boards Attachment: Loose Laid Vapor Retarder (Optional): 4-6 min. poly V-Force (Self-Adhered) over DensDeck BaseGard SA (Self-Adhered) over DensDeck	.045 mil. min. RubberGard MAX FR	QuickSeam R.M.A. Strip Polymer Batten 114" rows, 6" o.c. QuickSeam R.M.A. Strip Heavy Duty Fasteners/ V-Plates 114" rows, 6" o.c. QuickSeam R.M.A. Strip Heavy Duty Fasteners/Plates 114" rows, 6" o.c.	80354-0-0

Platinum EPDM (Attached) – Steel Deck – ISO/Cover Board (Attached)

Uplift	Deck	Cover Board / Insulation	Membrane	M Attachment	RoofNav
1-60 IF: 1 EF: A Slope: ½"	Steel 22-16 ga 33 ksi 72" span	Insulation: ISO 95+ GL – 1.5"-12", 4'x8' boards ISO 95+ GL (Taper) – 1.5"-12", 4'x8' boards RESISTA – 1.5"-12", 4'x8' boards DensDeck – ¼" min. – 4'x8' boards Securock – ¼" min. – 4'x8' boards Attachment: Pre-securement Vapor Retarder (Optional): 4-6 min. poly V-Force (Self-Adhered) over DensDeck BaseGard SA (Self-Adhered) over DensDeck	.090 mil. RubberGard Platinum .090 mil. RubberGard Platinum PT	72" rows at 6" o.c. HD Fasteners and Metal or Polymer Batten Strip and HD Fasteners	78504-0-0

Platinum EPDM (Attached) – Steel Deck – ISO/Cover Board (Attached) (Continued)

1-60 IF: 1 EF: A Slope: 1.5"	Steel 22-16 ga 33 ksi 72" span	Insulation: ISO 95+ GL – 1.5"-12", 4'x8' boards ISO 95+ GL (Taper) – 1.5"-12", 4'x8' boards RESISTA – 1.5"-12", 4'x8' boards ISOGARD HD COMP – 1.4"-4", 4'x8' boards Structodek – ½" min. – 4'x8' boards DensDeck – ¼" min. – 4'x8' boards Securock – ¼" min. – 4'x8' boards Attachment: Pre-securement Vapor Retarder (Optional): 4-6 min. poly V-Force (Self-Adhered) over DensDeck BaseGard SA (Self-Adhered) over DensDeck	.090 mil. RubberGard Platinum .090 mil. RubberGard Platinum PT	84" rows at 6" o.c. HD Fasteners and Metal or Polymer Batten Strip and HD Fasteners	125220-0-0
1-60 IF: 1 EF: A Slope: 1.5"	Steel 22-16 ga 33 ksi 72" span	Insulation: ISO 95+ GL – 1"-12", 4'x8' boards ISO 95+ GL (Taper) – 1"-12", 4'x8' boards RESISTA – 1"-12", 4'x8' boards Attachment: Pre-securement	.090 mil. RubberGard Platinum .090 mil. RubberGard Platinum PT	84" rows at 6" o.c. QuickSeam R.M.A. Strip w/ Metal or Polymer Batten Strip and HD Fasteners	181910-0-0
1-60 IF: 1 EF: A Slope: 1.5"	Steel 22-16 ga 33 ksi 72" span	Insulation: ISO 95+ GL – 1"-12", 4'x8' boards ISO 95+ GL (Taper) – 1"-12", 4'x8' boards RESISTA – 1"-12", 4'x8' boards Attachment: Pre-securement	.090 mil. RubberGard Platinum .090 mil. RubberGard Platinum PT	96" rows at 12" o.c. QuickSeam R.M.A. Strip w/ Metal Batten Strip and HD Fasteners	181927-0-0
1-60 IF: 1 EF: A Slope: 1.5"	Steel 22-16 ga 33 ksi 72" span	Insulation: ISO 95+ GL – 1"-12", 4'x8' boards ISO 95+ GL (Taper) – 1"-12", 4'x8' boards RESISTA – 1"-12", 4'x8' boards Attachment: Pre-securement	.090 mil. RubberGard Platinum .090 mil. RubberGard Platinum PT	84" rows at 12" o.c. HD Fasteners and Metal Batten Strip and HD Fasteners	196547-0-0
1-60 IF: 1 EF: A Slope: 1.5"	Steel 20ga/33ksi/72" span 22ga/33ksi/60" span	Insulation: ISO 95+ GL – 1.5"-12", 4'x8' boards ISO 95+ GL (Taper) – 1.5"-12", 4'x8' boards RESISTA – 1.5"-12", 4'x8' boards Attachment: Pre-securement	.090 mil. RubberGard Platinum .090 mil. RubberGard Platinum PT	114" rows at 12" o.c. HD Fasteners and Poly Batten Strip and HD Plus Fasteners	335012-0-0
1-75 IF: 1 EF: A Slope: ½"	Steel 22-16 ga 33 ksi 72" span	Insulation: ISO 95+ GL – 1"-12", 4'x8' boards ISO 95+ GL (Taper) – 1"-12", 4'x8' boards RESISTA – 1"-12", 4'x8' boards Attachment: Pre-securement	.090 mil. RubberGard Platinum .090 mil. RubberGard Platinum PT	72" rows at 12" o.c. QuickSeam R.M.A. Strip w/ Metal or Polymer Batten Strip and HD Fasteners	181941-0-0
1-90 IF: 1 EF: A Slope: ½"	Steel 18-16ga/33ksi/72" span 20ga/33ksi/48" span 20ga/80ksi/72" span 22ga/80ksi/72" span	Insulation: ISO 95+ GL – 1.5"-12", 4'x8' boards ISO 95+ GL (Taper) – 1.5"-12", 4'x8' boards RESISTA – 1.5"-12", 4'x8' boards Attachment: Pre-securement Vapor Retarder (Optional): 4-6 min. poly V-Force (Self-Adhered) over DensDeck BaseGard SA (Self-Adhered) over DensDeck	.090 mil. RubberGard Platinum .090 mil. RubberGard Platinum PT	114" rows at 12" o.c. HD Fasteners and Poly Batten Strip and HD Plus Fasteners	230418-0-0

Metal Building Re-Cover (Insulated) – EPDM MAX (RMA/Batten Attached) – ISO/Cover Board (Attached)

Uplift	Insulation	Insulation Attachment	Membrane	RoofNav	
105 PSF Slope: ¼" IF: 1 EF: A Hail: SH	Insulation (Top): ½" - 1" thick ISO 95+ GL or Resista (F/T) Insulation (Flute): Min. 1" ISO 95+ GL Max thickness not to exceed the SSR rib or corrugation.	Insulation (Top): Presecurement (FM LPDS 1-29) Insulation (Flute): Loose Laid	Membrane: Min. 45 mil. RubberGard MAX or MAX PT Attachment: QuickSeam R.M.A. Strip 10' rows, 6" o.c. Polymer Batten Strip Purlin Fastener	304997-0-0	
	Insulation (Top): ½" thick ISOGARD HD Insulation (Flute): Min. 1" ISO 95+ GL Max thickness not to exceed the SSR rib or corrugation.			Cover Board: ¼" min. DensDeck, DensDeck Prime or Securock	Insulation (Top): CF
	Insulation (Top): ½" - 1" thick ISO 95+ GL (F/T) Insulation (Flute): Min. 1" ISO 95+ GL Max thickness not to exceed the SSR rib or corrugation.	Insulation (Top): Presecurement (FM LPDS 1-29)	Insulation (Top): CF Insulation (Flute): Loose Laid		386974-0-0
	Cover Board: ½" thick ISOGARD HD Insulation (Flute): Min. 1" ISO 95+ GL Max thickness not to exceed the SSR rib or corrugation.	Cover Board: Presecurement (FM LPDS 1-29)	Insulation (Flute): Loose Laid	Membrane: Min. 45 mil. RubberGard MAX or MAX PT Attachment: QuickSeam R.M.A. Strip 10' rows, 6" o.c. Polymer Batten Strip Purlin Fastener	304999-0-0
105 PSF Slope: 2.5" IF: 1 EF: A Hail: SH	Insulation (Top): ½" - 1" thick ISO 95+ GL (F/T) Insulation (Flute): Min. 1" ISO 95+ GL Max thickness not to exceed the SSR rib or corrugation.	Insulation (Top): Presecurement (FM LPDS 1-29) Insulation (Flute): Loose Laid	Membrane: Min. 45 mil. RubberGard MAX FR Attachment: QuickSeam R.M.A. Strip 10' rows, 6" o.c. Polymer Batten Strip Purlin Fastener	305000-0-0	
	Cover Board: ¼" min. DensDeck, DensDeck Prime or Securock Insulation (Flute): Min. 1" ISO 95+ GL Max thickness not to exceed the SSR rib or corrugation.	Cover Board: Presecurement (FM LPDS 1-29)		Insulation (Flute): Loose Laid	305002-0-0
105 PSF Slope: 3" IF: 1 EF: A Hail: SH	Cover Board: ¼" min. Securock Insulation (Flute): Min. 1" ISO 95+ GL Max thickness not to exceed the SSR rib or corrugation.	Cover Board: Presecurement (FM LPDS 1-29) Insulation (Flute): Loose Laid	Membrane: Min. 45 mil. RubberGard MAX FR Attachment: QuickSeam R.M.A. Strip 10' rows, 6" o.c. Polymer Batten Strip Purlin Fastener	312633-0-0	
105 PSF Slope: ¼" IF: 1 EF: A Hail: SH	Insulation (Top): ½" - 4" thick ISO 95+ GL or Resista (F/T) Insulation (Flute): Min. 1" ISO 95+ GL Max thickness not to exceed the SSR rib or corrugation.	Insulation (Top): Presecurement (FM LPDS 1-29) Insulation (Flute): Loose Laid	Membrane: Min. 45 mil. RubberGard MAX or MAX PT Attachment: QuickSeam R.M.A. Strip 114" rows, 6" o.c. Metal Batten Strip Purlin Fastener	423013-0-0	

Metal Building Re-Cover (Un-Insulated) – EPDM MAX (RMA/Batten Attached) – ISO/Cover Board (Attached)

Uplift	Insulation	Insulation Attachment	Membrane	RoofNav
60 PSF Slope: 1/2" IF: 1 EF: A Hail: SH	Cover Board: 1/2" Structodek; 1/4" min. DensDeck, DensDeck Prime or Securock Insulation (Flute): 1" - 12" ISO 95+ GL Max thickness not to exceed 12"	Cover Board: Presecurement (FM LPDS 1-29) Insulation (Flute): Loose Laid	Membrane: Min. 45 mil. RubberGard MAX or MAX PT Attachment: QuickSeam R.M.A. Strip 8' rows, 12" o.c. Metal Batten Strip Purlin Fastener	304997-0-0
60 PSF Slope: 1/4" IF: 1 EF: A Hail: SH	Cover Board: 1/2" ISOGARD HD Insulation (Flute): 1" - 12" ISO 95+ GL Max thickness not to exceed 12"			427686-0-0
60 PSF Slope: 1/4" IF: 1 EF: A Hail: SH	Insulation: 1/2" ISOGARD HD Insulation (Flute): Min. 1" ISO 95+ GL Max thickness not to exceed the SSR rib or corrugation	Insulation (Top): Presecurement (FM LPDS 1-29) Insulation (Flute): Loose Laid	Membrane: Min. 45 mil. RubberGard MAX or MAX PT Attachment: QuickSeam R.M.A. Strip 8' rows, 12" o.c. Metal Batten Strip Purlin Fastener	427713-0-0
75 PSF Slope: 1/4" IF: 1 EF: A Hail: SH	Insulation: 1/2" ISOGARD HD Insulation (Flute): Min. 1" ISO 95+ GL Max thickness not to exceed the SSR rib or corrugation	Insulation (Top): Presecurement (FM LPDS 1-29) Insulation (Flute): Loose Laid	Membrane: Min. 45 mil. RubberGard MAX or MAX PT Attachment: QuickSeam R.M.A. Strip 72" rows, 12" o.c. Metal Batten Strip Purlin Fastener	427715-0-0
75 PSF Slope: 1/4" IF: 1 EF: A Hail: SH	Cover Board: 1/2" ISOGARD HD Insulation (Flute): 1" - 12" ISO 95+ GL Max thickness not to exceed 12"	Cover Board: Presecurement (FM LPDS 1-29) Insulation (Flute): Loose Laid	Membrane: Min. 45 mil. RubberGard MAX or MAX PT Attachment: QuickSeam R.M.A. Strip 72" rows, 12" o.c. Metal Batten Strip Purlin Fastener	427688-0-0
75 PSF Slope: 1/2" IF: 1 EF: A Hail: SH	Cover Board: 1/2" Structodek; 1/4" min. DensDeck, DensDeck Prime or Securock Insulation (Flute): 1" - 12" ISO 95+ GL Max thickness not to exceed 12"	Cover Board: Presecurement (FM LPDS 1-29) Insulation (Flute): Loose Laid	Membrane: Min. 60 mil. RubberGard MAX or MAX PT Attachment: QuickSeam R.M.A. Strip 72" rows, 12" o.c. Metal Batten Strip Purlin Fastener	427663-0-0
90 PSF Slope: 1/4" IF: 1 EF: A Hail: SH	Cover Board: 1/2" ISOGARD HD Insulation (Flute): 1" - 12" ISO 95+ GL Max thickness not to exceed 12"	Cover Board: Presecurement (FM LPDS 1-29) Insulation (Flute): Loose Laid	Membrane: Min. 45 mil. RubberGard MAX or MAX PT Attachment: QuickSeam R.M.A. Strip 114" rows, 6" o.c. Metal Batten Strip Purlin Fastener	427072-0-0
90 PSF Slope: 1/4" IF: 1 EF: A Hail: SH	Insulation: 1/2" ISOGARD HD Insulation (Flute): Min. 1" ISO 95+ GL Max thickness not to exceed the SSR rib or corrugation	Insulation (Top): Presecurement (FM LPDS 1-29) Insulation (Flute): Loose Laid	Membrane: Min. 45 mil. RubberGard MAX or MAX PT Attachment: QuickSeam R.M.A. Strip 114" rows, 6" o.c. Metal Batten Strip Purlin Fastener	427074-0-0
90 PSF Slope: 1/2" IF: 1 EF: A Hail: SH	Cover Board: 1/2" Structodek; 1/4" min. DensDeck, DensDeck Prime or Securock Insulation (Flute): 1" - 12" ISO 95+ GL Max thickness not to exceed 12"	Cover Board: Presecurement (FM LPDS 1-29) Insulation (Flute): Loose Laid	Membrane: Min. 45 mil. RubberGard MAX or MAX PT Attachment: QuickSeam R.M.A. Strip 114" rows, 6" o.c. Metal Batten Strip Purlin Fastener	427070-0-0

Metal Building Re-Cover (Un-Insulated) – EPDM MAX (RMA/Plate and Fastener Attached) – ISO/Cover Board (Attached)

Uplift	Insulation	Insulation Attachment	Membrane	RoofNav
60 PSF Slope: ¼" IF: 1 EF: A Hail: SH	Cover Board: ½" ISOGARD HD Insulation (Flute): 1" - 12" ISO 95+ GL/Resista Max thickness not to exceed 12"	Cover Board: Presecurement (FM LPDS 1-29) Insulation (Flute): Loose Laid	Membrane: Min. 60 mil. RubberGard MAX or MAX PT Attachment: QuickSeam R.M.A. Strip 5' rows, 12" o.c. HD Seam Plate and Purlin Fastener	427692-0-0
60 PSF Slope: ½" IF: 1 EF: A Hail: SH	Cover Board: ½" Structodek; ¼" min. DensDeck, DensDeck Prime or Securock Insulation (Flute): 1" - 12" ISO 95+ GL/Resista Max thickness not to exceed 12"	Cover Board: Presecurement (FM LPDS 1-29) Insulation (Flute): Loose Laid	Membrane: Min. 45 mil. RubberGard MAX or MAX PT Attachment: QuickSeam R.M.A. Strip 5' rows, 12" o.c. HD Seam Plate and Purlin Fastener	427679-0-0

Metal Building Re-Cover (Un-Insulated) – EPDM MAX (Batten and Fastener Attached) – ISO/Cover Board (Attached)

Uplift	Insulation	Insulation Attachment	Membrane	RoofNav
60 PSF Slope: ½" IF: 1 EF: A Hail: SH	Cover Board: ½" Structodek; ¼" min. DensDeck, DensDeck Prime or Securock Insulation (Flute): 1" - 12" ISO 95+ GL/Resista Max thickness not to exceed 12"	Cover Board: Presecurement (FM LPDS 1-29) Insulation (Flute): Loose Laid	Membrane: Min. 45 mil. RubberGard MAX or MAX PT Attachment: Metal Batten Strip, 84" rows, 12" o.c. HD Seam Plate Purlin Fastener	427667-0-0
60 PSF Slope: ¼" IF: 1 EF: A Hail: SH	Cover Board: ½" ISOGARD HD Insulation (Flute): 1" - 12" ISO 95+ GL/Resista Max thickness not to exceed 12"	Cover Board: Presecurement (FM LPDS 1-29) Insulation (Flute): Loose Laid	Membrane: Min. 45 mil. RubberGard MAX or MAX PT Attachment: Metal Batten Strip, 84" rows, 12" o.c. HD Seam Plate Purlin Fastener	427702-0-0
60 PSF Slope: ¼" IF: 1 EF: A Hail: SH	Insulation: ½" ISOGARD HD Insulation (Flute): Min. 1" ISO 95+ GL Max thickness not to exceed the SSR rib or corrugation	Insulation: Presecurement (FM LPDS 1-29) Insulation (Flute): Loose Laid	Membrane: Min. 45 mil. RubberGard MAX or MAX PT Attachment: Metal Batten Strip, 84" rows, 12" o.c. HD Seam Plate Purlin Fastener	427728-0-0
105 PSF Slope: ½" IF: 1 EF: A Hail: SH	Cover Board: ½" Structodek; ¼" min. DensDeck, DensDeck Prime or Securock Insulation (Flute): 1" - 12" ISO 95+ GL/Resista Max thickness not to exceed 12"	Cover Board: Presecurement (FM LPDS 1-29) Insulation (Flute): Loose Laid	Membrane: Min. 45 mil. RubberGard MAX or MAX PT Attachment: Polymer Batten Strip, 84" rows, 6" o.c. Purlin Fastener	427670-0-0
105 PSF Slope: ¼" IF: 1 EF: A Hail: SH	Cover Board: ½" ISOGARD HD Insulation (Flute): 1" - 12" ISO 95+ GL/Resista Max thickness not to exceed 12"	Cover Board: Presecurement (FM LPDS 1-29) Insulation (Flute): Loose Laid	Membrane: Min. 45 mil. RubberGard MAX or MAX PT Attachment: Polymer Batten Strip, 84" rows, 6" o.c. Purlin Fastener	427706-0-0
105 PSF Slope: ¼" IF: 1 EF: A Hail: SH	Insulation: ½" ISOGARD HD Insulation (Flute): Min. 1" ISO 95+ GL Max thickness not to exceed the SSR rib or corrugation	Insulation: Presecurement (FM LPDS 1-29) Insulation (Flute): Loose Laid	Membrane: Min. 45 mil. RubberGard MAX or MAX PT Attachment: Polymer Batten Strip, 84" rows, 6" o.c. Purlin Fastener	427731-0-0

Metal Building Re-Cover (Un-Insulated) – EPDM MAX (Batten and Fastener Attached) – ISO/Cover Board (Attached) (Continued)

135 PSF Slope: ¼" IF: 1 EF: A Hail: SH	Insulation: ½" ISOGARD HD Insulation (Flute): Min. 1" ISO 95+ GL Max thickness not to exceed the SSR rib or corrugation	Insulation: Presecurement (FM LPDS 1-29) Insulation (Flute): Loose Laid	Membrane: Min. 45 mil. RubberGard MAX or MAX PT Attachment: Metal Batten Strip 84" rows, 6" o.c. Purlin Fastener	427734-0-0
135 PSF Slope: ¼" IF: 1 EF: A Hail: SH	Cover Board: ½" ISOGARD HD Insulation (Flute): 1" - 12" ISO 95+ GL/Resista Max thickness not to exceed 12"	Cover Board: Presecurement (FM LPDS 1-29) Insulation (Flute): Loose Laid	Membrane: Min. 45 mil. RubberGard MAX or MAX PT Attachment: Metal Batten Strip 84" rows, 6" o.c. Purlin Fastener	427709-0-0
135 PSF Slope: ½" IF: 1 EF: A Hail: SH	Cover Board: ½" Structodek; ¼" min. DensDeck, DensDeck Prime or Securock Insulation (Flute): 1" - 12" ISO 95+ GL/Resista Max thickness not to exceed 12"	Cover Board: Presecurement (FM LPDS 1-29) Insulation (Flute): Loose Laid	Membrane: Min. 45 mil. RubberGard MAX or MAX PT Attachment: Metal Batten Strip 84" rows, 6" o.c. Purlin Fastener	427674-0-0

Metal Building Re-Cover (Un-Insulated) – EPDM MAX (Plate and Fastener Attached) – ISO/Cover Board (Attached)

Uplift	Insulation	Insulation Attachment	Membrane	RoofNav
105 PSF Slope: ¼" IF: 1 EF: A Hail: SH	Insulation (Top): ½" - 4" ISO 95+ GL or Resista (F/T) Insulation (Flute): Min. 1" - 4" ISO 95+ GL or Resista Max thickness not to exceed the SSR rib or corrugation	Insulation: Presecurement (FM LPDS 1-29) Insulation (Flute): Loose Laid	Membrane: Min. 45 mil. RubberGard MAX Attachment: Metal Batten Strip, 84" rows, 6" o.c. HD Seam Plate and Purlin Fastener	423011-0-0
			Membrane: Min. 60 mil. RubberGard MAX Attachment: Metal Batten Strip, 114" rows, 6" o.c. HD Seam Plate and Purlin Fastener	422822-0-0

Factory Mutual Ballast Guidelines

Stone Ballast

ASTM D448 – Standard Size No. 3 for Coarse Aggregate (nominal 1 to 2 in. [25 to 50 mm] diameter). This standard permits amounts (by weight percent) to pass through the square sieve openings as shown in the table below.

Gradation for No. 3 Stone							
Size Number	Nominal Size in. (mm)	Sieve Opening in. (mm)					
		2 ½ (63)	2 (50)	1 ½ (38)	1 (25)	¾ (19)	½ (13)
3	1 to 2 (25 - 50)	100	90 to 100	35 to 70	0 to 15	---	0 to 5

Per FM Global Loss Prevention Data Sheet 1-29:

Please refer to this LPDS for full FM requirements as they relate to ballasted roofing systems.

2.2.10.17.1 FM Approvals does not Approve ballasted systems. If a ballasted system is to be used, select components that are FM Approved for use together as shown in a specific RoofNav assembly. In lieu of fasteners or adhesives used to secure above-deck components, use ballast in accordance with this data sheet to provide wind resistance.

- Do not use any aggregate surfacing, such as pea gravel or slag surfacing or crushed stone, in (a) regions prone to tropical cyclones and where the wind speed per D.S. 1-28 is ≥ 100 mph (≥ 45 m/s), or (b) in other regions on

buildings taller than that defined in Table 7. Where added protection for the roof cover is needed, such as near major fire walls, concrete paver blocks can be used.

- Do not use stone-ballasted roofs on the following:
 - Buildings taller than 150' (46 m)
 - In areas prone to tropical cyclones
 - In areas with design wind speeds \geq 100 mph (45 m/s) (see Data Sheet 1-28, Wind Design)
 - Beyond the acceptable limits shown in Tables 12 and 13

NOTE: These limitations do not apply to paver ballasted systems.

Perimeter and Corners on ballast roof:

For ballast application only, the roof perimeter and corner dimensions should be equal to at least 40% of the mean roof height, but not less than 8.5' (2.6 m) or 4% of the lesser plan dimension.

- Have the load capacity of the roof verified by a registered civil or structural engineer. The structure must be capable of supporting the dead weight of the roof system and ballast considering other gravity loads, without creating or aggravating a ponding problem.
- Ensure the roof slope is no more than 10°, 2"/ft (167 mm/m).

Ballast Weight:

Table 12. Weight Needed of No. 3 Round Stone Ballast, Parapet \leq 36 in. (914 mm)

Uplift Pressure (psf) Data Sheet 1-28	Ballast Weight, (psf)					
	Steel or Pre-Cast Panel Deck			Cementitious Wet Fill Deck		
	Field	Peri.	Cors.	Field	Peri.	Cors.
\leq 20	10	12	15	10	10	10
21 to 25	12	15	15	10	12	12
26 to 30	12	15	18	12	12	15
31 to 35	Use FM Approved 1-90 System			12	15	18
36 to 45	Use FM Approved 1-90 System			Use FM Approved 1-90 System		

Table 13. Weight Needed of No. 3 Round Stone Ballast, Parapet $>$ 36 in. (914 mm)

Uplift Pressure (psf) Data Sheet 1-28	Ballast Weight, psf					
	Steel or Pre-Cast Panel Deck			Cementitious Wet Fill Deck		
	Field	Peri.	Cors.	Field	Peri.	Cors.
\leq 20	10	10	12	10	10	10
21 to 25	12	12	12	10	10	12
26 to 30	12	12	15	12	12	12
31 to 35	12	15	18	12	12	15
36 to 45	Use FM Approved 1-90 System			15	15	18

NOTE:

1. For all tables, to convert to kg/m², multiply by 4.88.
2. Uplift pressure is determined from Data Sheet 1-28, Wind Design, and is not factored.
3. Paver Weight requirements can be found in LPDS 1-29.

This guide is meant to highlight Elevate products and specifications provided by Holcim Solutions & Products US, LLC and is subject to change without notice. Holcim takes responsibility for furnishing quality materials which meet published Elevate product specifications or other technical documents, subject to normal roof manufacturing tolerances. Neither Holcim nor its representatives practice architecture. Holcim Solutions & Products US, LLC offers no opinion on and expressly disclaims any responsibility for the soundness of any structure. Holcim accepts no liability for structural failure or resultant damages. Consult a competent structural engineer prior to installation if the structural soundness or structural ability to properly support a planned installation is in question. No Holcim representative is authorized to vary this disclaimer.