

Varying Movement Leg Dimensions Guide

LEG DIMENSIONS FOR VARYING MOVEMENTS - COMPRESSION AND/OR EXTENSION

COMPRESSION ↓	Downward movement of the roof or floor deck • Joint compression due to dead loads, live loads, snow loads, etc.
EXTENSION ↑	Upward movement of the roof or floor deck • Joint opens larger than installed width due to negative air pressure (roof lift) or the deck beneath compressing
DEFLECTION ↔	Both downward (compression) and upward (extension) movement • Most joints are subjected to movment in both directions For example, a joint required to handle 2" of compression and 1" of extension would have a 3" deflection

SHADOWLINE PROFILE

1" Deflection

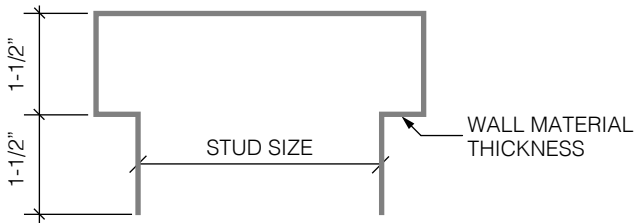

2" Deflection

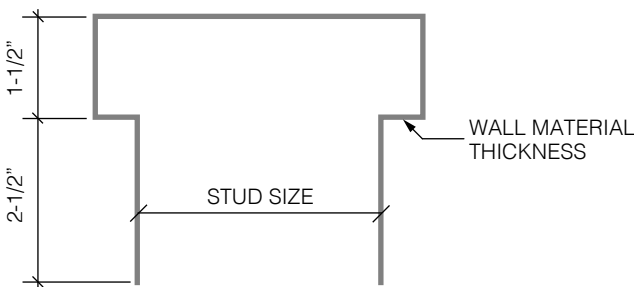

3" Deflection (Clips Required)

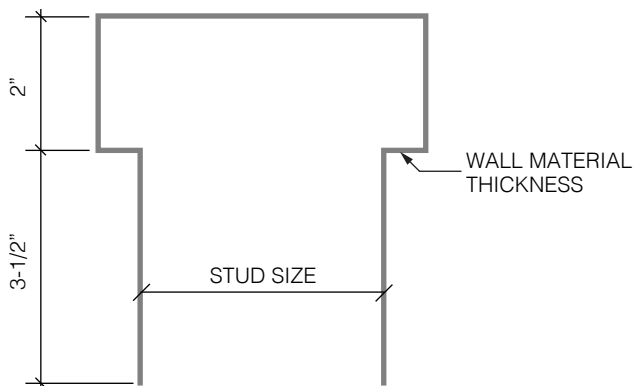

CAVITY SHADOWLINE PROFILE

1" Deflection

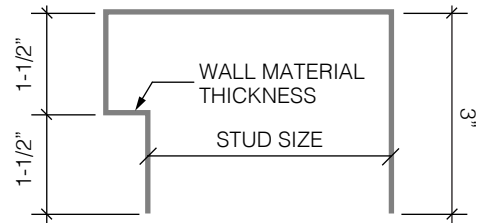

2" Deflection

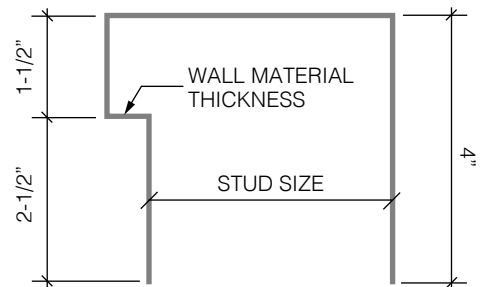

3" Deflection (Clips Required)

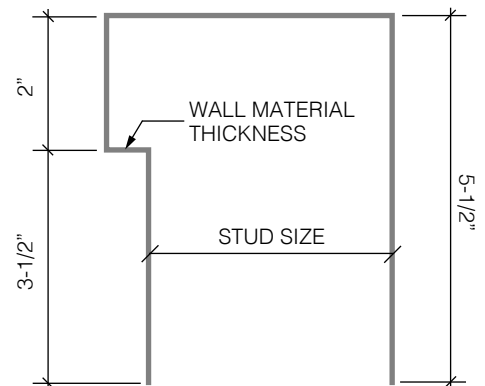

SHADOWLINE PROFILE

4" Deflection (Clips Required)

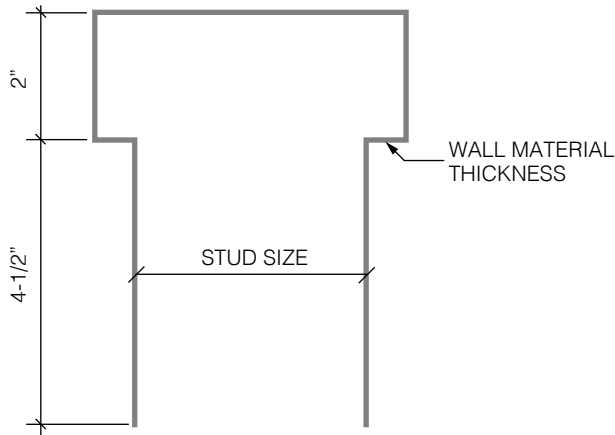

5" Deflection (Clips Required)

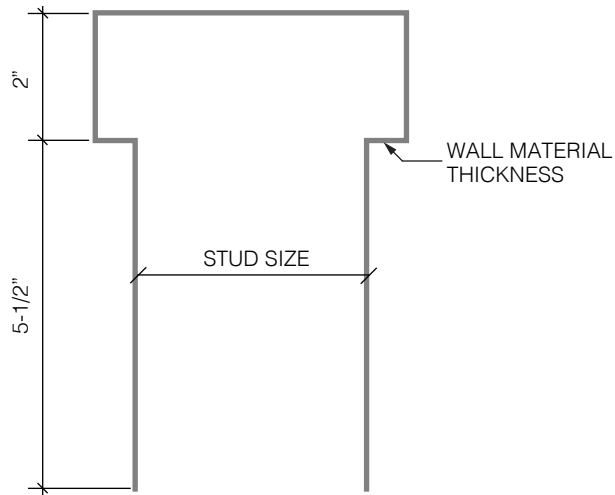

6" Deflection (Clips Required)

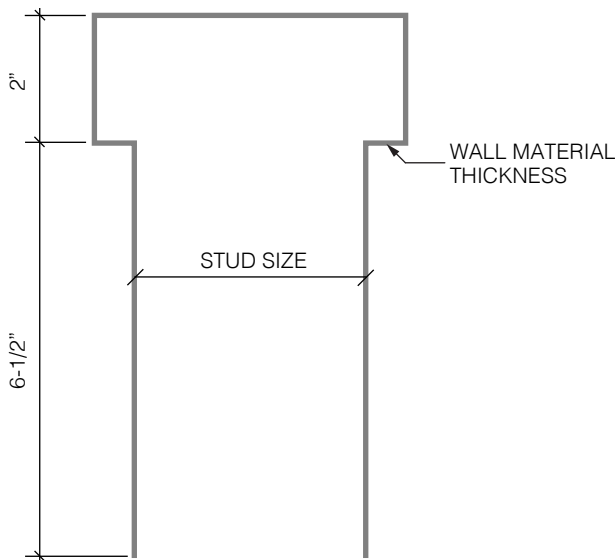

CAVITY SHADOWLINE PROFILE

4" Deflection (Clips Required)

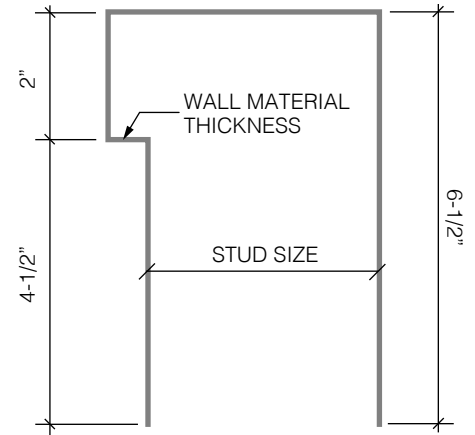

5" Deflection (Clips Required)

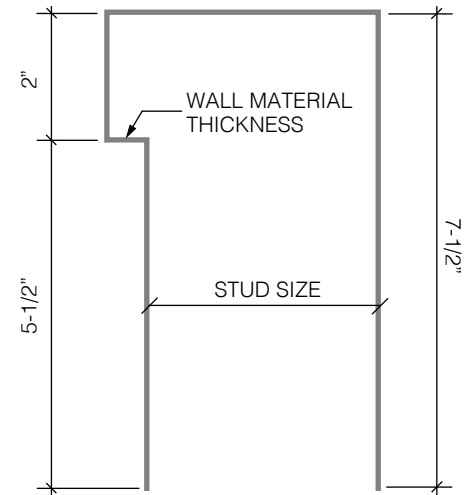

6" Deflection (Clips Required)

