



 Georgia-Pacific

DensGlass®
Shaftliner for Shaftwall/Stairwell Systems

TECHNICAL GUIDE

SHAFTLINER FOR SHAFTWALL/STAIRWELL SYSTEMS



Product Overview

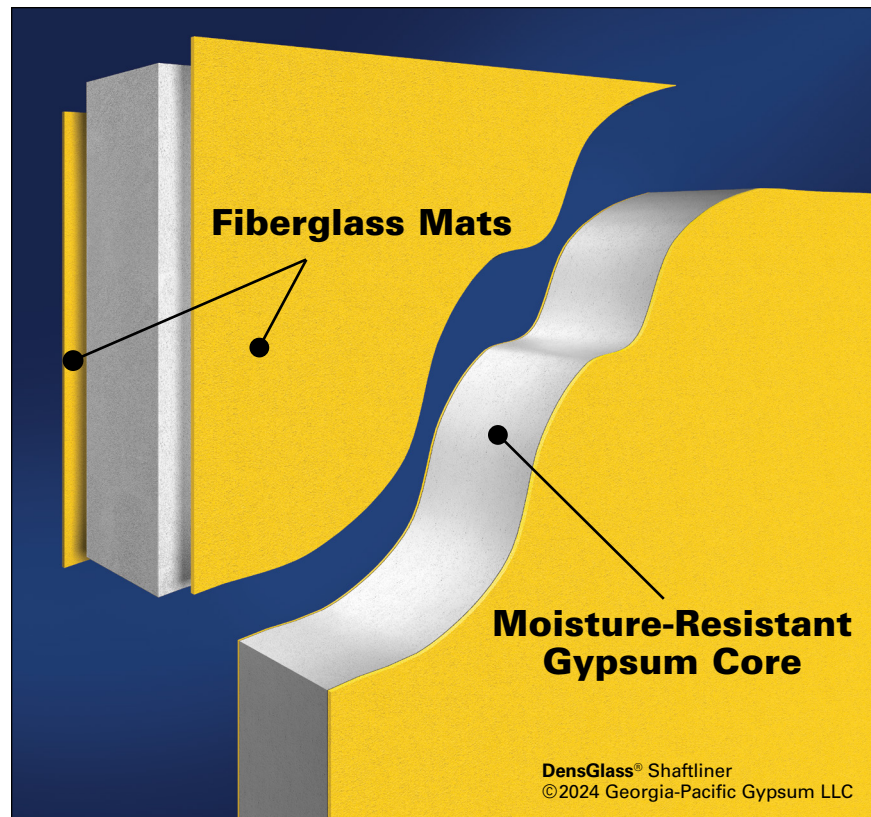

Table of Contents

<i>Product Overview</i>	2
<i>Sustainability</i>	4
<i>Installation Instructions</i>	5
<i>Recommendations</i>	6
<i>Design Summary Vertical</i>	7
<i>Design Summary Horizontal</i>	12
<i>Maximum Horizontal Spans</i>	13
<i>2-Hour Vertical and Horizontal Shaftwalls Around Horizontal Membranes and Ducts</i>	13
<i>Hoistway Enclosures</i>	14
<i>Sound Chart</i>	14
<i>Limiting Heights</i>	15
<i>Maximum Section Properties</i>	15
<i>Door Frame Details</i>	16
<i>Wall Frame Details</i>	17
<i>Rails/Chute/Beam Details</i>	18
<i>HVAC Duct Detail</i>	19
<i>Delivery, Handling and Storage</i>	19
<i>Recommendations and Limitations for Use</i>	19

DensGlass® Shaftliner Overview

In buildings around the world, our lightweight, maintenance-free gypsum shaftwall/stairwell enclosures serve as the perfect alternative for heavy masonry construction in building cores. In addition, DensGlass® Shaftliner shaftwall/stairwell assemblies save space, go up quickly and don't delay construction during cold weather.

Space-saving DensGlass® Shaftliner shaftwall/stairwell enclosures are designed for elevator and air shafts, stairwells and mechanical rooms in industrial buildings where greater wall heights are common, and as firewalls between office, warehouse and manufacturing areas. They are also used as horizontal membranes for corridor and stairway ceilings and under mechanical equipment where fire ratings are required and normal suspension support may be difficult.

DensGlass® Shaftliner has fiberglass mats for superior mold and moisture resistance compared to paper-faced shaftliners.

- Fiberglass mats eliminate a potential food source for mold and may reduce remediation and scheduling delays associated with paper-faced shaftliners.
- Replaces traditional paper-faced shaftliner.
- Backed with a limited warranty against delamination and deterioration for up to 12 months of exposure to normal weather conditions.¹

¹ For complete warranty details, visit www.buildgp.com/warranties.

Product Overview continued

Mold Resistance

When tested, as manufactured, DensGlass® Shaftliner panels scored a 10, the highest level of performance for mold resistance per ASTM D3273 Standard Test Method for Resistance to Growth of Mold on the Surface of Interior Coatings in an Environmental Chamber.

The score of 10 in the ASTM D3273 test indicates no mold growth in a 4-week controlled laboratory test. The mold resistance of any building product when used in actual job site conditions may not produce the same results as were achieved in the controlled, laboratory setting. No material can be considered mold proof. When properly used with good design, handling and construction practices, Dens® Gypsum Products provide increased mold resistance compared to standard paper-faced wallboard. For additional information, go to www.buildgp.com/safetyinfo.

DensGlass® Shaftliner is listed as mold resistant in UL Environment's Sustainable Product Guide. This validation means DensGlass® Shaftliner, which features fiberglass facings instead of paper facings, resists mold growth. The microbial-resistant test is based on ASTM D6329 Standard Guide for Developing Methodology for Evaluating the Ability of Indoor Materials to Support Microbial Growth Using Static Environmental Chambers, a testing standard set by ASTM International, an agency which develops testing guidelines and procedures for building materials, products, systems and services.

Easy Installation

Because the shaftwall assemblies are built from one side only, there's no need to access the inside of the shaft. The strong, C-T, C-H or I steel framing goes up quickly. Most configurations require only two steel components and two types of gypsum board. That makes these systems ideal for furred chases and interior partitions where fire ratings are required for exterior walls and access is restricted. Engineered for durability, these systems withstand air-pressure surges of high-speed elevators as well as lateral impact of stairway doors.

Built-In Economy

Gypsum shaftwall/stairwell systems typically cost less than masonry alternatives. Contractors also save money because the shaftwall/stairwell enclosures don't require expensive structural framing or concrete construction.

Reliable Steel Components

The two primary framing components in the DensGlass® Shaftliner shaftwall/stairwell system are slotted C-T, C-H or I studs and J tracks, manufactured from galvanized steel that meets ASTM C645 and AISI S200 standards for nonstructural steel framing and ASTM C653/A924 standards for galvanized steel framing for hot dip process.

The 2-1/2 in. (64 mm) steel framing system retains the popular 3-1/2 in. (89 mm) wall thickness with a two-hour fire rating (see pages 7 and 8) to accommodate standard door framing dimensions. The steel stud offers a unique feature—slotting in the web of the stud. Tests have demonstrated that these slots effectively improve resistance to thermal and noise transmissions.

The 2-1/2 in. (64 mm) stud provides a 1-1/2 in. (38 mm) air cavity for services. Studs are fitted between top and bottom J tracks. Use J tracks for all closure details, including duct and door openings, abutments, intersections, etc. No other special metal components are required.

Studs are automatically spaced 24 in. (610 mm) o.c. maximum with installation of shaftliner panels.

The data relating to fire and sound-tested assemblies is based on the characteristics, properties and performance of materials and systems obtained under controlled test conditions as set forth under the appropriate ASTM standard, such as E119 (fire), E90 (sound) or E72 (structural).

Outstanding Warranty

DensGlass® Shaftliner Shaftwall/Stairwell is covered by a 12-month limited warranty against delamination and deterioration for exposure to normal weather conditions. For a copy of the limited warranty, visit our website at www.buildgp.com/warranties.

Sustainability

Georgia-Pacific Gypsum and Sustainability

Georgia-Pacific Gypsum's definition of sustainability is meeting the needs of society today without jeopardizing our ability to do so in the future. We are committed to using resources efficiently to provide innovative products and solutions that meet the needs of customers and society while operating in a manner that is environmentally and socially responsible, and economically sound.

We continue to focus on:

- Improving energy efficiency at our manufacturing plants
- Seeking opportunities to reduce water use, and to reuse water more efficiently
- Finding new ways to reduce and improve air emissions
- Ensuring responsible resource management through material recovery and source reduction innovation

Green building standards and rating systems have been established across the country. They promote the use of products that contribute to the building's performance and minimize environmental and human health impacts over the building's life. Because we embrace product performance and operate in an environmentally, socially and economically sound manner, owners and architects can be proud of the structures they build using our products.

Many of our products contribute to LEED® and other green building programs. Please refer to the LEED Request link: LEED® Request Form - Georgia-Pacific Building Products (buildgp.com) to get recycled content, low-emitting material and regional material information for your project. For general sustainability information, visit www.buildgp.com/sustainability.

Installation Instructions

1. Secure J track as perimeter framing on floor and plumb to ceiling and sides. Attach with suitable fasteners, spaced not more than 24 in. (610 mm) o.c.
2. Plan the stud layout 24 in. (610 mm) o.c. and adjust the spacing at either end so the terminal stud will not fall closer than 8 in. (203 mm) from the end (is recommended). Pieces less than 8 in. (203 mm) may pose handling and installation problems such as cracking and breaking.
3. 1 in. (25.4 mm) DensGlass® Shaftliner panels should be cut no more than 3/4 in. (19 mm) for Intertek Designs or 1 in. (25.4 mm) for UL designs less than the total height of the framed section. Plumb the first panel flush against the long side of the J track and secure with 1-5/8 in. (41 mm) Type S screws 24 in. (610 mm) o.c. or bend out tabs in J track to secure panels in place. DensGlass® Shaftliner panels may be installed with either side facing out, however some authorities may require labeling to be visible.
4. Insert a C-T, C-H or I stud, cut 3/4 in. (19 mm) less than the overall height, into the top and bottom J track and fit tightly over the previously installed 1 in. (25.4 mm) panel.
5. Install the next 1 in. (25.4 mm) DensGlass® Shaftliner panel inside the J track and within the tabs of the C-T, C-H or I stud. Note that the edges of the panel are beveled to help guide the panel into the slotted and tabbed section of the stud.
6. Progressively install succeeding studs and panels as described above until the wall section is enclosed. The final panel section may be secured with 1-5/8 in. (41 mm) Type S screws or tabs from the J track at 24 in. (610 mm) o.c.
7. For doors, ducts or other large penetrations or openings, install J track as perimeter framing. Use true 20-gauge (33 mils) track with a 3 in. (76 mm) back leg for elevator doors and block cavity with 12 in. (305 mm) wide gypsum board filler strips for doors exceeding 7 ft. (2134 mm) in height. Attach metal intersections with a 3/8 in. (9.5 mm) pan head screw.
8. 1 in. (25.4 mm) DensGlass® Shaftliner panels may be abutted, spliced or stacked within the cavity. The shorter panel should be a minimum 2 ft. (610 mm) tall to engage two stud tabs on each panel edge. Joints of adjacent panels should be alternately stacked or staggered to prevent a continuous horizontal joint. Staggered Shaftliner joints are not required for UL V473 1 hour Shaftwall.
9. Fire tests were conducted without back blocking of shaftliner joints. Install factory cut edges back to back for all Intertek Designs and UL 1 hour V473.
- *10. For WHI GP/WA 120-01 finished 2 hour one side, install the base layer of 1/2 in. (12.7 mm) ToughRock® Fireguard C® Gypsum Board or 1/2 in. (12.7 mm) DensArmor Plus® Interior Panel horizontally with 1 in. (25.4 mm) Type S or S-12 screws spaced 24 in. (610 mm) o.c. starting 3 in. (76 mm) from top and bottom. (5/8 in. (15.9 mm) DensArmor Plus® Fireguard® Gypsum Panels may be used in lieu of 1/2 in. (12.7 mm) ToughRock® Fireguard C® Gypsum Board, (if desired.) The horizontal joints should be offset from any splice joints in the shaftliner panels by at least 12 in. (305 mm). Install the face layer vertically with 1-5/8 in. (41 mm) Type S or S-12 screws spaced 12 in. (305 mm) o.c. starting 6 in. (152 mm) from top and bottom. (All edge and end joints should be offset from the base layer by 24 in. (610 mm) o.c.)
- *11. For WHI GP/WA 120-02, finished 2 hour both sides, each side must be installed vertically with 1 in. (25.4 mm) Type S or S-12 screws spaced 12 in. (305 mm) starting 6 in. (152 mm) from top and bottom and with vertical joints offset 24 in. (610 mm). Edges and ends on opposite sides offset 24 in. (610 mm) o.c.
- *12. For WHI GP/WA 60-01, finished 1 hour one side, apply the 5/8 in. (15.9 mm) ToughRock® Fireguard X® Gypsum Board or 5/8 in. (15.9 mm) DensArmor Plus® Interior Panel horizontally or vertically with 1 in. (25.4 mm) Type S or S-12 screws spaced 12 in. (305 mm) o.c.
- *13. For UL V473, 2 hour finished one side, install the base layer of 5/8 in. (15.9 mm) ToughRock® Fireguard X® Gypsum Board or 5/8 in. (15.9 mm) DensArmor Plus® Interior Panel horizontally or vertically with 1 in. (25.4 mm) Type S screws spaced 24 in. (610 mm) o.c. Face layer applied vertically, attached with 1-5/8 in. (41 mm) Type S screws spaced 12 in. (305 mm) o.c. (All end and edge joints should be offset from the base layer by 24 in. (610 mm) o.c.)
- *14. For UL V473, 1 hour, apply 5/8 in. (15.9 mm) ToughRock® Fireguard X® Gypsum Board or 5/8 in. (15.9 mm) DensArmor Plus® Interior Panel horizontally or vertically. Vertical joints centered over studs. Attach with 1 in. (25.4 mm) Type S or S-12 screws spaced 8 in. (203 mm) o.c.
15. When used as HVAC ducts, consult with HVAC engineer regarding level of caulking and sealant required. All joints on face layers are to be taped and finished and fasteners finished with joint compound meeting ASTM C475. All penetration openings are to be filled with firestopping sealants.
16. For more information on firestopping through penetrations in shaftwall systems or head of wall shaftwall details, consult the UL directory or other fire testing agencies' listings.

**Consult the UL or WHI listing or test report for complete assembly information.*

CAUTION: For product fire, safety and use information, go to buildgp.com/safetyinfo.

For latest information and updates: **5**
Technical Service Hotline 1.800.225.6119 or buildgp.com

See individual fire test listings for approved studs. Drawings are not to scale.

C-T Stud Detail

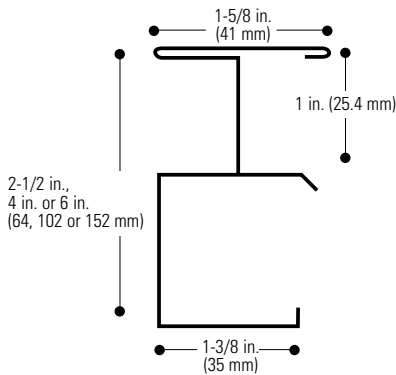

C-H Stud Detail

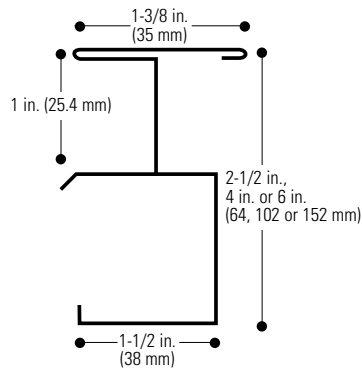

I Stud Detail

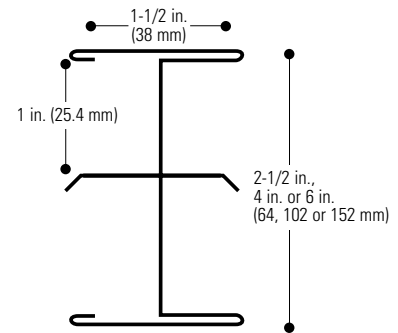

J Track

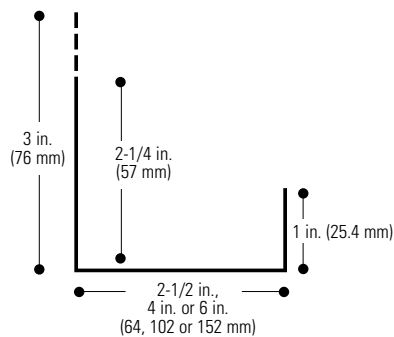

J-L Corner

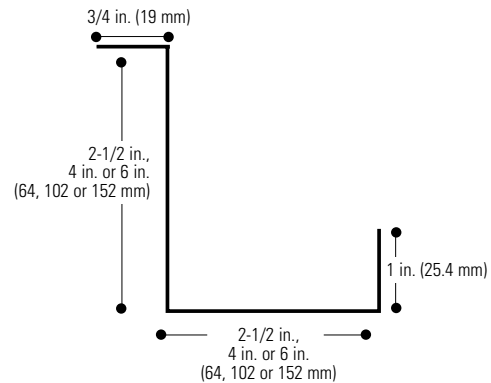

Recommendations

- Use a fastening plate to secure the J track whenever fasteners are closer than 4 in. (102 mm) to the end of the assembly. Setting the plate at the time of concrete construction will avoid spalling by mechanical fasteners.
- In structural steel-frame construction, install J track sections before applying spray-on fireproofing.
- Items to be anchored to the wall (cabinets, sinks, handrails, etc.) should be fastened to the C-T, C-H or I studs or to plates secured behind or between layers of gypsum board. (See handrail illustration on page 18.)
- Joint compounds should be applied at ambient temperatures above 50°F (10°C) with adequate ventilation.
- Use Type S screws for true 25-gauge (18 mils) steel framing. Use Type S-12 screws for true 20-gauge (33 mils) (or heavier) steel framing.
- It is important that the job structural engineer approves the type, size and maximum spacing of track fasteners to meet the design load requirements.

Design Summary Vertical Applications

DensGlass® Shaftliner is UL and ULC certified as **Type DGUSL** and included in numerous assembly designs listed by UL and ULC for hourly fire resistance ratings. In addition, DensGlass® Shaftliner is classified as **Type X** in accordance with ASTM C1658 and may replace 1 in (25.4 mm) gypsum shaftliner panels specified as **Type X** in generic fire-rated wall assemblies.

Generic systems in the GA-600 Fire Resistance Design Manual are applicable to the products of any manufacturer, including Georgia-Pacific Gypsum, provided they meet certain standards set forth in such manual, such as **Type X** gypsum board per applicable ASTM standard with specified thickness and size described in the design. **Type X** as used in this technical guide designates gypsum board manufactured and tested in accordance with specific ASTM standards for increased fire resistance beyond regular gypsum boards. Please consult the ASTM standard for the specific product (for example, ASTM C1658 for glass mat gypsum panels) for further information and significance of use.

The following design assemblies are for illustrative purposes only. Consult the appropriate fire resistance directory for complete assembly information. For additional fire safety information concerning DensGlass® Shaftliner, visit www.buildgp.com/safetyinfo.

Proprietary GA-600 Designs: Assemblies listed as proprietary in the GA-600 Fire Resistance Design Manual only list one product per manufacturer and may not include all products referenced in the illustrations below. Please consult the specified UL, ULC, cUL or other fire listing or test for a complete list of approved products.

1-Hour Fire Rating

Design Reference: WHI Design GP/WA 60-01

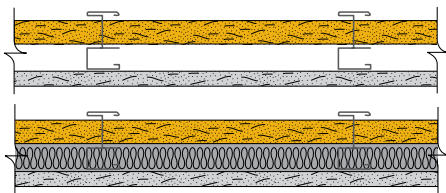

40-44 STC Sound Transmission

Test Reference: RAL TL 09-357

Approx. Weight: 7 psf (34 kg/m²)

One layer 1 in. (25.4 mm) ToughRock® Shaftliner or 1 in. (25.4 mm) DensGlass® Shaftliner inserted between 2-1/2 in. (64 mm) floor and ceiling J runners with H section of 2-1/2 in. (64 mm) C-H, C-T, or I studs between panels. Panels attached to the top J runner with three 1-5/8 in. (41 mm) Type S screws, one at each edge and one at mid width of the board. Attach panels to vertical J runners with 1-5/8 in. (41 mm) Type S screws spaced 24 in (610 mm) o.c.

OPPOSITE SIDE: 5/8 in. (15.9 mm) ToughRock® Fireguard X® Gypsum Board or 5/8 in. (15.9 mm) DensArmor Plus® Fireguard® Gypsum Panels applied vertically or horizontally to studs with 1 in. (25.4 mm) Type S drywall screws 12 in. (305 mm) o.c.

C-T, C-H or I Stud	2-1/2 in. (64 mm)	4 in. (102 mm)	6 in. (152 mm)
Wall Thickness	3-1/8 in. (80 mm)	4-5/8 in. (118 mm)	6-5/8 in. (168 mm)

1-Hour Fire Rating

Design Reference: UL V473, cUL V473, GA WP 6851

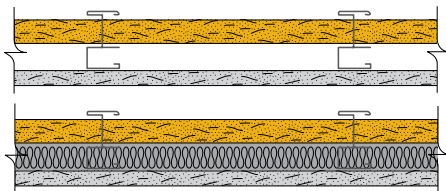

40-44 STC Sound Transmission

Test Reference: RAL TL 09-357

Approx. Weight: 7 psf (34 kg/m²)

Sound tested with 1-1/2 in. (38 mm) glass fiber insulation friction fit in stud cavity and with the 5/8 in. (15.9 mm) proprietary type X gypsum wallboard applied with screws spaced 12 in. (305 mm) o.c. (NLB)

One layer 1 in. (25.4 mm) ToughRock® Shaftliner or 1 in. (25.4 mm) DensGlass® Shaftliner inserted between 2-1/2 in. (64 mm) floor and ceiling J runners with H section of 2-1/2 in. (64 mm) C-H, C-T, or I studs between panels.

OPPOSITE SIDE: One layer 5/8 in. (15.9 mm) ToughRock® Fireguard X® Gypsum Board or 5/8 in. (15.9 mm) DensArmor Plus® Fireguard® Interior Panels applied vertically or horizontally to studs with 1 in. (25.4 mm) Type S drywall screws 8 in. (203 mm) o.c.

C-T, C-H or I Stud	2-1/2 in. (64 mm)	4 in. (102 mm)	6 in. (152 mm)
Wall Thickness	3-1/8 in. (80 mm)	4-5/8 in. (118 mm)	6-5/8 in. (168 mm)

Design Summary Vertical Applications *continued*

2-Hour Fire Rating

Design Reference: UL V473, cUL V473, GA WP 7054

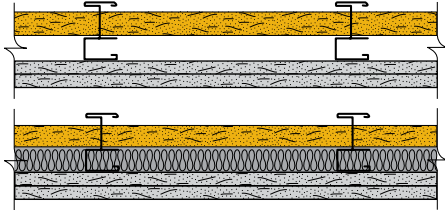

50-54 STC Sound Transmission

Test Reference: RAL TL 09-358
Approx. Weight: 9 psf (44 kg/m²)

Sound tested with 1-1/2 in. (38 mm) glass fiber insulation friction fit in stud space. (NLB)

One layer 1 in. (25.4 mm) ToughRock® Shaftliner or 1 in. (25.4 mm) DensGlass® Shaftliner inserted between 2-1/2 in. (64 mm) floor and ceiling J runners with H section of 2-1/2 in. (64 mm) C-H, C-T, or I studs between panels.

OPPOSITE SIDE: **Base** layer 5/8 in. (15.9 mm) ToughRock® Fireguard X® Gypsum Board or 5/8 in. (15.9 mm) DensArmor Plus® Fireguard® Interior Panels applied vertically or horizontally to studs with 1 in. (25.4 mm) Type S drywall screws 24 in. (610 mm) o.c.

Face layer 5/8 in. (15.9 mm) ToughRock® Fireguard X® Gypsum Board or 5/8 in. (15.9 mm) DensArmor Plus® Fireguard® Interior Panels applied vertically to studs with 1-5/8 in. (41 mm) Type S drywall screws 12 in. (305 mm) o.c. along top and bottom tracks and 12 in. (305 mm) o.c. at vertical joints and intermediate studs. Face layer joints offset 24 in. (610 mm) from base layer joints.

C-T, C-H or I Stud	2-1/2 in. (64 mm)	4 in. (102 mm)	6 in. (152 mm)
Wall Thickness	3-3/4 in. (95 mm)	5-1/4 in. (133 mm)	7-1/4 in. (184 mm)

2-Hour Fire Rating

Design Reference: UL V473, ULC W481, cUL V473, GA WP 7059

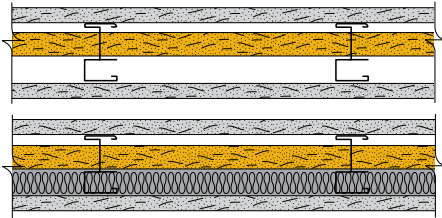

50-54 STC Sound Transmission

Test Reference: RAL TL 09-358
Approx. Weight: 9 psf (44 kg/m²)

Sound tested with 1-1/2 in. (38 mm) glass fiber insulation friction fit in stud space. (NLB)

One layer 1 in. (25.4 mm) ToughRock® Shaftliner or 1 in. (25.4 mm) DensGlass® Shaftliner inserted between 2-1/2 in. (64 mm) floor and ceiling J runners with H section of 2-1/2 in. (64 mm) C-H, C-T, or I studs between panels.

One layer 5/8 in. (15.9 mm) ToughRock® Fireguard X® Gypsum Board or 5/8 in. (15.9 mm) DensArmor Plus® Fireguard® Interior Panels applied vertically to each side with 1 in. (25.4 mm) Type S drywall screws 12 in. (305 mm) o.c.

C-T, C-H or I Stud	2-1/2 in. (64 mm)	4 in. (102 mm)	6 in. (152 mm)
Wall Thickness	3-3/4 in. (95 mm)	5-1/4 in. (133 mm)	7-1/4 in. (184 mm)

2-Hour Fire Rating

Design Reference: UL U428, GA WP 7051

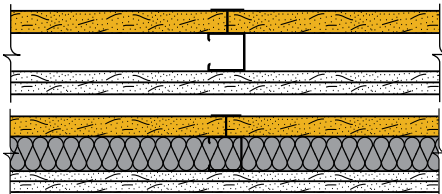

50-54 STC Sound Transmission

Test Reference: RAL TL93-181
Approx. Weight: 9 psf (44 kg/m²)

Sound tested with 1-1/2 in. (38 mm) glass fiber insulation in stud space. (NLB)

One layer 1 in. x 24 in. (25.4 mm x 610 mm) DensGlass® Shaftliner or ToughRock® Shaftliner Gypsum Panels inserted between 2-1/2 in. (64 mm) floor and ceiling J runners with T section of 2-1/2 in. (64 mm) steel C-H or C-T studs between panels.

OPPOSITE SIDE: **Base** layer 1/2 in. (12.7 mm) DensArmor Plus® Fireguard C® or 1/2 in. (12.7 mm) ToughRock® Fireguard C® Gypsum Wallboard applied at right angles to studs with 1 in. (25.4 mm) Type S drywall screws 24 in. (610 mm) o.c. **Face** layer 1/2 in. (12.7 mm) DensArmor Plus® Fireguard C or 1/2 in. (12.7 mm) ToughRock® Fireguard C® Gypsum Wallboard applied parallel to studs with 1-5/8 in. (41 mm) Type S drywall screws 12 in. o.c. (305 mm)

Design Summary Vertical Applications *continued*

2-Hour Fire Rating

Design Reference: UL U429, GA WP 7052

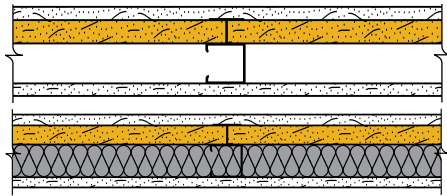

50-54 STC Sound Transmission

Test Reference: RAL TL93-181

Approx. Weight: 9 psf (44 kg/m²)

Sound tested with 1-1/2 in. (38 mm) glass fiber insulation in stud space. (NLB)

One layer 1 in. x 24 in. (25.4 mm x 610 mm) DensGlass® Shaftliner or ToughRock® Shaftliner Gypsum Panels inserted between 2-1/2 in. (64 mm) floor and ceiling J runners with T section of 2-1/2 in. (64 mm) steel C-H or C-T studs between panels. **Face** layer 1/2 in. (12.7 mm) DensArmor Plus® Fireguard C® or 1/2 in. (12.7 mm) ToughRock® Fireguard C® Gypsum Wallboard applied parallel to studs with vertical joints midway between studs and laminated to the 1/2 in. (12.7 mm) DensArmor Plus® Fireguard C® or 1/2 in. (12.7 mm) ToughRock® Fireguard C® Gypsum Wallboard with 4 in. (101.6 mm) wide strips of taping compound at wallboard perimeter and vertical centerline. 1-1/2 in. (38 mm) Type G drywall screws 24 in. o.c. located 1-1/2 in. (38 mm) back from wallboard edges and at vertical centerline.

OPPOSITE SIDE: One layer 1/2 in. (12.7 mm) DensArmor Plus® Fireguard C® or 1/2 in. (12.7 mm) ToughRock® Fireguard C® Gypsum Wallboard applied at right angles to studs with 1 in. (25.4 mm) Type S drywall screws 24 in. (610 mm) o.c.

2-Hour Fire Rating

Design Reference: UL V433-System B, GA WP 7255

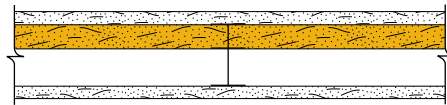

Approx. Weight: 9 psf (44 kg/m²)

One layer 1 in. x 24 in. (25.4 mm x 610 mm) DensGlass® Shaftliner or ToughRock® Shaftliner Gypsum Panels inserted between 2-1/2 in. (64 mm) floor and ceiling J runners with tab flange section of 2-1/2 in. (64 mm) steel I studs between panels.

One layer 1/2 in. (12.7 mm) ToughRock® Fireguard C® Gypsum Wallboard applied parallel to each side with 1 in. (25.4 mm) Type S drywall screws 12 in. (305 mm) o.c. Vertical joints are offset one stud space each side (NLB)

2-Hour Fire Rating

Design Reference: UL W437

System A



System B

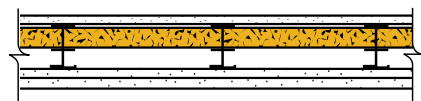

System A

One layer 1 in. x 24 in. (25.4 mm x 610 mm) DensGlass® Shaftliner or ToughRock® Shaftliner Gypsum Panels inserted between 2-1/2 in. (64 mm) floor and ceiling J runners with tab flange section of 2-1/2 in. (64 mm) steel I studs between panels.

OPPOSITE SIDE: **Base** layer 1/2 in. (12.7 mm) ToughRock® Fireguard C® Wallboard applied at right angles to studs with 1 in. (25.4 mm) Type S drywall screws 24 in. (610 mm) o.c.

Face layer 1/2 in. (12.7 mm) ToughRock® Fireguard C® Gypsum Wallboard applied parallel to studs with 1-5/8 in. (41 mm) Type S drywall screws 12 in. (305 mm) o.c.

System B

One layer 1 in. x 24 in. (25.4 mm x 610 mm) DensGlass® Shaftliner or ToughRock® Shaftliner Gypsum Panels inserted between 2-1/2 in. (64 mm) floor and ceiling J runners with tab flange section of 2-1/2 in. (64 mm) steel I studs between panels. One layer 1/2 in. (12.7 mm) ToughRock® Fireguard C® Gypsum Wallboard applied parallel to each side with 1 in. (25.4 mm) Type S drywall screws 12 in. (305 mm) o.c. Vertical joints are offset one stud space each side (NLB)

Design Summary Vertical Applications *continued*

2-Hour Fire Rating

Design Reference: UL U529

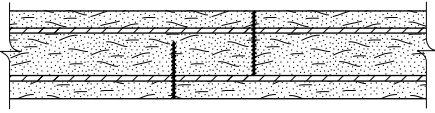

Support angles- 1 in. (25.4 mm) by 2 in. (50.8 mm) steel "L" runners to support the wall along the perimeter. Angles mechanically attached to structure spaced 24 in. (610 mm) o.c. 1/2 in. (12.7 mm) DensArmor Plus® Fireguard C® or 1/2 in. (12.7 mm) ToughRock® Fireguard C® Gypsum Wallboard applied vertically and secured to support angles with 1 in. (25.4 mm) Type S drywall screws spaced 12 in. (305 mm) o.c. The wallboard is laminated* and secured to each side of the 1 in. x 24 in. (25.4 mm x 610 mm) DensGlass® Shaftliner or ToughRock® Shaftliner Panel also applied vertically (with wallboard joints centered over liner panels) with 1-1/2 in. (38 mm) Type G steel screws spaced 24 in. (610 mm) o.c. in both directions. Joints of wallboard layers offset 24 in. (610 mm).

*Joint compound applied uniformly to both surfaces of 1 in. x 24 in. (25.4 mm x 610 mm) DensGlass® Shaftliner or ToughRock® Shaftliner Gypsum Panels with a notched spreader 1/4 in. x 1/4 in. (6.35 mm x 6.35 mm) spaced 1 in. (25.4 mm) o.c.

2-Hour Fire Rating

Design Reference:
WHI Design GP/WA 120-01, GA WP 7054.4

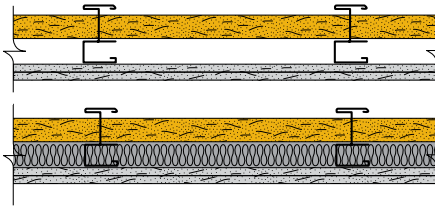

50-54 STC Sound Transmission

Test Reference: RAL TL 09-360
Approx. Weight: 9 psf (44 kg/m²)

Sound tested with 1-1/2 in. (38 mm) glass fiber insulation friction fit in stud space. (NLB)

One layer 1 in. (25.4 mm) ToughRock® Shaftliner or 1 in. (25.4 mm) DensGlass® Shaftliner inserted between 2-1/2 in. (64 mm) floor and ceiling J runners with H section of 2-1/2 in. (64 mm) C-H, C-T, or I studs between panels.

OPPOSITE SIDE: **Base** layer 1/2 in. (12.7 mm) ToughRock® Fireguard C® Gypsum Board or 1/2 in. (12.7 mm) DensArmor Plus® Fireguard C® Interior Panels applied horizontally to studs with 1 in. (25.4 mm) Type S drywall screws 24 in. (610 mm) o.c. and 3 in. (76 mm) from floor and ceiling runners. **Face** layer 1/2 in. (12.7 mm) ToughRock® Fireguard C® Gypsum Board or 1/2 in. (12.7 mm) DensArmor Plus® Fireguard C® Interior Panels applied vertically to studs with 1-5/8 in. (41 mm) Type S drywall screws 12 in. (305 mm) o.c. and 6 in. (152 mm) from floor and ceiling runners. Joints offset 24 in. (610 mm) from base layer joints.

C-T, C-H or I Stud	2-1/2 in. (64 mm)	4 in. (102 mm)	6 in. (152 mm)
Wall Thickness	3-1/2 in. (89 mm)	5 in. (127 mm)	7 in. (178 mm)

2-Hour Fire Rating

Design Reference:
WHI Design GP/WA 120-02, GA WP 7073

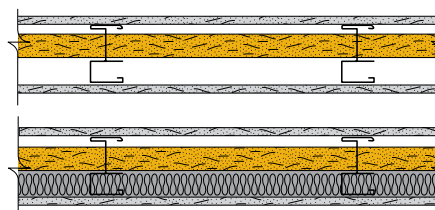

45-49 STC Sound Transmission

Test Reference: RAL TL 09-359
Approx. Weight: 9 psf (44 kg/m²)

Sound tested with 1-1/2 in. (38 mm) glass fiber insulation friction fit in stud space. (NLB)

One layer 1 in. (25.4 mm) ToughRock® Shaftliner or 1 in. (25.4 mm) DensGlass® Shaftliner inserted between 2-1/2 in. (64 mm) floor and ceiling J runners with H section of 2-1/2 in. (64 mm) C-H, C-T, or I studs between panels.

One layer 1/2 in. (12.7 mm) ToughRock® Fireguard C® Gypsum Board or DensArmor Plus® Fireguard C® Interior Panels applied vertically to each side with 1 in. (25.4 mm) Type S drywall screws 12 in. (305 mm) o.c. Joints staggered 24 in. (610 mm) on opposite sides.

C-T, C-H or I Stud	2-1/2 in. (64 mm)	4 in. (102 mm)	6 in. (152 mm)
Wall Thickness	3-1/2 in. (89 mm)	5 in. (127 mm)	7 in. (178 mm)

Design Summary Vertical Applications *continued*

3-Hour Fire Rating

Design Reference: WHI GP/WA 180-01,
GA WP 7422

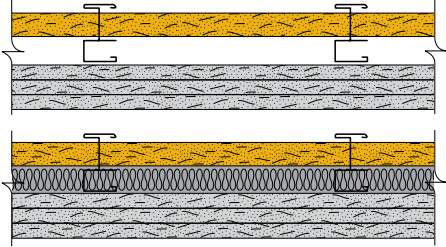

50-54 STC Sound Transmission

Test Reference: RAL TL 09-360
Approx. Weight: 12 psf (59 kg/m²)

Sound tested with 1-1/2 in. (38 mm) glass fiber insulation friction fit in stud space. (NLB)
One layer 1 in. (25.4 mm) ToughRock® Shaftliner or 1 in. (25.4 mm) DensGlass® Shaftliner inserted between 2-1/2 in. (64 mm) floor and ceiling J runners with H section of 2-1/2 in. (64 mm) C-H, C-T, or I studs between panels.

OPPOSITE SIDE: **Base** layer 5/8 in. (15.9 mm) ToughRock® Fireguard C® Gypsum Board or 5/8 in. (15.9 mm) DensArmor Plus® Fireguard C® Interior Panels applied horizontally to studs with 1 in. (25.4 mm) Type S drywall screws 24 in. (610 mm) o.c. **Second** layer 5/8 in. (15.9 mm) ToughRock® Fireguard C® Gypsum Board or 5/8 in. (15.9 mm) DensArmor Plus® Fireguard C® Interior Panels applied horizontally to studs with 1-5/8 in. (41 mm) Type S drywall screws 16 in. (406 mm) o.c. at studs and 1-1/2 in. (38 mm) Type G drywall screws 16 in. (406 mm) o.c. placed 2 in. (51 mm) from any vertical joints. **Face** layer 5/8 in. (15.9 mm) ToughRock® Fireguard C® Gypsum Board or 5/8 in. (15.9 mm) DensArmor Plus® Fireguard C® Interior Panels applied vertically to studs with 2-1/4 in. (57 mm) Type S drywall screws 12 in. (305 mm) o.c. at studs and 1-1/2 in. (38 mm) Type G drywall screws 12 in. (305 mm) o.c. placed 2 in. (51 mm) from either side of horizontal joints.

C-T, C-H or I Stud	2-1/2 in. (64 mm)	4 in. (102 mm)	6 in. (152 mm)
Wall Thickness	4-3/8 in. (111 mm)	5-7/8 in. (149 mm)	7-7/8 in. (200 mm)

3-Hour Fire Rating

Design Reference: GP/GBA 180-02

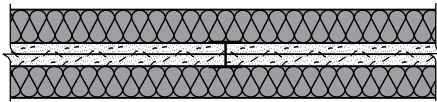

Approx. wt. 10 psf (49 kg/m²)

Two layers 1 in. (25.4 mm) x 24 in. (610 mm) ToughRock® Shaftliner or 1 in. (25.4 mm) DensGlass® Shaftliner inserted between 2 in. (51 mm) floor and ceiling runners with 2 in. (51 mm) steel H or I studs between adjacent pairs of gypsum panels. 2 in. (51 mm) mineral fiber insulation, 3.0 pcf, applied over each side and stapled to gypsum panels. (NLB)

Design Summary Horizontal – Shaftwall Assemblies

2-Hour Fire Rating

Test Reference: WHI-495-PSH-0128

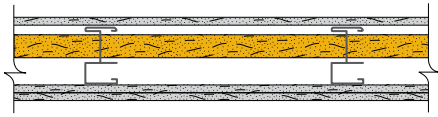

One layer 1 in. (25.4 mm) DensGlass® Shaftliner inserted between 2-1/2 in. (64 mm) floor and ceiling J runners with H section of 2-1/2 in. (64 mm) C-T studs between panels.

Three layers of 1/2 in. (12.7 mm) ToughRock® Fireguard C® Gypsum Board or DensArmor Plus® Fireguard C® Interior Panels applied.

Base layer applied horizontally to studs with 1 in. (25.4 mm) Type S screws 12 in. (305 mm) o.c. in the field and 8 in. (203 mm) o.c. at butt ends. **Face** layer applied horizontally to studs with 1-5/8 in. (41 mm) Type S screws 12 in. (305 mm) o.c.

OPPOSITE SIDE: One layer applied vertically to studs with 1-1/2 in. (38 mm) Type G screws 12 in. (305 mm) o.c. Butt joints midway between studs with face layer attached to base layers using 1-1/2 in. (38 mm) Type G screws 8 in. (203 mm) o.c.

2-Hour Fire Rating

Test Reference: WHI-495-PSH-0153,
WHI-495-PSH-0197

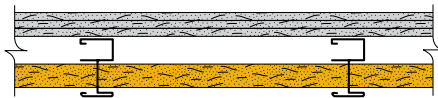

One layer 1 in. (25.4 mm) DensGlass® Shaftliner inserted between 2-1/2 in. (64 mm) floor and ceiling J runners with H section of 2-1/2 in. (64 mm) C-T studs between panels.

Three layers of 1/2 in. (12.7 mm) ToughRock® Fireguard C® Gypsum Board or DensArmor Plus® Fireguard C® Interior Panels applied to opposite side of Shaftliner.

Base layer applied vertically to studs with 1 in. (25.4 mm) Type S screws 24 in. (610 mm) o.c. **Second** layer applied vertically to studs with 1-5/8 in. (41 mm) Type S screws 24 in. (610 mm) o.c. **Face** layer applied horizontally to studs with 2 in. (51 mm) Type S screws 24 in. (610 mm) o.c. Butt joints midway between studs with face layer attached to base layers using 1-1/2 in. (38 mm) Type G screws 8 in. (203 mm) o.c.

2-Hour Fire Rating

Design Reference: WHI GP/CC 120-01
Test Reference: WHI-495-PSH-0183,
WHI-495-PSH-0196

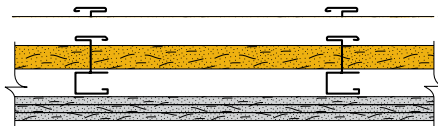

One layer 1 in. (25.4 mm) DensGlass® Shaftliner inserted between 2-1/2 in. (64 mm) floor and ceiling J runners with H section of 2-1/2 in. (64 mm) C-T studs between panels.

Three layers of 1/2 in. (12.7 mm) ToughRock® Fireguard C® Gypsum Board or DensArmor Plus® Fireguard C® Interior Panels applied to opposite side of Shaftliner.

Base layer applied vertically to studs with 1 in. (25.4 mm) Type S screws 24 in. (610 mm) o.c. **Second** layer applied vertically to studs with 1-5/8 in. (41 mm) Type S screws 12 in. (610 mm) o.c. **Face** layer applied horizontally to studs with 2 in. (51 mm) Type S screws 12 in. (610 mm) o.c. Butt joints midway between studs with face layer attached to base layers using 1-1/2 in. (38 mm) Type G screws 8 in. (203 mm) o.c.

Maximum Horizontal Spans

When used as a horizontal membrane, the framing member length should not exceed those in the following table.

C-T Stud	Nominal Gauge	Vertical Shaftwall 1-Hour		Vertical Shaftwall 2-Hour		Horizontal Shaftwalls 2-Hour	
		L/240	L/360	L/240	L/360	L/240	L/360
2-1/2 in. (64 mm)	25 (18 mils)	9 ft. 4 in. (2845 mm)	8 ft. 2 in. (2489 mm)	8 ft. 8 in. (2642 mm)	7 ft. 7 in. (2311 mm)	8 ft. 1 in. (2464 mm)	7 ft. 1 in. (2159 mm)
2-1/2 in. (64 mm)	20 (33 mils)	11 ft. 1 in. (3378 mm)	9 ft. 8 in. (2946 mm)	10 ft. 4 in. (3150 mm)	9 ft. 0 in. (2743 mm)	9 ft. 8 in. (2946 mm)	8 ft. 5 in. (2565 mm)
4 in. (102 mm)	25 (18 mils)	13 ft. 2 in. (4013 mm)	11 ft. 6 in. (3505 mm)	12 ft. 4 in. (3759 mm)	10 ft. 9 in. (3277 mm)	11 ft. 6 in. (3505 mm)	10 ft. 0 in. (3048 mm)
4 in. (102 mm)	20 (33 mils)	15 ft. 6 in. (4724 mm)	13 ft. 7 in. (4140 mm)	14 ft. 7 in. (4445 mm)	12 ft. 9 in. (3886 mm)	13 ft. 7 in. (4140 mm)	11 ft. 10 in. (3607 mm)
6 in. (152 mm)	25 (18 mils)	17 ft. 11 in. (5461 mm)	15 ft. 8 in. (4775 mm)	16 ft. 9 in. (5105 mm)	14 ft. 7 in. (4445 mm)	15 ft. 7 in. (4750 mm)	13 ft. 7 in. (4140 mm)
6 in. (152 mm)	20 (33 mils)	21 ft. 1 in. (6426 mm)	18 ft. 6 in. (5639 mm)	19 ft. 9 in. (6020 mm)	17 ft. 3 in. (5258 mm)	18 ft. 6 in. (5639 mm)	16 ft. 2 in. (4928 mm)

Span calculations based on stud properties. Use 20-gauge (33 mils) J track.

2-Hour Vertical and Horizontal Shaftwalls Around Horizontal Membranes and Ducts

DensGlass® Shaftliner Components

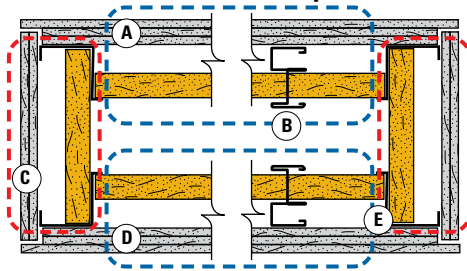

- A. WHI 495-PSH-0153
- B. C-T, C-H or I stud
- C. WHI GP/WA 120-01
- D. WHI GP/CC 180-01
- E. J-L corner or back to back J track

1/2 in. (12.7 mm) DensArmor Plus® Fireguard C® Interior Panels, 1/2 in. (12.7 mm) ToughRock® Fireguard C®, 5/8 in. (15.9 mm) DensArmor Plus® Fireguard® and 5/8 in. (15.9 mm) ToughRock® Fireguard X® Gypsum Boards are manufactured to meet or exceed applicable sections of ASTM C1658 and ASTM C1396.

These products may be used for other related corridor and party walls, often eliminating the need to stock more than one type at the job site. Depending on the fire rating, one or more layers are installed on the studs with drywall screws. Screws are not required to secure either layer to the top or bottom J tracks. Refer to the sections covering specific fire ratings for the number of layers required and the detailed attachment procedures.

1 in. (25.4 mm) DensGlass® Shaftliner Panels are manufactured to meet or exceed ASTM C1658 and ASTM C1396. Panels are made in a normal width of 23-7/8 in. (606 mm) with double beveled edges. DensGlass® Shaftliner Panels install easily within the flanges of the C-T studs. Screws may be installed at the top J track to hold the panel in place.

Drive 1-5/8 in. (41 mm) Type S screws 24 in. (610 mm) o.c. maximum through the shaftliner to the J track at corner and abutments or use the turnout tabs to secure the panel in place.

DensGlass® Shaftliner Assemblies Meet IBC Requirement for Interior Exit Stairways and Elevator Hoistway Enclosures

Two DensGlass® Shaftliner assemblies have been shown to meet the prescriptive requirements in Section 403.2.3 of the International Building Code (IBC) structural integrity of interior exit stairway enclosures and elevator hoistway enclosures. The code calls for the “hardening” of these wall assembly enclosures by meeting both soft body and hard body impact criteria as measured by ASTM C1629.

This prescriptive requirement (meeting soft body and hard body impact requirements) in section 403.2.3 applies to high-rise buildings that are considered high occupancy or essential as defined by code (Category III and IV), and all buildings that are more than 420 ft. (128 m) in height.

Design Reference UL V473

Two 2-hour fire-rated assemblies, consisting of 5/8 in. (15.9 mm) Gypsum Panels and 1 in. (25.4 mm) Gypsum Shaftliner Panels as shown.

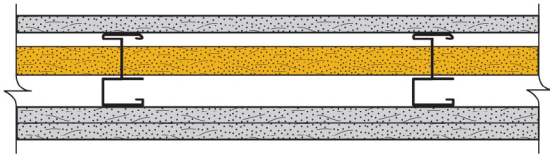

Summary of test results for single layer on shaftwall side per ASTM C1629 testing

Shaftwell or shaft side Single Layer [†]	Soft Body Impact Level (0-3)	Hard Body Impact Level (0-3)
DensArmor Plus®	3	3

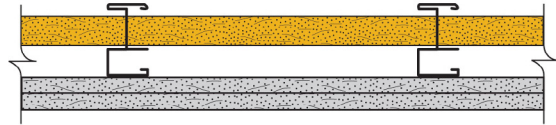

Summary of test results for 2 layer on tenant side per ASTM C1629 testing

Tenant Side Double Layer [†]	Soft Body Impact Level (0-3)	Hard Body Impact Level (0-3)
DensArmor Plus® Impact-Resistant/ DensArmor Plus® Impact-Resistant	3*	3
DensArmor Plus® Impact-Resistant/ ToughRock® Fireguard X® Abuse-Resistant	3*	3
DensArmor Plus® Impact-Resistant/ DensArmor Plus® Abuse-Resistant	3*	3
DensArmor Plus® Impact-Resistant/ ToughRock® Fireguard X®	3	3
DensArmor Plus® Impact-Resistant/ DensArmor Plus® Fireguard®	3	3

[†] Each layer comprised of 5/8 in. panel.

* Determined by Timber Products Inspection, Inc. (testing company) based on testing of the weakest components.

Sound Chart

Fire Rated Assembly No.	Stud Size	Insulation Thickness	Resilient Channel	STC	Sound Report No.
UL V473 - 1 hr./WHI GP/WA 60/01	2-1/2 in.	1-1/2 in.	No	43	RAL TL09-357
UL V473 - 1 hr./WHI GP/WA 60/01	2-1/2 in.	1-1/2 in.	Yes	48	RAL TL09-363
UL V473 - 1 hr./WHI GP/WA 60/01	4 in.	2-1/2 in.	No	47	RAL TL10-22
UL V473 - 1 hr./WHI GP/WA 60/01	4 in.	2-1/2 in.	Yes	52	RAL TL10-27
UL V473 - 2 hr.	2-1/2 in.	1-1/2 in.	No	51	RAL TL09-358
UL V473 - 2 hr.	2-1/2 in.	1-1/2 in.	Yes	54	RAL TL09-364
UL V473 - 2 hr.	4 in.	2-1/2 in.	No	52	RAL TL10-21
UL V473 - 2 hr.	4 in.	2-1/2 in.	Yes	56	RAL TL10-28
WHI GP/WA 120-01	2-1/2 in.	1-1/2 in.	No	50	RAL TL09-360
WHI GP/WA 120-01	2-1/2 in.	1-1/2 in.	Yes	52	RAL TL09-362
WHI GP/WA 120-01	4 in.	2-1/2 in.	No	52	RAL TL10-24
WHI GP/WA 120-01	4 in.	2-1/2 in.	Yes	56	RAL TL10-26
WHI GP/WA 120-02	2-1/2 in.	1-1/2 in.	No	46	RAL TL09-359
WHI GP/WA 120-02	2-1/2 in.	1-1/2 in.	Yes	51	RAL TL09-361
WHI GP/WA 120-02	4 in.	2-1/2 in.	No	52	RAL TL10-23
WHI GP/WA 120-02	4 in.	2-1/2 in.	Yes	55	RAL TL10-25

Limiting Heights for 1-, 2- and 3-Hour Systems

C-T Stud Depth	Stud & Track Gauge	Design Deflection Limit	Uniform Load (PSF)							
			For 1-hr.				For 2- to 3-hr.			
			5	7.5	10	15	5	7.5	10	15
2.5 in. (64 mm)	25 (18 mils)	L/120	14 ft. 2 in. (4318 mm)	12 ft. 5 in. (3785 mm)	11 ft. 3 in. (3429 mm)	9 ft. 4 in. (2845 mm)	15 ft. 6 in. (4724 mm)	13 ft. 3 in. (4037 mm)	11 ft. 6 in. (3605 mm)	9 ft. 5 in. (2870 mm)
		L/180	12 ft. 5 in. (3785 mm)	10 ft. 10 in. (3302 mm)	9 ft. 10 in. (2997 mm)	8 ft. 7 in. (2616 mm)	13 ft. 7 in. (4140 mm)	11 ft. 10 in. (3607 mm)	10 ft. 9 in. (3277 mm)	9 ft. 5 in. (2870 mm)
		L/240	11 ft. 3 in. (3429 mm)	9 ft. 10 in. (2997 mm)	8 ft. 11 in. (2718 mm)	7 ft. 10 in. (2388 mm)	12 ft. 4 in. (3759 mm)	10 ft. 9 in. (3277 mm)	9 ft. 9 in. (2972 mm)	8 ft. 6 in. (2591 mm)
		L/360	9 ft. 10 in. (2997 mm)	8 ft. 7 in. (2616 mm)	7 ft. 10 in. (2388 mm)	6 ft. 10 in. (2083 mm)	10 ft. 9 in. (3277 mm)	9 ft. 5 in. (2870 mm)	8 ft. 6 in. (2591 mm)	7 ft. 6 in. (2286 mm)
2.5 in. (64 mm)	20 (33 mils)	L/120	15 ft. 10 in. (4826 mm)	13 ft. 10 in. (4216 mm)	12 ft. 6 in. (3810 mm)	10 ft. 11 in. (3327 mm)	17 ft. 4 in. (5283 mm)	15 ft. 1 in. (4597 mm)	13 ft. 9 in. (4191 mm)	12 ft. 0 in. (3658 mm)
		L/180	13 ft. 10 in. (4216 mm)	12 ft. 1 in. (3683 mm)	10 ft. 11 in. (3327 mm)	9 ft. 7 in. (2921 mm)	15 ft. 1 in. (4597 mm)	13 ft. 2 in. (4013 mm)	12 ft. 0 in. (3658 mm)	10 ft. 6 in. (3200 mm)
		L/240	12 ft. 6 in. (3810 mm)	10 ft. 11 in. (3327 mm)	9 ft. 11 in. (3027 mm)	8 ft. 8 in. (2642 mm)	13 ft. 9 in. (4191 mm)	12 ft. 0 in. (3658 mm)	10 ft. 11 in. (3327 mm)	9 ft. 6 in. (2896 mm)
		L/360	10 ft. 11 in. (3327 mm)	9 ft. 7 in. (2921 mm)	8 ft. 8 in. (2642 mm)	7 ft. 7 in. (2311 mm)	12 ft. 0 in. (3658 mm)	10 ft. 6 in. (3200 mm)	9 ft. 6 in. (2896 mm)	8 ft. 4 in. (2540 mm)
4 in. (102 mm)	25 (18 mils)	L/120	19 ft. 1 in. (5817 mm)	15 ft. 11 in. (4851 mm)	13 ft. 10 in. (4216 mm)	11 ft. 3 in. (3429 mm)	19 ft. 7 in. (5969 mm)	15 ft. 11 in. (4851 mm)	13 ft. 10 in. (4216 mm)	11 ft. 3 in. (3429 mm)
		L/180	16 ft. 8 in. (5080 mm)	14 ft. 6 in. (4470 mm)	13 ft. 2 in. (4013 mm)	11 ft. 3 in. (3429 mm)	18 ft. 3 in. (5563 mm)	15 ft. 11 in. (4851 mm)	13 ft. 10 in. (4216 mm)	11 ft. 3 in. (3429 mm)
		L/240	15 ft. 1 in. (4597 mm)	13 ft. 2 in. (4013 mm)	12 ft. 0 in. (3658 mm)	10 ft. 6 in. (3200 mm)	16 ft. 7 in. (5055 mm)	14 ft. 5 in. (4394 mm)	13 ft. 2 in. (4013 mm)	11 ft. 3 in. (3429 mm)
		L/360	13 ft. 2 in. (4013 mm)	11 ft. 6 in. (3505 mm)	10 ft. 6 in. (3200 mm)	9 ft. 2 in. (2794 mm)	14 ft. 5 in. (4394 mm)	12 ft. 8 in. (3861 mm)	11 ft. 6 in. (3505 mm)	11 ft. 3 in. (3429 mm)
4 in. (102 mm)	20 (33 mils)	L/120	21 ft. 8 in. (6604 mm)	18 ft. 11 in. (5766 mm)	17 ft. 2 in. (5232 mm)	15 ft. 0 in. (4572 mm)	23 ft. 8 in. (7214 mm)	20 ft. 8 in. (6299 mm)	18 ft. 9 in. (5715 mm)	15 ft. 6 in. (4724 mm)
		L/180	18 ft. 11 in. (5766 mm)	16 ft. 6 in. (5029 mm)	15 ft. 0 in. (4572 mm)	13 ft. 1 in. (3988 mm)	20 ft. 8 in. (6299 mm)	18 ft. 1 in. (5518 mm)	16 ft. 5 in. (5004 mm)	14 ft. 4 in. (4369 mm)
		L/240	17 ft. 2 in. (5232 mm)	15 ft. 0 in. (4572 mm)	13 ft. 8 in. (4166 mm)	11 ft. 11 in. (3632 mm)	18 ft. 9 in. (5715 mm)	16 ft. 5 in. (5004 mm)	14 ft. 11 in. (4547 mm)	13 ft. 0 in. (3962 mm)
		L/360	15 ft. 0 in. (4572 mm)	13 ft. 1 in. (3988 mm)	11 ft. 11 in. (3632 mm)	10 ft. 5 in. (3175 mm)	16 ft. 5 in. (5004 mm)	14 ft. 4 in. (4369 mm)	13 ft. 0 in. (3962 mm)	11 ft. 5 in. (3490 mm)
6 in. (152 mm)	25 (18 mils)	L/120	22 ft. 7 in. (6883 mm)	18 ft. 9 in. (5715 mm)	16 ft. 3 in. (4953 mm)	12 ft. 0 in. (3658 mm)	22 ft. 11 in. (6985 mm)	18 ft. 9 in. (5715 mm)	16 ft. 3 in. (4953 mm)	12 ft. 0 in. (3658 mm)
		L/180	19 ft. 9 in. (6020 mm)	17 ft. 3 in. (5258 mm)	15 ft. 8 in. (4775 mm)	12 ft. 0 in. (3658 mm)	21 ft. 8 in. (6604 mm)	18 ft. 9 in. (5715 mm)	16 ft. 3 in. (4953 mm)	12 ft. 0 in. (3658 mm)
		L/240	17 ft. 11 in. (5461 mm)	15 ft. 8 in. (4775 mm)	14 ft. 3 in. (4343 mm)	12 ft. 0 in. (3658 mm)	19 ft. 8 in. (5994 mm)	17 ft. 2 in. (5232 mm)	15 ft. 7 in. (4750 mm)	12 ft. 0 in. (3658 mm)
		L/360	15 ft. 8 in. (4775 mm)	13 ft. 8 in. (4166 mm)	12 ft. 5 in. (3785 mm)	10 ft. 10 in. (3302 mm)	17 ft. 2 in. (5232 mm)	15 ft. 0 in. (4572 mm)	13 ft. 8 in. (4166 mm)	11 ft. 11 in. (3632 mm)
6 in. (152 mm)	20 (33 mils)	L/120	27 ft. 4 in. (8331 mm)	23 ft. 11 in. (6985 mm)	21 ft. 8 in. (6604 mm)	19 ft. 0 in. (5791 mm)	30 ft. 0 in. (9144 mm)	26 ft. 2 in. (7976 mm)	23 ft. 7 in. (7188 mm)	19 ft. 3 in. (5867 mm)
		L/180	23 ft. 11 in. (6985 mm)	21 ft. 11 in. (6680 mm)	19 ft. 0 in. (5791 mm)	16 ft. 7 in. (5055 mm)	26 ft. 2 in. (7976 mm)	22 ft. 11 in. (6985 mm)	20 ft. 9 in. (6325 mm)	18 ft. 2 in. (5537 mm)
		L/240	21 ft. 8 in. (6604 mm)	19 ft. 0 in. (5791 mm)	17 ft. 3 in. (5258 mm)	15 ft. 1 in. (4597 mm)	23 ft. 9 in. (7239 mm)	20 ft. 9 in. (6325 mm)	18 ft. 11 in. (5766 mm)	16 ft. 6 in. (5029 mm)
		L/360	19 ft. 0 in. (5791 mm)	16 ft. 7 in. (5055 mm)	15 ft. 1 in. (4597 mm)	13 ft. 2 in. (4013 mm)	20 ft. 9 in. (6325 mm)	18 ft. 2 in. (5537 mm)	16 ft. 6 in. (5029 mm)	14 ft. 5 in. (4394 mm)

Maximum Section Properties

Based on AISI Specifications for the Design of Cold-Formed Steel Structural Members.

C-T Stud Size	T	W	A	I _x	S _x (C)	S _x (T)
2-1/2 in. (64 mm) – 25 gauge (18 mils)	0.0179	0.470	0.118	0.132	0.095	0.118
2-1/2 in. (64 mm) – 20 gauge (33 mils)	0.0329	0.820	0.218	0.242	0.175	0.217
4 in. (102 mm) – 25 gauge (18 mils)	0.0179	0.580	0.145	0.374	0.171	0.207
4 in. (102 mm) – 20 gauge (33 mils)	0.0329	1.020	0.267	0.687	0.341	0.380
6 in. (152 mm) – 25 gauge (18 mils)	0.0179	0.715	0.181	0.957	0.299	0.347
6 in. (152 mm) – 20 gauge (33 mils)	0.0329	1.260	0.333	1.759	0.543	0.637

T = Minimum Uncoated Base Steel Thickness (in)
W = Weight (pounds per linear ft)

A = Sectional Area (in)
I_x = Moment of Inertia (in)

S_x(C) = Section Modulus 'C' flange (in)
S_x(T) = Section Modulus 'T' flange (in)

Door Frame Details

Important: Illustrations are not intended for design or specification purposes.

There are numerous elevator and stairwell door frame combinations and special conditions that cannot be detailed beyond general conditions in this catalog. The interface of the shaftwall system and door frame should be addressed in the shop drawings of the elevator and/or frame manufacturer literature.

- A. C-T, C-H or I studs 24 in. (610 mm) o.c.
- B. Pan head screws on both sides of door framing
- C. J track - 20 (33 mils) or 25 gauge (18 mils), as required
- D. Intersection Details
- E. Gypsum board filler strips may be required where jambs are in place prior to walls to allow proper fastening of gypsum board J track
- F. 20-gauge (33 mils) J track
- G. 20-gauge (33 mils) J track screwed to jamb anchor clips
- H. Solid gypsum board filler strips as required for frames
- I. 1 in. (25.4 mm) DensGlass® Shaftliner panel
- J. 1/2 in. (12.7 mm) DensArmor Plus® Fireguard C® interior panel or 1/2 in. (12.7 mm) ToughRock® Fireguard C® gypsum board, or 5/8 in. (15.9 mm) ToughRock® Fireguard X® gypsum board or 5/8 in. (15.9 mm) DensArmor Plus® Interior Panel.
- K. Acoustical Sealant
- L. Power actuated fasteners 24 in. (610 mm) o.c.

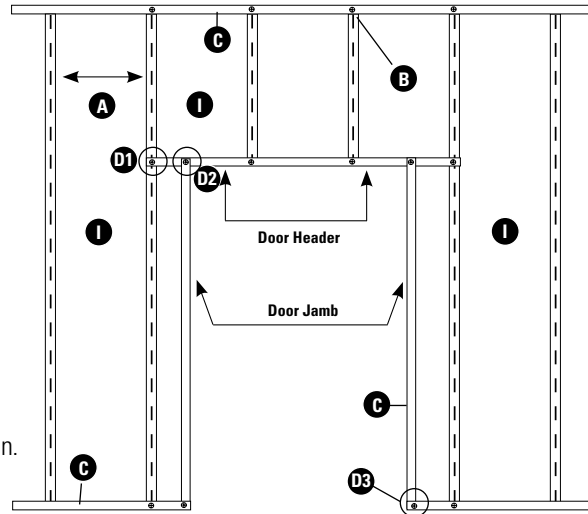

Door Header

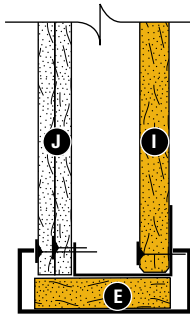

Door Jamb, Typical

Shaftwall

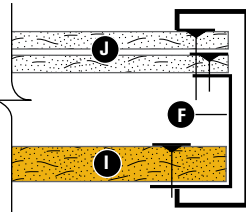

Stairwell

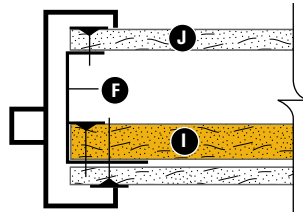

Door Jamb, Typical with Jamb Anchor Clips

Shaftwall

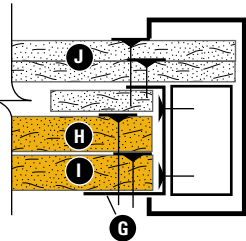

Stairwell

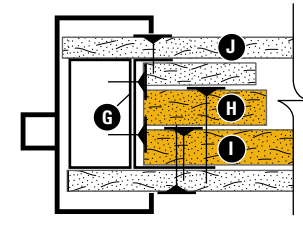

Intersection Details

Detail 1 (D1)

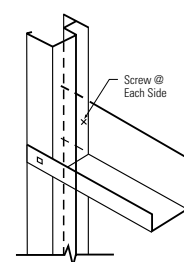

Detail 2 (D2)

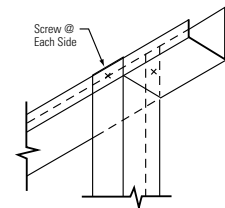

Detail 3 (D3)

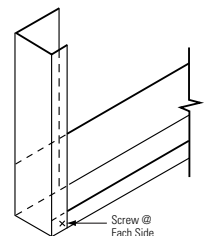

Top of Wall

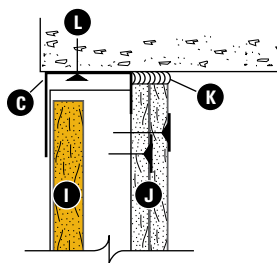

Base of wall

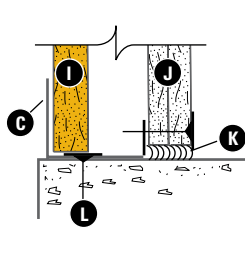

Wall Frame Details

- A. Alternate to bending tabs: use 1-5/8 in. (41 mm) Type S screws at 24 in. (610 mm) o.c.
- B. Tabs in J track bent out at 24 in. (610 mm), alternate to using screws
- C. J track - 20 (33 mils) or 25 (18 mils) gauge
- D. Shaftliner attached to J track prior to installation.
- E. Metal C stud or J track where span is over 24 in. (610 mm), alternate to using screws
- F. Spray-on fireproofing
- G. 1/2 in. (12.7 mm) DensArmor Plus® Fireguard C® or 1/2 in. (12.7 mm) ToughRock® Fireguard C® Gypsum Board, or 5/8 in. (15.9 mm) ToughRock® Fireguard X® Gypsum Board or 5/8 in. (15.9 mm) DensArmor Plus® Interior Panel.
- H. 1 in. (25.4 mm) DensGlass® Shaftliner Panel
- I. Acoustical Sealant
- J. Control joint
- K. Corner bead
- L. Column

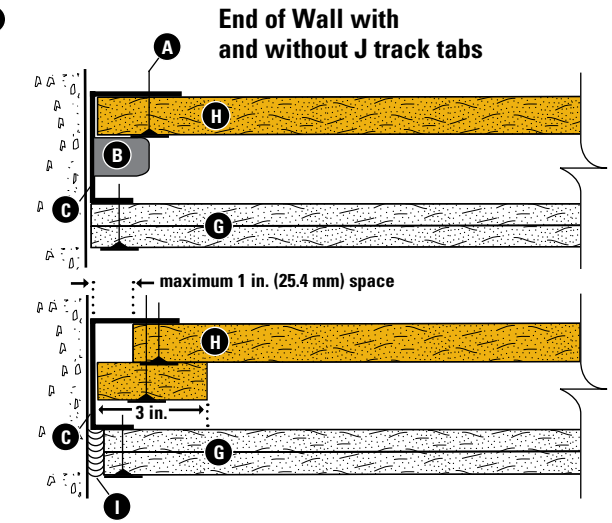
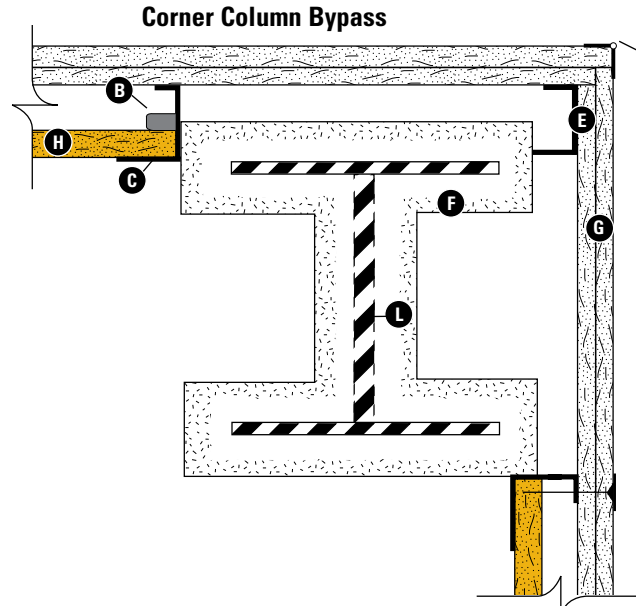
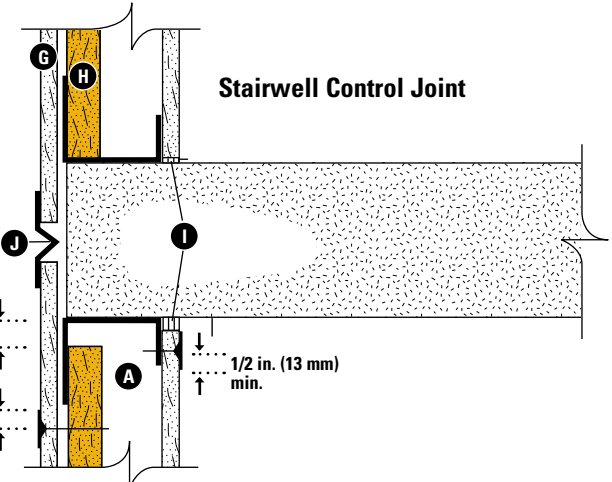
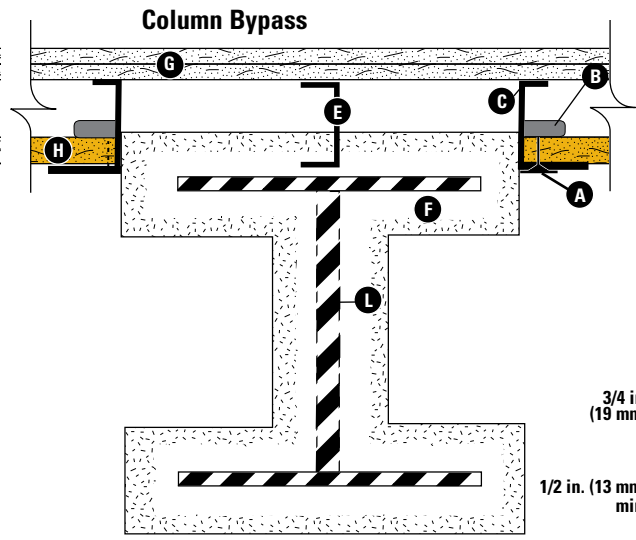
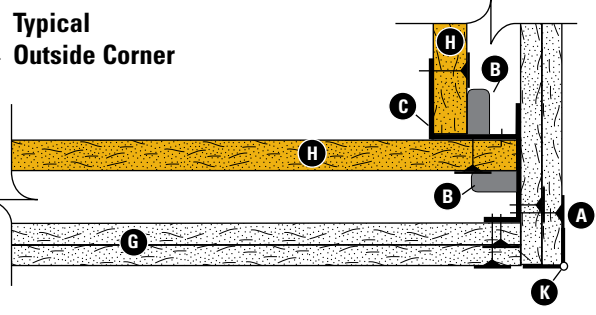
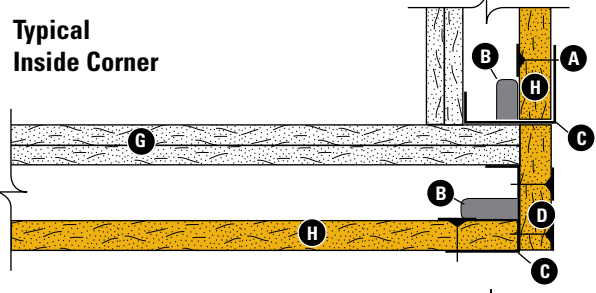

CAUTION: For product fire, safety and use information, go to buildgp.com/safetyinfo.

Rails/Chute/Beam Details

- A. 1 in. (25.4 mm) DensGlass® Shaftliner Panel
- B. Additional 1 in. (25.4 mm) DensGlass® Shaftliner Panel, inside or outside item A
- C. 1/2 in. (12.7 mm) DensArmor Plus® Fireguard C® or 1/2 in. (12.7 mm) ToughRock® Fireguard C® Gypsum Board, or 5/8 in. (15.9 mm) ToughRock® Fireguard X® Gypsum Board or 5/8 in. (15.9 mm) DensArmor Plus® Interior Panel.
- D. Typical call indicator box
- E. Spray-on fireproofing
- F. Fasteners 24 in. (610 mm) o.c.
- G. J track
- H. Handrail
- I. 6 in. (152 mm) wide 16-gauge (54 mils) steel backing plate screwed to studs
- J. Steel offset plate
- K. Steel beam

Call Box/Outlet Box/Mail Chute

4 in. (102 mm) minimum height behind box and screw attached to tabs or flanges of C-T studs or J track.

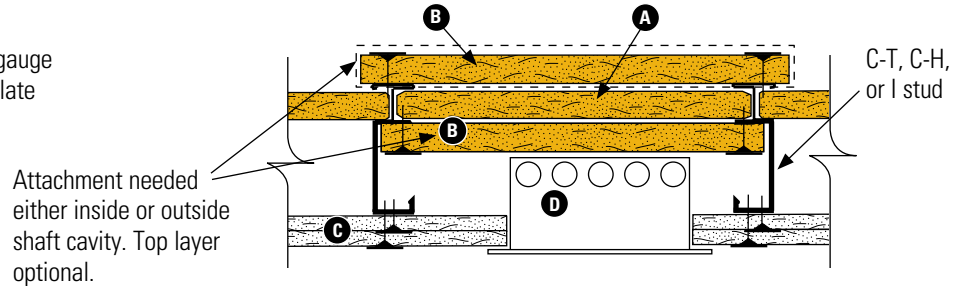

Steel Beam

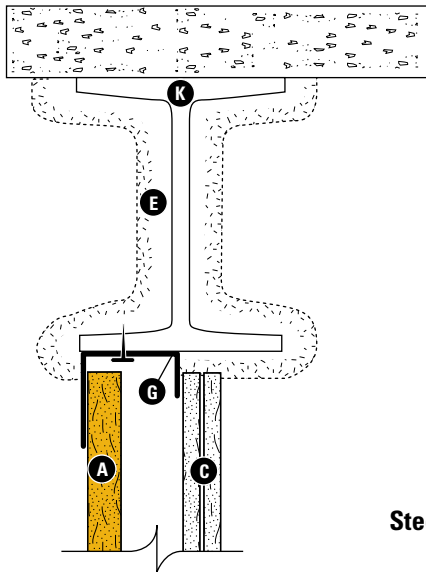

Heavy-Duty Handrail

Backing for attachment of a wide variety of items in commercial and industrial usage, typically uses 16-gauge (54 mils) steel strips attached to the framing. Special loads should be given particular attention.

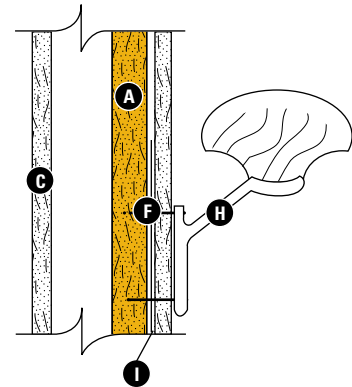

Steel Beam Offset

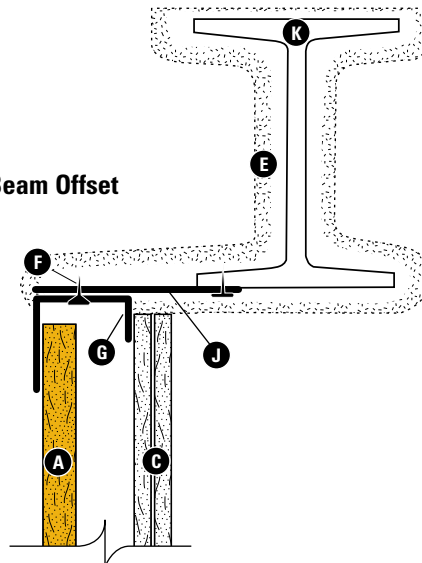

HVAC Duct Detail

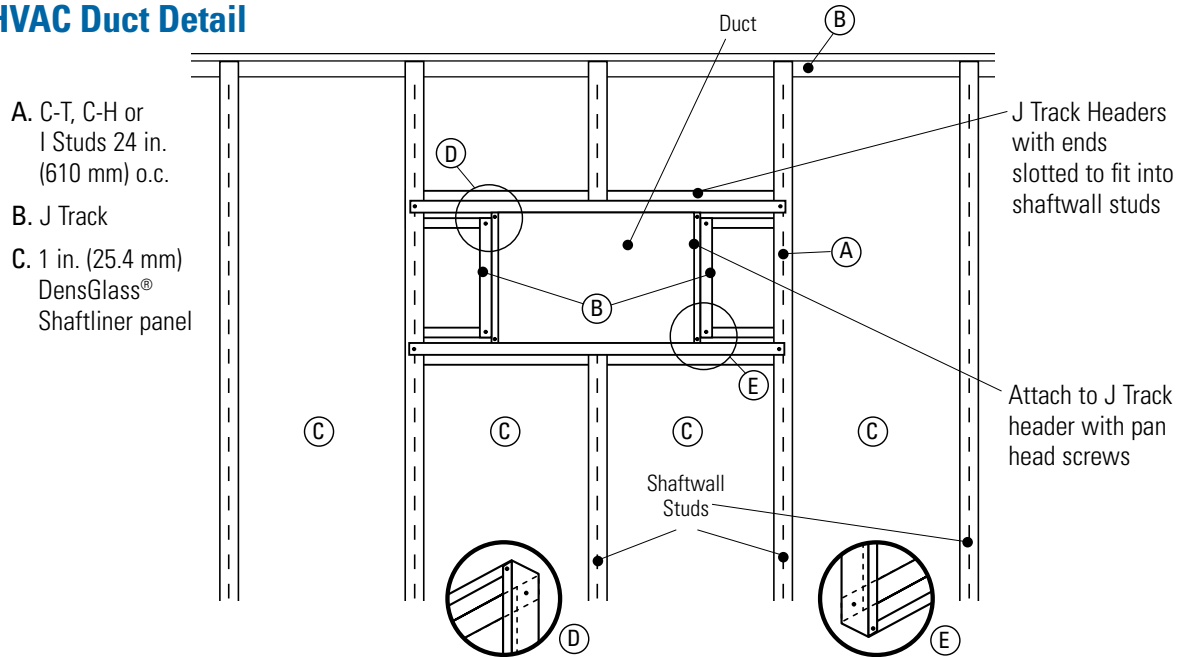

Delivery, Handling and Storage

All materials shall be delivered in original bundles bearing the brand name, if any; applicable standard designation; and name of the manufacturer or supplier from whom the product is manufactured. The plastic packaging used to wrap gypsum panel products for rail and/or truck shipment is intended to provide temporary protection from moisture exposure during transit only and is not intended to provide protection during storage after delivery. Such plastic packaging shall be removed immediately upon receipt of the shipment. **WARNING:** Failure to remove protective plastic shipping covers can result in condensation which can lead to damage, including mold.

All materials should be kept dry. Gypsum panel products shall be neatly stacked flat with care taken to prevent sagging or damage to edges, ends and surfaces. Gypsum panel products and accessories shall be properly supported on risers on a level platform, and fully protected from weather, direct sunlight exposure, and condensation. Gypsum panel products shall be stacked flat rather than on edge or end. **WARNING:** Gypsum panel products stacked on edge or end can be unstable and present a serious hazard in the workplace should they accidentally topple.

Refer to Handling Gypsum Panel Products, GA-801, for proper storage and handling requirements.

Reference: Application and Finishing of Gypsum Panel Products, GA-216, Gypsum Association.

Recommendations and Limitations for Use

The following limitations together with the installation, handling, storage and other guidelines and recommendations contained in this guide are important to ensure the proper use of DensGlass® Shaftliner. Failure to adhere to such recommendations and limitations may void the limited warranty provided by Georgia-Pacific Gypsum for such product. For additional details, please go to www.buildgp.com/warranties and select DensGlass® Shaftliner for warranty information.

- Non-load-bearing.
- Can be used as exhaust ducts where temperatures do not exceed 125°F (52°C).
- Not to be used as an unlined air supply duct.
- Not designed for exposure to constant high-moisture conditions or direct water after building is complete.
- Elevator door assemblies require support independent of shaftwall partitions.
- Good construction practice calls for partition control joints to coincide with that of the building structure.
- Limiting loads and heights not to exceed design specification or data provided herein or by metal component supplier.
- Provide flexible sealant/caulk at partition perimeters and penetrations to avoid air leakage/whistling and dust collection.

High-Performance Gypsum Products from Georgia-Pacific

DensDeck® Roof Board	Fiberglass mat roof board used as the ideal thermal barrier and cover board to improve resistance to wind uplift, hail, foot traffic, fire and mold in a broad range of commercial roofing applications. Look for DensDeck® Prime Roof Board and DensDeck® StormX™ Roof Board.
DensGlass® Sheathing	The original and universal standard of exterior gypsum sheathing offers superior weather resistance, with a 12-month limited warranty against delamination or deterioration during exposure to normal weather conditions. Look for the familiar GOLD color. UL Environmental claim validation for mold resistance.
DensGlass® Shaftliner	These specially-designed panels are perfect for moisture-prone vertical or horizontal shafts, interior stairwells and area separation wall assemblies. 12-month limited warranty against delamination or deterioration during exposure to normal weather conditions. UL Environmental claim validation for mold resistance.
DensArmor Plus® Interior Panel	High-performance interior panel accelerates scheduling because it can be installed before the building is dried-in. A 12-month limited warranty against delamination or deterioration during exposure to normal weather conditions. GREENGUARD and GREENGUARD Gold certified for low VOC emissions. UL Environmental claim validation for mold resistance.
DensShield® Tile Backer	Acrylic-coated tile backer stops moisture at the surface. Lightweight and strong, they are built for speed on the job site. Conforms to requirements of IBC/IRC Code. UL Environmental claim validation for mold resistance.
ToughRock® Gypsum Board	Paper-faced line of gypsum panels for a variety of applications including interior wall and ceiling applications and panels for use in fire-rated assemblies. ToughRock® Products are GREENGUARD and GREENGUARD Gold certified for low VOC emissions.
ToughRock® Mold-Guard™ Gypsum Board	ToughRock® Mold-Guard™ Gypsum Board products have enhanced mold resistance in comparison to regular ToughRock® Gypsum Boards. They are GREENGUARD and GREENGUARD Gold Certified for low VOC emissions. The ToughRock® Mold-Guard™ Gypsum Board has UL Environmental claim validation for mold resistance.
DensElement® Barrier System	DensElement® Barrier System delivers the same advantages of DensGlass® Sheathing while incorporating AquaKOR™ Technology, a water barrier system that maintains high vapor permeability mitigating the risk of moisture in the wall cavity. With this innovation built into its core, DensElement® Barrier System eliminates the need for additional barrier (WRB-AB) saving time, labor and materials.



Georgia-Pacific
Gypsum

U.S.A. GP Gypsum LLC
Canada Georgia-Pacific Canada LP

SALES INFORMATION AND ORDER PLACEMENT

U.S.A.	Northeast:	1-800-947-4497
	Southeast:	1-800-327-2344
	Pacific Southwest:	1-800-824-7503
	Pacific Northwest:	1-800-444-0092
	Midwest:	1-800-876-4746
	Central:	1-800-231-6060 x 7709
CANADA	Eastern Canada:	1-800-387-6823
	Western Canada:	1-800-558-0092

TECHNICAL HOTLINE

U.S.A. and Canada: **1-800-225-6119**



TRADEMARKS –

Unless otherwise noted, all trademarks are owned by or licensed to Georgia-Pacific Gypsum LLC. LEED, USGBC and related logo are trademarks owned by the U.S. Green Building Council and are used by permission. CHPS is a trademark owned by Collaborative for High Performance Schools Inc.

WARRANTIES, REMEDIES AND TERMS OF SALE –

For current warranty information, please go to www.buildgp.com/warranties and select the applicable product. All sales by Georgia-Pacific are subject to our Terms of Sale available at www.buildgp.com/tc.

UPDATES AND CURRENT INFORMATION –

The information in this document may change without notice. Visit our website at www.buildgp.com for updates and current information.

CAUTION: For product fire, safety and use information, go to buildgp.com/safetyinfo or call 1-800-225-6119.

HANDLING AND USE –

CAUTION This product contains fiberglass facings which may cause skin irritation. Dust and fibers produced during the handling and installation of the product may cause skin, eye and respiratory tract irritation. Avoid breathing dust and minimize contact with skin and eyes. Wear long sleeve shirts, long pants and eye protection. Always maintain adequate ventilation. Use a dust mask or NIOSH/MSHA approved respirator as appropriate in dusty or poorly ventilated areas.

FIRE SAFETY CAUTION –

Passing a fire test in a controlled laboratory setting and/or certifying or labeling a product as having a one-hour, two-hour, or any other fire resistance or protection rating and, therefore, as acceptable for use in certain fire rated assemblies/systems, does not mean that either a particular assembly/system incorporating the product, or any given piece of the product itself, will necessarily provide one-hour fire resistance, two-hour fire resistance, or any other specified fire resistance or protection in an actual fire. In the event of an actual fire, you should immediately take any and all actions necessary for your safety and the safety of others without regard for any fire rating of any product or assembly/system.

buildgp.com