



***Accessory Products***





## Scaffolds Series

**NU-WAVE**  
SCAFFOLDING SYSTEMS

### Classic

#### Model #660

69-1/2" Ladders, 6' Platform and Trusses

- Scaffold components made in the USA
- Easy Set Up
- Load Capacity of 1000 lbs.
- Rolls through standard door openings
- All Steel Construction
- Adjusts in 4" increments



| Prod# | Description            | Ship Wt. |
|-------|------------------------|----------|
| 48545 | 660 Classic With PIC-5 | 145      |

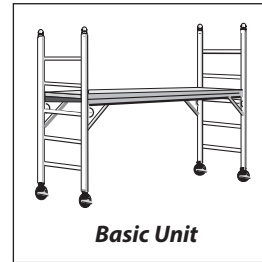

## Scaffold Parts and Accessories

**NU-WAVE**  
SCAFFOLDING SYSTEMS

### Guardrail Kits

For your safety, always use guardrails at any working height. They are recommended equipment when using any scaffold.

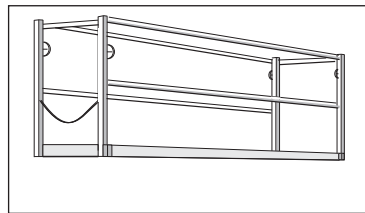

| Product # | Model # | Description                              | Ship Wt. |
|-----------|---------|--|----------|
| 48660     | GK-6    | Guardrail Kit—6 ft. Scaffold 2-GR2&2-GR6 | 68       |

### Plywood Platform

5/8 inch thick plywood with 1/32 inch galvanized banding. The banding is fixed to the plywood to provide permanent protection.

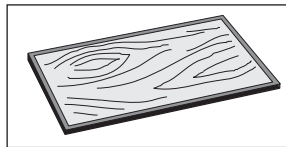

| Product# | Model# | Description                    | Ship Wt. |
|----------|--------|--------------------------------|----------|
| 49015    | PP-6CL | Classic 6 ft. (28.5" x 70.25") | 24       |

\* Locking Platform

### Casters

INDY CASTERS feature a unique self-adjusting locking mechanism. A streamlined lever design permits 360 degree wheel rotation.

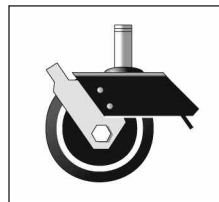

PIC-5

| Product# | Model# | Description                       | Ship Wt. |
|----------|--------|-----------------------------------|----------|
| 49040    | PIC-5  | 5" INDY Caster-Swivel&Wheel Brake | 5        |



## Mini-Scaffolds

### Model SU-4

#### 4 Ft. Step-Up® Portable Mini-Scaffold

With its sturdy 1" O.D. tubular construction, 500 lb. load capacity and 50" height, the SU-4 is perfect for all low ceiling jobs. The SU-4 comes with 5" INDY All Brake Casters which permit 360 degree wheel rotation for ease of movement. Folds down to just 22" wide.



| Prod# | Description  | Load Cap | Ship Wt. |
|-------|--|----------|----------|
| 48035 | 4 ft. Step-Up Mini-Scaffold with 4 #PC54B-5" all brake casters<br>51.5" high x 48" long x 22" wide | 500      | 70       |

### Model SU-5

#### 5 Ft. Step-Up® Portable Mini-Scaffold

Throw away those bulky, shaky ladders, A-frames and planks! Whatever job you're up to, the SU-5 will help you do it faster, safer and easier. The SU-5 is adjustable to four convenient working heights, has a 600 lb. load capacity, and features INDY All Brake Casters.



| Prod# | Description  | Load Cap | Ship Wt. |
|-------|--|----------|----------|
| 48037 | 5 ft. Step-Up Mini-Scaffold with 4 #PC54B-5" all brake casters<br>61.5" high x 56" long x 25" wide | 600      | 90       |

### Model SU-6

#### 6 Ft. Step-Up® Portable Mini-Scaffold

By popular demand...a taller version of Nu-Wave's Step-Up Utility Work Stand! Like all of Nu-Wave's Mini-Scaffolds, the SU-6 sets up in seconds with no assembly required. Adjusts to six working heights up to six feet. Features include "high tech" cushion rubber locking swivel INDY casters and big 600 lb. load capacity.



| Prod# | Description  | Load Cap | Ship Wt. |
|-------|--|----------|----------|
| 48039 | 6 ft. Step-Up Mini-Scaffold with 4 #PC54B-5" all brake casters<br>72" high x 56" long x 25" wide | 600      | 100      |



## Drywall Carts

**NU-WAVE**  
SCAFFOLDING SYSTEMS

### Model PD-1 Residential Drywall Cart

This residential drywall cart has a streamline design, ergonomic handle, and is lightweight.

- 2000 lb. load capacity
- 17.25" wide x 47" high x 39.25" long

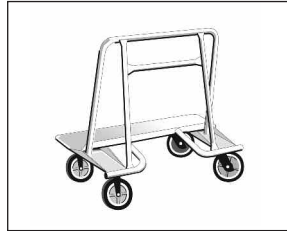

| Product # | Model # | Description     | Ship Wt. |
|-----------|---------|-----------------|----------|
| 49090     | PD-1    | Without Casters | 50       |

### Model PD-2

For most applications, this economical model is all you need to do the job. Two wheels are fixed position for straight ahead movement. Two wheels swivel for turning. Like all the other drywall carts, it's built to last with quality.

- 3,000 lb. load capacity
- 22" wide x 47" high x 43.625" long



| Product # | Model # | Description     | Ship Wt. |
|-----------|---------|-----------------|----------|
| 49100     | PD-2    | Without Casters | 50       |

### Model PD-4

This model features a special inset back tube frame. It provides maximum maneuverability around tight corners or through standard doorways with four swivel casters. Optional position locks keep two wheels straight when moving one direction.

- 3,000 lb. load capacity
- 25" wide x 47" high x 49.75" long



| Product # | Model # | Description     | Ship Wt. |
|-----------|---------|-----------------|----------|
| 49240     | PD-4    | Without Casters | 75       |

## INDY Casters for Drywall Carts

**NU-WAVE**  
SCAFFOLDING SYSTEMS

Custom built for Nu-Wave, these are the strongest, longest-lasting casters in the industry. All wheels are 8" x 2". The frame features an all heat-treated bearing race with celcon seals. A unique new king pin design spreads stress points for longer-lasting caster frames.

| Product # | Model #   | Description              | Unit | Ship Wt. |
|-----------|-----------|--------------------------|------|----------|
| 49337     | PCHTS-8-S | 8" Swivel Hi-Tech Caster | EA   | 6        |

### Hi-Tech Silverline

- rolls easily-very durable
- protects floors, rejects floor debris
- low temperature flexibility
- chemical, steam and water resistant
- 2400 lb. capacity





## TRIGGER Benches and Platforms

### Aluminum Bench

- Heavy-duty aluminum
- Solid rivet construction
- Non-slip foot pads
- Heavy-duty aluminum spreader hinges

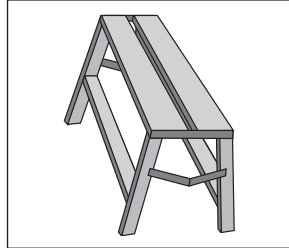

| Prod # | Size         | Qty/Unit | Unit | Wt/Unit |
|--------|--------------|----------|------|---------|
| 71135  | 30"L x 24" H | 1        | EA   | 10      |
| 71140  | 30"L x 30" H | 1        | EA   | 12      |
| 71145  | 30"L x 36" H | 1        | EA   | 15      |
| 71150  | 30"L x 48" H | 1        | EA   | 20      |
| 71152  | 30"L x 60" H | 1        | EA   | 25      |
| 71153  | 30"L x 72" H | 1        | EA   | 30      |

### Fat Top

- 9-1/2" Top Step
- Meets all OSHA requirements for under 4'
- Heavy-duty bolted hinge and spreader
- 3" Step
- Heavy-duty 1A 300lb. Rating

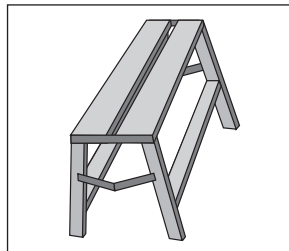

| Prod # | Size         | Qty/Unit | Unit | Wt/Unit |
|--------|--------------|----------|------|---------|
| 71180  | 30"L x 24" H | 1        | EA   | 12      |
| 71185  | 30"L x 30" H | 1        | EA   | 14      |
| 71190  | 30"L x 36" H | 1        | EA   | 17      |
| 71195  | 30"L x 48" H | 1        | EA   | 24      |

### Extendible Plank

- Heavy-duty aluminum
- Solid rivet construction
- 4 sizes, expands from 6' to 9', 7' to 11', 8' to 13' and 10' to 16'

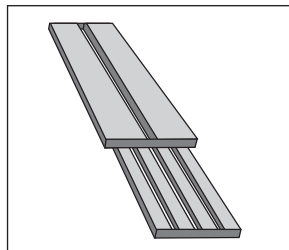

| Prod # | Size      | Qty/Unit | Unit | Wt/Unit |
|--------|-----------|----------|------|---------|
| 71160  | 7' - 11'  | 1        | EA   | 42      |
| 71165  | 8' - 13'  | 1        | EA   | 48      |
| 71167  | 10' - 16' | 1        | EA   | 55      |



## Respirators

### 3M Particulate Respirator 8210 Plus, N95

- NIOSH approval: N95
- Recommended for sanding and working with fiberglass insulation and drywall sanding
- Adjustable nose clip helps provide a custom fit, a secure seal and reduces eyewear fogging

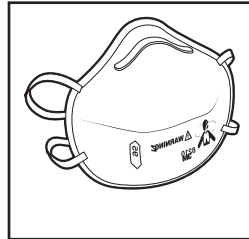

| Prod# | Qty/Box | Box/Ctn | Unit | Wt/Ctn |
|-------|---------|---------|------|--------|
| 62020 | 20      | 4       | CTN  | 2.8    |

### 3M Particulate Respirator 8511, N95

- NIOSH approval: N95
- Recommended for sanding and working with fiberglass insulation and drywall sanding
- Cool flow exhalation valve allows easy exhalation and heat reduction, which provides cool, dry comfort

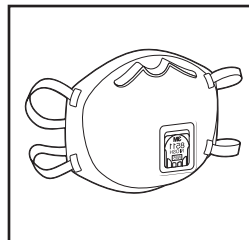

| Prod# | Qty/Box | Box/Ctn | Unit | Wt/Ctn |
|-------|---------|---------|------|--------|
| 62040 | 10      | 4       | CTN  | 3      |

## Abrasives



## Sanding Sponges

### Sanding Sponges

- Small area sponge for wet or dry sanding
- Rinse and reuse
- Ideal for sanding wood, paint, metal, plastic or drywall
- Two sanding grades on one sponge



| Prod# | Model# | Desc        | Pcs/Ctn | Unit | Wt/Ctn |
|-------|--------|-------------|---------|------|--------|
| 61400 | #908   | Fine/Medium | 24      | CTN  | 2      |

Size: 2-5/8" X 3-3/4" X 1"

### Detail Area/Angled Sanding Sponges

- Use either wet or dry and when finished, rinse and reuse
- Designed to sand corners without affecting adjacent walls or textured ceilings
- Medium (80 grit) and Fine (120 grit)



| Prod# | Model# | Desc   | Pcs/Ctn | Unit | Wt/Ctn |
|-------|--------|--------|---------|------|--------|
| 61720 | #CP041 | Medium | 24      | CTN  | 3      |
| 61730 | #CP040 | Fine   | 24      | CTN  | 3      |

Size: 2-7/8" X 4-7/8" X 1"

## Sandpaper and Sanding Screens



### Smooth-Kut Paper

Available in 80 grit to 150 grit grades, this sandpaper features D-weight backing for strength with flexibility and longer life in drywall finishing. The 4 3/16" x 11" sheets actually measure 11-1/4" in length for improved mounting on pole sanders.



| Prod# | Model# | Grit     | Sht/Box | Box/Ctn | Unit | Wt/Ctn |
|-------|--------|----------|---------|---------|------|--------|
| 52070 | B0308  | 80 grit  | 100     | 10      | CTN  | 34     |
| 52080 | B0307  | 100 grit | 100     | 10      | CTN  | 29     |
| 52090 | B0306  | 120 grit | 100     | 10      | CTN  | 26     |
| 52100 | B0305  | 150 grit | 100     | 10      | CTN  | 26     |

### Wet-Kut Waterproof Cloth

100 percent waterproof, this strong J-weight cloth is the same material that is used to make "denim" type jeans, thereby giving it unsurpassed durability in the abrasive field. It is ideal for "wet sanding", and can be washed off if loading occurs. The 3 5/16" x 12" sheets fit sanders without trimming, and easily mount on pole and hand sanders.

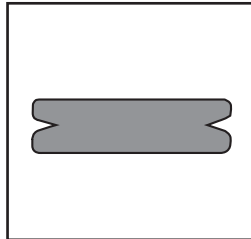

| Prod# | Model# | Grit     | Sht/Box | Box/Ctn | Unit | Wt/Ctn |
|-------|--------|----------|---------|---------|------|--------|
| 52130 | B0905  | 100 grit | 25      | 10      | CTN  | 21     |
| 52135 | B0904  | 120 grit | 25      | 10      | CTN  | 21     |
| 52140 | B0903  | 150 grit | 25      | 10      | CTN  | 21     |
| 52145 | B0902  | 180 grit | 25      | 10      | CTN  | 21     |
| 52147 | B0901  | 240 grit | 25      | 10      | CTN  | 21     |

## Sanding Sponges



### Sanding Sponges

Compact and flexible abrasive coated sponges are convenient and economical for general sanding of drywall, wood and metal surfaces. Featuring dual-grades in either fine (120 grit), medium (80 grit), or coarse (50 grit). Can be rinsed and reused.

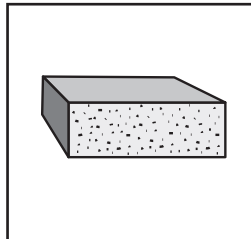

| Prod# | Model# | Desc        | Pcs/Ctn | Unit | Wt/Ctn |
|-------|--------|-------------|---------|------|--------|
| 52110 | B1101D | Fine/Medium | 30      | CTN  | 2.3    |

Size: 3-3/4" x 2-3/4" x 1"

### Dual Angled Sanding Sponges

Large flexible abrasive sponges feature two 75 degree beveled sides and fine/medium grading for multi-purpose use. Suitable for general sanding of flat or contoured surfaces as well as allowing sanding into corners or up to trim and moldings.

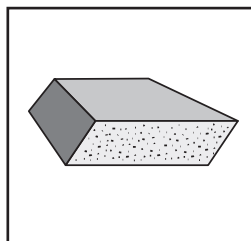

| Prod# | Model# | Grit        | Pcs/Ctn | Unit | Wt/Ctn |
|-------|--------|-------------|---------|------|--------|
| 52125 | B1107  | Fine/Medium | 24      | CTN  | 2.5    |

Size: 5" x 3" x 1"





## Masking Tape

### #2020 General Purpose Masking Tape

- For general purpose masking
- High adhesion for good holding power
- Provides good paint lines
- 1 day clean removal



**Bulk pack.**

| Prod# | Width  | Rls/Ctn | Unit | Wt/Ctn |
|-------|--------|---------|------|--------|
| 67032 | 1"     | 36      | CTN  | 14     |
| 67034 | 1-1/2" | 24      | CTN  | 14     |
| 67036 | 2"     | 24      | CTN  | 17     |

### #2090 SCOTCH Brand Long Mask Masking Tape

- Medium adhesion; UV and sunlight resistant
- Use also on most previously painted surfaces, including painted wallboard
- Excellent for masking exterior glass enameled or varnished woodwork
- IMPROVED! 14 day clean removal

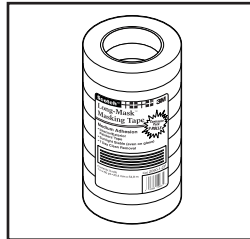

**Bulk pack.**

| Prod# | Width  | Rls/Ctn | Unit | Wt/Ctn |
|-------|--------|---------|------|--------|
| 67050 | 1"     | 36      | CTN  | 14     |
| 67060 | 1-1/2" | 24      | CTN  | 13.5   |
| 67070 | 2"     | 24      | CTN  | 17.6   |

## Poly Duct Tape



### Polyken 827

#### Premium Grade Poly Duct Tape

High-density, polyethylene tape with high shear, conformability, abrasion and chemical resistance, and moisture barrier properties. Sticks to most surfaces, including polyethylene films, and leaves no residue when removed. (2" width, 8 mil.)

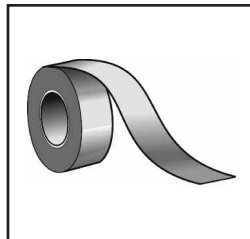

| Prod# | Item | Width | Rolls/Ctn | Ctns/Plt | Unit | Wt/Ctn |
|-------|------|-------|-----------|----------|------|--------|
| 69030 | 827  | 2"    | 24        | 27       | CTN  | 28     |

## Cloth Duct Tape



### Polyken 223

#### Utility Grade Cloth Duct Tape

Featuring patented Kappa Calendar Construction, this utility grade cloth duct tape with high adhesion qualities is excellent for general use. 10 mil thickness. 2" width.

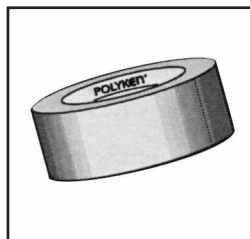

| Prod# | Item | Width | Rolls/Ctn | Ctns/Plt | Unit | Wt/Ctn |
|-------|------|-------|-----------|----------|------|--------|
| 69020 | 223  | 2"    | 24        | 27       | CTN  | 44     |



## Plastic Construction Films



### Plastic Sheeting

Whatever your plastic sheeting need, Poly-America has you covered. Made of high-quality polyethylene, Poly-America Plastic Sheeting delivers unsurpassed durability, performance and versatility every roll, every time.

- \* Polyethylene
- \* Available in a variety of lengths, widths and thicknesses
- \* Suitable for masking, vapor barriers, flashing and more

| Prod# | Item # | Mil | RI Size     | Aprox Wt/RI | Unit | Rls/Pallet |
|-------|--------|-----|-------------|-------------|------|------------|
| 60010 | 109C   | 1   | 9' x 400'   | 17          | RL   | 80         |
| 60030 | 2100C  | 2   | 8'4" x 200' | 16          | RL   | 96         |
| 60040 | 212C   | 2   | 12" x 200'  | 23          | RL   | 64         |
| 60060 | 420C   | 4   | 20' x 100'  | 38          | RL   | 35         |
| 60098 | 620C   | 6   | 20' x 100'  | 57          | RL   | 20         |

### Painter's Plastic (High Density)

Costs less than conventional low-density sheeting. It is thinner, has better tape adhesion, and comes in a convenient dispenser.

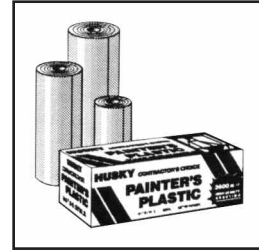

| Prod# | Item # | Mil  | RI Size    | Aprox Wt/RI | Unit | Rls/Pallet |
|-------|--------|------|------------|-------------|------|------------|
| 60092 | 03509H | 0.31 | 9' x 400'  | 6           | RL   | 140        |
| 60093 | 03512H | 0.31 | 12' x 400' | 8           | RL   | 112        |

### Hand Wrap Stretch Film

Essential for all warehouses, Hand Wrap Stretch Film gives you total quality control over your shipping. 80 gauge.

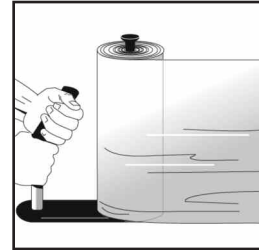

| Prod# | Item #   | RI Size     | Aprox Wt/Ctn | Unit | Rls/Ctn |
|-------|----------|-------------|--------------|------|---------|
| 61010 | HW181580 | 18" x 1500' | 35           | CTN  | 4       |



## Masking Papers, Floor Paper

### Handmasker Masking Paper

A general purpose Kraft paper, suitable for all kinds of masking needs. Packaged in 180 ft. rolls for easy handling.

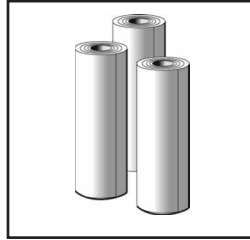

| Prod# | Size | Lgth   | Rolls/Ctn | Unit | Wt/Ctn | Ctns/Pallet |
|-------|------|--------|-----------|------|--------|-------------|
| 58950 | 6"   | 180 ft | 12        | CTN  | 9      | 119         |
| 58960 | 9"   | 180 ft | 12        | CTN  | 14     | 85          |
| 58970 | 12"  | 180 ft | 12        | CTN  | 18     | 68          |
| 58990 | 18"  | 180 ft | 12        | CTN  | 27     | 40          |

### Contractor's Paper

A heavy duty construction paper used to protect floors from spills and over spray.

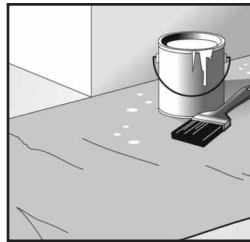

| Prod# | Size | Lgth   | Rolls/Ctn | Unit | Wt/RI | Rls/Pallet |
|-------|------|--------|-----------|------|-------|------------|
| 58900 | 36"  | 166 ft | 1         | RL   | 12    | 80         |

### Floor Paper

A 50 lb. Kraft paper designed to protect large areas from over spray, spills and foot traffic. 3" core.

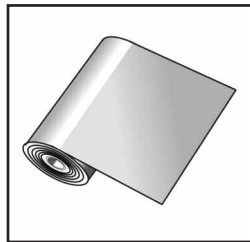

| Prod# | Size | Lgth   | Rolls/Ctn | Unit | Wt/Ctn | Ctns/Pallet |
|-------|------|--------|-----------|------|--------|-------------|
| 58905 | 48"  | 825 ft | 1         | RL   | 55     | 35          |

## Hand Masker Film, Dispenser and Blades



### Pre-folded Masking Film Rolls

- Cut labor spend covering window by 50%!
- Folded film unfolds to sizes between 4' and 12'
- Specially formulated to resist paint flaking during multiple coat application
- One person application using a 3M Handmasker™

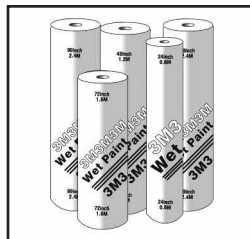

| Prod# | Size       | Rls/Ctn | Unit | Wt/Ctn |
|-------|------------|---------|------|--------|
| 64100 | 48" x 180' | 12      | CTN  | 19     |
| 64110 | 72" x 90'  | 12      | CTN  | 16     |

### M3000 Handmasker™ Dispenser

- Designed for professional contractors
- Simultaneously applies pre-folded masking film or paper with masking tape to cover and protect
- Designed for heavy duty masking

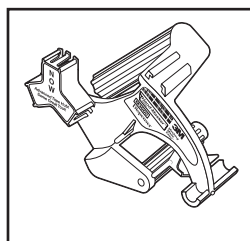

| Prod# | Model# | Pcs/Ctn | Unit | Wt/Ctn |
|-------|--------|---------|------|--------|
| 62500 | M3000  | 4       | CTN  | 6      |



## Adhesives & Sealants



### F-38 Green Series

#### Drywall Construction Adhesive

Professional grade, latex based construction adhesive designed for drywall and other panel applications. This ultra-low VOC product offers fast strength development and high shear strength.



| Prod# | Size        | Tubes/Ctn | Units/Pallet | Unit | Wt/Unit |
|-------|-------------|-----------|--------------|------|---------|
| 54032 | 28 oz. Tube | 12        | 60           | CTN  | 34      |

#### Specifications:

- Tested per ASTM E 72 — Racking Load Evaluation of Sheathing Materials on a Standard Wood Frame
- GreenGuard® certified and Qualifies for LEED® points
- Meets and conforms to the performance characteristics of ASTM C 557
- Complies to the following VOC regulations: SCAQMD Rule 1168 VOC, CARB, BAAQMD

### SC-175 Green Series

#### Sound Sealant

A non-flammable, latex-based sealant specially designed to reduce sound transmissions and drafts in all types of wall systems where a sound-rated assembly is required. The paintable sealant remains flexible and adheres firmly to wood, metal studs, concrete, and most other building materials.



| Prod# | Size        | Tubes/Ctn | Units/Pallet | Unit | Wt/Unit |
|-------|-------------|-----------|--------------|------|---------|
| 54020 | 28 oz. Tube | 12        | 60           | CTN  | 40      |

#### Specifications:

- Tested to or conforms to: ASTM E 84: Surface Burning Characteristics of Building Materials, ASTM E 90-85: Laboratory Measurement of Airborne-Sound Transmission Loss of Building Materials, ASTM D 217: Testing Standard for Consistency, ASTM C 919: Standard Practice for Use of Sealants in Acoustical Applications
- GreenGuard® certified and Qualifies for LEED® points
- Complies to the following VOC regulations: SCAQMD Rule 1168 VOC, CARB, BAAQMD

### FRP-555

#### Latex FRP Panel Adhesive

A high quality, solvent free adhesive for installing fiberglass reinforced panels on common surfaces. Bonds to drywall, wood, concrete, metals, plastic, plastic foams, etc. Long open time with strong yet flexible bond. Nonflammable. Water-resistant.

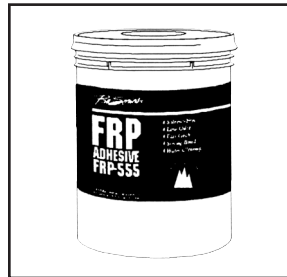

| Prod# | Size     | Units/Pallet | Unit | Wt/Unit |
|-------|----------|--------------|------|---------|
| 54085 | 5 Gallon | 24           | PL   | 63      |

#### Specifications:

- Meets SCAQMD Rule 1168 VOC
- CARB and BAAQMD compliant

## 3M Spray Adhesive



### Super 77 Spray Adhesive

- 220 sq. feet of coverage TWICE as much as the competition
- Used on corner bead where mechanical fasteners are impractical
- Fast, aggressive tack
- Meets California VOC requirements
- Bonds many foils, plastics, papers, foams, metals and cardboard

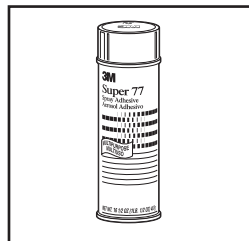

| Prod# | Size    | Cans/Ctn | Unit | Wt/Ctn |
|-------|---------|----------|------|--------|
| 65010 | 16.5 oz | 12       | CTN  | 17.1   |

### High Strength Spray Adhesive 90

- Fast drying contact adhesive
- Bonds high-pressure laminates, woods, particle boards, metals and plastics



| Prod# | Size    | Cans/Ctn | Unit | Wt/Ctn |
|-------|---------|----------|------|--------|
| 65020 | 16.5 oz | 12       | CTN  | 18.2   |



## Self-Adhesive Fiberglass Mesh Tape

### Hamilton Self-Adhesive Fiberglass Mesh Tape

- Individually Shrink Wrapped
- Quick and Easy Installation
- Fiberglass Mesh
- No Shrinking, Bubbling or Stretching
- No Preparing or Stapling
- Made In USA



| Prod# | Roll Size  | Color  | Rolls/Ctn | Unit | Wt/Ctn |
|-------|------------|--------|-----------|------|--------|
| 50015 | *2" X 300' | White  | 24        | CTN  | 20     |
| 50025 | *2" X 300' | Yellow | 24        | CTN  | 20     |

\* Nominal Width (48 mm x 91.4 mm)

|       |               |        |    |     |    |
|-------|---------------|--------|----|-----|----|
| 50040 | 2-1/2" X 300' | Yellow | 24 | CTN | 22 |
| 50060 | 2-1/2" X 300' | Blue   | 24 | CTN | 22 |

**Recommended Use...** Apply first coat over glass mesh tape with Fast Set compound. Subsequent coats may be applied using vinyl based "ready mixed" compounds. Allow to dry between coats.

### Self-Adhesive Custom Quality Mesh Tape

- Individually Shrink Wrapped
- Quick and Easy Installation
- Fiberglass Mesh
- No Shrinking, Bubbling or Stretching
- No Preparing or Stapling



| Prod# | Roll Size  | Color  | Rolls/Ctn | Unit | Wt/Ctn |
|-------|------------|--------|-----------|------|--------|
| 50010 | *2" X 300' | White  | 24        | CTN  | 20     |
| 50020 | *2" X 300' | Yellow | 24        | CTN  | 20     |

\* Nominal Width (48 mm x 91.4 mm)

**Recommended Use...** Apply first coat over glass mesh tape with Fast Set compound. Subsequent coats may be applied using vinyl based "ready mixed" compounds. Allow to dry between coats.

## Caulking

### Hamilton Detail Compound

- Use to detail interior angles
- Low shrinkage and easy sanding
- Paintable



| Prod# | Size     | Tubes/Ctn | Unit | Ship Wt. |
|-------|----------|-----------|------|----------|
| 55100 | 10.1 oz. | 24        | CTN  | 27       |



## Aerosol Spray Texture

### HOMAX Ultra-Fast Drying Orange Peel

- Oil-based formula
- Patches orange peel & splatter textures
- Ultra-fast drying
- Covers up to 110 sq. ft.



| Prod # | Model # | Size   | Cans/Box | Unit | Wt/Bx |
|--------|---------|--------|----------|------|-------|
| 72051  | 4055-06 | 20 oz. | 6        | Bx   | 10    |

### HOMAX Knockdown

- Water-based, low-odor formula
- Sprays multiple patterns
- For patching Southwest or Mediterranean style textures
- Covers up to 60 sq. ft.



| Prod # | Model # | Size   | Cans/Box | Unit | Wt/Bx |
|--------|---------|--------|----------|------|-------|
| 72056  | 4065-06 | 20 oz. | 6        | Bx   | 10.5  |

### HOMAX Color-Changing Orange Peel

- Water-based
- For repairing and patching interior heavy splatter or knockdown drywall textures
- Water clean-up
- Covers up to 90 sq. ft.



| Prod # | Model # | Size   | Cans/Box | Unit | Wt/Bx |
|--------|---------|--------|----------|------|-------|
| 72061  | 4096-06 | 16 oz. | 6        | Bx   | 10    |

*\*Changes color, blue to white.*

### HOMAX Water-Based Orange Peel

- Water-based
- Water cleanup, low odor, fast drying
- Patches orange peel and splatter textures
- Covers up to 110 sq. ft.



| Prod # | Model # | Size   | Cans/Box | Unit | Wt/Bx |
|--------|---------|--------|----------|------|-------|
| 73016  | 4092-06 | 20 oz. | 6        | Bx   | 10.5  |



**Drywall Fasteners**



**Insta-back Fastener**

Insta-back fasteners make drywall repair quick and easy because cutouts can be reattached without cutting drywall back to the nearest stud (as shown in the illustrations below). Insta-backs make finished butt joints that are "bump free", and save time and money by reducing the number of joints to be finished. Meets all building codes and fire ratings.

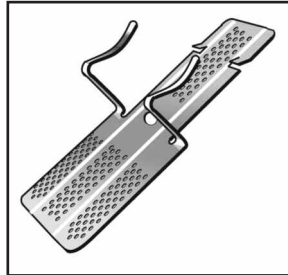

| Prod# | Desc | Pcs/Ctn | Ctn/Pallet | Unit | Wt/Ctn |
|-------|------|---------|------------|------|--------|
| 71010 | 1/2" | 200     | 50         | CTN  | 10     |
| 71020 | 5/8" | 200     | 50         | CTN  | 10     |

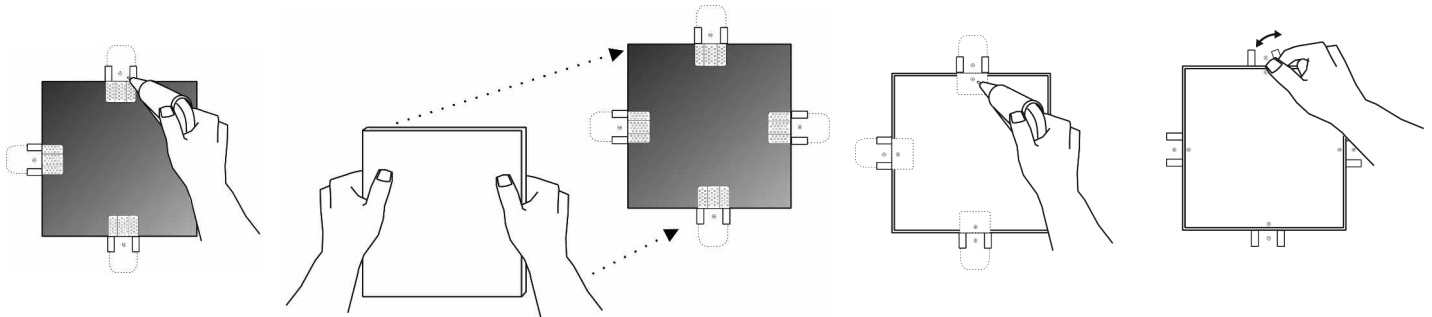

**1.** Place fasteners as shown and secure with drywall screws 3/4" from the edge.

**2.** Replace drywall patch in hole.

**3.** Screw through patch into Insta-back fasteners 3/4" from the edge.

**4.** Bend Insta-back tabs back and forth until they snap off.

**Corner-back Fastener**

Corner-back fasteners save you time, money and materials by allowing you to eliminate one stud at almost every corner. By eliminating the need for corner back-up studs, Corner-backs permit corners to be fully insulated (as shown in the illustration at right). This means a significant reduction in thermal loss. Corner-backs also reduce costly callbacks due to ceiling/partition separation from truss uplift. Meets all building codes and fire ratings.

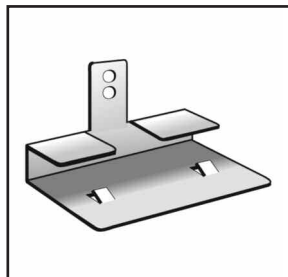

| Prod# | Desc | Pcs/Ctn | Ctn/Pallet | Unit | Wt/Ctn |
|-------|------|---------|------------|------|--------|
| 71030 | 1/2" | 300     | 50         | CTN  | 10     |
| 71040 | 5/8" | 300     | 50         | CTN  | 10     |

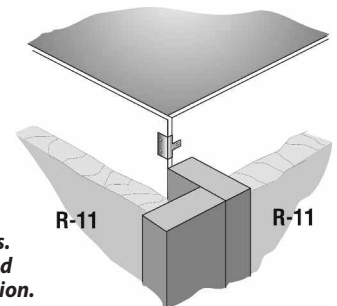

Corner-backs eliminate wood backup at corners and ceilings. The result is faster framing and faster, easier drywall installation.

295 North Pekin Road | Woodland, Washington 98674

Phone: (360) 225-6888 | Toll-Free Phone: (877) 443-7683 | Main Fax: (800) 871-5007 | CS Fax: (877) 5-FAX-HDP

**[www.hamiltonnw.com](http://www.hamiltonnw.com)**