

ICC-ES Evaluation Report

ESR-3574

Reissued August 2024

This report also contains:

- LABC Supplement

Subject to renewal August 2026

- FBC Supplement

ICC-ES Evaluation Reports are not to be construed as representing aesthetics or any other attributes not specifically addressed, nor are they to be construed as an endorsement of the subject of the report or a recommendation for its use. There is no warranty by ICC Evaluation Service, LLC, express or implied, as to any finding or other matter in this report, or as to any product covered by the report.

Copyright © 2024 ICC Evaluation Service, LLC. All rights reserved.

<p>DIVISION: 03 00 00— CONCRETE</p> <p>Section: 03 16 00— Concrete Anchors</p> <p>DIVISION: 05 00 00— METALS</p> <p>Section: 05 05 19—Post- Installed Concrete Anchors</p>	<p>REPORT HOLDER: HILTI, INC.</p>	<p>EVALUATION SUBJECT: HILTI HIT-HY 100 ADHESIVE ANCHORING SYSTEM IN CRACKED AND UNCRACKED CONCRETE</p>	
--	---	---	---

1.0 EVALUATION SCOPE

Compliance with the following codes:

- 2021, 2018, and 2015 [International Building Code® \(IBC\)](#)
- 2021, 2018, and 2015 [International Residential Code® \(IRC\)](#)

For evaluation for compliance with codes adopted by the [Los Angeles Department of Building and Safety \(LADBS\)](#), see [ESR-3574 LABC and LARC Supplement](#).

Property evaluated:

- Structural

2.0 USES

Adhesive anchors installed using the Hilti HIT-HY 100 Adhesive Anchoring System are used to resist static, wind, or earthquake (Seismic Design Categories A through F) tension and shear loads in cracked and uncracked normal-weight and lightweight concrete having a specified compressive strength, f'_c , of 2,500 psi to 8,500 psi (17.2 MPa to 58.6 MPa).

The anchor system complies with anchors as described in Section 1901.3 of the IBC. The anchor systems may also be used where an engineered design is submitted in accordance with Section R301.1.3 of the IRC.

3.0 DESCRIPTION

3.1 General:

The Hilti HIT-HY 100 Adhesive Anchoring System is comprised of the following components:

- Hilti HIT-HY 100 adhesive packaged in foil packs.
- Adhesive mixing and dispensing equipment.
- Hole cleaning equipment.
- A steel anchoring element.

The Hilti HIT-HY 100 Adhesive Anchoring System may be used with continuously threaded rod, Hilti HIS-N and HIS-RN internally-threaded inserts or deformed reinforcing bar. The primary components of the Hilti Adhesive Anchoring System are shown in [Figure 3](#) of this report.

The manufacturer's printed installation instructions (MPII), as included with each adhesive unit package, are shown in [Figure 4](#) of this report.

3.2 Materials:

3.2.1 Hilti HIT-HY 100 Adhesive: Hilti HIT-HY 100 Adhesive is an injectable hybrid adhesive combining urethane methacrylate resin, hardener, cement and water. The resin and cement are kept separate from the hardener and water by means of a dual-cylinder foil pack attached to a manifold. The two components combine and react when dispensed through a static mixing nozzle attached to the manifold. Hilti HIT-HY 100 is available in 11.1-ounce (330 ml) and 16.9-ounce (500 ml) foil packs. The manifold attached to each foil pack is stamped with the adhesive expiration date. The shelf life, as indicated by the expiration date, applies to unopened foil packs that are stored in accordance with the manufacturer's printed installation instructions (MPII), as illustrated in [Figure 4](#) of this report.

3.2.2 Hole Cleaning Equipment:

3.2.2.1 Standard Hole Cleaning Equipment: Hole cleaning equipment comprised of steel wire brushes and air nozzles is illustrated in [Figure 4](#) of this report.

3.2.2.2 Hilti Safe-Set™ System: For the elements described in Section 3.2.4, the Hilti TE-CD and TE-YD hollow carbide drill bit with a carbide drilling head conforming to ANSI B212.15 must be used. When used in conjunction with a Hilti vacuum with a minimum value for the maximum volumetric flow rate of 129 CFM (61 ℓ/s), the Hilti TE-CD or TE-YD drill bit will remove the drilling dust, automatically cleaning the hole.

3.2.3 Dispensers: Hilti HIT-HY 100 must be dispensed with manual dispensers or electric dispensers provided by Hilti.

3.2.4 Anchor Elements:

3.2.4.1 Threaded Steel Rods: The threaded steel rods must be clean, continuously threaded rods (all-thread) in diameters as described in [Tables 6](#) and [11](#) of this report. Steel design information for common grades of threaded rod and associated nuts are provided in [Tables 2](#) and [4](#), and instructions for use are shown in [Figure 4](#). Carbon steel threaded rods must be furnished with a 0.0002-inch-thick (0.005 mm) zinc electroplate coating in accordance with ASTM B633 SC 1; or must be hot-dipped galvanized in accordance with ASTM A153, Class C or D. Threaded rods must be straight and free of indentations or other defects along their length. The ends may be stamped with identifying marks and the embedded end may be blunt cut or cut on the bias (chisel point).

3.2.4.2 Steel Reinforcing Bars: Steel reinforcing bars are deformed reinforcing bars as described in [Table 5](#) of this report. [Table 7](#), [Table 11](#) and [Table 15](#), along with the instructions for use shown in [Figure 4](#) of this report, summarize reinforcing bar size ranges. The embedded portions of reinforcing bars must be straight, and free of mill scale, rust, mud, oil, and other coatings that may impair the bond with the adhesive. Reinforcing bars must not be bent after installation except as set forth in ACI 318-19 26.6.3.2(b) or ACI 318-14 26.6.3.1(b), as applicable, with the additional condition that the bars must be bent cold, and heating of reinforcing bars to facilitate field bending is not permitted.

3.2.4.3 HIS-N and HIS-RN Inserts: Hilti HIS-N and HIS-RN inserts have a profile on the external surface and are internally threaded. Tensile properties for HIS-N and HIS-RN inserts are provided in [Table 3](#) of this report. The inserts are available in diameters as shown in [Table 18](#), and the instructions for use are shown in [Figure 4](#) of this report. HIS-N inserts are produced from carbon steel and furnished with a 0.0002-inch-thick (0.005 mm) zinc electroplated coating complying with ASTM B633 SC 1. The stainless steel HIS-RN inserts are fabricated from X5CrNiMo17122 K700 steel complying with DIN 17440 (EN 10088). Specifications for common bolt types that may be used in conjunction with HIS-N and HIS-RN inserts are provided in [Table 4](#). Bolt grade and material type (carbon, stainless) must be matched to the insert. Strength reduction factors, ϕ , corresponding to brittle steel elements must be used for HIS-N and HIS-RN inserts.

3.2.4.4 Ductility: In accordance with ACI 318-19 and ACI 318-14 2.3, in order for a steel element to be considered ductile, the tested elongation must be at least 14 percent and reduction of area must be at least 30 percent. Steel elements with a tested elongation of less than 14 percent or a reduction of area less than 30 percent, or both, are considered brittle. Values for various steel materials are provided in [Tables 2](#) through [5](#) of this report. Where values are nonconforming or unstated, the steel must be considered brittle.

3.3 Concrete:

Normal-weight and lightweight concrete must comply with Sections 1903 and 1905 of the IBC. The specified compressive strength of the concrete must be from 2,500 psi to 8,500 psi (17.2 MPa to 58.6 MPa).

4.0 DESIGN AND INSTALLATION

4.1 Strength Design:

4.1.1 General: The design strength of anchors under the 2021 IBC, as well as the 2021 IRC, must be determined in accordance with ACI 318-19 and this report. The design strength of anchors under the 2018 and 2015 IBC, as well as the 2018 and 2015 IRC, must be determined in accordance with ACI 318-14 and this report.

Design parameters are based on ACI 318-19 for use with the 2021 IBC and ACI 318-14 for use with the 2018 and 2015 IBC unless noted otherwise in Sections 4.1.1 through 4.1.11 of this report.

The strength design of anchors must comply with ACI 318-19 17.5.1.2 or ACI 318-14 17.3.1, as applicable, except as required in ACI 318-19 17.10 or ACI 318-14 17.2.3, as applicable.

Design parameters are provided in [Table 6](#) through [Table 20](#). Strength reduction factors, ϕ , as given in ACI 318-19 17.5.3 or ACI 318-14 17.3.3, as applicable, must be used for load combinations calculated in accordance with Section 1605.1 of the 2021 IBC (Section 1605.2 of the 2018 and 2015 IBC) or ACI 318-19 and ACI 318-14 5.3, as applicable.

4.1.2 Static Steel Strength in Tension: The nominal static steel strength of a single anchor in tension, N_{sa} , in accordance with ACI 318-19 17.6.1.2 or ACI 318-14 17.4.1.2, as applicable, and the associated strength reduction factors, ϕ , in accordance with ACI 318-19 17.5.3 or ACI 318-14 17.3.3, as applicable, are provided in the tables outlined in [Table 1](#) for the corresponding anchor steel.

4.1.3 Static Concrete Breakout Strength in Tension: The nominal static concrete breakout strength of a single anchor or group of anchors in tension, N_{cb} or N_{cbg} , must be calculated in accordance with ACI 318-19 17.6.2 or ACI 318-14 17.4.2, as applicable, with the following addition:

The basic concrete breakout strength of a single anchor in tension, N_b , must be calculated in accordance with ACI 318-19 17.6.2.2 or ACI 318-14 17.4.2.2, as applicable, using the values of $k_{c,cr}$ and $k_{c,uncr}$ as described in this report. Where analysis indicates no cracking in accordance with ACI 318-19 17.6.2.5 or ACI 318-14 17.4.2.6, as applicable, N_b must be calculated using $k_{c,uncr}$ and $\Psi_{c,N} = 1.0$. See [Table 1](#). For anchors in lightweight concrete, see ACI 318-19 17.2.4 or ACI 318-14 17.2.6, as applicable. The value of f'_c used for calculation must be limited to 8,000 psi (55 MPa) in accordance with ACI 318-19 17.3.1 or ACI 318-14 17.2.7, as applicable. Additional information for the determination of nominal bond strength in tension is given in Section 4.1.4 of this report.

4.1.4 Static Bond Strength in Tension: The nominal static bond strength of a single adhesive anchor or group of adhesive anchors in tension, N_a or N_{ag} , must be calculated in accordance with ACI 318-19 17.6.5 or ACI 318-14 17.4.5, as applicable. Bond strength values are a function of the concrete compressive strength, the concrete temperature range, and the installation conditions (dry or water-saturated concrete). The resulting characteristic bond strength shall be multiplied by the associated strength reduction factor ϕ_{bn} as follows:

CONCRETE TYPE	PERMISSIBLE INSTALLATION CONDITIONS	BOND STRENGTH	ASSOCIATED STRENGTH REDUCTION FACTOR
Uncracked	Dry	$\tau_{k,uncr}$	ϕ_d
	Water-saturated	$\tau_{k,uncr}$	ϕ_{ws}
Cracked	Dry	$\tau_{k,cr}$	ϕ_d
	Water-saturated	$\tau_{k,cr}$	ϕ_{ws}

[Figure 2](#) of this report presents a bond strength design selection flowchart. Strength reduction factors for determination of the bond strength are given in the tables outlined in [Table 1](#) of this report. Adjustments to the bond strength may also be taken for increased concrete compressive strength as noted in the footnotes to the corresponding tables.

4.1.5 Static Steel Strength in Shear: The nominal static steel strength of a single anchor in shear as governed by the steel, V_{sa} , in accordance with ACI 318-19 17.7.1.2 or ACI 318-14 17.5.1.2, as applicable, and strength reduction factor, ϕ , in accordance with ACI 318-19 17.5.3 or ACI 318-14 17.3.3, as applicable, are given in the tables outlined in [Table 1](#) of this report for the corresponding anchor steel.

4.1.6 Static Concrete Breakout Strength in Shear: The nominal static concrete breakout strength of a single anchor or group of anchors in shear, V_{cb} or V_{cbg} , must be calculated in accordance with ACI 318-19 17.7.2 or ACI 318-14 17.5.2, as applicable, based on information given in the tables outlined in [Table 1](#) of this report for the corresponding anchor steel.

The basic concrete breakout strength of a single anchor in shear, V_b , must be calculated in accordance with

ACI 318-19 17.7.2.2 or ACI 318-14 17.5.2.2, as applicable, using the values of d given in the tables outlined in [Table 1](#) for the corresponding anchor steel in lieu of d_a . In addition, h_{ef} must be substituted for l_e . In no case must l_e exceed $8d$. The value of f'_c must be limited to a maximum of 8,000 psi (55 MPa) in accordance with ACI 318-19 17.3.1 or ACI 318-14 17.2.7, as applicable.

4.1.7 Static Concrete Pryout Strength in Shear: The nominal static pryout strength of a single anchor or group of anchors in shear, V_{cp} or V_{cpg} , shall be calculated in accordance with ACI 318-19 17.7.3 or ACI 318-14 17.5.3, as applicable.

4.1.8 Interaction of Tensile and Shear Forces: For designs that include combined tension and shear, the interaction of tension and shear loads must be calculated in accordance with ACI 318-19 17.8 or ACI 318-14 17.6, as applicable.

4.1.9 Minimum Member Thickness, h_{min} , Anchor Spacing, s_{min} , and Edge Distance, c_{min} : In lieu of ACI 318-19 17.9.2 or ACI 318-14 17.7.1 and 17.7.3, as applicable, values of s_{min} and c_{min} described in this report must be observed for anchor design and installation. The minimum member thicknesses, h_{min} , described in this report must be observed for anchor design and installation. For adhesive anchors that will remain untorqued, ACI 318-19 17.9.3 or ACI 318-14 17.7.4, as applicable, applies.

REDUCED INSTALLATION TORQUE $T_{max,red}$ FOR EDGE DISTANCES $c_{ai} < (5 \times d_a)$		
EDGE DISTANCE, c_{ai}	MINIMUM ANCHOR SPACING, s_{ai}	MAXIMUM TORQUE, $T_{max,red}$
1.75 in. (45 mm) $\leq c_{ai} < 5 \times d_a$	$5 \times d_a \leq s_{ai} < 16$ in.	$0.3 \times T_{max}$
	$s_{ai} \geq 16$ in. (406 mm)	$0.5 \times T_{max}$

For the edge distance c_{ai} and anchor spacing s_{ai} , the maximum torque, T_{max} , shall comply with the following requirements:

4.1.10 Critical Edge Distance c_{ac} and $\psi_{cp,Na}$: The modification factor, $\psi_{cp,Na}$, must be determined in accordance with ACI 318-19 17.6.5.5 or ACI 318-14 17.4.5.5, as applicable, except as noted below:

For all cases where $c_{Na}/c_{ac} < 1.0$, $\psi_{cp,Na}$ determined from ACI 318-19 Eq. 17.6.5.5.1b or ACI 318-14 Eq. 17.4.5.5b, as applicable, need not be taken less than c_{Na}/c_{ac} . For all other cases, $\psi_{cp,Na}$ shall be taken as 1.0.

The critical edge distance, c_{ac} , must be calculated according to Eq. 17.6.5.5.1c for ACI 318-19 or Eq. 17.4.5.5c for ACI 318-14 in lieu of ACI 318-19 17.9.5 or ACI 318-14 17.7.6, as applicable.

$$c_{ac} = h_{ef} \cdot \left(\frac{\tau_{k,uncr}}{1160} \right)^{0.4} \cdot \left[3.1 - 0.7 \frac{h}{h_{ef}} \right]$$

(Eq. 17.6.5.5.1c for ACI 318-19 or Eq. 17.4.5.5c for ACI 318-14)

where

$\left[\frac{h}{h_{ef}} \right]$ need not be taken as larger than 2.4; and

$\tau_{k,uncr}$ is the characteristic bond strength in uncracked concrete, h is the member thickness, and h_{ef} is the embedment depth.

$\tau_{k,uncr}$ need not be taken as larger than:

$$\tau_{k,uncr} = \frac{k_{uncr} \sqrt{h_{ef} f'_c}}{\pi \cdot d_a} \tag{Eq. (4-1)}$$

4.1.11 Design Strength in Seismic Design Categories C, D, E, and F: In structures assigned to Seismic Design Category C, D, E or F under the IBC or IRC, anchors must be designed in accordance with ACI 318-19 17.10 or ACI 318-14 17.2.3, as applicable, except as described below:

Modifications to ACI 318-19 17.10 or ACI 318-14 17.2.3 shall be applied under Section 1905.1.8 of the IBC. The nominal steel shear strength, V_{sa} , must be adjusted by $\alpha_{V,seis}$ as given in the tables summarized in [Table 1](#) for the anchor element types included in this report. For tension, the nominal pullout strength $N_{p,cr}$ or bond strength $\tau_{k,cr}$ must be adjusted by $\alpha_{N,seis}$. See [Tables 9, 10, 13, 14, 17, and 20](#).

4.2 Installation:

Installation parameters are illustrated in [Figure 1](#) of this report. Installation must be in accordance with ACI 318-19 26.7.2 or ACI 318-14 17.8.1 and 17.8.2, as applicable. Anchor locations must comply with this report and the plans and specifications approved by the code official. Installation of the Hilti HIT-HY 100 Adhesive Anchor System must conform to the manufacturer’s printed installation instructions (MPII) included

in each unit package as provided in [Figure 4](#) of this report.

4.3 Special Inspection:

Periodic special inspection must be performed where required in accordance with Section 1705.1.1 and Table 1705.3 of the IBC and this report. The special inspector must be on the jobsite initially during anchor installation to verify anchor type, anchor dimensions, adhesive identification and expiration date, concrete type, concrete compressive strength, hole dimensions, hole cleaning procedures, anchor spacing, edge distances, concrete thickness, anchor embedment, tightening torque and adherence to the manufacturer's printed installation instructions.

The special inspector must verify the initial installations of each type and size of adhesive anchor by construction personnel on-site. Subsequent installations of the same anchor type and size by the same construction personnel shall be permitted to be performed in the absence of the special inspector. Any change in the anchor product being installed or the personnel performing the installation requires an initial inspection. For ongoing installations over an extended period, the special inspector shall make regular inspections to confirm correct handling and installation of the product.

Continuous special inspection of adhesive anchors installed in horizontal or upwardly inclined orientations to resist sustained tension loads shall be performed in accordance with ACI 318-19 26.13.3.2(e) and 26.7.1(j) or ACI 318-14 17.8.2.4, 26.7.1(h), and 26.13.3.2(c), as applicable.

Under the IBC, additional requirements as set forth in Sections 1705, 1706, or 1707 must be observed, where applicable.

5.0 CONDITIONS OF USE:

The Hilti HIT-HY 100 Adhesive Anchoring System described in this report complies with or is a suitable alternative to what is specified in those codes listed in Section 1.0 of this report, subject to the following conditions:

- 5.1 The Hilti HIT-HY 100 Adhesive Anchoring System must be installed in accordance with the manufacturer's printed installation instructions as included in the adhesive packaging and illustrated in [Figure 4](#) of this report.
- 5.2 Anchors must be installed in cracked and uncracked normal-weight and lightweight concrete having a specified compressive strength $f'_c = 2,500$ psi to 8,500 psi (17.2 MPa to 58.6 MPa).
- 5.3 The values of f'_c used for calculation purposes must not exceed 8,000 psi (55 MPa).
- 5.4 The concrete shall have attained its minimum design strength prior to installation of the adhesive anchors.
- 5.5 Anchors must be installed in concrete base materials in holes predrilled in accordance with the instructions provided in [Figure 4](#) of this report.
- 5.6 Loads applied to the anchors must be adjusted in accordance with Section 1605.1 of the 2021 IBC (Section 1605.2 of the 2018 and 2015 IBC) for strength design.
- 5.7 Hilti HIT-HY 100 adhesive anchors are recognized for use to resist short- and long-term loads, including wind and earthquake, subject to the conditions of this report.
- 5.8 In structures assigned to Seismic Design Category C, D, E or F under the IBC or IRC, anchor strength must be adjusted in accordance with Section 4.1.11 of this report.
- 5.9 Hilti HIT-HY 100 adhesive anchors are permitted to be installed in concrete that is cracked or that may be expected to crack during the service life of the anchor, subject to the conditions of this report.
- 5.10 Strength design values must be established in accordance with Section 4.1 of this report.
- 5.11 Minimum anchor spacing and edge distance as well as minimum member thickness must comply with the values given in this report.
- 5.12 Prior to anchor installation, calculations and details demonstrating compliance with this report shall be submitted to the code official. The calculations and details must be prepared by a registered design professional where required by the statutes of the jurisdiction in which the project is to be constructed.
- 5.13 Anchors are not permitted to support fire-resistive construction. Where not otherwise prohibited by the code, the Hilti HIT-HY 100 Adhesive Anchoring System is permitted for installation in fire-resistive construction provided that at least one of the following conditions is fulfilled:
 - Anchors are used to resist wind or seismic forces only.
 - Anchors that support gravity load-bearing structural elements are within a fire-resistive envelope or a fire-resistive membrane, are protected by approved fire-resistive materials, or have been evaluated for resistance to fire exposure in accordance with recognized standards.
 - Anchors are used to support nonstructural elements.

- 5.14** Since an ICC-ES acceptance criteria for evaluating data to determine the performance of adhesive anchors subjected to fatigue or shock loading is unavailable at this time, the use of these anchors under such conditions is beyond the scope of this report.
- 5.15** Use of zinc-plated carbon steel threaded rods, zinc-plated HIS-N inserts, or steel reinforcing bars is limited to dry, interior locations.
- 5.16** Use of hot-dipped galvanized carbon steel or stainless steel rods, or stainless steel HIS-RN inserts, is permitted for exterior exposure or damp environments.
- 5.17** Steel anchoring materials in contact with preservative-treated and fire-retardant treated wood must be of zinc-coated carbon steel or stainless steel. The minimum coating weights for zinc-coated steel must comply with ASTM A153.
- 5.18** Periodic special inspection must be provided in accordance with Section 4.3 of this report. Continuous special inspection for anchors installed in horizontal or upwardly inclined orientations to resist sustained tension loads must be provided in accordance with Section 4.3 of this report.
- 5.19** Installation of anchors in horizontal or upwardly inclined orientations to resist sustained tension loads shall be performed by personnel certified by an applicable certification program in accordance with ACI 318-19 26.7.2(e) or ACI 318-14 17.8.2.2 or 17.8.2.3, as applicable.
- 5.20** Hilti HIT-HY 100 adhesive anchors may be used to resist tension and shear forces in floor, wall, and overhead installations only if installation is into concrete with a temperature between 14°F and 104°F (-10°C and 40°C) for threaded rods, rebar, and Hilti HIS-(R)N inserts. Overhead installations for hole diameters larger than $\frac{7}{16}$ -inch or 10mm require the use of piston plugs (HIT-SZ) during injection to the back of the hole. $\frac{7}{16}$ -inch and 10mm diameter holes may be injected directly to the back of the hole with the use of extension tubing on the end of the nozzle. The anchor or post-installed reinforcing bars must be supported until fully cured (i.e., with Hilti HIT-OHW wedges, or other suitable means). Where temporary restraint devices are used, their use shall not result in impairment of the anchor shear resistance. Installations in concrete temperatures below 41°F require the adhesive to be conditioned to a minimum temperature of 41°F.
- 5.21** Anchors when installed at temperatures below 40°F shall not be used for applications where the concrete temperature can rise from 40°F (or less) to 80°F (or higher) within a 12-hour period. Such applications may include but are not limited to anchorage of building facade systems and other applications subject to direct sun exposure. See MPII in [Figure 4](#) for additional temperature requirements.
- 5.22** Hilti HIT-HY 100 adhesive is manufactured by Hilti GmbH, Kaufering, Germany, under a quality control program with inspections by ICC-ES.
- 5.23** Hilti HIS-N and HIS-RN inserts are manufactured by Hilti (China) Ltd., Guangdong, China, under a quality-control program with inspections by ICC-ES.

6.0 EVIDENCE SUBMITTED



Data in accordance with the [ICC-ES Acceptance Criteria for Post-installed Adhesive Anchors in Concrete Elements \(AC308\)](#), dated October 2022 (editorially revised February 2021), which incorporates requirements in ACI 355.4 (-19 and -11) including but not limited to tests under freeze-thaw conditions (Table 3.2, Test series 6).

7.0 IDENTIFICATION

- 7.1** The ICC-ES mark of conformity, electronic labeling, or the evaluation report number (ICC-ES ESR-3574) along with the name, registered trademark, or registered logo of the report holder must be included in the product label.
- 7.2** In addition, the adhesives are identified by packaging labeled with the manufacturer's name (Hilti, Inc.) and address, anchor name and anchor size.
- 7.3** In addition, the HIS-N and HIS-RN inserts are identified by packaging labeled with the manufacturer's name (Hilti, Inc.) and address and anchor name.
- 7.4** Threaded rods, nuts, washers, bolts, cap screws, and deformed reinforcing bars are standard elements and must conform to applicable national or international specifications as set forth in [Tables 2](#) through [5](#).
- 7.5** The report holder's contact information is the following:

HILTI, INC.
7250 DALLAS PARKWAY, SUITE 1000
PLANO, TEXAS 75024
(800) 879-8000
www.hilti.com

TABLE 1—DESIGN TABLE INDEX

Design Table		Fractional		Metric			
		Table	Page	Table	Page		
Standard Threaded Rod 	Steel Strength - N_{sa} , V_{sa}	6	10	11	15		
	Concrete Breakout - N_{cb} , N_{cbg} , V_{cb} , V_{cbg} , V_{cp} , V_{cpg}	8	12	12	16		
	Bond Strength - N_a , N_{ag}	9	13	13	17		
Hilti HIS-N and HIS-RN Internally Threaded Insert 	Steel Strength - N_{sa} , V_{sa}	18	21	18	21		
	Concrete Breakout - N_{cb} , N_{cbg} , V_{cb} , V_{cbg} , V_{cp} , V_{cpg}	19	22	19	22		
	Bond Strength - N_a , N_{ag}	20	23	20	23		
Design Table		Fractional		EU Metric		Canadian	
		Table	Page	Table	Page	Table	Page
Steel Reinforcing Bars 	Steel Strength - N_{sa} , V_{sa}	7	11	11	15	15	19
	Concrete Breakout - N_{cb} , N_{cbg} , V_{cb} , V_{cbg} , V_{cp} , V_{cpg}	8	12	12	16	16	19
	Bond Strength - N_a , N_{ag}	10	14	14	18	17	20

DEFORMED REINFORCEMENT

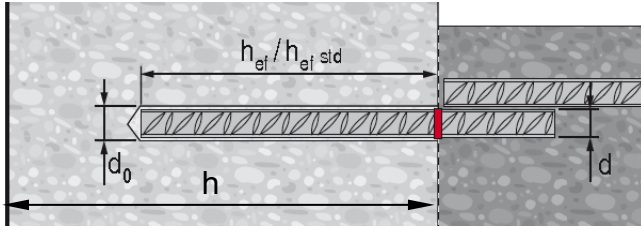

US REBAR

d	$\varnothing d_0$ [inch]	$h_{ef\ std}$ [inch]	h_{ef} [inch]
#3	1/2	3 3/8	2 3/8...7 1/2
#4	5/8	4 1/2	2 3/4...10
#5	3/4	5 5/8	3 1/8...12 1/2
#6	7/8	6 3/4	3 1/2...15
#7	1	7 7/8	3 1/2...17 1/2
#8	1 1/8	9	4...20
#9	1 3/8	10 1/8	4 1/2...22 1/2
#10	1 1/2	11 1/4	5...25

CANADIAN REBAR

d	$\varnothing d_0$ [inch]	$h_{ef\ std}$ [mm]	h_{ef} [mm]
10 M	3/16	115	70...226
15 M	3/4	145	80...320
20 M	1	200	90...390
25 M	1 1/4	230	101...504
30 M	1 1/2	260	120...598

EUROPEAN REBAR

$\varnothing d$ [mm]	$\varnothing d_0$ [mm]	$h_{ef\ std}$ [mm]	h_{ef} [mm]
8	12	80	60...160
10	14	90	60...200
12	16	110	70...240
14	18	125	75...280
16	20	125	80...320
20	25	170	90...400
25	32	210	100...500
28	35	270	112...560
32	40	300	128...640

THREADED ROD

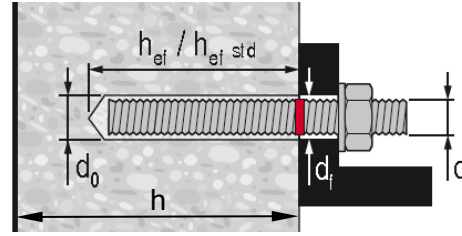

FRACTIONAL THREADED ROD

$\varnothing d$ [inch]	$\varnothing d_0$ [inch]	$h_{ef\ std}$ [inch]	h_{ef} [inch]	T_{max} [ft-lb]	T_{max} [Nm]
3/8	7/16	3 3/8	2 3/8...7 1/2	15	20
1/2	9/16	4 1/2	2 3/4...10	30	41
5/8	3/4	5 5/8	3 1/8...12 1/2	60	81
3/4	7/8	6 3/4	3 1/2...15	100	136
7/8	1	7 7/8	3 1/2...17 1/2	125	169
1	1 1/8	9	4...20	150	203
1 1/4	1 3/8	11 1/4	5...25	200	271

METRIC THREADED ROD

$\varnothing d$ [mm]	$\varnothing d_0$ [mm]	$h_{ef\ std}$ [mm]	h_{ef} [mm]	T_{max} [Nm]
M8	10	80	60...160	10
M10	12	90	60...200	20
M12	14	110	70...240	40
M16	18	125	80...320	80
M20	22	170	90...400	150
M24	28	210	96...480	200
M27	30	240	108...540	270
M30	35	270	120...600	300

HILTI HIS-N AND HIS-RN THREADED INSERTS

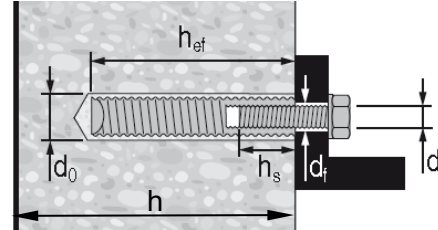

FRACTIONAL HILTI HIS-N AND HIS-RN THREADED INSERTS

$\varnothing d$ [inch]	$\varnothing d_0$ [inch]	h_{ef} [inch]	$\varnothing d_1$ [inch]	h_s [inch]	T_{max} [ft-lb]	T_{max} [Nm]
3/8	1 1/16	4 3/8	7/16	3/8...1 5/16	15	20
1/2	7/8	5	9/16	1/2...1 3/16	30	41
5/8	1 1/8	6 3/4	1 1/16	5/8...1 1/2	60	81
3/4	1 1/4	8 1/8	1 3/16	3/4...1 7/8	100	136

METRIC HILTI HIS-N AND HIS-RN THREADED INSERTS

$\varnothing d$ [mm]	$\varnothing d_0$ [mm]	h_{ef} [mm]	$\varnothing d_1$ [mm]	h_s [mm]	T_{max} [Nm]
M8	14	90	9	8...20	10
M10	18	110	12	10...25	20
M12	22	125	14	12...30	40
M16	28	170	18	16...40	80
M20	32	205	22	20...50	150

FIGURE 1—INSTALLATION PARAMETERS

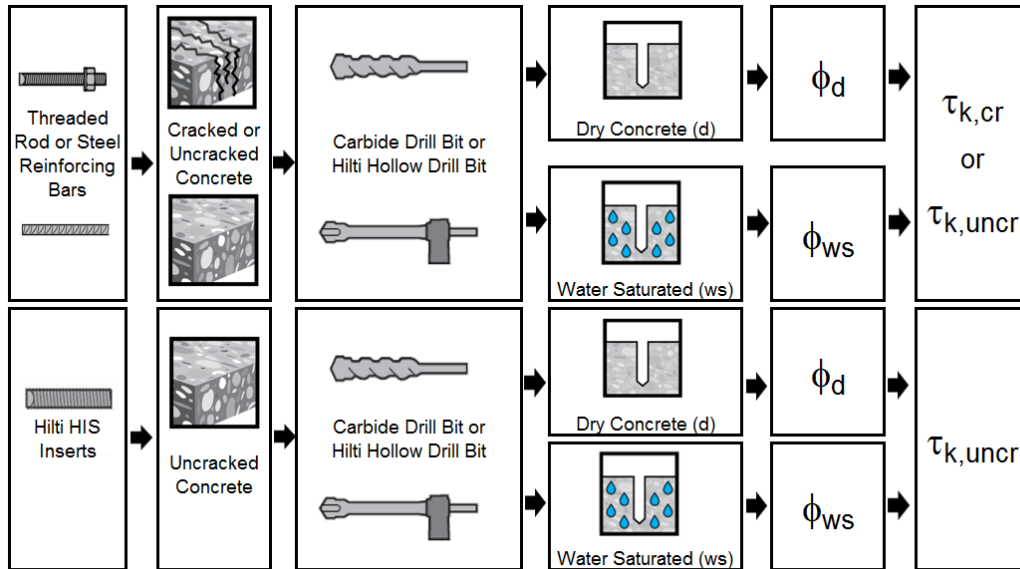

FIGURE 2—FLOWCHART FOR ESTABLISHMENT OF DESIGN BOND STRENGTH

TABLE 2—SPECIFICATIONS AND PHYSICAL PROPERTIES OF COMMON CARBON AND STAINLESS STEEL THREADED ROD MATERIALS¹

THREADED ROD SPECIFICATION			Minimum specified ultimate strength, f_{uta}	Minimum specified yield strength 0.2 percent offset, f_{ya}	f_{uta}/f_{ya}	Elongation, min. percent ⁸	Reduction of Area, min. percent	Specification for nuts ⁹
CARBON STEEL	ASTM A193 ² Grade B7	psi (MPa)	125,000 (862)	105,000 (724)	1.19	16	50	ASTM A563 Grade DH
	ASTM F568M ³ Class 5.8	psi (MPa)	72,500 (500)	58,000 (400)	1.25	10	35	ASTM A563 Grade DH ¹⁰ DIN 934 (8-A2K)
	ASTM F1554, Grade 36 ⁷	psi (MPa)	58,000 (400)	36,000 (248)	1.61	23	40	ASTM A194 or ASTM A563
	ASTM F1554, Grade 55 ⁷	psi (MPa)	75,000 (517)	55,000 (379)	1.36	21	30	ASTM A194 or ASTM A563
	ASTM F1554, Grade 105 ⁷	psi (MPa)	125,000 (862)	105,000 (724)	1.19	15	45	ASTM A194 or ASTM A563
	ISO 898-1 ⁴ Class 5.8	MPa (psi)	500 (72,500)	400 (58,000)	1.25	22	-	DIN 934 Grade 6
	ISO 898-1 ⁴ Class 8.8	MPa (psi)	800 (116,000)	640 (92,800)	1.25	12	52	DIN 934 Grade 8
STAINLESS STEEL	ASTM F593 ⁵ CW1 (316)	psi (MPa)	100,000 (689)	65,000 (448)	1.54	20	-	ASTM F594
	ASTM F593 ⁵ CW2 (316)	psi (MPa)	85,000 (586)	45,000 (310)	1.89	25	-	ASTM F594
	ASTM A193 Grade 8(M), Class 1 ² - 1 1/4-in.	psi (MPa)	75,000 (517)	30,000 (207)	2.50	30	50	ASTM F594
	ISO 3506-1 ⁶ A4-70	MPa (psi)	700 (101,500)	450 (65,250)	1.56	40	-	ISO 4032
	ISO 3506-1 ⁶ A4-50	MPa (psi)	500 (72,500)	210 (30,450)	2.38	40	-	ISO 4032

¹ Hilti HIT-HY 100 adhesive may be used in conjunction with all grades of continuously threaded carbon or stainless steel rod (all-thread) that comply with the code reference standards and that have thread characteristics comparable with ANSI B1.1 UNC Coarse Thread Series or ANSI B1.13M M Profile Metric Thread Series. Values for threaded rod types and associated nuts supplied by Hilti are provided here.

² Standard Specification for Alloy-Steel and Stainless Steel Bolting Materials for High-Temperature Service

³ Standard Specification for Carbon and Alloy Steel Externally Threaded Metric Fasteners

⁴ Mechanical properties of fasteners made of carbon steel and alloy steel – Part 1: Bolts, screws and studs

⁵ Standard Steel Specification for Stainless Steel Bolts, Hex Cap Screws, and Studs

⁶ Mechanical properties of corrosion-resistant stainless steel fasteners – Part 1: Bolts, screws and studs

⁷ Standard Specification for Anchor Bolts, Steel, 36, 55, and 105-ksi Yield Strength

⁸ Based on 2-in. (50 mm) gauge length except for A193, which are based on a gauge length of 4d and ISO 898, which is based on 5d.

⁹ Nuts of other grades and styles having specified proof load stresses greater than the specified grade and style are also suitable. Nuts must have specified proof load stresses equal to or greater than the minimum tensile strength of the specified threaded rod.

¹⁰ Nuts for fractional rods

TABLE 3—SPECIFICATIONS AND PHYSICAL PROPERTIES OF FRACTIONAL AND METRIC HIS-N AND HIS-RN INSERTS



HILTI HIS-N AND HIS-RN INSERTS		Minimum specified ultimate strength, f_{uta}	Minimum specified yield strength, f_{ya}
 Carbon Steel DIN EN 10277-3 11SMnPb30+c or DIN 1561 9SMnPb28K 3/8-in. and M8 to M10	psi	71,050	59,450
	(MPa)	(490)	(410)
Carbon Steel DIN EN 10277-3 11SMnPb30+c or DIN 1561 9SMnPb28K 1/2 to 3/4-in. and M12 to M20	psi	66,700	54,375
	(MPa)	(460)	(375)
Stainless Steel EN 10088-3 X5CrNiMo 17-12-2	psi	101,500	50,750
	(MPa)	(700)	(350)

TABLE 4—SPECIFICATIONS AND PHYSICAL PROPERTIES OF COMMON BOLTS, CAP SCREWS AND STUDS FOR USE WITH HIS-N AND HIS-RN INSERTS^{1,2}

BOLT, CAP SCREW OR STUD SPECIFICATION		Minimum specified ultimate strength f_{uta}	Minimum specified yield strength 0.2 percent offset f_{ya}	f_{uta}/f_{ya}	Elongation, min.	Reduction of Area, min.	Specification for nuts ⁶
 SAE J429 ³ Grade 5	psi	120,000	92,000	1.30	14	35	SAE J995
	(MPa)	(828)	(634)				
ASTM A325 ⁴ 1/2 to 1-in.	psi	120,000	92,000	1.30	14	35	A563 C, C3, D, DH, DH3 Heavy Hex
	(MPa)	(828)	(634)				
ASTM A193 ⁵ Grade B8M (AISI 316) for use with HIS-RN	psi	110,000	95,000	1.16	15	45	ASTM F594 ⁷
	(MPa)	(759)	(655)				
ASTM A193 ⁵ Grade B8T (AISI 321) for use with HIS-RN	psi	125,000	100,000	1.25	12	35	ASTM F594 ⁷
	(MPa)	(862)	(690)				

¹ Minimum Grade 5 bolts, cap screws or studs must be used with carbon steel HIS-N inserts.

² Only stainless steel bolts, cap screws or studs must be used with HIS-RN inserts.

³ Mechanical and Material Requirements for Externally Threaded Fasteners

⁴ Standard Specification for Structural Bolts, Steel, Heat Treated, 120/105 ksi Minimum Tensile Strength

⁵ Standard Specification for Alloy-Steel and Stainless Steel Bolting Materials for High-Temperature Service

⁶ Nuts must have specified minimum proof load stress equal to or greater than the specified minimum full-size tensile strength of the specified stud.

⁷ Nuts for stainless steel studs must be of the same alloy group as the specified bolt, cap screw, or stud.

TABLE 5—SPECIFICATIONS AND PHYSICAL PROPERTIES OF COMMON STEEL REINFORCING BARS

REINFORCING BAR SPECIFICATION		Minimum specified ultimate strength, f_{uta}	Minimum specified yield strength, f_{ya}
 ASTM A615 ¹ Gr. 60	psi	80,000	60,000
	(MPa)	(550)	(414)
ASTM A615 ¹ Gr. 40	psi	60,000	40,000
	(MPa)	(414)	(276)
ASTM A706 ² Gr. 60	psi	80,000	60,000
	(MPa)	(550)	(414)
DIN 488 ³ BSt 500	MPa	550	500
	(psi)	(79,750)	(72,500)
CAN/CSA-G30.18 ⁴ Gr. 400	MPa	540	400
	(psi)	(78,300)	(58,000)

¹ Standard Specification for Deformed and Plain Carbon Steel Bars for Concrete Reinforcement

² Standard Specification for Low Alloy Steel Deformed and Plain Bars for Concrete Reinforcement

³ Reinforcing steel; reinforcing steel bars; dimensions and masses

⁴ Billet-Steel Bars for Concrete Reinforcement



Fractional Threaded Rod

Steel Strength

TABLE 6—STEEL DESIGN INFORMATION FOR FRACTIONAL THREADED ROD

DESIGN INFORMATION		Symbol	Units	Nominal rod diameter (in.) ¹						
				3/8	1/2	5/8	3/4	7/8	1	1 1/4
Rod O.D.		<i>d</i>	in. (mm)	0.375 (9.5)	0.5 (12.7)	0.625 (15.9)	0.75 (19.1)	0.875 (22.2)	1 (25.4)	1.25 (31.8)
Rod effective cross-sectional area		<i>A_{se}</i>	in. ² (mm ²)	0.0775 (50)	0.1419 (92)	0.2260 (146)	0.3345 (216)	0.4617 (298)	0.6057 (391)	0.9691 (625)
ISO 898-1 Class 5.8	Nominal strength as governed by steel strength	<i>N_{sa}</i>	lb (kN)	5,620 (25.0)	10,290 (45.8)	16,385 (72.9)	24,250 (107.9)	33,470 (148.9)	43,910 (195.3)	70,260 (312.5)
		<i>V_{sa}</i>	lb (kN)	3,370 (15.0)	6,175 (27.5)	9,830 (43.7)	14,550 (64.7)	20,085 (89.3)	26,345 (117.2)	42,155 (187.5)
	Reduction for seismic shear	<i>α_{v,seis}</i>	-	0.70						
	Strength reduction factor for tension ²	<i>φ</i>	-	0.65						
	Strength reduction factor for shear ²	<i>φ</i>	-	0.60						
ASTM A193 B7	Nominal strength as governed by steel strength	<i>N_{sa}</i>	lb (kN)	9,685 (43.1)	17,735 (78.9)	28,250 (125.7)	41,810 (186.0)	57,710 (256.7)	75,710 (336.8)	121,135 (538.8)
		<i>V_{sa}</i>	lb (kN)	5,810 (25.9)	10,640 (47.3)	16,950 (75.4)	25,085 (111.6)	34,625 (154.0)	45,425 (202.1)	72,680 (323.3)
	Reduction for seismic shear	<i>α_{v,seis}</i>	-	0.70						
	Strength reduction factor for tension ²	<i>φ</i>	-	0.75						
	Strength reduction factor for shear ²	<i>φ</i>	-	0.65						
ASTM F1554 Gr. 36	Nominal strength as governed by steel strength	<i>N_{sa}</i>	lb (kN)	- (-)	8,230 (36.6)	13,110 (58.3)	19,400 (86.3)	26,780 (119.1)	35,130 (156.3)	56,210 (250.0)
		<i>V_{sa}</i>	lb (kN)	- (-)	4,940 (22.0)	7,865 (35.0)	11,640 (51.8)	16,070 (71.5)	21,080 (93.8)	33,725 (150.0)
	Reduction factor, seismic shear	<i>α_{v,seis}</i>	-	0.60						
	Strength reduction factor <i>φ</i> for tension ²	<i>φ</i>	-	0.75						
	Strength reduction factor <i>φ</i> for shear ²	<i>φ</i>	-	0.65						
ASTM F1554 Gr. 55	Nominal strength as governed by steel strength	<i>N_{sa}</i>	lb (kN)	- (-)	10,645 (47.4)	16,950 (75.4)	25,090 (111.6)	34,630 (154.0)	45,430 (202.1)	72,685 (323.3)
		<i>V_{sa}</i>	lb (kN)	- (-)	6,385 (28.4)	10,170 (45.2)	15,055 (67.0)	20,780 (92.4)	27,260 (121.3)	43,610 (194.0)
	Reduction factor, seismic shear	<i>α_{v,seis}</i>	-	0.70						
	Strength reduction factor <i>φ</i> for tension ²	<i>φ</i>	-	0.75						
	Strength reduction factor <i>φ</i> for shear ²	<i>φ</i>	-	0.65						
ASTM F1554 Gr. 105	Nominal strength as governed by steel strength	<i>N_{sa}</i>	lb (kN)	- (-)	17,740 (78.9)	28,250 (125.7)	41,815 (186.0)	57,715 (256.7)	75,715 (336.8)	121,135 (538.8)
		<i>V_{sa}</i>	lb (kN)	- (-)	10,645 (47.4)	16,950 (75.4)	25,090 (111.6)	34,630 (154.0)	45,430 (202.1)	72,680 (323.3)
	Reduction factor, seismic shear	<i>α_{v,seis}</i>	-	0.70						
	Strength reduction factor <i>φ</i> for tension ²	<i>φ</i>	-	0.75						
	Strength reduction factor <i>φ</i> for shear ²	<i>φ</i>	-	0.65						
ASTM F593, CW Stainless	Nominal strength as governed by steel strength	<i>N_{sa}</i>	lb (kN)	7,750 (34.5)	14,190 (63.1)	22,600 (100.5)	28,430 (126.5)	39,245 (174.6)	51,485 (229.0)	- (-)
		<i>V_{sa}</i>	lb (kN)	4,650 (20.7)	8,515 (37.9)	13,560 (60.3)	17,060 (75.9)	23,545 (104.7)	30,890 (137.4)	- (-)
	Reduction factor, seismic shear	<i>α_{v,seis}</i>	-	0.70						
	Strength reduction factor for tension ²	<i>φ</i>	-	0.65						
	Strength reduction factor for shear ²	<i>φ</i>	-	0.60						
ASTM A193, Gr. 8(M), Class 1 Stainless	Nominal strength as governed by steel strength	<i>N_{sa}</i>	lb (kN)	-	-	-	-	-	-	55,240 (245.7)
		<i>V_{sa}</i>	lb (kN)	-	-	-	-	-	-	33,145 (147.4)
	Reduction factor, seismic shear	<i>α_{v,seis}</i>	-	0.6						
	Strength reduction factor <i>φ</i> for tension ²	<i>φ</i>	-	0.75						
	Strength reduction factor <i>φ</i> for shear ²	<i>φ</i>	-	0.65						

For **SI**: 1 inch = 25.4 mm, 1 lbf = 4.448 N. For **pound-inch** units: 1 mm = 0.03937 inches, 1 N = 0.2248 lbf

¹ Values provided for common rod material types are based on specified strengths and calculated in accordance with ACI 318-19 Eq. (17.6.1.2) and Eq. (17.7.1.2b) or ACI 318-14 Eq. (17.4.1.2) and Eq (17.5.1.2b), as applicable. Nuts and washers must be appropriate for the rod.

² The strength reduction factor applies when the load combinations from the IBC or ACI 318 are used, and the requirements of ACI 318-19 17.5.3 or ACI 318-14 17.3.3, as applicable, are met.

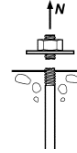

Fractional Reinforcing Bars

Steel Strength

TABLE 7—STEEL DESIGN INFORMATION FOR FRACTIONAL REINFORCING BARS

DESIGN INFORMATION		Symbol	Units	Nominal Reinforcing bar size (Rebar) ¹							
				#3	#4	#5	#6	#7	#8	#9	#10
Nominal bar diameter		d	in. (mm)	³ / ₈ (9.5)	¹ / ₂ (12.7)	⁵ / ₈ (15.9)	³ / ₄ (19.1)	⁷ / ₈ (22.2)	1 (25.4)	1.128 (28.7)	1.270 (32.3)
Bar effective cross-sectional area		A_{se}	in. ² (mm ²)	0.11 (71)	0.2 (129)	0.31 (199)	0.44 (284)	0.6 (387)	0.79 (510)	1.0 (645)	1.27 (819)
ASTM A615 Grade 40	Nominal strength as governed by steel strength	N_{sa}	lb (kN)	6,600 (29.4)	12,000 (53.4)	18,600 (82.7)	26,400 (117.4)	36,000 (160.1)	47,400 (210.9)	60,000 (266.9)	76,200 (339.0)
		V_{sa}	lb (kN)	3,960 (17.6)	7,200 (32.0)	11,160 (49.6)	15,840 (70.5)	21,600 (96.1)	28,440 (126.5)	36,000 (160.1)	45,720 (203.4)
	Reduction for seismic shear	$\alpha_{v,seis}$	-	0.70							
	Strength reduction factor ϕ for tension ²	ϕ	-	0.65							
	Strength reduction factor ϕ for shear ²	ϕ	-	0.60							
ASTM A615 Grade 60	Nominal strength as governed by steel strength	N_{sa}	lb (kN)	8,800 (39.1)	16,000 (71.2)	24,800 (110.3)	35,200 (156.6)	48,000 (213.5)	63,200 (281.1)	80,000 (355.9)	101,600 (451.9)
		V_{sa}	lb (kN)	5,280 (23.5)	9,600 (42.7)	14,880 (66.2)	21,120 (93.9)	28,800 (128.1)	37,920 (168.7)	48,000 (213.5)	60,960 (271.2)
	Reduction for seismic shear	$\alpha_{v,seis}$	-	0.70							
	Strength reduction factor ϕ for tension ²	ϕ	-	0.65							
	Strength reduction factor ϕ for shear ²	ϕ	-	0.60							
ASTM A706 Grade 60	Nominal strength as governed by steel strength	N_{sa}	lb (kN)	8,800 (39.1)	16,000 (71.2)	24,800 (110.3)	35,200 (156.6)	48,000 (213.5)	63,200 (281.1)	80,000 (355.9)	101,600 (452.0)
		V_{sa}	lb (kN)	5,280 (23.5)	9,600 (42.7)	14,880 (66.2)	21,120 (94.0)	28,800 (128.1)	37,920 (168.7)	48,000 (213.5)	60,960 (271.2)
	Reduction for seismic shear	$\alpha_{v,seis}$	-	0.70							
	Strength reduction factor ϕ for tension ²	ϕ	-	0.75							
	Strength reduction factor ϕ for shear ²	ϕ	-	0.65							

For **SI**: 1 inch = 25.4 mm, 1 lbf = 4.448 N. For **pound-inch** units: 1 mm = 0.03937 inches, 1 N = 0.2248 lbf

¹ Values provided for common rod material types are based on specified strengths and calculated in accordance with ACI 318-19 Eq. (17.6.1.2) and Eq. (17.7.1.2b) or ACI 318-14 Eq. (17.4.1.2) and Eq (17.5.1.2b), as applicable. Nuts and washers must be appropriate for the rod.

² The strength reduction factor applies when the load combinations from the IBC or ACI 318 are used, and the requirements of ACI 318-19 17.5.3 or ACI 318-14 17.3.3, as applicable, are met.

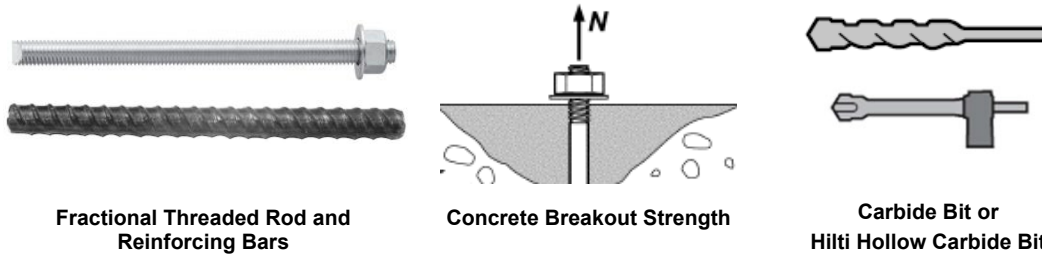

TABLE 8—CONCRETE BREAKOUT DESIGN INFORMATION FOR FRACTIONAL THREADED ROD AND REINFORCING BARS IN HOLES DRILLED WITH A HAMMER DRILL AND CARBIDE BIT OR HILTI HOLLOW CARBIDE BIT ¹

DESIGN INFORMATION	Symbol	Units	Nominal rod diameter (in.) / Reinforcing bar size							
			³ / ₈ or #3	¹ / ₂ or #4	⁵ / ₈ or #5	³ / ₄ or #6	⁷ / ₈ or #7	1 or #8	#9	1 ¹ / ₄ or #10
Effectiveness factor for uncracked concrete	$k_{c,uncr}$	in-lb (SI)	24 (10)							
Effectiveness factor for cracked concrete	$k_{c,cr}$	in-lb (SI)	17 (7)							
Minimum Embedment	$h_{ef,min}$	in. (mm)	2 ³ / ₈ (60)	2 ³ / ₄ (70)	3 ¹ / ₈ (79)	3 ¹ / ₂ (89)	3 ¹ / ₂ (89)	4 (102)	4 ¹ / ₂ (114)	5 (127)
Maximum Embedment	$h_{ef,max}$	in. (mm)	7 ¹ / ₂ (191)	10 (254)	12 ¹ / ₂ (318)	15 (381)	17 ¹ / ₂ (445)	20 (508)	22 ¹ / ₂ (572)	25 (635)
Min. anchor spacing ⁴	s_{min}	in. (mm)	1 ⁷ / ₈ (48)	2 ¹ / ₂ (64)	3 ¹ / ₈ (79)	3 ³ / ₄ (95)	4 ³ / ₈ (111)	5 (127)	5 ⁵ / ₈ (143)	6 ¹ / ₄ (159)
Min. edge distance ⁴	c_{min}	-	5d; or see Section 4.1.9 of this report for design with reduced minimum edge distances							
Minimum concrete thickness	h_{min}	in. (mm)	$h_{ef} + 1\frac{1}{4}$ ($h_{ef} + 30$)			$h_{ef} + 2d_o^{(3)}$				
Critical edge distance – splitting (for uncracked concrete)	c_{ac}	-	See Section 4.1.10 of this report.							
Strength reduction factor for tension, concrete failure modes, Condition B (supplemental reinforcement not present) ²	ϕ	-	0.65							
Strength reduction factor for shear, concrete failure modes, Condition B (supplemental reinforcement not present) ²	ϕ	-	0.70							

For SI: 1 inch ≡ 25.4 mm, 1 lbf = 4.448 N, 1 psi = 0.006897 MPa.
 For pound-inch units: 1 mm = 0.03937 inches, 1 N = 0.2248 lbf, 1 MPa = 145.0 psi.

¹ For additional setting information, see installation instructions in [Figure 4](#).

² The strength reduction factor applies when the load combinations from the IBC or ACI 318 are used, and the requirements of ACI 318-19 17.5.3 or ACI 318-14 17.3.3, as applicable, are met.

³ d_o = hole diameter.

⁴ For installations with 1³/₄-inch edge distance, refer to Section 4.1.9 for spacing and maximum torque requirements.

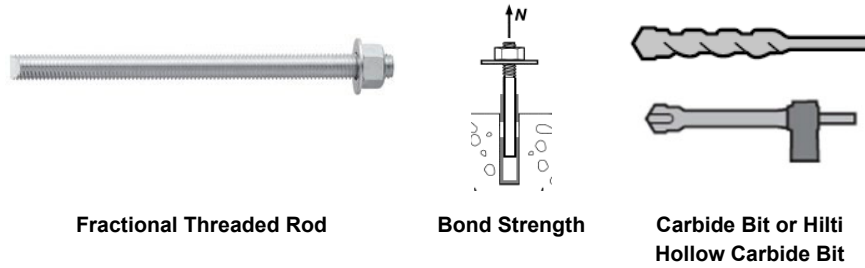

TABLE 9—BOND STRENGTH DESIGN INFORMATION FOR FRACTIONAL THREADED ROD IN HOLES DRILLED WITH A HAMMER DRILL AND CARBIDE BIT OR HILTI HOLLOW CARBIDE BIT^{1,3}

DESIGN INFORMATION		Symbol	Units	Nominal rod diameter (in.)							
				3/8	1/2	5/8	3/4	7/8	1	1 1/4	
Minimum anchor embedment depth		$h_{ef,min}$	in. (mm)	2 3/8 (60)	2 3/4 (70)	3 1/8 (80)	3 1/2 (89)	3 1/2 (89)	4 (102)	5 (127)	
Maximum anchor embedment depth		$h_{ef,max}$	in. (mm)	7 1/2 (191)	10 (254)	12 1/2 (318)	15 (381)	17 1/2 (445)	20 (508)	25 (635)	
Temperature Range ²	A	Characteristic bond strength in uncracked concrete	$\tau_{k,uncr}$	psi (MPa)	1,490 (10.3)	1,490 (10.3)	1,490 (10.3)	1,490 (10.3)	1,390 (9.6)	1,270 (8.9)	1,030 (7.1)
		Characteristic bond strength in cracked concrete	$\tau_{k,cr}$	psi (MPa)	615 (4.2)	670 (4.6)	725 (5.0)	775 (5.3)	780 (5.4)	790 (5.4)	- -
	B	Characteristic bond strength in uncracked concrete	$\tau_{k,uncr}$	psi (MPa)	1,450 (10.0)	1,450 (10.0)	1,450 (10.0)	1,385 (9.5)	1,275 (8.8)	1,170 (8.1)	950 (6.5)
		Characteristic bond strength in cracked concrete	$\tau_{k,cr}$	psi (MPa)	565 (3.9)	620 (4.3)	665 (4.6)	715 (4.9)	720 (5.0)	725 (5.0)	- -
	C	Characteristic bond strength in uncracked concrete	$\tau_{k,uncr}$	psi (MPa)	1,250 (8.6)	1,250 (8.6)	1,165 (8.0)	1,080 (7.4)	995 (6.9)	910 (6.3)	740 (5.1)
		Characteristic bond strength in cracked concrete	$\tau_{k,cr}$	psi (MPa)	440 (3.0)	480 (3.3)	520 (3.5)	555 (3.8)	560 (3.9)	565 (3.9)	- -
Permissible Installation Conditions	Dry concrete	Anchor Category	-	1						2	
		ϕ_d	-	0.65						0.55	
	Water-saturated concrete	Anchor Category	-	2							
		ϕ_{ws}	-	0.55							
Reduction for seismic tension		$\alpha_{N,seis}$	-	1.00						N/A	

For SI: 1 inch = 25.4 mm, 1 lbf = 4.448 N, 1 psi = 0.006897 MPa.
 For pound-inch units: 1 mm = 0.03937 inches, 1 N = 0.2248 lbf, 1 MPa = 145.0 psi.

¹ Bond strength values correspond to concrete compressive strength $f_c = 2,500$ psi (17.2 MPa). For concrete compressive strength, f_c , between 2,500 psi (17.2 MPa) and 8,000 psi (55.2 MPa), the tabulated characteristic bond strength may be increased by a factor of $(f_c / 2,500)^{0.1}$ [For SI: $(f_c / 17.2)^{0.1}$]. See Section 4.1.4 of this report for bond strength determination.

² Temperature range A: Maximum short term temperature = 130°F (55°C), maximum long term temperature = 110°F (43°C).
 Temperature range B: Maximum short term temperature = 176°F (80°C), maximum long term temperature = 110°F (43°C).
 Temperature range C: Maximum short term temperature = 210°F (99°C), maximum long term temperature = 162°F (72°C).

Short term elevated concrete temperatures are those that occur over brief intervals, e.g., as a result of diurnal cycling. Long term concrete temperatures are roughly constant over significant periods of time.

³ Hilti Hollow Drill Bit hole drilling not permitted for 1/2-inch threaded rod.

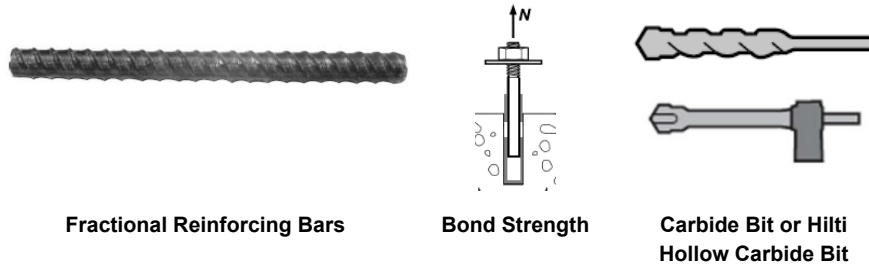

TABLE 10—BOND STRENGTH DESIGN INFORMATION FOR FRACTIONAL REINFORCING BARS IN HOLES DRILLED WITH A HAMMER DRILL AND CARBIDE BIT OR HILTI HOLLOW CARBIDE BIT¹

DESIGN INFORMATION		Symbol	Units	Nominal Reinforcing bar size (Rebar)								
				#3	#4	#5	#6	#7	#8	#9	#10	
Minimum anchor embedment depth		$h_{ef,min}$	in. (mm)	2 ³ / ₈ (60)	2 ³ / ₄ (70)	3 ¹ / ₈ (79)	3 ¹ / ₂ (89)	3 ¹ / ₂ (89)	4 (102)	4 ¹ / ₂ (114)	5 (127)	
Maximum anchor embedment depth		$h_{ef,max}$	in. (mm)	7 ¹ / ₂ (191)	10 (254)	12 ¹ / ₂ (318)	15 (381)	17 ¹ / ₂ (445)	20 (508)	22 ¹ / ₂ (572)	25 (635)	
Temperature Range ²	A	Characteristic bond strength in uncracked concrete	$\tau_{k,uncr}$	psi (MPa)	1,275 (8.8)	1,265 (8.7)	1,253 (8.6)	1,240 (8.5)	1,230 (8.5)	1,220 (8.4)	1,150 (7.9)	1,030 (7.1)
		Characteristic bond strength in cracked concrete	$\tau_{k,cr}$	psi (MPa)	610 (4.2)	670 (4.6)	725 (5.0)	775 (5.3)	780 (5.4)	790 (5.4)	795 (5.5)	805 (5.5)
	B	Characteristic bond strength in uncracked concrete	$\tau_{k,uncr}$	psi (MPa)	1,175 (8.1)	1,165 (8.0)	1,155 (8.0)	1,140 (7.9)	1,130 (7.8)	1,120 (7.7)	1,055 (7.3)	950 (6.6)
		Characteristic bond strength in cracked concrete	$\tau_{k,cr}$	psi (MPa)	565 (3.9)	615 (4.3)	665 (4.6)	715 (4.9)	720 (5.0)	725 (5.0)	730 (5.0)	740 (5.1)
	C	Characteristic bond strength in uncracked concrete	$\tau_{k,uncr}$	psi (MPa)	915 (6.3)	905 (6.2)	900 (6.2)	890 (6.1)	880 (6.1)	873 (6.0)	825 (5.7)	740 (5.1)
		Characteristic bond strength in cracked concrete	$\tau_{k,cr}$	psi (MPa)	430 (3.0)	475 (3.2)	510 (3.5)	545 (3.7)	550 (3.8)	555 (3.8)	560 (3.9)	565 (3.9)
Permissible Installation Conditions	Dry concrete & Water-saturated concrete	Anchor Category	-	1						2		
		ϕ_d & ϕ_{ws}	-	0.65						0.55		
Reduction for seismic tension		$\alpha_{N,seis}$	-	1.00								

For SI: 1 inch ≅ 25.4 mm, 1 lbf = 4.448 N, 1 psi = 0.006897 MPa.
 For pound-inch units: 1 mm = 0.03937 inches, 1 N = 0.2248 lbf, 1 MPa = 145.0 psi.

¹ Bond strength values correspond to concrete compressive strength $f'_c = 2,500$ psi (17.2 MPa). For concrete compressive strength, f'_c , between 2,500 psi (17.2 MPa) and 8,000 psi (55.2 MPa), the tabulated characteristic bond strength may be increased by a factor of $(f'_c / 2,500)^{0.1}$ [For SI: $(f'_c / 17.2)^{0.1}$]. See Section 4.1.4 of this report for bond strength determination.

² Temperature range A: Maximum short term temperature = 130°F (55°C), maximum long term temperature = 110°F (43°C).
 Temperature range B: Maximum short term temperature = 176°F (80°C), maximum long term temperature = 110°F (43°C).
 Temperature range C: Maximum short term temperature = 210°F (99°C), maximum long term temperature = 162°F (72°C).
 Short term elevated concrete temperatures are those that occur over brief intervals, e.g., as a result of diurnal cycling. Long term concrete temperatures are roughly constant over significant periods of time.



Metric Threaded Rod and EU Metric Reinforcing Bars

Steel Strength

TABLE 11—STEEL DESIGN INFORMATION FOR METRIC THREADED ROD AND EU METRIC REINFORCING BARS

DESIGN INFORMATION			Symbol	Units	Nominal rod diameter (mm) ¹								
					8	10	12	16	20	24	27	30	
Rod Outside Diameter			<i>d</i>	mm (in.)	8 (0.31)	10 (0.39)	12 (0.47)	16 (0.63)	20 (0.79)	24 (0.94)	27 (1.06)	30 (1.18)	
Rod effective cross-sectional area			<i>A_{se}</i>	mm ² (in. ²)	36.6 (0.057)	58.0 (0.090)	84.3 (0.131)	157 (0.243)	245 (0.380)	353 (0.547)	459 (0.711)	561 (0.870)	
ISO 898-1 Class 5.8	Nominal strength as governed by steel strength		<i>N_{sa}</i>	kN (lb)	18.3 (4,115)	29.0 (6,519)	42.0 (9,476)	78.5 (17,647)	122.5 (27,539)	176.5 (39,679)	229.5 (51,594)	280.5 (63,059)	
			<i>V_{sa}</i>	kN (lb)	11.0 (2,473)	17.4 (3,912)	25.5 (5,685)	47.0 (10,588)	73.5 (16,523)	106.0 (23,807)	137.5 (30,956)	168.5 (37,835)	
	Reduction for seismic shear		<i>α_{V,seis}</i>	-	0.70								
	Strength reduction factor for tension ²		<i>φ</i>	-	0.65								
	Strength reduction factor for shear ²		<i>φ</i>	-	0.60								
ISO 898-1 Class 8.8	Nominal strength as governed by steel strength		<i>N_{sa}</i>	kN (lb)	29.3 (6,580)	46.5 (10,431)	67.5 (15,161)	125.5 (28,236)	196.0 (44,063)	282.5 (63,486)	367.0 (82,550)	449.0 (100,894)	
			<i>V_{sa}</i>	kN (lb)	17.6 (3,957)	27.8 (6,250)	40.5 (9,097)	75.5 (16,942)	117.5 (26,438)	169.5 (38,092)	220.5 (49,530)	269.5 (60,537)	
	Reduction for seismic shear		<i>α_{V,seis}</i>	-	0.70								
	Strength reduction factor for tension ²		<i>φ</i>	-	0.65								
	Strength reduction factor for shear ²		<i>φ</i>	-	0.60								
ISO 3506-1 Class A4 Stainless ³	Nominal strength as governed by steel strength		<i>N_{sa}</i>	kN (lb)	25.6 (5,760)	40.6 (9,127)	59.0 (13,266)	109.9 (24,706)	171.5 (38,555)	247.1 (55,550)	183.1 (41,135)	223.8 (50,335)	
			<i>V_{sa}</i>	kN (lb)	15.4 (3,462)	24.4 (5,485)	35.4 (7,960)	65.9 (14,824)	102.9 (23,133)	148.3 (33,330)	109.9 (24,680)	134.3 (30,200)	
	Reduction for seismic shear		<i>α_{V,seis}</i>	-	0.70								
	Strength reduction factor for tension ²		<i>φ</i>	-	0.65								
	Strength reduction factor for shear ²		<i>φ</i>	-	0.60								
DESIGN INFORMATION			Symbol	Units	Reinforcing bar size								
					8	10	12	14	16	20	25	28	32
Nominal bar diameter			<i>d</i>	mm (in.)	8.0 (0.315)	10.0 (0.394)	12.0 (0.472)	14.0 (0.551)	16.0 (0.630)	20.0 (0.787)	25.0 (0.984)	28.0 (1.102)	32.0 (1.260)
Bar effective cross-sectional area			<i>A_{se}</i>	mm ² (in. ²)	50.3 (0.078)	78.5 (0.122)	113.1 (0.175)	153.9 (0.239)	201.1 (0.312)	314.2 (0.487)	490.9 (0.761)	615.8 (0.954)	804.2 (1.247)
DIN 488 BS:550/500	Nominal strength as governed by steel strength		<i>N_{sa}</i>	kN (lb)	27.6 (6,215)	43.0 (9,711)	62.0 (13,984)	84.5 (19,034)	110.5 (24,860)	173.0 (38,844)	270.0 (60,694)	338.5 (76,135)	442.5 (99,441)
			<i>V_{sa}</i>	kN (lb)	16.6 (3,730)	26.0 (5,827)	37.5 (8,390)	51.0 (11,420)	66.5 (14,916)	103.0 (23,307)	162.0 (36,416)	203.0 (45,681)	265.5 (59,665)
	Reduction for seismic shear		<i>α_{V,seis}</i>	-	0.70								
	Strength reduction factor for tension ²		<i>φ</i>	-	0.65								
	Strength reduction factor for shear ²		<i>φ</i>	-	0.60								

For SI: 1 inch ≡ 25.4 mm, 1 lbf = 4.448 N, 1 psi = 0.006897 MPa.
 For pound-inch units: 1 mm = 0.03937 inches, 1 N = 0.2248 lbf, 1 MPa = 145.0 psi

¹ Values provided for common rod material types are based on specified strengths and calculated in accordance with ACI 318-19 Eq (17.6.1.2) and Eq. (17.7.1.2.b) or ACI 318-14 Eq. (17.4.1.2) and Eq (17.5.1.2b), as applicable. Nuts and washers must be appropriate for the rod.
² The strength reduction factor applies when the load combinations from the IBC or ACI 318 are used, and the requirements of ACI 318-19 17.5.3 or ACI 318-14 17.3.3, as applicable, are met.
³ A4-70 Stainless (M8- M24); A4-502 Stainless (M27- M30)

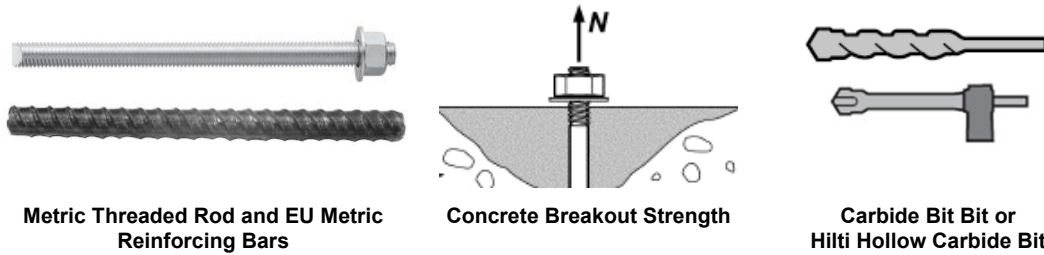

TABLE 12—CONCRETE BREAKOUT DESIGN INFORMATION FOR METRIC THREADED ROD AND EU METRIC REINFORCING BARS IN HOLES DRILLED WITH A HAMMER DRILL AND CARBIDE BIT OR HILTI HOLLOW CARBIDE BIT¹

DESIGN INFORMATION	Symbol	Units	Nominal rod diameter (mm)								
			8	10	12	16	20	24	27	30	
Minimum Embedment	$h_{ef,min}$	mm (in.)	60 (2.4)	60 (2.4)	70 (2.8)	80 (3.1)	90 (3.5)	96 (3.8)	108 (4.3)	120 (4.7)	
Maximum Embedment	$h_{ef,max}$	mm (in.)	160 (6.3)	200 (7.9)	240 (9.4)	320 (12.6)	400 (15.7)	480 (18.9)	540 (21.3)	600 (23.6)	
Min. anchor spacing ⁴	s_{min}	mm (in.)	40 (1.6)	50 (2.0)	60 (2.4)	80 (3.2)	100 (3.9)	120 (4.7)	135 (5.3)	150 (5.9)	
Min. edge distance ⁴	c_{min}	-	5d; or see Section 4.1.9 of this report for design with reduced minimum edge distances								
Minimum concrete thickness	h_{min}	mm (in.)	$h_{ef} + 30$ $(h_{ef} + 1\frac{1}{4})$			$h_{ef} + 2d_o^{(3)}$					
DESIGN INFORMATION	Symbol	Units	Reinforcing bar size								
			8	10	12	14	16	20	25	28	32
Minimum Embedment	$h_{ef,min}$	mm (in.)	60 (2.4)	60 (2.4)	70 (2.8)	75 (3.0)	80 (3.1)	90 (3.5)	100 (3.9)	112 (4.4)	128 (5.0)
Maximum Embedment	$h_{ef,max}$	mm (in.)	160 (6.3)	200 (7.9)	240 (9.4)	280 (11.0)	320 (12.6)	400 (15.7)	500 (19.7)	560 (22.0)	640 (25.2)
Min. anchor spacing ⁴	s_{min}	mm (in.)	40 (1.6)	50 (2.0)	60 (2.4)	80 (3.2)	100 (3.9)	120 (4.7)	135 (5.3)	140 (5.5)	160 (6.3)
Min. edge distance ⁴	c_{min}	-	5d; or see Section 4.1.9 of this report for design with reduced minimum edge distances								
Minimum concrete thickness	h_{min}	mm (in.)	$h_{ef} + 30$ $(h_{ef} + 1\frac{1}{4})$			$h_{ef} + 2d_o^{(3)}$					
Critical edge distance – splitting (for uncracked concrete)	c_{ac}	-	See Section 4.1.10 of this report.								
Effectiveness factor for uncracked concrete	$k_{c,uncr}$	SI (in-lb)					10 (24)				
Effectiveness factor for cracked concrete	$k_{c,cr}$	SI (in-lb)					7.1 (17)				
Strength reduction factor for tension, concrete failure modes, Condition B (supplemental reinforcement not present) ²	ϕ	-					0.65				
Strength reduction factor for shear, concrete failure modes, Condition B (supplemental reinforcement not present) ²	ϕ	-					0.70				

For SI: 1 inch \equiv 25.4 mm, 1 lbf = 4.448 N, 1 psi = 0.006897 MPa
 For pound-inch units: 1 mm = 0.03937 inches, 1 N = 0.2248 lbf, 1 MPa = 145.0 psi.

¹ For additional setting information, see installation instructions in [Figure 4](#).

² The strength reduction factor applies when the load combinations from the IBC or ACI 318 are used, and the requirements of ACI 318-19 17.5.3 or ACI 318-14 17.3.3, as applicable, are met.

³ d_o = drill bit diameter.

⁴ For installations with 1³/₄-inch edge distance, refer to Section 4.1.9 for spacing and maximum torque requirements.

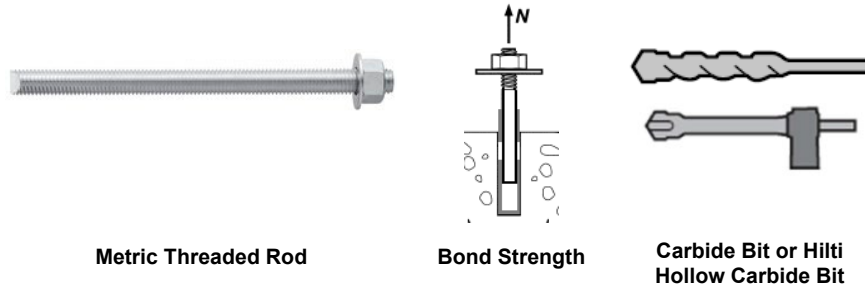

TABLE 13—BOND STRENGTH DESIGN INFORMATION FOR METRIC THREADED ROD IN HOLES DRILLED WITH A HAMMER DRILL AND CARBIDE BIT OR HILTI HOLLOW CARBIDE BIT^{1,3}

DESIGN INFORMATION		Symbol	Units	Nominal rod diameter (mm)								
				8	10	12	16	20	24	27	30	
Minimum anchor embedment depth		$h_{ef,min}$	mm (in.)	60 (2.4)	60 (2.4)	70 (2.8)	80 (3.1)	90 (3.5)	96 (3.8)	108 (4.3)	120 (4.7)	
Maximum anchor embedment depth		$h_{ef,max}$	mm (in.)	160 (6.3)	200 (7.9)	240 (9.4)	320 (12.6)	400 (15.7)	480 (18.9)	540 (21.3)	600 (23.6)	
Temperature Range ²	A	Characteristic bond strength in uncracked concrete	$\tau_{k,uncr}$	MPa (psi)	10.2 (1,490)	10.2 (1,490)	10.2 (1,490)	10.2 (1,490)	10.1 (1,470)	9.1 (1,320)	8.3 (1,210)	7.6 (1,095)
		Characteristic bond strength in cracked concrete	$\tau_{k,cr}$	MPa (psi)	-	4.3 (620)	4.5 (650)	4.9 (715)	5.3 (770)	5.4 (780)	-	-
	B	Characteristic bond strength in uncracked concrete	$\tau_{k,uncr}$	MPa (psi)	10.0 (1,450)	10.0 (1,450)	10.0 (1,450)	10.0 (1,450)	9.3 (1,355)	8.4 (1,215)	7.7 (1,115)	7.0 (1,010)
		Characteristic bond strength in cracked concrete	$\tau_{k,cr}$	MPa (psi)	-	3.9 (570)	4.1 (600)	4.5 (660)	4.9 (710)	4.9 (715)	-	-
	C	Characteristic bond strength in uncracked concrete	$\tau_{k,uncr}$	MPa (psi)	8.8 (1,270)	8.8 (1,270)	8.8 (1,270)	8.0 (1,165)	7.3 (1,055)	6.6 (950)	6.0 (865)	5.4 (785)
		Characteristic bond strength in cracked concrete	$\tau_{k,cr}$	MPa (psi)	-	3.1 (440)	3.2 (465)	3.5 (515)	3.8 (550)	3.8 (560)	-	-
Permissible Installation Conditions	Dry concrete	Anchor Category	-	1							2	
		ϕ_d	-	0.65							0.55	
	Water-saturated concrete	Anchor Category	-	2								
		ϕ_{ws}	-	0.55								
Reduction for seismic tension		$\alpha_{N,seis}$	-	1.00						N/A		

For SI: 1 inch ≅ 25.4 mm, 1 lbf = 4.448 N, 1 psi = 0.006897 MPa.

For pound-inch units: 1 mm = 0.03937 inches, 1 N = 0.2248 lbf, 1 MPa = 145.0 psi.

¹ Bond strength values correspond to concrete compressive strength $f'_c = 2,500$ psi (17.2 MPa). For concrete compressive strength, f'_c , between 2,500 psi (17.2 MPa) and 8,000 psi (55.2 MPa), the tabulated characteristic bond strength may be increased by a factor of $(f'_c / 2,500)^{0.1}$ [For SI: $(f'_c / 17.2)^{0.1}$]. See Section 4.1.4 of this report for bond strength determination.

² Temperature range A: Maximum short term temperature = 130°F (55°C), maximum long term temperature = 110°F (43°C).

Temperature range B: Maximum short term temperature = 176°F (80°C), maximum long term temperature = 110°F (43°C).

Temperature range C: Maximum short term temperature = 210°F (99°C), maximum long term temperature = 162°F (72°C).

Short term elevated concrete temperatures are those that occur over brief intervals, e.g., as a result of diurnal cycling. Long term concrete temperatures are roughly constant over significant periods of time.

³ Hilti Hollow Drill Bit not permitted for 10 mm and 12 mm threaded rod.

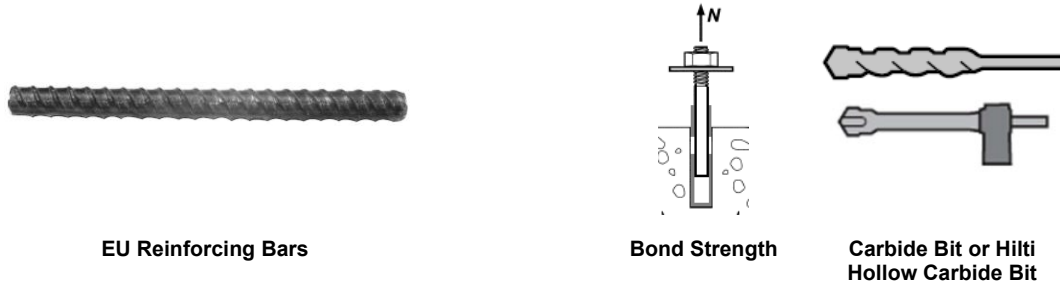

TABLE 14—BOND STRENGTH DESIGN INFORMATION FOR EU REINFORCING BARS IN HOLES DRILLED WITH A HAMMER DRILL AND CARBIDE BIT OR HILTI HOLLOW CARBIDE BIT^{1,3}

DESIGN INFORMATION		Symbol	Units	Nominal Reinforcing bar size (Rebar)									
				8	10	12	14	16	20	25	28	32	
Minimum anchor embedment depth		$h_{ef,min}$	mm (in.)	60 (2.4)	60 (2.4)	70 (2.8)	75 (3.0)	80 (3.1)	90 (3.5)	100 (3.9)	112 (4.4)	128 (5.0)	
Maximum anchor embedment depth		$h_{ef,max}$	mm (in.)	160 (6.3)	200 (7.9)	240 (9.4)	280 (11.0)	320 (12.6)	400 (15.7)	500 (19.7)	560 (22.0)	640 (25.2)	
Temperature Range ²	A	Characteristic bond strength in uncracked concrete	$\tau_{k,uncr}$	MPa (psi)	6.2 (900)	6.3 (915)	6.4 (925)	6.5 (940)	6.6 (950)	6.7 (975)	7.0 (1010)	7.1 (1025)	7.0 (1020)
		Characteristic bond strength in cracked concrete	$\tau_{k,cr}$	MPa (psi)	- (-)	4.3 (620)	4.5 (650)	4.7 (680)	4.9 (715)	5.3 (770)	5.4 (785)	5.5 (795)	5.5 (800)
	B	Characteristic bond strength in uncracked concrete	$\tau_{k,uncr}$	MPa (psi)	5.7 (830)	5.8 (840)	5.9 (855)	6.0 (865)	6.0 (875)	6.2 (900)	6.4 (930)	6.5 (945)	6.5 (940)
		Characteristic bond strength in cracked concrete	$\tau_{k,cr}$	MPa (psi)	- (-)	3.9 (570)	4.1 (600)	4.3 (630)	4.5 (660)	4.9 (710)	5.0 (725)	5.0 (730)	5.1 (740)
	C	Characteristic bond strength in uncracked concrete	$\tau_{k,uncr}$	MPa (psi)	4.5 (650)	4.5 (655)	4.6 (665)	4.7 (675)	4.7 (685)	4.8 (700)	5.0 (725)	5.1 (735)	5.1 (745)
		Characteristic bond strength in cracked concrete	$\tau_{k,cr}$	MPa (psi)	- (-)	3.0 (440)	3.2 (465)	3.4 (490)	3.5 (515)	3.8 (550)	3.8 (555)	3.9 (560)	3.9 (565)
Permissible Installation Conditions	Dry concrete & Water-saturated concrete	Anchor Category	-	1							2		
		ϕ_d & ϕ_{ws}	-	0.65							0.55		
Reduction for seismic tension		$\alpha_{N,seis}$	-	1.00									

For SI: 1 inch \equiv 25.4 mm, 1 lbf = 4.448 N, 1 psi = 0.006897 MPa.
 For pound-inch units: 1 mm = 0.03937 inches, 1 N = 0.2248 lbf, 1 MPa = 145.0 psi.

¹ Bond strength values correspond to concrete compressive strength $f'_c = 2,500$ psi (17.2 MPa). For concrete compressive strength, f'_c , between 2,500 psi (17.2 MPa) and 8,000 psi (55.2 MPa), the tabulated characteristic bond strength may be increased by a factor of $(f'_c / 2,500)^{0.1}$ [For SI: $(f'_c / 17.2)^{0.1}$]. See Section 4.1.4 of this report for bond strength determination.

² Temperature range A: Maximum short term temperature = 130°F (55°C), maximum long term temperature = 110°F (43°C).

Temperature range B: Maximum short term temperature = 176°F (80°C), maximum long term temperature = 110°F (43°C).

Temperature range C: Maximum short term temperature = 210°F (99°C), maximum long term temperature = 162°F (72°C).

Short term elevated concrete temperatures are those that occur over brief intervals, e.g., as a result of diurnal cycling. Long term concrete temperatures are roughly constant over significant periods of time.

³ Hilti Hollow Drill Bit not permitted for 10 mm and 12 mm Rebar.



Canadian Reinforcing Bars

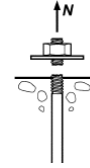

Steel Strength

TABLE 15—STEEL DESIGN INFORMATION FOR CANADIAN METRIC REINFORCING BARS¹

DESIGN INFORMATION	Symbol	Units	Bar size					
			10 M	15 M	20 M	25 M	30 M	
Nominal bar diameter	d	mm (in.)	11.3 (0.445)	16.0 (0.630)	19.5 (0.768)	25.2 (0.992)	29.9 (1.177)	
Bar effective cross-sectional area	A_{se}	mm ² (in. ²)	100.3 (0.155)	201.1 (0.312)	298.6 (0.463)	498.8 (0.773)	702.2 (1.088)	
CSA G30	Nominal strength as governed by steel strength	N_{sa}	kN (lb)	54.0 (12,175)	108.5 (24,408)	161.5 (36,255)	270.0 (60,548)	380.0 (85,239)
		V_{sa}	kN (lb)	32.5 (7,305)	65.0 (14,645)	96.8 (21,755)	161.6 (36,330)	227.5 (51,145)
	Reduction for seismic shear	$\alpha_{V,seis}$	-	0.70				
	Strength reduction factor for tension ²	ϕ	-	0.65				
	Strength reduction factor for shear ²	ϕ	-	0.60				

For SI: 1 inch \equiv 25.4 mm, 1 lbf = 4.448 N, 1 psi = 0.006897 MPa.
 For pound-inch units: 1 mm = 0.03937 inches, 1 N = 0.2248 lbf, 1 MPa = 145.0 psi

¹ Values provided for common rod material types based on specified strengths and calculated in accordance with ACI 318-19 Eq. (17.6.1.2) and Eq. (17.7.1.2b) or ACI 318-14 Eq. (17.4.1.2) and Eq. (17.5.1.2b), as applicable. Nuts and washers must be appropriate for the rod.

² The strength reduction factor applies when the load combinations from the IBC or ACI 318 are used, and the requirements of ACI 318-19 17.5.3 or ACI 318-14 17.3.3, as applicable, are met.



Canadian Reinforcing Bars

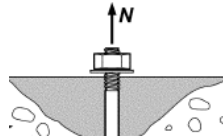

Concrete Breakout Strength

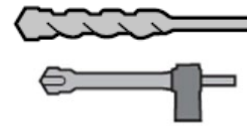

Carbide Bit or Hilti Hollow Carbide Bit

TABLE 16—CONCRETE BREAKOUT DESIGN INFORMATION FOR CANADIAN METRIC REINFORCING BARS IN HOLES DRILLED WITH A HAMMER DRILL AND CARBIDE BIT OR HILTI HOLLOW CARBIDE BIT ¹

DESIGN INFORMATION	Symbol	Units	Bar size				
			10 M	15 M	20 M	25 M	30 M
Effectiveness factor for uncracked concrete	$k_{c,uncr}$	SI (in-lb)	10 (24)				
Effectiveness factor for cracked concrete	$k_{c,cr}$	SI (in-lb)	7.1 (24)				
Minimum Embedment	$h_{ef,min}$	mm (in.)	70 (2.8)	80 (3.1)	90 (3.5)	101 (4.0)	120 (4.7)
Maximum Embedment	$h_{ef,max}$	mm (in.)	226 (8.9)	320 (12.6)	390 (15.4)	504 (19.8)	598 (23.5)
Min. bar spacing ³	s_{min}	mm (in.)	57 (2.2)	80 (3.1)	98 (3.8)	126 (5.0)	150 (5.9)
Min. edge distance ³	c_{min}	mm (in.)	5d; or see Section 4.1.9 of this report for design with reduced minimum edge distances				
Minimum concrete thickness	h_{min}	mm (in.)	$h_{ef} + 30$ ($h_{ef} + 1\frac{1}{4}$)	$h_{ef} + 2d_o$ ⁽⁴⁾			
Critical edge distance – splitting (for uncracked concrete)	c_{ac}	-	See Section 4.1.10 of this report.				
Strength reduction factor for tension, concrete failure modes, Condition B (supplemental reinforcement not present) ²	ϕ	-	0.65				
Strength reduction factor for shear, concrete failure modes, Condition B (supplemental reinforcement not present) ²	ϕ	-	0.70				

For SI: 1 inch \equiv 25.4 mm, 1 lbf = 4.448 N, 1 psi = 0.006897 MPa.
 For pound-inch units: 1 mm = 0.03937 inches, 1 N = 0.2248 lbf, 1 MPa = 145.0 psi

¹ Additional setting information is described in [Figure 4](#), Manufacturers Printed Installation Instructions (MPII).

² The strength reduction factor applies when the load combinations from the IBC or ACI 318 are used, and the requirements of ACI 318-19 17.5.3 or ACI 318-14 17.3.3, as applicable, are met.

³ For installations with $1\frac{3}{4}$ -inch edge distance, refer to Section 4.1.9 for spacing and maximum torque requirements.

⁴ d_o = hole diameter.

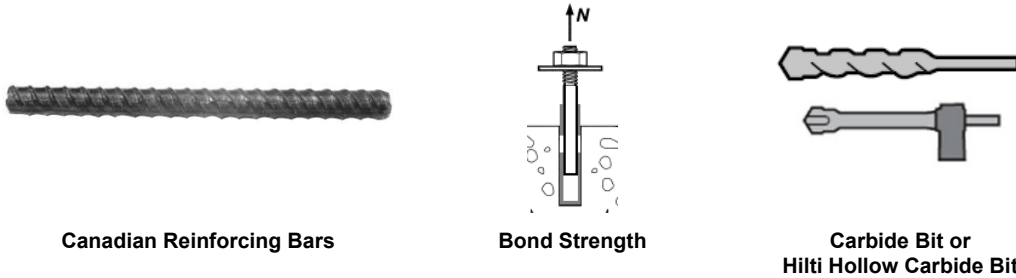

TABLE 17—BOND STRENGTH DESIGN INFORMATION FOR CANADIAN METRIC REINFORCING BARS IN HOLES DRILLED WITH A HAMMER DRILL AND CARBIDE BIT OR HILTI HOLLOW CARBIDE BIT ¹

DESIGN INFORMATION		Symbol	Units	Bar Size					
				10 M	15 M	20 M	25 M	30 M	
Minimum anchor embedment depth		$h_{ef,min}$	mm (in.)	70 (2.8)	80 (3.1)	90 (3.5)	101 (4.0)	120 (4.7)	
Maximum anchor embedment depth		$h_{ef,max}$	mm (in.)	226 (8.9)	320 (12.6)	390 (15.4)	504 (19.8)	598 (23.5)	
Temperature Range ²	A	Characteristic bond strength in uncracked concrete	$\tau_{k,uncr}$	MPa (psi)	8.8 (1,275)	8.7 (1,255)	8.6 (1,240)	8.4 (1,220)	7.6 (1,095)
		Characteristic bond strength in cracked concrete	$\tau_{k,cr}$	MPa (psi)	4.3 (625)	5.0 (725)	5.4 (775)	5.4 (790)	5.5 (800)
	B	Characteristic bond strength	$\tau_{k,uncr}$	MPa (psi)	8.1 (1,175)	8.0 (1,155)	7.9 (1,140)	7.7 (1,120)	7.0 (1,010)
		Characteristic bond strength in cracked concrete	$\tau_{k,cr}$	MPa (psi)	4.0 (575)	4.6 (665)	4.9 (715)	5.0 (725)	5.1 (735)
	C	Characteristic bond strength	$\tau_{k,uncr}$	MPa (psi)	6.3 (915)	6.2 (900)	6.1 (885)	6.0 (875)	5.4 (785)
		Characteristic bond strength in cracked concrete	$\tau_{k,cr}$	MPa (psi)	3.0 (440)	3.5 (510)	3.8 (545)	3.8 (555)	3.9 (560)
Permissible Installation Conditions	Dry concrete & Water-saturated concrete	Anchor Category	-	1				2	
		ϕ_d & ϕ_{ws}	-	0.65				0.55	
Reduction for seismic tension		$\alpha_{N,seis}$	-	1.00					

For SI: 1 inch ≅ 25.4 mm, 1 lbf = 4.448 N, 1 psi = 0.006897 MPa.

For pound-inch units: 1 mm = 0.03937 inches, 1 N = 0.2248 lbf, 1 MPa = 145.0 psi

¹ Bond strength values correspond to concrete compressive strength $f'_c = 2,500$ psi (17.2 MPa). For concrete compressive strength, f'_c , between 2,500 psi (17.2 MPa) and 8,000 psi (55.2 MPa), the tabulated characteristic bond strength may be increased by a factor of $(f'_c / 2,500)^{0.1}$ [For SI: $(f'_c / 17.2)^{0.1}$]. See Section 4.1.4 of this report for bond strength determination.

² Temperature range A: Maximum short term temperature = 130°F (55°C), Maximum long term temperature = 110°F (43°C).

Temperature range B: Maximum short term temperature = 176°F (80°C), Maximum long term temperature = 110°F (43°C).

Temperature range C: Maximum short term temperature = 210°F (99°C), Maximum long term temperature = 162°F (72°C).

Short term elevated concrete temperatures are those that occur over brief intervals, e.g., as a result of diurnal cycling. Long term concrete temperatures are roughly constant over significant periods of time.

³ Hilti Hollow Drill Bit not permitted for 10M Rebar.

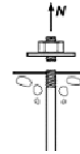

Fractional and Metric HIS-N and HIS-RN Internal Threaded Insert

Steel Strength

TABLE 18—STEEL DESIGN INFORMATION FOR FRACTIONAL AND METRIC HIS-N AND HIS-RN THREADED INSERTS¹

DESIGN INFORMATION	Symbol	Units	Nominal Bolt/Cap Screw Diameter				Units	Nominal Bolt/Cap Screw Diameter					
			(in.) Fractional					(mm) Metric					
			3/8	1/2	5/8	3/4		8	10	12	16	20	
HIS Insert O.D.	<i>D</i>	in. (mm)	0.65 (16.5)	0.81 (20.5)	1.00 (25.4)	1.09 (27.6)	mm (in.)	12.5 (0.49)	16.5 (0.65)	20.5 (0.81)	25.4 (1.00)	27.6 (1.09)	
HIS insert length	<i>l</i>	in. (mm)	4.33 (110)	4.92 (125)	6.69 (170)	8.07 (205)	mm (in.)	90 (3.54)	110 (4.33)	125 (4.92)	170 (6.69)	205 (8.07)	
Bolt effective cross-sectional area	<i>A_{se}</i>	in. ² (mm ²)	0.0775 (50)	0.1419 (92)	0.2260 (146)	0.3345 (216)	mm ² (in. ²)	36.6 (0.057)	58 (0.090)	84.3 (0.131)	157 (0.243)	245 (0.380)	
HIS insert effective cross-sectional area	<i>A_{insert}</i>	in. ² (mm ²)	0.178 (115)	0.243 (157)	0.404 (260)	0.410 (265)	mm ² (in. ²)	51.5 (0.080)	108 (0.167)	169.1 (0.262)	256.1 (0.397)	237.6 (0.368)	
ASTM A193 B7	Nominal steel strength – ASTM A193 B7 ³ bolt/cap screw	<i>N_{sa}</i>	lb (kN)	9,690 (43.1)	17,740 (78.9)	28,250 (125.7)	41,815 (186.0)	kN (lb)	-	-	-	-	-
		<i>V_{sa}</i>	lb (kN)	5,815 (25.9)	10,645 (47.3)	16,950 (75.4)	25,090 (111.6)	kN (lb)	-	-	-	-	-
	Nominal steel strength – HIS-N insert	<i>N_{sa}</i>	lb (kN)	12,650 (56.3)	16,195 (72.0)	26,925 (119.8)	27,360 (121.7)	kN (lb)	-	-	-	-	-
ASTM A193 Grade B8M SS	Nominal steel strength – ASTM A193 Grade B8M SS bolt/cap screw	<i>N_{sa}</i>	lb (kN)	8,525 (37.9)	15,610 (69.4)	24,860 (110.6)	36,795 (163.7)	kN (lb)	-	-	-	-	-
		<i>V_{sa}</i>	lb (kN)	5,115 (22.8)	9,365 (41.7)	14,915 (66.3)	22,075 (98.2)	kN (lb)	-	-	-	-	-
	Nominal steel strength – HIS-RN insert	<i>N_{sa}</i>	lb (kN)	17,165 (76.3)	23,430 (104.2)	38,955 (173.3)	39,535 (175.9)	kN (lb)	-	-	-	-	-
ISO 898-1 Class 8.8	Nominal steel strength – ISO 898-1 Class 8.8 bolt/cap screw	<i>N_{sa}</i>	lb (kN)	-	-	-	-	kN (lb)	29.3 (6,580)	46.4 (10,430)	67.4 (15,160)	125.6 (28,235)	196.0 (44,065)
		<i>V_{sa}</i>	lb (kN)	-	-	-	-	kN (lb)	17.6 (3,950)	27.8 (6,260)	40.5 (9,100)	75.4 (16,940)	117.6 (26,440)
	Nominal steel strength – HIS-N insert	<i>N_{sa}</i>	lb (kN)	-	-	-	-	kN (lb)	25.0 (5,669)	53.0 (11,894)	78.0 (17,488)	118.0 (26,483)	110.0 (24,573)
ISO 3506-1 Class A4-70 Stainless	Nominal steel strength – ISO 3506-1 Class A4-70 Stainless bolt/cap screw	<i>N_{sa}</i>	lb (kN)	-	-	-	-	kN (lb)	25.5 (5,760)	40.5 (9,127)	59.0 (13,266)	110.0 (24,706)	171.5 (38,555)
		<i>V_{sa}</i>	lb (kN)	-	-	-	-	kN (lb)	15.5 (3,456)	24.5 (5,476)	35.5 (7,960)	66.0 (14,824)	103.0 (23,133)
	Nominal steel strength – HIS-RN insert	<i>N_{sa}</i>	lb (kN)	-	-	-	-	kN (lb)	36.0 (8,099)	75.5 (16,991)	118.5 (26,612)	179.5 (40,300)	166.5 (37,394)
Strength reduction factor for tension ²	ϕ	-	0.65				-	0.65					
Strength reduction factor for shear ²	ϕ	-	0.60				-	0.60					

For SI: 1 inch = 25.4 mm, 1 lbf = 4.448 N, 1 psi = 0.006897MPa.

For pound-inch units: 1 mm = 0.03937 inches, 1 N = 0.2248 lbf, 1 MPa = 145.0 psi

¹ Values provided for common rod material types are based on specified strengths and calculated in accordance with ACI 318-19 Eq. (17.6.1.2) and Eq. (17.7.1.2b) or ACI 318-14 Eq. (17.4.1.2) and Eq. (17.5.1.2b), as applicable. Nuts and washers must be appropriate for the rod.

² The strength reduction factor applies when the load combinations from the IBC or ACI 318 are used, and the requirements of ACI 318-19 17.5.3 or ACI 318-14 17.3.3, as applicable, are met.

³ For the calculation of the design steel strength in tension and shear for the bolt or screw, the ϕ factor for ductile steel failure according to ACI 318-19 17.5.3 or ACI 318-14 17.3.3, as applicable, can be used.

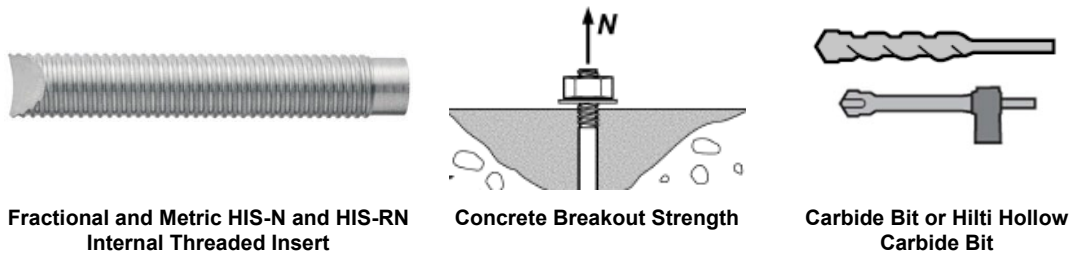

TABLE 19—CONCRETE BREAKOUT DESIGN INFORMATION FOR FRACTIONAL AND METRIC HILTI HIS-N AND HIS-RN INSERTS IN HOLES DRILLED WITH A HAMMER DRILL AND CARBIDE BIT OR HILTI HOLLOW CARBIDE BIT¹

DESIGN INFORMATION	Symbol	Units	Nominal Bolt/Cap Screw Diameter (in.) Fractional				Units	Nominal Bolt/Cap Screw Diameter (mm) Metric				
			3/8	1/2	5/8	3/4		8	10	12	16	20
Effectiveness factor for uncracked concrete	$k_{c,uncr}$	in-lb (SI)	24 (10)				SI (in-lb)	10 (24)				
Effective embedment depth	h_{ef}	in. (mm)	4 ^{3/8} (110)	5 (125)	6 ^{3/4} (170)	8 ^{1/8} (205)	mm (in.)	90 (3.5)	110 (4.3)	125 (4.9)	170 (6.7)	205 (8.1)
Min. anchor spacing ³	s_{min}	in. (mm)	3 ^{1/4} (83)	4 (102)	5 (127)	5 ^{1/2} (140)	mm (in.)	63 (2.5)	83 (3.25)	102 (4.0)	127 (5.0)	140 (5.5)
Min. edge distance ³	c_{min}	in. (mm)	3 ^{1/4} (83)	4 (102)	5 (127)	5 ^{1/2} (140)	mm (in.)	63 (2.5)	83 (3.25)	102 (4.0)	127 (5.0)	140 (5.5)
Minimum concrete thickness	h_{min}	in. (mm)	5.9 (150)	6.7 (170)	9.1 (230)	10.6 (270)	mm (in.)	120 (4.7)	150 (5.9)	170 (6.7)	230 (9.1)	270 (10.6)
Critical edge distance – splitting (for uncracked concrete)	c_{ac}	-	See Section 4.1.10 of this report				-	See Section 4.1.10 of this report				
Strength reduction factor for tension, concrete failure modes, Condition B (supplemental reinforcement not present) ²	ϕ	-	0.65				-	0.65				
Strength reduction factor for shear, concrete failure modes, Condition B (supplemental reinforcement not present) ²	ϕ	-	0.70				-	0.70				

For SI: 1 inch ≅ 25.4 mm, 1 lbf = 4.448 N, 1 psi = 0.006897MPa.
 For pound-inch units: 1 mm = 0.03937 inches, 1 N = 0.2248 lbf, 1 MPa = 145.0 psi

¹ Additional setting information is described in [Figure 4](#), Manufacturers Printed Installation Instructions (MPII).

² The strength reduction factor applies when the load combinations from the IBC or ACI 318 are used, and the requirements of ACI 318-19 17.5.3 or ACI 318-14 17.3.3, as applicable, are met.

³ For installations with 1^{3/4}-inch edge distance, refer to Section 4.1.9 for spacing and maximum torque requirements.

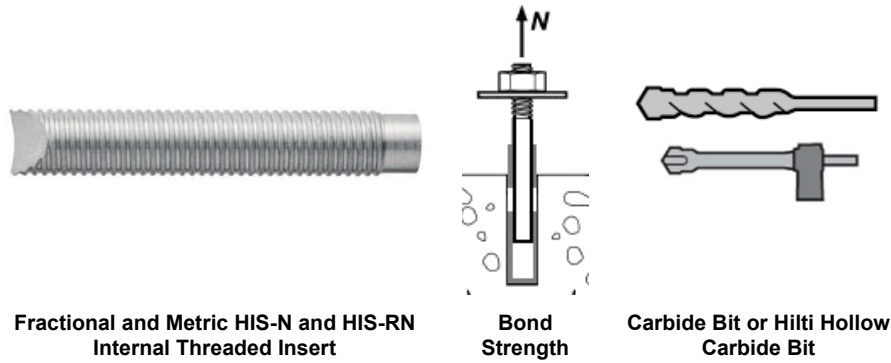

TABLE 20—BOND STRENGTH DESIGN INFORMATION FOR FRACTIONAL AND METRIC HILTI HIS-N AND HIS-RN INSERTS IN HOLES DRILLED WITH A HAMMER DRILL AND CARBIDE BIT OR HILTI HOLLOW CARBIDE BIT¹

DESIGN INFORMATION		Symbol	Units	Nominal Bolt/Cap Screw Diameter (in.) Fractional				Units	Nominal Bolt/Cap Screw Diameter (mm) Metric					
				3/8	1/2	5/8	3/4		8	10	12	16	20	
Effective embedment depth		h_{ef}	in. (mm)	4 ³ / ₈ (110)	5 (125)	6 ³ / ₄ (170)	8 ¹ / ₈ (205)	mm (in.)	90 (3.5)	110 (4.3)	125 (4.9)	170 (6.7)	205 (8.1)	
HIS Insert O.D.		D	in. (mm)	0.65 (16.5)	0.81 (20.5)	1.00 (25.4)	1.09 (27.6)	mm (in.)	12.5 (0.49)	16.5 (0.65)	20.5 (0.81)	25.4 (1.00)	27.6 (1.09)	
Temperature range ²	A	Characteristic bond strength	$\tau_{k,uncr}$	psi (MPa)	1,375 (9.5)	1,270 (8.8)	1,100 (7.6)	1,030 (7.1)	MPa (psi)	9.5 (1,375)	9.5 (1,375)	8.8 (1,270)	7.6 (1,100)	7.1 (1,030)
	B	Characteristic bond strength	$\tau_{k,uncr}$	psi (MPa)	1,270 (8.8)	1,170 (8.1)	1,015 (7.0)	945 (6.5)	MPa (psi)	8.8 (1,270)	8.8 (1,270)	8.1 (1,170)	7.0 (1,015)	6.5 (945)
	C	Characteristic bond strength	$\tau_{k,uncr}$	psi (MPa)	990 (6.8)	910 (6.3)	790 (5.4)	740 (5.1)	MPa (psi)	6.8 (990)	6.8 (990)	6.3 (910)	5.4 (790)	5.1 (740)
Permissible installation conditions	Dry concrete	Anchor Category	-	1			2	-	1			2		
		ϕ_d	-	0.65			0.55	-	0.65			0.55		
	Water saturated concrete	Anchor Category	-	2			-	-	2			-		
		ϕ_{ws}	-	0.55			-	-	0.55			-		

For SI: 1 inch = 25.4 mm, 1 lbf = 4.448 N, 1 psi = 0.006897 MPa.
 For pound-inch units: 1 mm = 0.03937 inches, 1 N = 0.2248 lbf, 1 MPa = 145.0 psi

¹ Bond strength values correspond to concrete compressive strength $f'_c = 2,500$ psi (17.2 MPa). For concrete compressive strength, f'_c , between 2,500 psi (17.2 MPa) and 8,000 psi (55.2 MPa), the tabulated characteristic bond strength may be increased by a factor of $(f'_c / 2,500)^{0.1}$ [For SI: $(f'_c / 17.2)^{0.1}$]. See Section 4.1.4 of this report for bond strength determination.

² Temperature range A: Maximum short term temperature = 130°F (55°C), Maximum long term temperature = 110°F (43°C).
 Temperature range B: Maximum short term temperature = 176°F (80°C), Maximum long term temperature = 110°F (43°C).
 Temperature range C: Maximum short term temperature = 210°F (99°C), Maximum long term temperature = 162°F (72°C).

Short term elevated concrete temperatures are those that occur over brief intervals, e.g., as a result of diurnal cycling. Long term concrete temperatures are roughly constant over significant periods of time.



FIGURE 3—HILTI HIT-HY 100 ANCHORING SYSTEM AND ANCHOR ELEMENTS

HILTI

Hilti HIT-HY 100

Instruction for use [en](#)
 Mode d'emploi [fr](#)
 Manual de instrucciones [es](#)
 Instruções de utilização [pt](#)
 Инструкция по применению [ru](#)

Danger

(A, B) (A) (B)

Contains: hydroxypropyl methacrylate(A), boric acid (A), dibenzoyl peroxide(B)

May cause an allergic skin reaction. (A,B)
 Causes serious eye irritation (A)
 May damage fertility or the unborn child. (A)
 Very toxic to aquatic life. (B)

ICC ES
 ICC ESR 3574

HILTI HIT-HY 100

en Dry concrete Water saturated concrete Hammer drilling Hollow drill bit

en Uncracked concrete Cracked concrete Temperature of base material

en Threaded rod Threaded sleeve Rebar cartridge temperature Working time Curing time

HILTI HIT-HY 100

HIT-HY 100		HIT-V, HAS Rebar HIS-N	
[°C]	[°F]	t _{work}	t _{cure}
-10...-5	14...22	3 h	12 h
-4...0	23...31	40 min	4 h
1...5	32...40	20 min	2 h
6...10	41...50	8 min	60 min
11...20	51...68	5 min	30 min
21...30	69...86	3 min	30 min
31...40	87...104	2 min	30 min

Ø	HAS HIT-V	HIS-N	Rebar	HIT-RB	HIT-SZ	HIT-DL	HIT-OHC
d ₀ [inch]	d [inch]			[inch]	[inch]	[inch]	Art. No.
7/16	3/8	-	-	7/16	-	-	387551
1/2	-	-	#3	1/2	1/2	1/2	
9/16	1/2	-	10M	9/16	9/16	9/16	
5/8	-	-	#4	5/8	5/8	9/16	
11/16	-	3/8	-	11/16	11/16	11/16	
3/4	5/8	-	15M #5	3/4	3/4	3/4	387552
7/8	3/4	1/2	#6	7/8	7/8	7/8	
1	7/8	-	20M #7	1	1	1	
1 1/8	1	5/8	#8	1 1/8	1 1/8	1	
1 1/4	-	3/4	25M	1 1/4	1 1/4	1	
1 3/8	1 1/4	-	#9	1 3/8	1 3/8	1 3/8	
1 1/2	-	-	30M #10	1 1/2	1 1/2	1 3/8	

HIT-DL: h_{ef} > 10" HIT-RB: h_{ef} > 20d

HIT-RE-M	HIT-OHW
Art. No.	Art. No.
337111	HDM 330, HDM 500 HDE 500-A22

Ø	h _{ef}	Art. No. 60579	Art. No. 381215
d ₀ [inch]	[inch]		
7/16" ... 3/4"	2 3/8" ... 10d	✓	-
7/16" ... 1 1/8"	2 3/8" ... 20"	-	✓
1 1/4" ... 1 1/2"	4" ... 25"	-	✓

Ø	HIT-V	HIS-N	Rebar	HIT-RB	HIT-SZ	HIT-DL	HIT-OHC
d ₀ [mm]	d [mm]			[mm]	[mm]		Art. No.
10	8	-	-	10	-	-	387551
12	10	-	8	12	12	12	
14	12	8	10	14	14	14	
16	-	-	12	16	16	16	
18	16	10	14	18	18	18	
20	-	-	16	20	20	20	
22	20	12	18	22	22	20	
25	-	-	20	25	25	25	
28	24	16	22	28	28	25	
30	27	-	-	30	30	25	
32	-	20	24/25	32	32	32	
35	30	-	26/28	35	35	32	
37	-	-	30	37	37	32	
40	-	-	32	40	40	32	

HIT-DL: h_{ef} > 250 mm HIT-RB: h_{ef} > 20d

HIT-RE-M	HIT-OHW
Art. No.	Art. No.
337111	HDM 330 / 500 HDE 500-A18

Ø	h _{ef}	Art. No. 60579	Art. No. 381215
d ₀ [mm]	[mm]		
10 ... 20	60 ... 10d	✓	-
10 ... 32	60 ... 500	-	✓
35 ... 40	100 ... 640	-	✓

FIGURE 4—MANUFACTURER'S PRINTED INSTALLATION INSTRUCTIONS (MPII)

1

HAS/HIT-V
HIS-N
Rebar

d_0 : $5/8" \dots 1 1/8"$
16 ... 32 mm

h_{ef} : $2 3/8" \dots 39 3/8"$
60 ... 1000 mm

TE-CD
TE-YD

6...12

	A	B	C
h_{ef}	$2 3/8" \dots 9 7/8"$ 60 ... 250 mm	$2 3/8" \dots 25"$ 60 ... 640 mm	$2 3/8" \dots 25"$ 60 ... 640 mm
	18	19	20 21

2

HIT-V
HAS
Rebar

d_0 : $7/16" \dots 1 1/2"$
10 ... 40 mm

h_{ef} : $2 3/8" \dots 25"$
60 ... 640 mm

6...10

2 $3k \rightarrow$ 6 bar/90 psi

3 $3k \rightarrow$ 6 bar/90 psi

4 $3k \rightarrow$ 6 bar/90 psi

	A	B	C
h_{ef}	$2 3/8" \dots 9 7/8"$ 60 ... 250 mm	$2 3/8" \dots 25"$ 60 ... 640 mm	$2 3/8" \dots 25"$ 60 ... 640 mm
	18	19	20 21

3

HIT-V
HAS
HIS-N
Rebar

d_0 : $7/16" \dots 3/4"$
10 ... 20 mm

h_{ef} : $2 3/8" \dots 10d$
60 mm ... 10d

6...10

2 $3k \rightarrow$ 6 bar/90 psi

3 $3k \rightarrow$ 6 bar/90 psi

4 $3k \rightarrow$ 6 bar/90 psi

	A	C
h_{ef}	$2 3/8" \dots 9 7/8"$ 60 ... 250 mm	$2 3/8" \dots 25"$ 60 ... 640 mm
	18	20 21

A

h_{ef} : $2 3/8" \dots 9 7/8"$
60 ... 250 mm

HAS/HIT-V
HIS-N
Rebar

HIT-RE-M \rightarrow 11...12

1

HDM 330
HDM 500
HDE 500-A18

2

330 ml: 2x
500 ml: 3x
 $T < 5^{\circ}C / 41^{\circ}F$: 4x

3

4

5

5.A

5.B

6

t_{work} 13

7

t_{cure} 13

T_{inst} / T_{max} 6 ... 8

B

h_{ef} : $2 3/8" \dots 25"$
60 ... 640 mm

HAS/HIT-V
Rebar

HIT-RE-M
HIT-SZ \rightarrow 11...12

1

HDM 330
HDM 500
HDE 500-A18

2

330 ml: 2x
500 ml: 3x
 $T < 5^{\circ}C / 41^{\circ}F$: 4x

3

4

5

5.A

5.B

6





t_{work} 13

7

t_{cure} 13

T_{max} 6 ... 8

FIGURE 4—MANUFACTURER'S PRINTED INSTALLATION INSTRUCTIONS (MPII) (Continued)

C		h _{ef} : 2 3/8" ... 25" 60...640 mm	HAS/HIT-V  HIS-N  Rebar 	HIT-RE-M  HIT-SZ  HIT-OHW  HIT-OHC 	
	11...12				

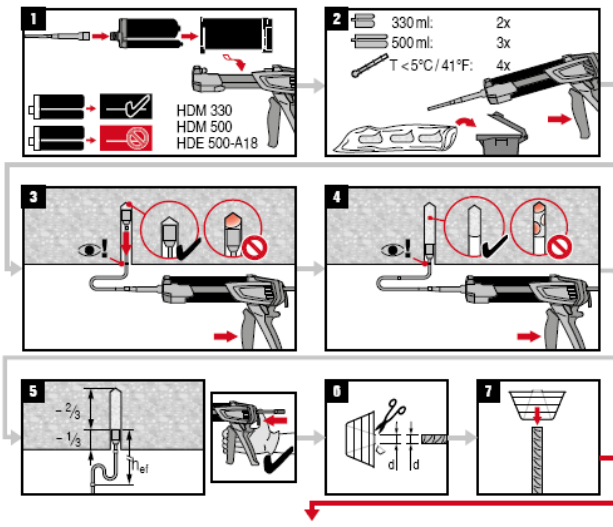
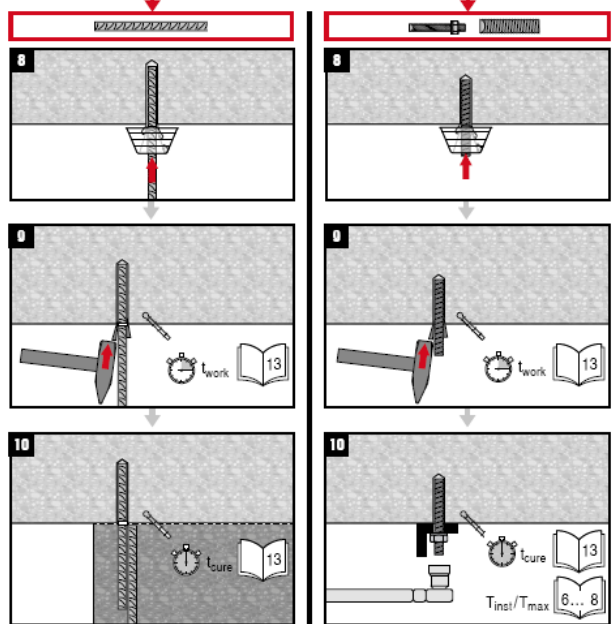
Hilti HIT-HY 100

Adhesive anchoring system for rebar and anchor fastenings in concrete.

Safety Instructions:

Contains: Hydroxypropyl methacrylate(A), boric acid (A), dibenzoyl peroxide(B)



Danger

- | | |
|----------------|--|
| H317 | May cause an allergic skin reaction. (A,B) |
| H319 | Causes serious eye irritation (A) |
| H360 | May damage fertility or the unborn child. (A) |
| H400 | Very toxic to aquatic life. (B) |
| P262 | Do not get in eyes, on skin, or on clothing. |
| P280 | Wear protective gloves/protective clothing/eye protection/face protection. |
| P302+P352 | IF ON SKIN: Wash with plenty of soap and water. |
| P305+P351+P338 | IF IN EYES: Rinse cautiously with water for several minutes. Remove contact lenses, if present and easy to do. Continue rinsing. |
| P333+P313 | If skin irritation or rash occurs: Get medical advice/attention. |
| P337+P313 | If eye irritation persists: Get medical advice/attention. |

Disposal considerations

Empty packs:

- Leave the mixer attached and dispose of via the local Green Dot recovery system 
- or EAK waste material code: 150102 plastic packaging

Full or partially emptied packs:

- Must be disposed of as special waste in accordance with official regulations.
- EAK waste material code: 08 04 09* waste adhesives and sealants containing organic solvents or other dangerous substances.
- or EAK waste material code: 20 01 27* paint, inks, adhesives and resins containing dangerous substances.

Content: 330 ml / 11.1 fl.oz. 500 ml / 16.9 fl.oz **Weight:** 575g / 20.3oz 880g / 31.0oz

Warranty: Refer to standard Hilti terms and conditions of sale for warranty information.

Failure to observe these installation instructions, use of non-Hilti anchors, poor or questionable base material conditions, or unique applications may affect the reliability or performance of the fastenings.

Product Information

- Always keep these instructions together with the product even when given to other persons.
- Review the MSDS before use.
- Check expiration date:** See imprint on foil pack manifold (month/year). Do not use expired product.
- Foil pack temperature during usage:** 0 °C to 40 °C / 32 °F to 104 °F.
- Base material temperature at time of installation:** between -10 °C and 40 °C / 14 °F and 104 °F.
- Conditions for transport and storage:** Keep in a cool, dry and dark place between 5 °C and 25 °C / 41 °F and 77 °F.
- For any application not covered by this document / beyond values specified, please contact Hilti.
- Partly used foil packs must remain in the cassette** and has to be used within **4 weeks**. Leave the mixer attached on the foil pack manifold and store within the cassette under the recommended storage conditions. If reused, attach a new mixer and discard the initial quantity of anchor adhesive.

NOTICE

Improper handling may cause mortar splashes.

- Always wear eye protection, gloves and protective clothes during installation.
- Never start dispensing without a mixer properly screwed on.
- Attach a new mixer prior to dispensing a new foil pack (ensure snug fit).
- Use only the type of mixer (HIT-RE-M) supplied with the adhesive. Do not modify the mixer in any way.
- Never use damaged foil packs and/or damaged or unclean foil pack holders (cassettes).

Poor load values / potential failure of fastening points due to inadequate borehole cleaning.

- Holes should be drilled with a rotary hammer drill, using drill bits that comply with ANSI B212.15-1984.
- The boreholes must be free of debris, dust, water, ice, oil, grease and other contaminants prior to adhesive injection.
- For blowing out the borehole – blow out with oil free air until return air stream is free of noticeable dust.
- For brushing the borehole – only use specified wire brush. The brush must resist insertion into the borehole – if not the brush is too small and must be replaced.
- Before inserting anchor/rebar into borehole, mark and set anchor/rebar to the required embedment depth.
- Anchor rods/rebar shall be free of dirt, grease, oil, and other contaminants.

Ensure that boreholes are filled from the back of the borehole without forming air voids.

- The annular gap between the anchor/rebar and the borehole shall be filled completely with no gaps.
- If necessary use the accessories / extensions to reach the back of the borehole.
- For overhead applications use the overhead accessories HIT-SZ and take special care when inserting the fastening element. Excess adhesive may be forced out of the borehole. Make sure that no mortar drips onto the installer.

Not adhering to these setting instructions can result in failure of fastening points!

FIGURE 4—MANUFACTURER'S PRINTED INSTALLATION INSTRUCTIONS (MPII) (Continued)

DIVISION: 03 00 00—CONCRETE

Section: 03 16 00—Concrete Anchors

DIVISION: 05 00 00—METALS

Section: 05 05 19—Post-Installed Concrete Anchors

REPORT HOLDER:

HILTI, INC.

EVALUATION SUBJECT:

HILTI HIT-HY 100 ADHESIVE ANCHORING SYSTEM IN CRACKED AND UNCRACKED CONCRETE

1.0 REPORT PURPOSE AND SCOPE

Purpose:

The purpose of this evaluation report supplement is to indicate that the Hilti HIT HY 100 Adhesive Anchoring System for cracked and uncracked concrete, described in ICC-ES evaluation report [ESR-3574](#), has also been evaluated for compliance with the codes noted below as adopted by the Los Angeles Department of Building and Safety (LADBS).

Applicable code editions:

- 2023 *City of Los Angeles Building Code* (LABC)
- 2023 *City of Los Angeles Residential Code* (LARC)

2.0 CONCLUSIONS

The Hilti HIT-HY 100 Adhesive Anchoring System for cracked and uncracked concrete, described in Sections 2.0 through 7.0 of the evaluation report [ESR-3574](#), complies with LABC Chapter 19, and LARC, and is subjected to the conditions of use described in this supplement.

3.0 CONDITIONS OF USE

The Hilti HIT HY 100 Adhesive Anchoring System described in this evaluation report supplement must comply with all of the following conditions:

- All applicable sections in the evaluation report [ESR-3574](#).
- The design, installation, conditions of use and labeling of the Hilti HIT-HY 100 Adhesive Anchoring System are in accordance with the 2021 *International Building Code*® (IBC) provisions noted in the evaluation report [ESR-3574](#).
- The design, installation and inspection are in accordance with additional requirements of LABC Chapters 16 and 17, as applicable.
- Under the LARC, an engineered design in accordance with LARC Section R301.1.3 must be submitted.
- The allowable and strength design values listed in the evaluation report and tables are for the connection of the adhesive anchors to the concrete. The connection between the adhesive anchors and the connected members shall be checked for capacity (which may govern).
- For use in wall anchorage assemblies to flexible diaphragm, anchors shall be designed per the requirements of City of Los Angeles Information Bulletin P/BC 2020-071.

This supplement expires concurrently with the report, reissued August 2024.

DIVISION: 03 00 00—CONCRETE

Section: 03 16 00—Concrete Anchors

DIVISION: 05 00 00—METALS

Section: 05 05 19—Post-Installed Concrete Anchors

REPORT HOLDER:

HILTI, INC.

EVALUATION SUBJECT:

HILTI HIT-HY 100 ADHESIVE ANCHORING SYSTEM IN CRACKED AND UNCRACKED CONCRETE

1.0 REPORT PURPOSE AND SCOPE

Purpose:

The purpose of this evaluation report supplement is to indicate that the Hilti HIT-HY 100 Adhesive Anchor System in Uncracked Concrete, described in ICC-ES evaluation report ESR-3574, has also been evaluated for compliance with the codes noted below.

Applicable code editions:

- 2023 Florida Building Code—Building
- 2023 Florida Building Code—Residential

2.0 CONCLUSIONS

The Hilti HIT-HY 100 Adhesive Anchor System in Uncracked Concrete, described in Sections 2.0 through 7.0 of the ICC-ES evaluation report ESR-3574, complies with the *Florida Building Code—Building* and the *Florida Building Code—Residential*, provided the design requirements are determined in accordance with the *Florida Building Code—Building* or the *Florida Building Code—Residential*, as applicable. The installation requirements noted in ICC-ES evaluation report ESR-3574 for the 2021 *International Building Code*® meet the requirements of the *Florida Building Code—Building* or the *Florida Building Code—Residential*, as applicable.

Use of the Hilti HIT-HY 100 Adhesive Anchor System in Cracked and Uncracked Concrete has also been found to be in compliance with the High-Velocity Hurricane Zone provisions of the *Florida Building Code—Building* and the *Florida Building Code—Residential* with the following condition.

- a) For anchorage of wood members, the connection subject to uplift must be designed for no less than 700 pounds (3114 N).

For products falling under Florida Rule 61G20-3, verification that the report holder's quality-assurance program is audited by a quality-assurance entity approved by the Florida Building Commission for the type of inspections being conducted is the responsibility of an approved validation entity (or the code official, when the report holder does not possess an approval by the Commission).

This supplement expires concurrently with the evaluation report, reissued August 2024.