



EVERYDAY SOLUTION FOR FAST-CURE CHEMICAL ANCHORING

HIT-HY 100 Adhesive Anchor



EVERYDAY SOLUTION FOR FAST-CURE CHEMICAL ANCHORING

Hybrid Adhesive HIT-HY 100

Hilti HIT-HY 100 is the everyday fast-cure mortar that provides the quality you've come to expect from Hilti at an economical price. HIT-HY 100 has approvals for cracked and un-cracked concrete and grout filled CMU, making HIT-HY 100 more versatile for rebar doweling and anchoring.

Take reliability, safety, and productivity to a new level with HIT-HY 100 and SafeSet technology by eliminating the manual hole cleaning step. With the TE-CD and TE-YD hollow bits and the VC 150 and VC 300 series vacuums, you can increase productivity up to 60% while achieving correct hole preparation and OSHA 1926.1153 Table 1 compliance.



APPLICATIONS AND ADVANTAGES

- Suitable for use in un-cracked concrete and cracked concrete with all anchor rods and rebar per ICC-ES approval (International Code Council — Evaluation Service)
- Suitable for use in grout-filled CMU for anchor rods per IAPMO-UES (IAPMO-UES (International Association of Plumbing and Mechanical Officials Uniform Evaluation Service))
- Anchoring light structural steel connections (e.g. steel columns, beams)
- Rebar doweling / connection of secondary post-installed rebar
- Easy and accurate dispensing with HDE 500-A22 battery dispenser
- SafeSet technology — automatic hole cleaning with TE-CD / TE-YD hollow drill bits and VC 150/300 vacuum



2015 IBC®
Compliant Anchor



Technical data

| | |
|----------------------------------|--|
| Product | Hybrid Urethane Methacrylate |
| Base material temperature | 14° F to 104° F (-10° C to 40° C) |
| Diameter range | 3/8" to 1-1/4" |
| Package volume | <ul style="list-style-type: none"> • Volume of HIT-HY 100 11.1 fl oz/330 ml foil pack is 20.1 in³ • Volume of HIT-HY 100 16.9 fl oz/500 ml foil pack is 30.5 in³ |





| Description | Qty of foil packs | Item number |
|--|-------------------|-------------|
| HIT-HY 100 (11.1oz/330ml) | 1 | 2078494 |
| HIT-HY 100 Master Carton (11.1oz/330ml) | 25 | 3510989 |
| HIT-HY 100 Master Carton (11.1oz/330ml) + HDM 500 | 25 | 3510991 |
| HIT-HY 100 Master Carton (16.9oz/500ml) | 20 | 2078495 |
| (2) HIT-HY 100 Master Cartons (16.9oz/500ml) + HDM 500 | 40 | 3511063 |
| (2) HIT-HY 100 Master Cartons (16.9oz/500ml) + HDE 500 Kit | 40 | 3511064 |
| HY 100 TE 50 AVR SafeSet Pack | 40 | 3582040 |

Accessories

| Description | Item number |
|-----------------------------|-------------|
| HDM 500 Manual Dispenser | 3498241 |
| HDE 500-A22 Starter Package | 3540270 |

PRODUCT DESCRIPTION

HIT-HY 100 with Threaded Rod, Rebar, and HIS-N/RN Inserts

| Mortar system | Features and Benefits |
|---|--|
|  <p>Hilti HIT-HY 100 Cartridge</p>  <p>Threaded Rod HAS HIT-V</p>  <p>Rebar</p>  <p>Hilti HIS-N</p> | <ul style="list-style-type: none"> • No additional hole cleaning required after drilling when installed SafeSet™ hollow drill bit technology • ICC-ES approved for cracked concrete and seismic service • IAPMO approved for grout-filled concrete masonry • Anchoring light structural steel connections (e.g. steel columns, beams) • Anchoring secondary steel elements • Rebar doweling and connecting secondary post-installed rebar • Complete anchor system available, including HAS rods, HIT-V rods and HIS-N inserts • Easy and accurate dispensing with battery dispenser |

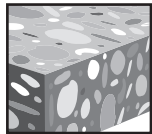

Uncracked concrete

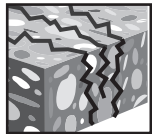

Cracked concrete

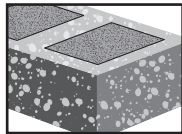

Grout-filled concrete masonry

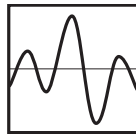

Seismic Design Categories A-F



SafeSet System with Hollow Drill Bit



PROFIS Anchor design software

Approvals/Listings

| | |
|---|---|
| ICC-ES (International Code Council Evaluation Service) | ESR-3574 (for concrete) |
| IAPMO-UES (International Association of Plumbing and Mechanical Officials Uniform Evaluation Service) | ER-547 (for grout-filled CMU) |
| NSF/ANSI Std 61 | Certification for use in potable water |
| City of Los Angeles | LABC Supplement in ESR-3574 |
| U.S. Green Building Council | LEED® Credit 4.1-Low Emitting Materials |
| Department of Transportation | Contact Hilti for various states |



DESIGN DATA IN CONCRETE PER ACI 318

ACI 318-14 Chapter 17 design

The technical data contained in this section are Hilti Simplified Design Tables. The load values were developed using the Strength Design parameters developed through testing per ACI 355.4 and the equations within ACI 318-14 Chapter 17. For a detailed explanation of the Hilti Simplified Design Tables, refer to of the Hilti North American Product Technical Guide, Volume 2: Anchor Fastening Technical Guide, Edition 17.

For additional information or technical assistance, contact Hilti at 800-879-5000 (US) or 800-363-4459 (CA)

Hilti HIT-HY 100 Adhesive with Deformed Reinforcing Bars (Rebar)



Rebar installation conditions

| | | | | | | | |
|----------------------------|--|--------------------|--|--------------------------|-----------------------------|--|---|
| Permissible Base Materials | | Uncracked concrete | | Dry Concrete | Permissible Drilling Method | | Hammer Drilling with Carbide Tipped Drill Bit |
| | | Cracked concrete | | Water Saturated Concrete | | | Hollow Drill Bit |

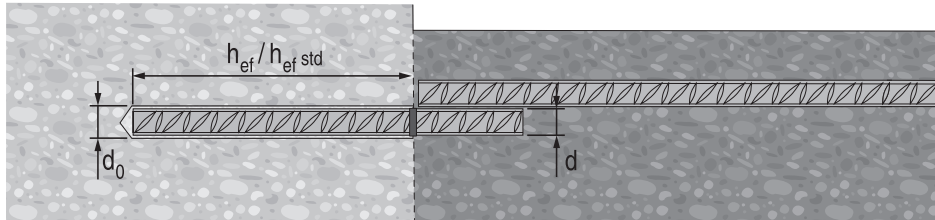

US rebar installation specifications

| Rebar Size | Drill Bit Dia. | Standard Embed. Depth | Embed. Depth Range | Minimum Base Material Thickness |
|------------|----------------|-----------------------|----------------------------|---------------------------------------|
| | d_0 in | $h_{ef\ std}$ in (mm) | h_{ef} in (mm) | h_{min} in (mm) |
| #3 | 1/2 | 3-3/8 (86) | 2-3/8 - 7-1/2 (60 - 191) | $h_{ef} + 1-1/4$ ($h_{ef} + 30$) |
| #4 | 5/8 | 4-1/2 (114) | 2-3/4 - 10 (70 - 254) | |
| #5 | 3/4 | 5-5/8 (143) | 3-1/8 - 12-1/2 (79 - 318) | |
| #6 | 7/8 | 6-3/4 (171) | 3-1/2 - 15 (89 - 381) | $h_{ef} + 2d_0$ |
| #7 | 1 | 7-7/8 (200) | 3-1/2 - 17-1/2 (89 - 445) | |
| #8 | 1-1/8 | 9 (229) | 4 - 20 (102 - 508) | |
| #9 | 1-3/8 | 10-1/8 (257) | 4-1/2 - 22-1/2 (114 - 572) | |
| #10 | 1-1/2 | 11-1/4 (286) | 5 - 25 (127 - 635) | |

Canadian rebar installation specifications

| Rebar Size | Drill Bit Dia. | Standard Embed. Depth | Embed. Depth Range | Minimum Base Material Thickness |
|------------|----------------|-----------------------|--------------------|--------------------------------------|
| | d_0 in | $h_{ef\ std}$ mm | h_{ef} mm | h_{min} mm |
| 10 M | 9/16 | 115 | 70 - 226 | $h_{ef} + 30$ $h_{ef} + 2d_0$ |
| 15 M | 3/4 | 145 | 80 - 320 | |
| 20 M | 1 | 200 | 90 - 390 | |
| 25 M | 1-1/4 | 230 | 101 - 504 | |
| 30 M | 1-1/2 | 260 | 120 - 598 | |

Table 1 – Hilti HIT-HY 100 adhesive design strength with concrete / bond failure for US rebar in uncracked concrete 1,2,3,4,5,6,7,8

| Rebar size | Effective embedment in. (mm) | Tension – ϕN_n | | | | Shear – ϕV_n | | | |
|------------|------------------------------|--|--|--|--|--|--|--|--|
| | | $f'_c = 2500$ psi (17.2 Mpa) lb (kN) | $f'_c = 3000$ psi (20.7 Mpa) lb (kN) | $f'_c = 4000$ psi (27.6 Mpa) lb (kN) | $f'_c = 6000$ psi (41.4 Mpa) lb (kN) | $f'_c = 2500$ psi (17.2 Mpa) lb (kN) | $f'_c = 3000$ psi (20.7 Mpa) lb (kN) | $f'_c = 4000$ psi (27.6 Mpa) lb (kN) | $f'_c = 6000$ psi (41.4 Mpa) lb (kN) |
| #3 | 3-3/8 (86) | 3,295 (14.7) | 3,355 (14.9) | 3,455 (15.4) | 3,595 (16.0) | 7,095 (31.6) | 7,230 (32.2) | 7,440 (33.1) | 7,745 (34.5) |
| | 4-1/2 (114) | 4,395 (19.5) | 4,475 (19.9) | 4,605 (20.5) | 4,795 (21.3) | 9,465 (42.1) | 9,635 (42.9) | 9,920 (44.1) | 10,330 (45.9) |
| | 7-1/2 (191) | 7,325 (32.6) | 7,455 (33.2) | 7,675 (34.1) | 7,995 (35.6) | 15,770 (70.1) | 16,060 (71.4) | 16,530 (73.5) | 17,215 (76.6) |
| #4 | 4-1/2 (114) | 5,810 (25.8) | 5,920 (26.3) | 6,090 (27.1) | 6,345 (28.2) | 12,520 (55.7) | 12,750 (56.7) | 13,120 (58.4) | 13,665 (60.8) |
| | 6 (152) | 7,750 (34.5) | 7,890 (35.1) | 8,120 (36.1) | 8,460 (37.6) | 16,690 (74.2) | 17,000 (75.6) | 17,495 (77.8) | 18,220 (81.0) |
| | 10 (254) | 12,915 (57.4) | 13,155 (58.5) | 13,535 (60.2) | 14,100 (62.7) | 27,820 (123.7) | 28,330 (126.0) | 29,160 (129.7) | 30,365 (135.1) |
| #5 | 5-5/8 (143) | 8,995 (40.0) | 9,160 (40.7) | 9,430 (41.9) | 9,820 (43.7) | 19,375 (86.2) | 19,730 (87.8) | 20,305 (90.3) | 21,145 (94.1) |
| | 7-1/2 (191) | 11,995 (53.4) | 12,215 (54.3) | 12,570 (55.9) | 13,090 (58.2) | 25,835 (114.9) | 26,310 (117.0) | 27,075 (120.4) | 28,195 (125.4) |
| | 12-1/2 (318) | 19,990 (88.9) | 20,355 (90.5) | 20,950 (93.2) | 21,820 (97.1) | 43,055 (191.5) | 43,845 (195.0) | 45,125 (200.7) | 46,995 (209.0) |
| #6 | 6-3/4 (171) | 12,820 (57.0) | 13,055 (58.1) | 13,435 (59.8) | 13,990 (62.2) | 27,610 (122.8) | 28,120 (125.1) | 28,940 (128.7) | 30,135 (134.0) |
| | 9 (229) | 17,090 (76.0) | 17,405 (77.4) | 17,915 (79.7) | 18,655 (83.0) | 36,815 (163.8) | 37,490 (166.8) | 38,585 (171.6) | 40,180 (178.7) |
| | 15 (381) | 28,485 (126.7) | 29,010 (129.0) | 29,855 (132.8) | 31,095 (138.3) | 61,355 (272.9) | 62,485 (277.9) | 64,310 (286.1) | 66,970 (297.9) |
| #7 | 7-7/8 (200) | 17,235 (76.7) | 17,625 (78.4) | 18,140 (80.7) | 18,890 (84.0) | 37,125 (165.1) | 37,965 (168.9) | 39,070 (173.8) | 40,690 (181.0) |
| | 10-1/2 (267) | 23,075 (102.6) | 23,500 (104.5) | 24,185 (107.6) | 25,190 (112.1) | 49,705 (221.1) | 50,615 (225.1) | 52,095 (231.7) | 54,250 (241.3) |
| | 17-1/2 (445) | 38,460 (171.1) | 39,170 (174.2) | 40,310 (179.3) | 41,980 (186.7) | 82,840 (368.5) | 84,360 (375.3) | 86,825 (386.2) | 90,415 (402.2) |
| #8 | 9 (229) | 21,060 (93.7) | 22,835 (101.6) | 23,500 (104.5) | 24,475 (108.9) | 45,360 (201.8) | 49,180 (218.8) | 50,615 (225.1) | 52,710 (234.5) |
| | 12 (305) | 29,895 (133.0) | 30,445 (135.4) | 31,335 (139.4) | 32,630 (145.1) | 64,390 (286.4) | 65,575 (291.7) | 67,490 (300.2) | 70,280 (312.6) |
| | 20 (508) | 49,825 (221.6) | 50,740 (225.7) | 52,225 (232.3) | 54,385 (241.9) | 107,315 (477.4) | 109,290 (486.1) | 112,480 (500.3) | 117,135 (521.0) |
| #9 | 10-1/8 (257) | 22,635 (100.7) | 23,050 (102.5) | 23,725 (105.5) | 24,705 (109.9) | 54,125 (240.8) | 58,675 (261.0) | 60,385 (268.6) | 62,885 (279.7) |
| | 13-1/2 (343) | 30,180 (134.2) | 30,735 (136.7) | 31,630 (140.7) | 32,940 (146.5) | 76,820 (341.7) | 78,230 (348.0) | 80,515 (358.1) | 83,845 (373.0) |
| | 22-1/2 (572) | 50,295 (223.7) | 51,225 (227.9) | 52,720 (234.5) | 54,900 (244.2) | 128,030 (569.5) | 130,385 (580.0) | 134,190 (596.9) | 139,745 (621.6) |
| #10 | 11-1/4 (286) | 25,025 (111.3) | 25,490 (113.4) | 26,230 (116.7) | 27,315 (121.5) | 63,395 (282.0) | 64,880 (288.6) | 66,770 (297.0) | 69,535 (309.3) |
| | 15 (381) | 33,370 (148.4) | 33,985 (151.2) | 34,975 (155.6) | 36,425 (162.0) | 84,940 (377.8) | 86,505 (384.8) | 89,030 (396.0) | 92,710 (412.4) |
| | 25 (635) | 55,615 (247.4) | 56,640 (251.9) | 58,290 (259.3) | 60,705 (270.0) | 141,570 (629.7) | 144,175 (641.3) | 148,380 (660.0) | 154,520 (687.3) |

1 See Section 3.1.8 (2017 PTG) for explanation on development of load values.
 2 See Section 3.1.8.6 (2017 PTG) to convert design strength value to ASD value.
 3 Linear interpolation between embedment depths and concrete compressive strengths is not permitted.
 4 Load values are for a single anchor with no spacing, edge distance, or concrete thickness factors. Apply spacing, edge distance, and concrete thickness factors in tables 4-19 as necessary. Compare to the steel values in table 3. The lesser of the values is to be used for the design.
 5 Data is for temperature range A: Max. short term temperature = 130°F (55°C), max. long term temperature = 110°F (43°C).
 For temperature range B: Max. short term temperature = 176°F (80°C), max. long term temperature = 110°F (43°C) multiply above value by 0.92.
 For temperature range C: Max. short term temperature = 210°F (99°C), max. long term temperature = 162°F (72°C) multiply above value by 0.71.
 Short term elevated concrete temperatures are those that occur over brief intervals, e.g., as a result of diurnal cycling. Long term concrete temperatures are roughly constant over significant periods of time.
 6 Tabular values are for dry concrete conditions. For water saturated concrete multiply design strength (factored resistance) by 0.85.
 7 Tabular values are for short term loads only. For sustained loads including overhead use, see Section 3.1.8.8 (2017 PTG).
 8 Tabular values are for normal-weight concrete only. For lightweight concrete multiply design strength by λ_n as follows:
 For sand-lightweight, $\lambda_n = 0.51$. For all-lightweight, $\lambda_n = 0.45$.

Table 2 — Hilti HIT-HY 100 adhesive design strength with concrete / bond failure for US rebar in cracked concrete 1,2,3,4,5,6,7,8

| Rebar size | Effective embedment in. (mm) | Tension — ϕN_n | | | | Shear — ϕV_n | | | |
|------------|------------------------------|--|--|--|--|--|--|--|--|
| | | $f'_c = 2500$ psi (17.2 Mpa) lb (kN) | $f'_c = 3000$ psi (20.7 Mpa) lb (kN) | $f'_c = 4000$ psi (27.6 Mpa) lb (kN) | $f'_c = 6000$ psi (41.4 Mpa) lb (kN) | $f'_c = 2500$ psi (17.2 Mpa) lb (kN) | $f'_c = 3000$ psi (20.7 Mpa) lb (kN) | $f'_c = 4000$ psi (27.6 Mpa) lb (kN) | $f'_c = 6000$ psi (41.4 Mpa) lb (kN) |
| #3 | 3-3/8 (86) | 1,575 (7.0) | 1,605 (7.1) | 1,650 (7.3) | 1,720 (7.7) | 3,395 (15.1) | 3,460 (15.4) | 3,560 (15.8) | 3,705 (16.5) |
| | 4-1/2 (114) | 2,100 (9.3) | 2,140 (9.5) | 2,205 (9.8) | 2,295 (10.2) | 4,525 (20.1) | 4,610 (20.5) | 4,745 (21.1) | 4,940 (22.0) |
| | 7-1/2 (191) | 3,505 (15.6) | 3,570 (15.9) | 3,670 (16.3) | 3,825 (17.0) | 7,545 (33.6) | 7,685 (34.2) | 7,910 (35.2) | 8,235 (36.6) |
| #4 | 4-1/2 (114) | 3,080 (13.7) | 3,135 (13.9) | 3,225 (14.3) | 3,360 (14.9) | 6,630 (29.5) | 6,750 (30.0) | 6,950 (30.9) | 7,235 (32.2) |
| | 6 (152) | 4,105 (18.3) | 4,180 (18.6) | 4,300 (19.1) | 4,480 (19.9) | 8,840 (39.3) | 9,005 (40.1) | 9,265 (41.2) | 9,650 (42.9) |
| | 10 (254) | 6,840 (30.4) | 6,965 (31.0) | 7,170 (31.9) | 7,465 (33.2) | 14,735 (65.5) | 15,005 (66.7) | 15,445 (68.7) | 16,080 (71.5) |
| #5 | 5-5/8 (143) | 5,205 (23.2) | 5,300 (23.6) | 5,455 (24.3) | 5,680 (25.3) | 11,210 (49.9) | 11,415 (50.8) | 11,750 (52.3) | 12,235 (54.4) |
| | 7-1/2 (191) | 6,940 (30.9) | 7,065 (31.4) | 7,275 (32.4) | 7,575 (33.7) | 14,945 (66.5) | 15,220 (67.7) | 15,665 (69.7) | 16,315 (72.6) |
| | 12-1/2 (318) | 11,565 (51.4) | 11,780 (52.4) | 12,125 (53.9) | 12,625 (56.2) | 24,910 (110.8) | 25,370 (112.9) | 26,110 (116.1) | 27,190 (120.9) |
| #6 | 6-3/4 (171) | 8,010 (35.6) | 8,160 (36.3) | 8,395 (37.3) | 8,745 (38.9) | 17,255 (76.8) | 17,575 (78.2) | 18,085 (80.4) | 18,835 (83.8) |
| | 9 (229) | 10,680 (47.5) | 10,880 (48.4) | 11,195 (49.8) | 11,660 (51.9) | 23,010 (102.4) | 23,430 (104.2) | 24,115 (107.3) | 25,115 (111.7) |
| | 15 (381) | 17,805 (79.2) | 18,130 (80.6) | 18,660 (83.0) | 19,435 (86.5) | 38,345 (170.6) | 39,055 (173.7) | 40,190 (178.8) | 41,855 (186.2) |
| #7 | 7-7/8 (200) | 10,975 (48.8) | 11,175 (49.7) | 11,505 (51.2) | 11,980 (53.3) | 23,640 (105.2) | 24,075 (107.1) | 24,775 (110.2) | 25,800 (114.8) |
| | 10-1/2 (267) | 14,635 (65.1) | 14,905 (66.3) | 15,340 (68.2) | 15,975 (71.1) | 31,520 (140.2) | 32,100 (142.8) | 33,035 (146.9) | 34,405 (153.0) |
| | 17-1/2 (445) | 24,390 (108.5) | 24,840 (110.5) | 25,565 (113.7) | 26,620 (118.4) | 52,530 (233.7) | 53,500 (238.0) | 55,060 (244.9) | 57,340 (255.1) |
| #8 | 9 (229) | 14,520 (64.6) | 14,785 (65.8) | 15,220 (67.7) | 15,845 (70.5) | 31,270 (139.1) | 31,845 (141.7) | 32,775 (145.8) | 34,135 (151.8) |
| | 12 (305) | 19,360 (86.1) | 19,715 (87.7) | 20,290 (90.3) | 21,130 (94.0) | 41,695 (185.5) | 42,460 (188.9) | 43,700 (194.4) | 45,510 (202.4) |
| | 20 (508) | 32,265 (143.5) | 32,860 (146.2) | 33,815 (150.4) | 35,215 (156.6) | 69,490 (309.1) | 70,770 (314.8) | 72,835 (324.0) | 75,850 (337.4) |
| #9 | 10-1/8 (257) | 15,645 (69.6) | 15,935 (70.9) | 16,400 (73.0) | 17,080 (76.0) | 38,340 (170.5) | 40,560 (180.4) | 41,745 (185.7) | 43,470 (193.4) |
| | 13-1/2 (343) | 20,860 (92.8) | 21,245 (94.5) | 21,865 (97.3) | 22,770 (101.3) | 53,105 (236.2) | 54,080 (240.6) | 55,660 (247.6) | 57,965 (257.8) |
| | 22-1/2 (572) | 34,770 (154.7) | 35,410 (157.5) | 36,445 (162.1) | 37,950 (168.8) | 88,510 (393.7) | 90,135 (400.9) | 92,765 (412.6) | 96,605 (429.7) |
| #10 | 11-1/4 (286) | 19,560 (87.0) | 19,920 (88.6) | 20,500 (91.2) | 21,350 (95.0) | 44,905 (199.7) | 49,190 (218.8) | 52,185 (232.1) | 54,345 (241.7) |
| | 15 (381) | 26,080 (116.0) | 26,560 (118.1) | 27,335 (121.6) | 28,465 (126.6) | 66,385 (295.3) | 67,605 (300.7) | 69,580 (309.5) | 72,460 (322.3) |
| | 25 (635) | 43,465 (192.1) | 44,265 (195.7) | 45,560 (201.4) | 47,445 (209.7) | 110,645 (489.1) | 112,680 (498.1) | 115,965 (512.6) | 120,765 (533.9) |

1 See Section 3.1.8 (2017 PTG) for explanation on development of load values.

2 See Section 3.1.8.6 (2017 PTG) to convert design strength value to ASD value.

3 Linear interpolation between embedment depths and concrete compressive strengths is not permitted.

4 Load values are for a single anchor with no spacing, edge distance, or concrete thickness factors. Apply spacing, edge distance, and concrete thickness factors in tables 4-19 as necessary. Compare to the steel values in table 3. The lesser of the values is to be used for the design.

5 Data is for temperature range A: Max. short term temperature = 104°F (40°C), max. long term temperature = 75°F (24°C).

For temperature range B: Max. short term temperature = 176°F (80°C), max. long term temperature = 110°F (43°C) multiply above value by 0.92.

For temperature range C: Max. short term temperature = 210°F (99°C), max. long term temperature = 162°F (72°C) multiply above value by 0.71.

Short term elevated concrete temperatures are those that occur over brief intervals, e.g., as a result of diurnal cycling. Long term concrete temperatures are roughly constant over significant periods of time.

6 Tabular values are for dry concrete conditions. For water saturated concrete multiply design strength (factored resistance) by 0.85.

7 Tabular values are for short term loads only. For sustained loads including overhead use, see Section 3.1.8.8 (2017 PTG).

8 Tabular values are for normal-weight concrete only. For lightweight concrete multiply design strength by λ_a as follows:

For sand-lightweight, $\lambda_a = 0.51$. For all-lightweight, $\lambda_a = 0.45$.

9 Tabular values are for static loads only. For seismic loads, multiply cracked concrete tabular values in tension and shear by $\alpha_{\text{seis}} = 0.75$

See section 3.1.8.7 (2017 PTG) for additional information on seismic applications.

Table 3 — Steel design strength for US rebar ^{1,2}

| Rebar size | ASTM A 615 Grade 40 | | | ASTM A 615 Grade 60 | | | ASTM A 706 Grade 60 | | |
|------------|--|--|---|--|--|---|--|--|---|
| | Tensile ³ ϕN_{sa} lb (kN) | Shear ⁴ ϕV_{sa} lb (kN) | Seismic Shear ⁵ $\phi V_{sa,eq}$ lb (kN) | Tensile ³ ϕN_{sa} lb (kN) | Shear ⁴ ϕV_{sa} lb (kN) | Seismic Shear ⁵ $\phi V_{sa,eq}$ lb (kN) | Tensile ³ ϕN_{sa} lb (kN) | Shear ⁴ ϕV_{sa} lb (kN) | Seismic Shear ⁵ $\phi V_{sa,eq}$ lb (kN) |
| #3 | 4,290 (19.1) | 2,375 (10.6) | 1,665 (7.4) | 6,435 (28.6) | 3,565 (15.9) | 2,495 (11.1) | 6,600 (29.4) | 3,430 (15.3) | 2,400 (10.7) |
| #4 | 7,800 (34.7) | 4,320 (19.2) | 3,025 (13.5) | 11,700 (52.0) | 6,480 (28.8) | 4,535 (20.2) | 12,000 (53.4) | 6,240 (27.8) | 4,370 (19.4) |
| #5 | 12,090 (53.8) | 6,695 (29.8) | 4,685 (20.8) | 18,135 (80.7) | 10,045 (44.7) | 7,030 (31.3) | 18,600 (82.7) | 9,670 (43.0) | 6,770 (30.1) |
| #6 | 17,160 (76.3) | 9,505 (42.3) | 6,655 (29.6) | 25,740 (114.5) | 14,255 (63.4) | 9,980 (44.4) | 26,400 (117.4) | 13,730 (61.1) | 9,610 (42.7) |
| #7 | 23,400 (104.1) | 12,960 (57.6) | 9,070 (40.3) | 35,100 (156.1) | 19,440 (86.5) | 13,610 (60.5) | 36,000 (160.1) | 18,720 (83.3) | 13,105 (58.3) |
| #8 | 30,810 (137.0) | 17,065 (75.9) | 11,945 (53.1) | 46,215 (205.6) | 25,595 (113.9) | 17,915 (79.7) | 47,400 (210.8) | 24,650 (109.6) | 17,255 (76.8) |
| #9 | 39,000 (173.5) | 21,600 (96.1) | 15,120 (67.3) | 58,500 (260.2) | 32,400 (144.1) | 22,680 (100.9) | 60,000 (266.9) | 31,200 (138.8) | 21,840 (97.1) |
| #10 | 49,530 (220.3) | 27,430 (122.0) | 19,200 (85.4) | 74,295 (330.5) | 41,150 (183.0) | 28,805 (128.1) | 76,200 (339.0) | 39,625 (176.3) | 27,740 (123.4) |

1 See Section 3.1.8.6 (2017 PTG) to convert design strength value to ASD value.
 2 ASTM A706 Grade 60 rebar are considered ductile steel elements. ASTM A 615 Grade 40 and 60 rebar are considered brittle steel elements.
 3 Tensile = $\phi A_{sa,N} f_{uts}$ as noted in ACI 318 Chapter 17
 4 Shear = $\phi 0.60 A_{sa,N} f_{uts}$ as noted in ACI 318 Chapter 17
 5 Seismic Shear = $\alpha_{V,seis} \phi V_{sa}$: Reduction for seismic shear only. See section 3.1.8.7 (2017 PTG) for additional information on seismic applications.

Table 4 – Load adjustment factors for #3 rebar in uncracked concrete ^{1,2,3}

| | #3 Uncracked concrete | Spacing factor in tension f_{AN} | | | Edge distance factor in tension f_{RN} | | | Spacing factor in shear ⁴ f_{AV} | | | Edge distance in shear | | | | | | Concrete thickness factor in shear ⁵ f_{HV} | | |
|---|--------------------------|--|---------------|----------------|--|---------------|----------------|---|---------------|----------------|------------------------------|---------------|----------------|--------------------------|---------------|----------------|--|---------------|----------------|
| | | | | | | | | | | | ⊥ Toward edge f_{RV} | | | ∥ To edge f_{RV} | | | | | |
| | | Embedment h_{ef} in (mm) | 3-3/8 (86) | 4-1/2 (114) | 7-1/2 (191) | 3-3/8 (86) | 4-1/2 (114) | 7-1/2 (191) | 3-3/8 (86) | 4-1/2 (114) | 7-1/2 (191) | 3-3/8 (86) | 4-1/2 (114) | 7-1/2 (191) | 3-3/8 (86) | 4-1/2 (114) | 7-1/2 (191) | 3-3/8 (86) | 4-1/2 (114) |
| Spacing (s) / edge distance (c_a) / concrete thickness (h), - in (mm) | 1-3/4 (44) | n/a | n/a | n/a | 0.32 | 0.23 | 0.13 | n/a | n/a | n/a | 0.10 | 0.08 | 0.05 | 0.21 | 0.16 | 0.09 | n/a | n/a | n/a |
| | 1-7/8 (48) | 0.59 | 0.57 | 0.54 | 0.33 | 0.24 | 0.14 | 0.54 | 0.53 | 0.52 | 0.12 | 0.09 | 0.05 | 0.23 | 0.17 | 0.10 | n/a | n/a | n/a |
| | 2 (51) | 0.60 | 0.57 | 0.54 | 0.34 | 0.25 | 0.14 | 0.54 | 0.53 | 0.52 | 0.13 | 0.10 | 0.06 | 0.25 | 0.19 | 0.11 | n/a | n/a | n/a |
| | 3 (76) | 0.65 | 0.61 | 0.57 | 0.42 | 0.31 | 0.18 | 0.56 | 0.55 | 0.54 | 0.23 | 0.17 | 0.10 | 0.42 | 0.31 | 0.18 | n/a | n/a | n/a |
| | 4 (102) | 0.70 | 0.65 | 0.59 | 0.52 | 0.38 | 0.22 | 0.58 | 0.57 | 0.55 | 0.36 | 0.27 | 0.16 | 0.52 | 0.38 | 0.22 | n/a | n/a | n/a |
| | 4-5/8 (117) | 0.73 | 0.67 | 0.60 | 0.60 | 0.43 | 0.25 | 0.60 | 0.58 | 0.56 | 0.45 | 0.33 | 0.20 | 0.60 | 0.43 | 0.25 | 0.62 | n/a | n/a |
| | 5 (127) | 0.75 | 0.69 | 0.61 | 0.64 | 0.47 | 0.27 | 0.61 | 0.59 | 0.56 | 0.50 | 0.38 | 0.23 | 0.64 | 0.47 | 0.27 | 0.65 | n/a | n/a |
| | 5-3/4 (146) | 0.78 | 0.71 | 0.63 | 0.74 | 0.54 | 0.31 | 0.62 | 0.60 | 0.57 | 0.62 | 0.46 | 0.28 | 0.74 | 0.54 | 0.31 | 0.70 | 0.63 | n/a |
| | 6 (152) | 0.80 | 0.72 | 0.63 | 0.77 | 0.56 | 0.33 | 0.63 | 0.60 | 0.57 | 0.66 | 0.49 | 0.30 | 0.77 | 0.56 | 0.33 | 0.71 | 0.65 | n/a |
| | 7 (178) | 0.85 | 0.76 | 0.66 | 0.90 | 0.66 | 0.38 | 0.65 | 0.62 | 0.59 | 0.83 | 0.62 | 0.37 | 0.90 | 0.66 | 0.38 | 0.77 | 0.70 | n/a |
| | 8 (203) | 0.90 | 0.80 | 0.68 | 1.00 | 0.75 | 0.43 | 0.67 | 0.64 | 0.60 | 1.00 | 0.76 | 0.46 | 1.00 | 0.75 | 0.43 | 0.82 | 0.75 | n/a |
| | 8-3/4 (222) | 0.93 | 0.82 | 0.69 | | 0.82 | 0.48 | 0.68 | 0.65 | 0.61 | | 0.87 | 0.52 | | 0.82 | 0.48 | 0.86 | 0.78 | 0.66 |
| | 9 (229) | 0.94 | 0.83 | 0.70 | | 0.84 | 0.49 | 0.69 | 0.66 | 0.61 | | 0.91 | 0.55 | | 0.84 | 0.49 | 0.87 | 0.79 | 0.67 |
| | 10 (254) | 0.99 | 0.87 | 0.72 | | 0.94 | 0.54 | 0.71 | 0.67 | 0.62 | | 1.00 | 0.64 | | 0.94 | 0.54 | 0.92 | 0.83 | 0.70 |
| | 11 (279) | 1.00 | 0.91 | 0.74 | | 1.00 | 0.60 | 0.73 | 0.69 | 0.64 | | | 0.74 | | 1.00 | 0.60 | 0.96 | 0.87 | 0.74 |
| | 12 (305) | | 0.94 | 0.77 | | | 0.65 | 0.75 | 0.71 | 0.65 | | | 0.84 | | | 0.65 | 1.00 | 0.91 | 0.77 |
| | 14 (356) | | 1.00 | 0.81 | | | 0.76 | 0.79 | 0.74 | 0.67 | | | 1.00 | | | 0.76 | | 0.99 | 0.83 |
| | 16 (406) | | | 0.86 | | | 0.87 | 0.84 | 0.78 | 0.70 | | | | | | 0.87 | | 1.00 | 0.89 |
| | 18 (457) | | | 0.90 | | | 0.98 | 0.88 | 0.81 | 0.72 | | | | | | 0.98 | | | 0.94 |
| | 24 (610) | | | 1.00 | | | 1.00 | 1.00 | 0.92 | 0.80 | | | | | | 1.00 | | | 1.00 |
| 30 (762) | | | | | | | | 1.00 | 0.87 | | | | | | | | | | |
| 36 (914) | | | | | | | | | 0.94 | | | | | | | | | | |
| > 48 (1219) | | | | | | | | | 1.00 | | | | | | | | | | |

Table 5 – Load adjustment factors for #3 rebar in cracked concrete ^{1,2,3}

| | #3 Cracked concrete | Spacing factor in tension f_{AN} | | | Edge distance factor in tension f_{RN} | | | Spacing factor in shear ⁴ f_{AV} | | | Edge distance in shear | | | | | | Concrete thickness factor in shear ⁵ f_{HV} | | |
|---|------------------------|--|---------------|----------------|--|---------------|----------------|---|---------------|----------------|------------------------------|---------------|----------------|--------------------------|---------------|----------------|--|---------------|----------------|
| | | | | | | | | | | | ⊥ Toward edge f_{RV} | | | ∥ To edge f_{RV} | | | | | |
| | | Embedment h_{ef} in (mm) | 3-3/8 (86) | 4-1/2 (114) | 7-1/2 (191) | 3-3/8 (86) | 4-1/2 (114) | 7-1/2 (191) | 3-3/8 (86) | 4-1/2 (114) | 7-1/2 (191) | 3-3/8 (86) | 4-1/2 (114) | 7-1/2 (191) | 3-3/8 (86) | 4-1/2 (114) | 7-1/2 (191) | 3-3/8 (86) | 4-1/2 (114) |
| Spacing (s) / edge distance (c_a) / concrete thickness (h), - in (mm) | 1-3/4 (44) | n/a | n/a | n/a | 0.54 | 0.49 | 0.43 | n/a | n/a | n/a | 0.10 | 0.07 | 0.04 | 0.20 | 0.15 | 0.09 | n/a | n/a | n/a |
| | 1-7/8 (48) | 0.59 | 0.57 | 0.54 | 0.56 | 0.50 | 0.44 | 0.54 | 0.53 | 0.52 | 0.11 | 0.08 | 0.05 | 0.22 | 0.17 | 0.10 | n/a | n/a | n/a |
| | 2 (51) | 0.60 | 0.57 | 0.54 | 0.57 | 0.51 | 0.44 | 0.54 | 0.53 | 0.52 | 0.12 | 0.09 | 0.05 | 0.24 | 0.18 | 0.11 | n/a | n/a | n/a |
| | 3 (76) | 0.65 | 0.61 | 0.57 | 0.70 | 0.60 | 0.49 | 0.56 | 0.55 | 0.54 | 0.22 | 0.17 | 0.10 | 0.45 | 0.34 | 0.20 | n/a | n/a | n/a |
| | 4 (102) | 0.70 | 0.65 | 0.59 | 0.84 | 0.70 | 0.55 | 0.58 | 0.57 | 0.55 | 0.34 | 0.26 | 0.15 | 0.69 | 0.52 | 0.31 | n/a | n/a | n/a |
| | 4-5/8 (117) | 0.73 | 0.67 | 0.60 | 0.93 | 0.76 | 0.58 | 0.59 | 0.58 | 0.56 | 0.43 | 0.32 | 0.19 | 0.86 | 0.64 | 0.38 | 0.62 | n/a | n/a |
| | 5 (127) | 0.75 | 0.69 | 0.61 | 0.99 | 0.80 | 0.60 | 0.60 | 0.58 | 0.56 | 0.48 | 0.36 | 0.22 | 0.96 | 0.72 | 0.43 | 0.64 | n/a | n/a |
| | 5-3/4 (146) | 0.78 | 0.71 | 0.63 | 1.00 | 0.88 | 0.64 | 0.62 | 0.60 | 0.57 | 0.59 | 0.44 | 0.27 | 1.00 | 0.88 | 0.53 | 0.69 | 0.62 | n/a |
| | 6 (152) | 0.80 | 0.72 | 0.63 | | 0.91 | 0.66 | 0.62 | 0.60 | 0.57 | 0.63 | 0.47 | 0.28 | | 0.91 | 0.57 | 0.70 | 0.64 | n/a |
| | 7 (178) | 0.85 | 0.76 | 0.66 | | 1.00 | 0.72 | 0.64 | 0.62 | 0.58 | 0.80 | 0.60 | 0.36 | | 1.00 | 0.72 | 0.76 | 0.69 | n/a |
| | 8 (203) | 0.90 | 0.80 | 0.68 | | | 0.78 | 0.66 | 0.64 | 0.60 | 0.97 | 0.73 | 0.44 | | | 0.78 | 0.81 | 0.74 | n/a |
| | 8-3/4 (222) | 0.93 | 0.82 | 0.69 | | | 0.83 | 0.68 | 0.65 | 0.61 | 1.00 | 0.83 | 0.50 | | | 0.83 | 0.85 | 0.77 | 0.65 |
| | 9 (229) | 0.94 | 0.83 | 0.70 | | | 0.85 | 0.68 | 0.65 | 0.61 | | 0.87 | 0.52 | | | 0.85 | 0.86 | 0.78 | 0.66 |
| | 10 (254) | 0.99 | 0.87 | 0.72 | | | 0.91 | 0.70 | 0.67 | 0.62 | | 1.00 | 0.61 | | | 0.91 | 0.90 | 0.82 | 0.69 |
| | 11 (279) | 1.00 | 0.91 | 0.74 | | | 0.98 | 0.73 | 0.69 | 0.63 | | | 0.71 | | | 0.98 | 0.95 | 0.86 | 0.73 |
| | 12 (305) | | 0.94 | 0.77 | | | 1.00 | 0.75 | 0.70 | 0.64 | | | 0.80 | | | 1.00 | 0.99 | 0.90 | 0.76 |
| | 14 (356) | | 1.00 | 0.81 | | | 1.00 | 0.79 | 0.74 | 0.67 | | | 1.00 | | | 1.00 | 1.00 | 0.97 | 0.82 |
| | 16 (406) | | | 0.86 | | | | 0.83 | 0.77 | 0.69 | | | | | | | | 1.00 | 0.88 |
| | 18 (457) | | | 0.90 | | | | 0.87 | 0.80 | 0.72 | | | | | | | | | 0.93 |
| | 24 (610) | | | 1.00 | | | | 0.99 | 0.91 | 0.79 | | | | | | | | | 1.00 |
| 30 (762) | | | | | | | 1.00 | 1.00 | 0.86 | | | | | | | | | | |
| 36 (914) | | | | | | | | | 0.93 | | | | | | | | | | |
| > 48 (1219) | | | | | | | | | 1.00 | | | | | | | | | | |

1 Linear interpolation not permitted

2 Shaded area with reduced edge distance is permitted provided the rebar has no installation torque.

3 When combining multiple load adjustment factors (e.g. for a four-anchor pattern in a corner with thin concrete member) the design can become very conservative. To optimize the design, use Hilti PROFIS Anchor Design software or perform anchor calculation using design equations from ACI 318 Chapter 17.

4 Spacing factor reduction in shear applicable when $c_a < 3 \cdot h_{ef}$, f_{AV} is applicable when edge distance, $c_a < 3 \cdot h_{ef}$. If $c_a \geq 3 \cdot h_{ef}$, then $f_{AV} = f_{AN}$.

5 Concrete thickness reduction factor in shear, f_{HV} , is applicable when edge distance, $c_a < 3 \cdot h_{ef}$. If $c_a \geq 3 \cdot h_{ef}$, then $f_{HV} = 1.0$.

Table 6 – Load adjustment factors for #4 rebar in uncracked concrete ^{1,2,3}

| #4 Uncracked concrete | Spacing factor in tension f_{AN} | | | Edge distance factor in tension f_{RN} | | | Spacing factor in shear ⁴ f_{AV} | | | Edge distance in shear | | | | | | Concrete thickness factor in shear ⁵ f_{HV} | | | |
|---|---------------------------------------|----------------|------------|---|----------------|------------|--|----------------|------------|------------------------------|----------------|------------|--------------------------|----------------|------------|---|----------------|------------|-------------|
| | | | | | | | | | | └ Toward edge f_{RV} | | | ┐ To edge f_{RV} | | | | | | |
| | Embedment h_{ef} in (mm) | 4-1/2 (114) | 6 (152) | 10 (254) | 4-1/2 (114) | 6 (152) | 10 (254) | 4-1/2 (114) | 6 (152) | 10 (254) | 4-1/2 (114) | 6 (152) | 10 (254) | 4-1/2 (114) | 6 (152) | 10 (254) | 4-1/2 (114) | 6 (152) | 10 (254) |
| Spacing (s) / edge distance (c_a) / concrete thickness (h), - in (mm) | 1-3/4 (44) | n/a | n/a | n/a | 0.27 | 0.20 | 0.12 | n/a | n/a | n/a | 0.07 | 0.05 | 0.03 | 0.14 | 0.10 | 0.06 | n/a | n/a | n/a |
| | 2-1/2 (64) | 0.59 | 0.57 | 0.54 | 0.32 | 0.23 | 0.14 | 0.54 | 0.53 | 0.52 | 0.12 | 0.09 | 0.05 | 0.23 | 0.17 | 0.10 | n/a | n/a | n/a |
| | 3 (76) | 0.61 | 0.58 | 0.55 | 0.35 | 0.26 | 0.15 | 0.55 | 0.54 | 0.53 | 0.15 | 0.11 | 0.07 | 0.31 | 0.23 | 0.14 | n/a | n/a | n/a |
| | 4 (102) | 0.65 | 0.61 | 0.57 | 0.41 | 0.30 | 0.18 | 0.56 | 0.55 | 0.54 | 0.23 | 0.18 | 0.11 | 0.41 | 0.30 | 0.18 | n/a | n/a | n/a |
| | 5 (127) | 0.69 | 0.64 | 0.58 | 0.48 | 0.35 | 0.21 | 0.58 | 0.57 | 0.55 | 0.33 | 0.25 | 0.15 | 0.48 | 0.35 | 0.21 | n/a | n/a | n/a |
| | 5-3/4 (146) | 0.71 | 0.66 | 0.60 | 0.54 | 0.40 | 0.23 | 0.59 | 0.58 | 0.55 | 0.40 | 0.30 | 0.18 | 0.54 | 0.40 | 0.23 | 0.60 | n/a | n/a |
| | 6 (152) | 0.72 | 0.67 | 0.60 | 0.56 | 0.41 | 0.24 | 0.60 | 0.58 | 0.56 | 0.43 | 0.32 | 0.19 | 0.56 | 0.41 | 0.24 | 0.62 | n/a | n/a |
| | 7 (178) | 0.76 | 0.69 | 0.62 | 0.66 | 0.48 | 0.28 | 0.61 | 0.59 | 0.57 | 0.54 | 0.41 | 0.24 | 0.66 | 0.48 | 0.28 | 0.67 | n/a | n/a |
| | 7-1/4 (184) | 0.77 | 0.70 | 0.62 | 0.68 | 0.50 | 0.29 | 0.62 | 0.59 | 0.57 | 0.57 | 0.43 | 0.26 | 0.68 | 0.50 | 0.29 | 0.68 | 0.62 | n/a |
| | 8 (203) | 0.80 | 0.72 | 0.63 | 0.75 | 0.55 | 0.32 | 0.63 | 0.60 | 0.57 | 0.66 | 0.50 | 0.30 | 0.75 | 0.55 | 0.32 | 0.71 | 0.65 | n/a |
| | 9 (229) | 0.83 | 0.75 | 0.65 | 0.85 | 0.62 | 0.36 | 0.64 | 0.62 | 0.58 | 0.79 | 0.59 | 0.36 | 0.85 | 0.62 | 0.36 | 0.76 | 0.69 | n/a |
| | 10 (254) | 0.87 | 0.78 | 0.67 | 0.94 | 0.69 | 0.40 | 0.66 | 0.63 | 0.59 | 0.93 | 0.70 | 0.42 | 0.94 | 0.69 | 0.40 | 0.80 | 0.72 | n/a |
| | 11-1/4 (286) | 0.92 | 0.81 | 0.69 | 1.00 | 0.78 | 0.45 | 0.68 | 0.65 | 0.60 | 1.00 | 0.83 | 0.50 | 1.00 | 0.78 | 0.45 | 0.84 | 0.77 | 0.65 |
| | 12 (305) | 0.94 | 0.83 | 0.70 | | 0.83 | 0.48 | 0.69 | 0.66 | 0.61 | | 0.92 | 0.55 | | 0.83 | 0.48 | 0.87 | 0.79 | 0.67 |
| | 14 (356) | 1.00 | 0.89 | 0.73 | | 0.97 | 0.56 | 0.72 | 0.68 | 0.63 | | 1.00 | 0.69 | | 0.97 | 0.56 | 0.94 | 0.86 | 0.72 |
| | 16 (406) | | 0.94 | 0.77 | | 1.00 | 0.65 | 0.75 | 0.71 | 0.65 | | | 0.85 | | 1.00 | 0.65 | 1.00 | 0.92 | 0.77 |
| | 18 (457) | | 1.00 | 0.80 | | | 0.73 | 0.79 | 0.74 | 0.67 | | | 1.00 | | | 0.73 | | 0.97 | 0.82 |
| | 20 (508) | | | 0.83 | | | 0.81 | 0.82 | 0.76 | 0.69 | | | | | | 0.81 | | 1.00 | 0.86 |
| | 22 (559) | | | 0.87 | | | 0.89 | 0.85 | 0.79 | 0.70 | | | | | | 0.89 | | | 0.91 |
| 24 (610) | | | 0.90 | | | 0.97 | 0.88 | 0.81 | 0.72 | | | | | | 0.97 | | | 0.95 | |
| 30 (762) | | | 1.00 | | | 1.00 | 0.98 | 0.89 | 0.78 | | | | | | 1.00 | | | 1.00 | |
| 36 (914) | | | | | | | 1.00 | 0.97 | 0.84 | | | | | | | | | | |
| > 48 (1219) | | | | | | | | 1.00 | 0.95 | | | | | | | | | | |

Table 7 – Load adjustment factors for #4 rebar in cracked concrete ^{1,2,3}

| #4 Cracked concrete | Spacing factor in tension f_{AN} | | | Edge distance factor in tension f_{RN} | | | Spacing factor in shear ⁴ f_{AV} | | | Edge distance in shear | | | | | | Concrete thickness factor in shear ⁵ f_{HV} | | | |
|---|---------------------------------------|----------------|------------|---|----------------|------------|--|----------------|------------|------------------------------|----------------|------------|--------------------------|----------------|------------|---|----------------|------------|-------------|
| | | | | | | | | | | └ Toward edge f_{RV} | | | ┐ To edge f_{RV} | | | | | | |
| | Embedment h_{ef} in (mm) | 4-1/2 (114) | 6 (152) | 10 (254) | 4-1/2 (114) | 6 (152) | 10 (254) | 4-1/2 (114) | 6 (152) | 10 (254) | 4-1/2 (114) | 6 (152) | 10 (254) | 4-1/2 (114) | 6 (152) | 10 (254) | 4-1/2 (114) | 6 (152) | 10 (254) |
| Spacing (s) / edge distance (c_a) / concrete thickness (h), - in (mm) | 1-3/4 (44) | n/a | n/a | n/a | 0.49 | 0.45 | 0.41 | n/a | n/a | n/a | 0.06 | 0.05 | 0.03 | 0.13 | 0.10 | 0.06 | n/a | n/a | n/a |
| | 2-1/2 (64) | 0.59 | 0.57 | 0.54 | 0.56 | 0.50 | 0.44 | 0.54 | 0.53 | 0.52 | 0.11 | 0.08 | 0.05 | 0.22 | 0.17 | 0.10 | n/a | n/a | n/a |
| | 3 (76) | 0.61 | 0.58 | 0.55 | 0.60 | 0.53 | 0.46 | 0.55 | 0.54 | 0.53 | 0.15 | 0.11 | 0.07 | 0.29 | 0.22 | 0.13 | n/a | n/a | n/a |
| | 4 (102) | 0.65 | 0.61 | 0.57 | 0.70 | 0.60 | 0.49 | 0.56 | 0.55 | 0.54 | 0.22 | 0.17 | 0.10 | 0.45 | 0.34 | 0.20 | n/a | n/a | n/a |
| | 5 (127) | 0.69 | 0.64 | 0.58 | 0.80 | 0.67 | 0.53 | 0.58 | 0.56 | 0.55 | 0.31 | 0.23 | 0.14 | 0.62 | 0.47 | 0.28 | n/a | n/a | n/a |
| | 5-3/4 (146) | 0.71 | 0.66 | 0.60 | 0.88 | 0.73 | 0.56 | 0.59 | 0.57 | 0.55 | 0.39 | 0.29 | 0.17 | 0.77 | 0.58 | 0.35 | 0.59 | n/a | n/a |
| | 6 (152) | 0.72 | 0.67 | 0.60 | 0.91 | 0.75 | 0.57 | 0.59 | 0.58 | 0.55 | 0.41 | 0.31 | 0.18 | 0.82 | 0.62 | 0.37 | 0.61 | n/a | n/a |
| | 7 (178) | 0.76 | 0.69 | 0.62 | 1.00 | 0.83 | 0.62 | 0.61 | 0.59 | 0.56 | 0.52 | 0.39 | 0.23 | 1.00 | 0.78 | 0.47 | 0.66 | n/a | n/a |
| | 7-1/4 (184) | 0.77 | 0.70 | 0.62 | | 0.85 | 0.63 | 0.61 | 0.59 | 0.57 | 0.55 | 0.41 | 0.25 | | 0.82 | 0.49 | 0.67 | 0.61 | n/a |
| | 8 (203) | 0.80 | 0.72 | 0.63 | | 0.91 | 0.66 | 0.62 | 0.60 | 0.57 | 0.63 | 0.47 | 0.28 | | 0.91 | 0.57 | 0.70 | 0.64 | n/a |
| | 9 (229) | 0.83 | 0.75 | 0.65 | | 1.00 | 0.70 | 0.64 | 0.61 | 0.58 | 0.75 | 0.57 | 0.34 | | 1.00 | 0.68 | 0.74 | 0.68 | n/a |
| | 10 (254) | 0.87 | 0.78 | 0.67 | | | 0.75 | 0.65 | 0.63 | 0.59 | 0.88 | 0.66 | 0.40 | | | 0.75 | 0.78 | 0.71 | n/a |
| | 11-1/4 (286) | 0.92 | 0.81 | 0.69 | | | 0.81 | 0.67 | 0.64 | 0.60 | 1.00 | 0.79 | 0.47 | | | 0.81 | 0.83 | 0.75 | 0.64 |
| | 12 (305) | 0.94 | 0.83 | 0.70 | | | 0.85 | 0.68 | 0.65 | 0.61 | | 0.87 | 0.52 | | | 0.85 | 0.86 | 0.78 | 0.66 |
| | 14 (356) | 1.00 | 0.89 | 0.73 | | | 0.95 | 0.71 | 0.68 | 0.63 | | 1.00 | 0.66 | | | 0.95 | 0.93 | 0.84 | 0.71 |
| | 16 (406) | | 0.94 | 0.77 | | | 1.00 | 0.75 | 0.70 | 0.64 | | | 0.80 | | | 1.00 | 0.99 | 0.90 | 0.76 |
| | 18 (457) | | 1.00 | 0.80 | | | | 0.78 | 0.73 | 0.66 | | | 0.96 | | | | 1.00 | 0.95 | 0.81 |
| | 20 (508) | | | 0.83 | | | | 0.81 | 0.75 | 0.68 | | | 1.00 | | | | | 1.00 | 0.85 |
| | 22 (559) | | | 0.87 | | | | 0.84 | 0.78 | 0.70 | | | | | | | | | 0.89 |
| 24 (610) | | | 0.90 | | | | 0.87 | 0.80 | 0.72 | | | | | | | | | 0.93 | |
| 30 (762) | | | 1.00 | | | | 0.96 | 0.88 | 0.77 | | | | | | | | | 1.00 | |
| 36 (914) | | | | | | | 1.00 | 0.96 | 0.82 | | | | | | | | | | |
| > 48 (1219) | | | | | | | | 1.00 | 0.93 | | | | | | | | | | |

1 Linear interpolation not permitted

2 Shaded area with reduced edge distance is permitted provided the rebar has no installation torque.

3 When combining multiple load adjustment factors (e.g. for a four-anchor pattern in a corner with thin concrete member) the design can become very conservative. To optimize the design, use Hilti PROFIS Anchor Design software or perform anchor calculation using design equations from ACI 318 Chapter 17.

4 Spacing factor reduction in shear applicable when $c_a < 3 \cdot h_{ef}$, f_{AV} is applicable when edge distance, $c_a < 3 \cdot h_{ef}$. If $c_a \geq 3 \cdot h_{ef}$, then $f_{AV} = f_{AN}$.

5 Concrete thickness reduction factor in shear, f_{HV} , is applicable when edge distance, $c_a < 3 \cdot h_{ef}$. If $c_a \geq 3 \cdot h_{ef}$, then $f_{HV} = 1.0$.

Table 8 – Load adjustment factors for #5 rebar in uncracked concrete^{1,2,3}

| | #5 Uncracked concrete | Spacing factor in tension f_{AN} | | | Edge distance factor in tension f_{RN} | | | Spacing factor in shear ⁴ f_{AV} | | | Edge distance in shear | | | | | | Concrete thickness factor in shear ⁵ f_{HV} | | |
|-------------------------------|--------------------------|--|-----------------|----------------|--|-----------------|----------------|---|-----------------|----------------|------------------------------|-----------------|----------------|--------------------------|-----------------|----------------|--|-----------------|--|
| | | Toward edge f_{RV} | | | To edge f_{RV} | | | | | | ⊥ Toward edge f_{RV} | | | ∥ To edge f_{RV} | | | | | |
| Embedment h_{ef} in (mm) | 5-5/8 (143) | 7-1/2 (191) | 12-1/2 (318) | 5-5/8 (143) | 7-1/2 (191) | 12-1/2 (318) | 5-5/8 (143) | 7-1/2 (191) | 12-1/2 (318) | 5-5/8 (143) | 7-1/2 (191) | 12-1/2 (318) | 5-5/8 (143) | 7-1/2 (191) | 12-1/2 (318) | 5-5/8 (143) | 7-1/2 (191) | 12-1/2 (318) | |
| 1-3/4 (44) | n/a | n/a | n/a | 0.25 | 0.19 | 0.11 | n/a | n/a | n/a | 0.05 | 0.04 | 0.02 | 0.10 | 0.07 | 0.04 | n/a | n/a | n/a | |
| 2-1/2 (64) | 0.59 | 0.57 | 0.54 | 0.32 | 0.23 | 0.14 | 0.54 | 0.53 | 0.52 | 0.12 | 0.09 | 0.05 | 0.23 | 0.18 | 0.11 | n/a | n/a | n/a | |
| 3 (76) | 0.62 | 0.59 | 0.55 | 0.36 | 0.26 | 0.15 | 0.55 | 0.54 | 0.53 | 0.17 | 0.13 | 0.08 | 0.34 | 0.25 | 0.15 | n/a | n/a | n/a | |
| 4 (102) | 0.65 | 0.61 | 0.57 | 0.41 | 0.30 | 0.18 | 0.56 | 0.55 | 0.54 | 0.24 | 0.18 | 0.11 | 0.41 | 0.30 | 0.18 | n/a | n/a | n/a | |
| 5 (127) | 0.68 | 0.63 | 0.58 | 0.47 | 0.34 | 0.20 | 0.58 | 0.56 | 0.55 | 0.31 | 0.23 | 0.14 | 0.47 | 0.34 | 0.20 | n/a | n/a | n/a | |
| 5-3/4 (146) | 0.71 | 0.66 | 0.59 | 0.53 | 0.39 | 0.23 | 0.59 | 0.57 | 0.55 | 0.39 | 0.29 | 0.18 | 0.53 | 0.39 | 0.23 | n/a | n/a | n/a | |
| 6 (152) | 0.71 | 0.66 | 0.60 | 0.54 | 0.39 | 0.23 | 0.59 | 0.58 | 0.55 | 0.40 | 0.30 | 0.18 | 0.54 | 0.39 | 0.23 | 0.60 | n/a | n/a | |
| 7 (178) | 0.74 | 0.68 | 0.61 | 0.60 | 0.44 | 0.26 | 0.60 | 0.58 | 0.56 | 0.48 | 0.36 | 0.22 | 0.60 | 0.44 | 0.26 | 0.64 | n/a | n/a | |
| 7-1/4 (184) | 0.77 | 0.70 | 0.62 | 0.68 | 0.50 | 0.29 | 0.61 | 0.59 | 0.57 | 0.57 | 0.43 | 0.26 | 0.68 | 0.50 | 0.29 | 0.68 | 0.62 | n/a | |
| 8 (203) | 0.80 | 0.72 | 0.63 | 0.75 | 0.55 | 0.32 | 0.63 | 0.61 | 0.58 | 0.67 | 0.50 | 0.30 | 0.75 | 0.55 | 0.32 | 0.71 | 0.65 | n/a | |
| 9 (229) | 0.83 | 0.74 | 0.65 | 0.83 | 0.61 | 0.36 | 0.64 | 0.62 | 0.58 | 0.77 | 0.58 | 0.35 | 0.83 | 0.61 | 0.36 | 0.75 | 0.68 | n/a | |
| 10 (254) | 0.86 | 0.77 | 0.66 | 0.90 | 0.66 | 0.39 | 0.65 | 0.63 | 0.59 | 0.88 | 0.66 | 0.40 | 0.90 | 0.66 | 0.39 | 0.78 | 0.71 | n/a | |
| 11-1/4 (286) | 0.91 | 0.81 | 0.69 | 1.00 | 0.77 | 0.45 | 0.68 | 0.65 | 0.61 | 1.00 | 0.83 | 0.50 | 1.00 | 0.77 | 0.45 | 0.85 | 0.77 | 0.65 | |
| 12 (305) | 0.97 | 0.86 | 0.71 | | 0.88 | 0.52 | 0.70 | 0.67 | 0.62 | | 1.00 | 0.61 | | 0.88 | 0.52 | 0.90 | 0.82 | 0.69 | |
| 14 (356) | 1.00 | 0.90 | 0.74 | | 0.99 | 0.58 | 0.73 | 0.69 | 0.64 | | | 0.73 | | 0.99 | 0.58 | 0.96 | 0.87 | 0.73 | |
| 16 (406) | | 0.94 | 0.77 | | 1.00 | 0.65 | 0.76 | 0.71 | 0.65 | | | 0.85 | | 1.00 | 0.65 | 1.00 | 0.92 | 0.77 | |
| 18 (457) | | 0.99 | 0.79 | | | 0.71 | 0.78 | 0.73 | 0.67 | | | 0.99 | | | 0.71 | | 0.96 | 0.81 | |
| 20 (508) | | 1.00 | 0.82 | | | 0.78 | 0.81 | 0.75 | 0.68 | | | 1.00 | | | 0.78 | | 1.00 | 0.85 | |
| 22 (559) | | | 0.85 | | | 0.84 | 0.83 | 0.77 | 0.70 | | | | | | 0.84 | | | 0.88 | |
| 24 (610) | | | 0.87 | | | 0.91 | 0.86 | 0.80 | 0.71 | | | | | | 0.91 | | | 0.92 | |
| 30 (762) | | | 0.90 | | | 0.97 | 0.88 | 0.82 | 0.73 | | | | | | 0.97 | | | 0.95 | |
| 36 (914) | | | 0.98 | | | 1.00 | 0.96 | 0.88 | 0.77 | | | | | | 1.00 | | | 1.00 | |
| > 48 (1219) | | | 1.00 | | | | 1.00 | 1.00 | 0.86 | | | | | | | | | | |

Table 9 – Load adjustment factors for #5 rebar in cracked concrete^{1,2,3}

| | #5 Cracked concrete | Spacing factor in tension f_{AN} | | | Edge distance factor in tension f_{RN} | | | Spacing factor in shear ⁴ f_{AV} | | | Edge distance in shear | | | | | | Concrete thickness factor in shear ⁵ f_{HV} | | |
|-------------------------------|------------------------|--|-----------------|----------------|--|-----------------|----------------|---|-----------------|----------------|------------------------------|-----------------|----------------|--------------------------|-----------------|----------------|--|-----------------|--|
| | | Toward edge f_{RV} | | | To edge f_{RV} | | | | | | ⊥ Toward edge f_{RV} | | | ∥ To edge f_{RV} | | | | | |
| Embedment h_{ef} in (mm) | 5-5/8 (143) | 7-1/2 (191) | 12-1/2 (318) | 5-5/8 (143) | 7-1/2 (191) | 12-1/2 (318) | 5-5/8 (143) | 7-1/2 (191) | 12-1/2 (318) | 5-5/8 (143) | 7-1/2 (191) | 12-1/2 (318) | 5-5/8 (143) | 7-1/2 (191) | 12-1/2 (318) | 5-5/8 (143) | 7-1/2 (191) | 12-1/2 (318) | |
| 1-3/4 (44) | n/a | n/a | n/a | 0.46 | 0.43 | 0.40 | n/a | n/a | n/a | 0.05 | 0.03 | 0.02 | 0.09 | 0.07 | 0.04 | n/a | n/a | n/a | |
| 2-1/2 (64) | 0.59 | 0.57 | 0.54 | 0.56 | 0.50 | 0.44 | 0.54 | 0.53 | 0.52 | 0.11 | 0.08 | 0.05 | 0.22 | 0.17 | 0.10 | n/a | n/a | n/a | |
| 3 (76) | 0.62 | 0.59 | 0.55 | 0.62 | 0.55 | 0.46 | 0.55 | 0.54 | 0.53 | 0.16 | 0.12 | 0.07 | 0.32 | 0.24 | 0.14 | n/a | n/a | n/a | |
| 4 (102) | 0.65 | 0.61 | 0.57 | 0.70 | 0.60 | 0.49 | 0.56 | 0.55 | 0.54 | 0.22 | 0.17 | 0.10 | 0.45 | 0.34 | 0.20 | n/a | n/a | n/a | |
| 5 (127) | 0.68 | 0.63 | 0.58 | 0.78 | 0.66 | 0.53 | 0.57 | 0.56 | 0.54 | 0.29 | 0.22 | 0.13 | 0.59 | 0.44 | 0.26 | n/a | n/a | n/a | |
| 5-3/4 (146) | 0.71 | 0.66 | 0.59 | 0.87 | 0.72 | 0.56 | 0.59 | 0.57 | 0.55 | 0.37 | 0.28 | 0.17 | 0.74 | 0.56 | 0.33 | n/a | n/a | n/a | |
| 6 (152) | 0.71 | 0.66 | 0.60 | 0.88 | 0.73 | 0.56 | 0.59 | 0.57 | 0.55 | 0.38 | 0.29 | 0.17 | 0.76 | 0.57 | 0.34 | 0.59 | n/a | n/a | |
| 7 (178) | 0.74 | 0.68 | 0.61 | 0.96 | 0.78 | 0.59 | 0.60 | 0.58 | 0.56 | 0.45 | 0.34 | 0.20 | 0.90 | 0.68 | 0.41 | 0.63 | n/a | n/a | |
| 7-1/4 (184) | 0.77 | 0.70 | 0.62 | 1.00 | 0.85 | 0.62 | 0.61 | 0.59 | 0.56 | 0.54 | 0.40 | 0.24 | 1.00 | 0.81 | 0.49 | 0.66 | 0.60 | n/a | |
| 8 (203) | 0.80 | 0.72 | 0.63 | | 0.91 | 0.66 | 0.62 | 0.60 | 0.57 | 0.63 | 0.47 | 0.28 | | 0.91 | 0.57 | 0.70 | 0.64 | n/a | |
| 9 (229) | 0.83 | 0.74 | 0.65 | | 0.98 | 0.69 | 0.64 | 0.61 | 0.58 | 0.73 | 0.55 | 0.33 | | 0.98 | 0.66 | 0.73 | 0.67 | n/a | |
| 10 (254) | 0.86 | 0.77 | 0.66 | | 1.00 | 0.73 | 0.65 | 0.62 | 0.59 | 0.83 | 0.62 | 0.37 | | 1.00 | 0.73 | 0.77 | 0.70 | n/a | |
| 11-1/4 (286) | 0.91 | 0.81 | 0.69 | | | 0.81 | 0.67 | 0.64 | 0.60 | 1.00 | 0.79 | 0.47 | | | 0.81 | 0.83 | 0.75 | 0.64 | |
| 12 (305) | 0.97 | 0.86 | 0.71 | | | 0.89 | 0.70 | 0.66 | 0.62 | | 0.96 | 0.58 | | | 0.89 | 0.89 | 0.81 | 0.68 | |
| 14 (356) | 1.00 | 0.90 | 0.74 | | | 0.97 | 0.72 | 0.68 | 0.63 | | 1.00 | 0.69 | | | 0.97 | 0.94 | 0.85 | 0.72 | |
| 16 (406) | | 0.94 | 0.77 | | | 1.00 | 0.75 | 0.70 | 0.64 | | | 0.80 | | | 1.00 | 0.99 | 0.90 | 0.76 | |
| 18 (457) | | 0.99 | 0.79 | | | | 0.77 | 0.72 | 0.66 | | | 0.93 | | | 1.00 | 0.94 | 0.80 | | |
| 20 (508) | | 1.00 | 0.82 | | | | 0.79 | 0.74 | 0.67 | | | 1.00 | | | | 0.99 | 0.83 | | |
| 22 (559) | | | 0.85 | | | | 0.82 | 0.76 | 0.69 | | | | | | | 1.00 | 0.87 | | |
| 24 (610) | | | 0.87 | | | | 0.84 | 0.78 | 0.70 | | | | | | | | | 0.90 | |
| 30 (762) | | | 0.90 | | | | 0.87 | 0.80 | 0.72 | | | | | | | | | 0.93 | |
| 36 (914) | | | 0.98 | | | | 0.94 | 0.86 | 0.76 | | | | | | | | | 1.00 | |
| > 48 (1219) | | | 1.00 | | | | 1.00 | 0.99 | 0.85 | | | | | | | | | | |

1 Linear interpolation not permitted
 2 Shaded area with reduced edge distance is permitted provided the rebar has no installation torque.
 3 When combining multiple load adjustment factors (e.g. for a four-anchor pattern in a corner with thin concrete member) the design can become very conservative. To optimize the design, use Hilti PROFIS Anchor Design software or perform anchor calculation using design equations from ACI 318 Chapter 17.
 4 Spacing factor reduction in shear applicable when $c_a < 3 \cdot h_{ef}$, f_{AV} is applicable when edge distance, $c_a < 3 \cdot h_{ef}$. If $c_a \geq 3 \cdot h_{ef}$, then $f_{AV} = f_{AN}$.
 5 Concrete thickness reduction factor in shear, f_{HV} is applicable when edge distance, $c_a < 3 \cdot h_{ef}$. If $c_a \geq 3 \cdot h_{ef}$, then $f_{HV} = 1.0$.

Table 10 – Load adjustment factors for #6 rebar in uncracked concrete ^{1,2,3}

| #6 Uncracked concrete | Spacing factor in tension | | | Edge distance factor in tension | | | Spacing factor in shear ⁴ | | | Edge distance in shear | | | | | | Concrete thickness factor in shear ⁵ | | | |
|---|-------------------------------|----------------|------------|---------------------------------|----------------|------------|--------------------------------------|----------------|------------|------------------------------|----------------|------------|--------------------------|----------------|------------|---|----------------|------------|-------------|
| | f_{AN} | | | f_{RN} | | | f_{AV} | | | ⊥ Toward edge f_{RV} | | | ∥ To edge f_{RV} | | | f_{HV} | | | |
| | Embedment h_{ef} in (mm) | 6-3/4 (171) | 9 (229) | 15 (381) | 6-3/4 (171) | 9 (229) | 15 (381) | 6-3/4 (171) | 9 (229) | 15 (381) | 6-3/4 (171) | 9 (229) | 15 (381) | 6-3/4 (171) | 9 (229) | 15 (381) | 6-3/4 (171) | 9 (229) | 15 (381) |
| Spacing (s) / edge distance (c_a) / concrete thickness (h), - in (mm) | 1-3/4 (44) | n/a | n/a | n/a | 0.24 | 0.18 | 0.10 | n/a | n/a | n/a | 0.04 | 0.03 | 0.02 | 0.07 | 0.06 | 0.03 | n/a | n/a | n/a |
| | 3-3/4 (95) | 0.59 | 0.57 | 0.54 | 0.32 | 0.23 | 0.14 | 0.54 | 0.53 | 0.52 | 0.12 | 0.09 | 0.05 | 0.23 | 0.17 | 0.10 | n/a | n/a | n/a |
| | 4 (102) | 0.60 | 0.57 | 0.54 | 0.33 | 0.24 | 0.14 | 0.54 | 0.53 | 0.52 | 0.13 | 0.10 | 0.06 | 0.26 | 0.19 | 0.12 | n/a | n/a | n/a |
| | 5 (127) | 0.62 | 0.59 | 0.56 | 0.37 | 0.27 | 0.16 | 0.55 | 0.54 | 0.53 | 0.18 | 0.13 | 0.08 | 0.36 | 0.27 | 0.16 | n/a | n/a | n/a |
| | 6 (152) | 0.65 | 0.61 | 0.57 | 0.41 | 0.30 | 0.18 | 0.56 | 0.55 | 0.54 | 0.23 | 0.18 | 0.11 | 0.41 | 0.30 | 0.18 | n/a | n/a | n/a |
| | 8 (203) | 0.70 | 0.65 | 0.59 | 0.51 | 0.37 | 0.22 | 0.58 | 0.57 | 0.55 | 0.36 | 0.27 | 0.16 | 0.51 | 0.37 | 0.22 | n/a | n/a | n/a |
| | 8-1/2 (216) | 0.71 | 0.66 | 0.59 | 0.53 | 0.39 | 0.23 | 0.59 | 0.57 | 0.55 | 0.40 | 0.30 | 0.18 | 0.53 | 0.39 | 0.23 | 0.60 | n/a | n/a |
| | 10 (254) | 0.75 | 0.69 | 0.61 | 0.63 | 0.46 | 0.27 | 0.61 | 0.59 | 0.56 | 0.51 | 0.38 | 0.23 | 0.63 | 0.46 | 0.27 | 0.65 | n/a | n/a |
| | 10-3/4 (273) | 0.77 | 0.70 | 0.62 | 0.68 | 0.50 | 0.29 | 0.61 | 0.59 | 0.57 | 0.56 | 0.42 | 0.25 | 0.68 | 0.50 | 0.29 | 0.67 | 0.61 | n/a |
| | 12 (305) | 0.80 | 0.72 | 0.63 | 0.75 | 0.55 | 0.32 | 0.63 | 0.60 | 0.57 | 0.66 | 0.50 | 0.30 | 0.75 | 0.55 | 0.32 | 0.71 | 0.65 | n/a |
| | 14 (356) | 0.85 | 0.76 | 0.66 | 0.88 | 0.65 | 0.38 | 0.65 | 0.62 | 0.59 | 0.84 | 0.63 | 0.38 | 0.88 | 0.65 | 0.38 | 0.77 | 0.70 | n/a |
| | 16 (406) | 0.90 | 0.80 | 0.68 | 1.00 | 0.74 | 0.43 | 0.67 | 0.64 | 0.60 | 1.00 | 0.77 | 0.46 | 1.00 | 0.74 | 0.43 | 0.82 | 0.75 | n/a |
| | 16-3/4 (425) | 0.91 | 0.81 | 0.69 | | 0.77 | 0.45 | 0.68 | 0.65 | 0.60 | | 0.82 | 0.49 | | 0.77 | 0.45 | 0.84 | 0.76 | 0.64 |
| | 18 (457) | 0.94 | 0.83 | 0.70 | | 0.83 | 0.49 | 0.69 | 0.66 | 0.61 | | 0.91 | 0.55 | | 0.83 | 0.49 | 0.87 | 0.79 | 0.67 |
| | 20 (508) | 0.99 | 0.87 | 0.72 | | 0.92 | 0.54 | 0.71 | 0.67 | 0.62 | | 1.00 | 0.64 | | 0.92 | 0.54 | 0.92 | 0.84 | 0.70 |
| | 22 (559) | 1.00 | 0.91 | 0.74 | | 1.00 | 0.59 | 0.73 | 0.69 | 0.64 | | | 0.74 | | 1.00 | 0.59 | 0.96 | 0.88 | 0.74 |
| | 24 (610) | | 0.94 | 0.77 | | | 0.65 | 0.75 | 0.71 | 0.65 | | | 0.85 | | | 0.65 | 1.00 | 0.92 | 0.77 |
| | 26 (660) | | 0.98 | 0.79 | | | 0.70 | 0.77 | 0.73 | 0.66 | | | 0.95 | | | 0.70 | | 0.95 | 0.80 |
| | 28 (711) | | 1.00 | 0.81 | | | 0.76 | 0.80 | 0.74 | 0.67 | | | 1.00 | | | 0.76 | | 0.99 | 0.83 |
| 30 (762) | | | 0.83 | | | 0.81 | 0.82 | 0.76 | 0.69 | | | | | | 0.81 | | 1.00 | 0.86 | |
| 36 (914) | | | 0.90 | | | 0.97 | 0.88 | 0.81 | 0.72 | | | | | | 0.97 | | | 0.95 | |
| > 48 (1219) | | | 1.00 | | | 1.00 | 1.00 | 0.92 | 0.80 | | | | | | 1.00 | | | 1.00 | |

Table 11 – Load adjustment factors for #6 rebar in cracked concrete ^{1,2,3}

| #6 Cracked concrete | Spacing factor in tension | | | Edge distance factor in tension | | | Spacing factor in shear ⁴ | | | Edge distance in shear | | | | | | Concrete thickness factor in shear ⁵ | | | |
|---|-------------------------------|----------------|------------|---------------------------------|----------------|------------|--------------------------------------|----------------|------------|------------------------------|----------------|------------|--------------------------|----------------|------------|---|----------------|------------|-------------|
| | f_{AN} | | | f_{RN} | | | f_{AV} | | | ⊥ Toward edge f_{RV} | | | ∥ To edge f_{RV} | | | f_{HV} | | | |
| | Embedment h_{ef} in (mm) | 6-3/4 (171) | 9 (229) | 15 (381) | 6-3/4 (171) | 9 (229) | 15 (381) | 6-3/4 (171) | 9 (229) | 15 (381) | 6-3/4 (171) | 9 (229) | 15 (381) | 6-3/4 (171) | 9 (229) | 15 (381) | 6-3/4 (171) | 9 (229) | 15 (381) |
| Spacing (s) / edge distance (c_a) / concrete thickness (h), - in (mm) | 1-3/4 (44) | n/a | n/a | n/a | 0.44 | 0.42 | 0.39 | n/a | n/a | n/a | 0.03 | 0.03 | 0.02 | 0.07 | 0.05 | 0.03 | n/a | n/a | n/a |
| | 3-3/4 (95) | 0.59 | 0.57 | 0.54 | 0.56 | 0.50 | 0.44 | 0.54 | 0.53 | 0.52 | 0.11 | 0.08 | 0.05 | 0.22 | 0.16 | 0.10 | n/a | n/a | n/a |
| | 4 (102) | 0.60 | 0.57 | 0.54 | 0.57 | 0.51 | 0.44 | 0.54 | 0.53 | 0.52 | 0.12 | 0.09 | 0.05 | 0.24 | 0.18 | 0.11 | n/a | n/a | n/a |
| | 5 (127) | 0.62 | 0.59 | 0.56 | 0.63 | 0.56 | 0.47 | 0.55 | 0.54 | 0.53 | 0.17 | 0.12 | 0.07 | 0.34 | 0.25 | 0.15 | n/a | n/a | n/a |
| | 6 (152) | 0.65 | 0.61 | 0.57 | 0.70 | 0.60 | 0.49 | 0.56 | 0.55 | 0.54 | 0.22 | 0.16 | 0.10 | 0.44 | 0.33 | 0.20 | n/a | n/a | n/a |
| | 8 (203) | 0.70 | 0.65 | 0.59 | 0.84 | 0.70 | 0.55 | 0.58 | 0.57 | 0.55 | 0.34 | 0.25 | 0.15 | 0.68 | 0.51 | 0.30 | n/a | n/a | n/a |
| | 8-1/2 (216) | 0.71 | 0.66 | 0.59 | 0.88 | 0.72 | 0.56 | 0.59 | 0.57 | 0.55 | 0.37 | 0.28 | 0.17 | 0.75 | 0.55 | 0.33 | 0.59 | n/a | n/a |
| | 10 (254) | 0.75 | 0.69 | 0.61 | 0.99 | 0.80 | 0.60 | 0.60 | 0.58 | 0.56 | 0.48 | 0.35 | 0.21 | 0.95 | 0.71 | 0.42 | 0.64 | n/a | n/a |
| | 10-3/4 (273) | 0.77 | 0.70 | 0.62 | 1.00 | 0.84 | 0.62 | 0.61 | 0.59 | 0.56 | 0.53 | 0.39 | 0.24 | 1.00 | 0.79 | 0.47 | 0.66 | 0.60 | n/a |
| | 12 (305) | 0.80 | 0.72 | 0.63 | | 0.91 | 0.66 | 0.62 | 0.60 | 0.57 | 0.63 | 0.46 | 0.28 | | 0.91 | 0.56 | 0.70 | 0.63 | n/a |
| | 14 (356) | 0.85 | 0.76 | 0.66 | | 1.00 | 0.72 | 0.64 | 0.62 | 0.58 | 0.79 | 0.59 | 0.35 | | 1.00 | 0.70 | 0.76 | 0.68 | n/a |
| | 16 (406) | 0.90 | 0.80 | 0.68 | | | 0.78 | 0.66 | 0.63 | 0.59 | 0.97 | 0.71 | 0.43 | | | 0.78 | 0.81 | 0.73 | n/a |
| | 16-3/4 (425) | 0.91 | 0.81 | 0.69 | | | 0.81 | 0.67 | 0.64 | 0.60 | 1.00 | 0.77 | 0.46 | | | 0.81 | 0.83 | 0.75 | 0.63 |
| | 18 (457) | 0.94 | 0.83 | 0.70 | | | 0.85 | 0.68 | 0.65 | 0.61 | | 0.85 | 0.51 | | | 0.85 | 0.86 | 0.77 | 0.65 |
| | 20 (508) | 0.99 | 0.87 | 0.72 | | | 0.91 | 0.70 | 0.67 | 0.62 | | 1.00 | 0.60 | | | 0.91 | 0.90 | 0.82 | 0.69 |
| | 22 (559) | 1.00 | 0.91 | 0.74 | | | 0.98 | 0.72 | 0.68 | 0.63 | | | 0.69 | | | 0.98 | 0.95 | 0.86 | 0.72 |
| | 24 (610) | | 0.94 | 0.77 | | | 1.00 | 0.74 | 0.70 | 0.64 | | | 0.79 | | | 1.00 | 0.99 | 0.89 | 0.75 |
| | 26 (660) | | 0.98 | 0.79 | | | | 0.76 | 0.72 | 0.65 | | | 0.89 | | | | 1.00 | 0.93 | 0.78 |
| | 28 (711) | | 1.00 | 0.81 | | | | 0.79 | 0.73 | 0.67 | | | 0.99 | | | | | 0.97 | 0.81 |
| 30 (762) | | | 0.83 | | | | 0.81 | 0.75 | 0.68 | | | 1.00 | | | | | 1.00 | 0.84 | |
| 36 (914) | | | 0.90 | | | | 0.87 | 0.80 | 0.71 | | | | | | | | | 0.92 | |
| > 48 (1219) | | | 1.00 | | | | 0.99 | 0.90 | 0.78 | | | | | | | | | 1.00 | |

1 Linear interpolation not permitted

2 Shaded area with reduced edge distance is permitted provided the rebar has no installation torque.

3 When combining multiple load adjustment factors (e.g. for a four-anchor pattern in a corner with thin concrete member) the design can become very conservative. To optimize the design, use Hilti PROFIS Anchor Design software or perform anchor calculation using design equations from ACI 318 Chapter 17.

4 Spacing factor reduction in shear applicable when $c_a < 3 \cdot h_{ef}$, f_{AV} is applicable when edge distance, $c_a < 3 \cdot h_{ef}$. If $c_a \geq 3 \cdot h_{ef}$, then $f_{AV} = f_{AN}$.

5 Concrete thickness reduction factor in shear, f_{HV} , is applicable when edge distance, $c_a < 3 \cdot h_{ef}$. If $c_a \geq 3 \cdot h_{ef}$, then $f_{HV} = 1.0$.

Table 12 – Load adjustment factors for #7 rebar in uncracked concrete ^{1,2,3}

| #7 Uncracked concrete | Spacing factor in tension f_{AN} | | | Edge distance factor in tension f_{RN} | | | Spacing factor in shear ⁴ f_{AV} | | | Edge distance in shear | | | | | | Concrete thickness factor in shear ⁵ f_{HV} | | | | |
|---|---------------------------------------|------|------|---|-----------------|-----------------|--|-----------------|-----------------|------------------------|-----------------|-----------------|------------------------------|------|------|---|------|------|----------------|-----------------|
| | Embedment h_{ef} in (mm) | | | 7-7/8 (200) | 10-1/2 (267) | 17-1/2 (445) | 7-7/8 (200) | 10-1/2 (267) | 17-1/2 (445) | 7-7/8 (200) | 10-1/2 (267) | 17-1/2 (445) | ⊥ Toward edge f_{RV} | | | ∥ To edge f_{RV} | | | 7-7/8 (200) | 10-1/2 (267) |
| Spacing (s) / edge distance (c_a) / concrete thickness (h_c), - in (mm) | 1-3/4 (44) | n/a | n/a | n/a | 0.23 | 0.17 | 0.10 | n/a | n/a | n/a | 0.03 | 0.02 | 0.01 | 0.05 | 0.04 | 0.02 | n/a | n/a | n/a | |
| | 4-3/8 (111) | 0.59 | 0.57 | 0.54 | 0.32 | 0.23 | 0.14 | 0.54 | 0.53 | 0.52 | 0.11 | 0.08 | 0.05 | 0.22 | 0.16 | 0.10 | n/a | n/a | n/a | |
| | 5 (127) | 0.61 | 0.58 | 0.55 | 0.34 | 0.25 | 0.15 | 0.54 | 0.54 | 0.53 | 0.13 | 0.10 | 0.06 | 0.27 | 0.20 | 0.12 | n/a | n/a | n/a | |
| | 6 (152) | 0.63 | 0.60 | 0.56 | 0.37 | 0.28 | 0.16 | 0.55 | 0.54 | 0.53 | 0.17 | 0.13 | 0.08 | 0.35 | 0.26 | 0.16 | n/a | n/a | n/a | |
| | 7 (178) | 0.65 | 0.61 | 0.57 | 0.41 | 0.30 | 0.18 | 0.56 | 0.55 | 0.54 | 0.22 | 0.16 | 0.10 | 0.41 | 0.30 | 0.18 | n/a | n/a | n/a | |
| | 8 (203) | 0.67 | 0.63 | 0.58 | 0.45 | 0.33 | 0.19 | 0.57 | 0.56 | 0.54 | 0.27 | 0.20 | 0.12 | 0.45 | 0.33 | 0.19 | n/a | n/a | n/a | |
| | 9-7/8 (251) | 0.71 | 0.66 | 0.59 | 0.53 | 0.39 | 0.23 | 0.59 | 0.57 | 0.55 | 0.37 | 0.28 | 0.17 | 0.53 | 0.39 | 0.23 | 0.59 | n/a | n/a | |
| | 10 (254) | 0.71 | 0.66 | 0.60 | 0.54 | 0.40 | 0.23 | 0.59 | 0.57 | 0.55 | 0.38 | 0.28 | 0.17 | 0.54 | 0.40 | 0.23 | 0.59 | n/a | n/a | |
| | 12 (305) | 0.75 | 0.69 | 0.61 | 0.65 | 0.48 | 0.28 | 0.60 | 0.59 | 0.56 | 0.49 | 0.37 | 0.22 | 0.65 | 0.48 | 0.28 | 0.65 | n/a | n/a | |
| | 12-1/2 (318) | 0.76 | 0.70 | 0.62 | 0.67 | 0.50 | 0.29 | 0.61 | 0.59 | 0.56 | 0.52 | 0.39 | 0.24 | 0.67 | 0.50 | 0.29 | 0.66 | 0.60 | n/a | |
| | 14 (356) | 0.80 | 0.72 | 0.63 | 0.75 | 0.55 | 0.33 | 0.62 | 0.60 | 0.57 | 0.62 | 0.46 | 0.28 | 0.75 | 0.55 | 0.33 | 0.70 | 0.63 | n/a | |
| | 16 (406) | 0.84 | 0.75 | 0.65 | 0.86 | 0.63 | 0.37 | 0.64 | 0.61 | 0.58 | 0.76 | 0.57 | 0.34 | 0.86 | 0.63 | 0.37 | 0.75 | 0.68 | n/a | |
| | 18 (457) | 0.88 | 0.79 | 0.67 | 0.97 | 0.71 | 0.42 | 0.66 | 0.63 | 0.59 | 0.91 | 0.68 | 0.41 | 0.97 | 0.71 | 0.42 | 0.79 | 0.72 | n/a | |
| | 19-1/2 (495) | 0.91 | 0.81 | 0.69 | 1.00 | 0.77 | 0.45 | 0.67 | 0.64 | 0.60 | 1.00 | 0.76 | 0.46 | 1.00 | 0.77 | 0.45 | 0.82 | 0.75 | 0.63 | |
| | 20 (508) | 0.92 | 0.82 | 0.69 | | 0.79 | 0.46 | 0.67 | 0.64 | 0.60 | | 0.79 | 0.48 | | 0.79 | 0.46 | 0.83 | 0.76 | 0.64 | |
| | 22 (559) | 0.97 | 0.85 | 0.71 | | 0.87 | 0.51 | 0.69 | 0.66 | 0.61 | | 0.92 | 0.55 | | 0.87 | 0.51 | 0.87 | 0.79 | 0.67 | |
| | 24 (610) | 1.00 | 0.88 | 0.73 | | 0.95 | 0.56 | 0.71 | 0.67 | 0.62 | | 1.00 | 0.63 | | 0.95 | 0.56 | 0.91 | 0.83 | 0.70 | |
| | 26 (660) | | 0.91 | 0.75 | | 1.00 | 0.60 | 0.73 | 0.69 | 0.63 | | | 0.71 | | 1.00 | 0.60 | 0.95 | 0.86 | 0.73 | |
| | 28 (711) | | 0.94 | 0.77 | | | 0.65 | 0.74 | 0.70 | 0.64 | | | 0.79 | | | 0.65 | 0.99 | 0.89 | 0.75 | |
| 30 (762) | | 0.98 | 0.79 | | | 0.70 | 0.76 | 0.71 | 0.65 | | | 0.87 | | | 0.70 | 1.00 | 0.93 | 0.78 | | |
| 36 (914) | | 1.00 | 0.84 | | | 0.84 | 0.81 | 0.76 | 0.68 | | | 1.00 | | | 0.84 | | 1.00 | 0.86 | | |
| > 48 (1219) | | | 0.96 | | | 1.00 | 0.92 | 0.84 | 0.74 | | | | | | 1.00 | | | 0.99 | | |

Table 13 – Load adjustment factors for #7 rebar in cracked concrete ^{1,2,3}

| #7 Cracked concrete | Spacing factor in tension f_{AN} | | | Edge distance factor in tension f_{RN} | | | Spacing factor in shear ⁴ f_{AV} | | | Edge distance in shear | | | | | | Concrete thickness factor in shear ⁵ f_{HV} | | | | |
|---|---------------------------------------|------|------|---|-----------------|-----------------|--|-----------------|-----------------|------------------------|-----------------|-----------------|------------------------------|------|------|---|------|------|----------------|-----------------|
| | Embedment h_{ef} in (mm) | | | 7-7/8 (200) | 10-1/2 (267) | 17-1/2 (445) | 7-7/8 (200) | 10-1/2 (267) | 17-1/2 (445) | 7-7/8 (200) | 10-1/2 (267) | 17-1/2 (445) | ⊥ Toward edge f_{RV} | | | ∥ To edge f_{RV} | | | 7-7/8 (200) | 10-1/2 (267) |
| Spacing (s) / edge distance (c_a) / concrete thickness (h_c), - in (mm) | 1-3/4 (44) | n/a | n/a | n/a | 0.43 | 0.41 | 0.38 | n/a | n/a | n/a | 0.03 | 0.02 | 0.01 | 0.06 | 0.05 | 0.03 | n/a | n/a | n/a | |
| | 4-3/8 (111) | 0.59 | 0.57 | 0.54 | 0.56 | 0.50 | 0.44 | 0.54 | 0.53 | 0.52 | 0.12 | 0.09 | 0.05 | 0.24 | 0.18 | 0.11 | n/a | n/a | n/a | |
| | 5 (127) | 0.61 | 0.58 | 0.55 | 0.59 | 0.52 | 0.45 | 0.55 | 0.54 | 0.53 | 0.15 | 0.11 | 0.07 | 0.29 | 0.22 | 0.13 | n/a | n/a | n/a | |
| | 6 (152) | 0.63 | 0.60 | 0.56 | 0.64 | 0.56 | 0.47 | 0.56 | 0.55 | 0.53 | 0.19 | 0.14 | 0.09 | 0.38 | 0.29 | 0.17 | n/a | n/a | n/a | |
| | 7 (178) | 0.65 | 0.61 | 0.57 | 0.70 | 0.60 | 0.49 | 0.56 | 0.55 | 0.54 | 0.24 | 0.18 | 0.11 | 0.48 | 0.36 | 0.22 | n/a | n/a | n/a | |
| | 8 (203) | 0.67 | 0.63 | 0.58 | 0.76 | 0.64 | 0.52 | 0.57 | 0.56 | 0.54 | 0.29 | 0.22 | 0.13 | 0.59 | 0.44 | 0.26 | n/a | n/a | n/a | |
| | 9-7/8 (251) | 0.71 | 0.66 | 0.59 | 0.87 | 0.72 | 0.56 | 0.59 | 0.58 | 0.55 | 0.40 | 0.30 | 0.18 | 0.81 | 0.60 | 0.36 | 0.60 | n/a | n/a | |
| | 10 (254) | 0.71 | 0.66 | 0.60 | 0.88 | 0.73 | 0.56 | 0.59 | 0.58 | 0.55 | 0.41 | 0.31 | 0.18 | 0.82 | 0.62 | 0.37 | 0.61 | n/a | n/a | |
| | 12 (305) | 0.75 | 0.69 | 0.61 | 1.00 | 0.82 | 0.61 | 0.61 | 0.59 | 0.56 | 0.54 | 0.41 | 0.24 | 1.00 | 0.81 | 0.49 | 0.66 | n/a | n/a | |
| | 12-1/2 (318) | 0.76 | 0.70 | 0.62 | | 0.84 | 0.62 | 0.62 | 0.60 | 0.57 | 0.57 | 0.43 | 0.26 | 1.00 | 0.84 | 0.52 | 0.68 | 0.62 | n/a | |
| | 14 (356) | 0.80 | 0.72 | 0.63 | | 0.91 | 0.66 | 0.63 | 0.61 | 0.58 | 0.68 | 0.51 | 0.31 | | 0.91 | 0.61 | 0.72 | 0.65 | n/a | |
| | 16 (406) | 0.84 | 0.75 | 0.65 | | 1.00 | 0.71 | 0.65 | 0.62 | 0.59 | 0.83 | 0.62 | 0.37 | | 1.00 | 0.71 | 0.77 | 0.70 | n/a | |
| | 18 (457) | 0.88 | 0.79 | 0.67 | | | 0.76 | 0.67 | 0.64 | 0.60 | 0.99 | 0.74 | 0.45 | | | 0.76 | 0.81 | 0.74 | n/a | |
| | 19-1/2 (495) | 0.91 | 0.81 | 0.69 | | | 0.80 | 0.68 | 0.65 | 0.61 | 1.00 | 0.84 | 0.50 | | | 0.80 | 0.85 | 0.77 | 0.65 | |
| | 20 (508) | 0.92 | 0.82 | 0.69 | | | 0.82 | 0.68 | 0.65 | 0.61 | | 0.87 | 0.52 | | | 0.82 | 0.86 | 0.78 | 0.66 | |
| | 22 (559) | 0.97 | 0.85 | 0.71 | | | 0.87 | 0.70 | 0.67 | 0.62 | | 1.00 | 0.60 | | | 0.87 | 0.90 | 0.82 | 0.69 | |
| | 24 (610) | 1.00 | 0.88 | 0.73 | | | 0.93 | 0.72 | 0.68 | 0.63 | | | 0.69 | | | 0.93 | 0.94 | 0.85 | 0.72 | |
| | 26 (660) | | 0.91 | 0.75 | | | 0.99 | 0.74 | 0.70 | 0.64 | | | 0.78 | | | 0.99 | 0.98 | 0.89 | 0.75 | |
| | 28 (711) | | 0.94 | 0.77 | | | 1.00 | 0.76 | 0.71 | 0.65 | | | 0.87 | | | 1.00 | 1.00 | 0.92 | 0.78 | |
| 30 (762) | | 0.98 | 0.79 | | | | 0.78 | 0.73 | 0.66 | | | 0.96 | | | | | 0.96 | 0.81 | | |
| 36 (914) | | 1.00 | 0.84 | | | | 0.83 | 0.77 | 0.69 | | | 1.00 | | | | | 1.00 | 0.88 | | |
| > 48 (1219) | | | 0.96 | | | | 0.94 | 0.86 | 0.76 | | | | | | | | | 1.00 | | |

1 Linear interpolation not permitted

2 Shaded area with reduced edge distance is permitted provided the rebar has no installation torque.

3 When combining multiple load adjustment factors (e.g. for a four-anchor pattern in a corner with thin concrete member) the design can become very conservative. To optimize the design, use Hilti PROFIS Anchor Design software or perform anchor calculation using design equations from ACI 318 Chapter 17.

4 Spacing factor reduction in shear applicable when $c_a < 3 \cdot h_{ef}$. f_{AV} is applicable when edge distance, $c_a < 3 \cdot h_{ef}$. If $c_a \geq 3 \cdot h_{ef}$, then $f_{AV} = f_{AN}$.

5 Concrete thickness reduction factor in shear, f_{HV} , is applicable when edge distance, $c_a < 3 \cdot h_{ef}$. If $c_a \geq 3 \cdot h_{ef}$, then $f_{HV} = 1.0$.

Table 14 – Load adjustment factors for #8 rebar in uncracked concrete ^{1,2,3}

| #8 Uncracked concrete | Spacing factor in tension f_{AN} | | | Edge distance factor in tension f_{RN} | | | Spacing factor in shear ⁴ f_{AV} | | | Edge distance in shear | | | | | | Concrete thickness factor in shear ⁵ f_{HV} | | | |
|---|--|-------------|-------------|--|-------------|-------------|---|-------------|-------------|------------------------------|-------------|-------------|--------------------------|-------------|-------------|--|-------------|-------------|------|
| | Toward edge f_{RV} | | | To edge f_{RV} | | | | | | ⊥ Toward edge f_{RV} | | | ∥ To edge f_{RV} | | | | | | |
| Embedment h_{ef} in (mm) | 9 (229) | 12 (305) | 20 (508) | 9 (229) | 12 (305) | 20 (508) | 9 (229) | 12 (305) | 20 (508) | 9 (229) | 12 (305) | 20 (508) | 9 (229) | 12 (305) | 20 (508) | 9 (229) | 12 (305) | 20 (508) | |
| Spacing (s) / edge distance (c_e) / concrete thickness (h), - in (mm) | 1-3/4 (44) | n/a | n/a | n/a | 0.23 | 0.17 | 0.10 | n/a | n/a | n/a | 0.02 | 0.02 | 0.01 | 0.05 | 0.03 | 0.02 | n/a | n/a | n/a |
| | 5 (127) | 0.59 | 0.57 | 0.54 | 0.32 | 0.23 | 0.14 | 0.54 | 0.53 | 0.52 | 0.11 | 0.08 | 0.05 | 0.22 | 0.15 | 0.09 | n/a | n/a | n/a |
| | 6 (152) | 0.61 | 0.58 | 0.55 | 0.35 | 0.26 | 0.15 | 0.55 | 0.54 | 0.53 | 0.14 | 0.10 | 0.06 | 0.29 | 0.20 | 0.12 | n/a | n/a | n/a |
| | 7 (178) | 0.63 | 0.60 | 0.56 | 0.38 | 0.28 | 0.16 | 0.55 | 0.54 | 0.53 | 0.18 | 0.13 | 0.08 | 0.36 | 0.25 | 0.15 | n/a | n/a | n/a |
| | 8 (203) | 0.65 | 0.61 | 0.57 | 0.41 | 0.30 | 0.18 | 0.56 | 0.55 | 0.53 | 0.22 | 0.15 | 0.09 | 0.41 | 0.30 | 0.18 | n/a | n/a | n/a |
| | 9 (229) | 0.67 | 0.63 | 0.58 | 0.45 | 0.33 | 0.19 | 0.57 | 0.55 | 0.54 | 0.26 | 0.18 | 0.11 | 0.45 | 0.33 | 0.19 | n/a | n/a | n/a |
| | 10 (254) | 0.69 | 0.64 | 0.58 | 0.48 | 0.36 | 0.21 | 0.58 | 0.56 | 0.54 | 0.31 | 0.22 | 0.13 | 0.48 | 0.36 | 0.21 | n/a | n/a | n/a |
| | 11-1/4 (286) | 0.71 | 0.66 | 0.59 | 0.53 | 0.39 | 0.23 | 0.59 | 0.57 | 0.55 | 0.37 | 0.26 | 0.16 | 0.53 | 0.39 | 0.23 | 0.58 | n/a | n/a |
| | 12 (305) | 0.72 | 0.67 | 0.60 | 0.57 | 0.42 | 0.24 | 0.59 | 0.57 | 0.55 | 0.40 | 0.28 | 0.17 | 0.57 | 0.42 | 0.24 | 0.60 | n/a | n/a |
| | 14 (356) | 0.76 | 0.69 | 0.62 | 0.66 | 0.49 | 0.29 | 0.61 | 0.58 | 0.56 | 0.51 | 0.36 | 0.22 | 0.66 | 0.49 | 0.29 | 0.65 | n/a | n/a |
| | 14-1/4 (362) | 0.76 | 0.70 | 0.62 | 0.67 | 0.50 | 0.29 | 0.61 | 0.59 | 0.56 | 0.52 | 0.37 | 0.22 | 0.67 | 0.50 | 0.29 | 0.66 | 0.59 | n/a |
| | 16 (406) | 0.80 | 0.72 | 0.63 | 0.76 | 0.56 | 0.33 | 0.62 | 0.60 | 0.57 | 0.62 | 0.44 | 0.26 | 0.76 | 0.56 | 0.33 | 0.70 | 0.62 | n/a |
| | 18 (457) | 0.83 | 0.75 | 0.65 | 0.85 | 0.63 | 0.37 | 0.64 | 0.61 | 0.58 | 0.74 | 0.52 | 0.31 | 0.85 | 0.63 | 0.37 | 0.74 | 0.66 | n/a |
| | 20 (508) | 0.87 | 0.78 | 0.67 | 0.95 | 0.70 | 0.41 | 0.65 | 0.62 | 0.59 | 0.87 | 0.61 | 0.37 | 0.95 | 0.70 | 0.41 | 0.78 | 0.69 | n/a |
| | 22 (559) | 0.91 | 0.81 | 0.68 | 1.00 | 0.76 | 0.45 | 0.67 | 0.63 | 0.59 | 1.00 | 0.71 | 0.42 | 1.00 | 0.76 | 0.45 | 0.82 | 0.73 | n/a |
| | 22-1/4 (565) | 0.91 | 0.81 | 0.69 | | 0.77 | 0.45 | 0.67 | 0.63 | 0.60 | | 0.72 | 0.43 | | 0.77 | 0.45 | 0.82 | 0.73 | 0.62 |
| | 24 (610) | 0.94 | 0.83 | 0.70 | | 0.83 | 0.49 | 0.68 | 0.64 | 0.60 | | 0.81 | 0.48 | | 0.83 | 0.49 | 0.85 | 0.76 | 0.64 |
| | 26 (660) | 0.98 | 0.86 | 0.72 | | 0.90 | 0.53 | 0.70 | 0.66 | 0.61 | | 0.91 | 0.54 | | 0.90 | 0.53 | 0.89 | 0.79 | 0.67 |
| | 28 (711) | 1.00 | 0.89 | 0.73 | | 0.97 | 0.57 | 0.71 | 0.67 | 0.62 | | 1.00 | 0.61 | | 0.97 | 0.57 | 0.92 | 0.82 | 0.69 |
| | 30 (762) | | 0.92 | 0.75 | | 1.00 | 0.61 | 0.73 | 0.68 | 0.63 | | | 0.68 | | 1.00 | 0.61 | 0.95 | 0.85 | 0.72 |
| 36 (914) | | 1.00 | 0.80 | | | 0.73 | 0.77 | 0.72 | 0.65 | | | 0.89 | | | 0.73 | 1.00 | 0.93 | 0.78 | |
| > 48 (1219) | | | 0.90 | | | 0.98 | 0.86 | 0.79 | 0.71 | | | 1.00 | | | 0.98 | | 1.00 | 0.91 | |

Table 15 – Load adjustment factors for #8 rebar in cracked concrete ^{1,2,3}

| #8 Cracked concrete | Spacing factor in tension f_{AN} | | | Edge distance factor in tension f_{RN} | | | Spacing factor in shear ⁴ f_{AV} | | | Edge distance in shear | | | | | | Concrete thickness factor in shear ⁵ f_{HV} | | | |
|---|--|-------------|-------------|--|-------------|-------------|---|-------------|-------------|------------------------------|-------------|-------------|--------------------------|-------------|-------------|--|-------------|-------------|------|
| | Toward edge f_{RV} | | | To edge f_{RV} | | | | | | ⊥ Toward edge f_{RV} | | | ∥ To edge f_{RV} | | | | | | |
| Embedment h_{ef} in (mm) | 9 (229) | 12 (305) | 20 (508) | 9 (229) | 12 (305) | 20 (508) | 9 (229) | 12 (305) | 20 (508) | 9 (229) | 12 (305) | 20 (508) | 9 (229) | 12 (305) | 20 (508) | 9 (229) | 12 (305) | 20 (508) | |
| Spacing (s) / edge distance (c_e) / concrete thickness (h), - in (mm) | 1-3/4 (44) | n/a | n/a | n/a | 0.42 | 0.40 | 0.38 | n/a | n/a | n/a | 0.02 | 0.02 | 0.01 | 0.05 | 0.03 | 0.02 | n/a | n/a | n/a |
| | 5 (127) | 0.59 | 0.57 | 0.54 | 0.56 | 0.50 | 0.44 | 0.54 | 0.53 | 0.52 | 0.11 | 0.08 | 0.05 | 0.22 | 0.17 | 0.10 | n/a | n/a | n/a |
| | 6 (152) | 0.61 | 0.58 | 0.55 | 0.60 | 0.53 | 0.46 | 0.55 | 0.54 | 0.53 | 0.15 | 0.11 | 0.07 | 0.29 | 0.22 | 0.13 | n/a | n/a | n/a |
| | 7 (178) | 0.63 | 0.60 | 0.56 | 0.65 | 0.57 | 0.47 | 0.55 | 0.54 | 0.53 | 0.18 | 0.14 | 0.08 | 0.37 | 0.28 | 0.17 | n/a | n/a | n/a |
| | 8 (203) | 0.65 | 0.61 | 0.57 | 0.70 | 0.60 | 0.49 | 0.56 | 0.55 | 0.54 | 0.23 | 0.17 | 0.10 | 0.45 | 0.34 | 0.20 | n/a | n/a | n/a |
| | 9 (229) | 0.67 | 0.63 | 0.58 | 0.75 | 0.64 | 0.51 | 0.57 | 0.56 | 0.54 | 0.27 | 0.20 | 0.12 | 0.54 | 0.40 | 0.24 | n/a | n/a | n/a |
| | 10 (254) | 0.69 | 0.64 | 0.58 | 0.80 | 0.67 | 0.53 | 0.58 | 0.56 | 0.55 | 0.31 | 0.24 | 0.14 | 0.63 | 0.47 | 0.28 | n/a | n/a | n/a |
| | 11-1/4 (286) | 0.71 | 0.66 | 0.59 | 0.87 | 0.72 | 0.56 | 0.59 | 0.57 | 0.55 | 0.38 | 0.28 | 0.17 | 0.75 | 0.56 | 0.34 | 0.59 | n/a | n/a |
| | 12 (305) | 0.72 | 0.67 | 0.60 | 0.91 | 0.75 | 0.57 | 0.59 | 0.58 | 0.55 | 0.41 | 0.31 | 0.19 | 0.83 | 0.62 | 0.37 | 0.61 | n/a | n/a |
| | 14 (356) | 0.76 | 0.69 | 0.62 | 1.00 | 0.83 | 0.62 | 0.61 | 0.59 | 0.56 | 0.52 | 0.39 | 0.23 | 1.00 | 0.78 | 0.47 | 0.66 | n/a | n/a |
| | 14-1/4 (362) | 0.76 | 0.70 | 0.62 | | 0.84 | 0.62 | 0.61 | 0.59 | 0.56 | 0.54 | 0.40 | 0.24 | | 0.80 | 0.48 | 0.66 | 0.60 | n/a |
| | 16 (406) | 0.80 | 0.72 | 0.63 | | 0.91 | 0.66 | 0.62 | 0.60 | 0.57 | 0.64 | 0.48 | 0.29 | | 0.91 | 0.57 | 0.70 | 0.64 | n/a |
| | 18 (457) | 0.83 | 0.75 | 0.65 | | 1.00 | 0.70 | 0.64 | 0.61 | 0.58 | 0.76 | 0.57 | 0.34 | | 1.00 | 0.68 | 0.75 | 0.68 | n/a |
| | 20 (508) | 0.87 | 0.78 | 0.67 | | | 0.75 | 0.65 | 0.63 | 0.59 | 0.89 | 0.67 | 0.40 | | | 0.75 | 0.79 | 0.71 | n/a |
| | 22 (559) | 0.91 | 0.81 | 0.68 | | | 0.80 | 0.67 | 0.64 | 0.60 | 1.00 | 0.77 | 0.46 | | | 0.80 | 0.82 | 0.75 | n/a |
| | 22-1/4 (565) | 0.91 | 0.81 | 0.69 | | | 0.80 | 0.67 | 0.64 | 0.60 | | 0.78 | 0.47 | | | 0.80 | 0.83 | 0.75 | 0.63 |
| | 24 (610) | 0.94 | 0.83 | 0.70 | | | 0.85 | 0.69 | 0.65 | 0.61 | | 0.88 | 0.53 | | | 0.85 | 0.86 | 0.78 | 0.66 |
| | 26 (660) | 0.98 | 0.86 | 0.72 | | | 0.90 | 0.70 | 0.67 | 0.62 | | 0.99 | 0.59 | | | 0.90 | 0.90 | 0.81 | 0.69 |
| | 28 (711) | 1.00 | 0.89 | 0.73 | | | 0.95 | 0.72 | 0.68 | 0.63 | | 1.00 | 0.66 | | | 0.95 | 0.93 | 0.84 | 0.71 |
| | 30 (762) | | 0.92 | 0.75 | | | 1.00 | 0.73 | 0.69 | 0.64 | | | 0.74 | | | 1.00 | 0.96 | 0.87 | 0.74 |
| 36 (914) | | 1.00 | 0.80 | | | | 0.78 | 0.73 | 0.66 | | | 0.97 | | | 1.00 | 0.96 | 0.81 | | |
| > 48 (1219) | | | 0.90 | | | | 0.87 | 0.81 | 0.72 | | | 1.00 | | | | 1.00 | 0.93 | | |

1 Linear interpolation not permitted
 2 Shaded area with reduced edge distance is permitted provided the rebar has no installation torque.
 3 When combining multiple load adjustment factors (e.g. for a four-anchor pattern in a corner with thin concrete member) the design can become very conservative. To optimize the design, use Hilti PROFIS Anchor Design software or perform anchor calculation using design equations from ACI 318 Chapter 17.
 4 Spacing factor reduction in shear applicable when $c_e < 3 \cdot h_{ef}$, f_{AV} is applicable when edge distance, $c_e < 3 \cdot h_{ef}$. If $c_e \geq 3 \cdot h_{ef}$, then $f_{AV} = f_{AN}$.
 5 Concrete thickness reduction factor in shear, f_{HV} , is applicable when edge distance, $c_e < 3 \cdot h_{ef}$. If $c_e \geq 3 \cdot h_{ef}$, then $f_{HV} = 1.0$.

Table 16 – Load adjustment factors for #9 rebar in uncracked concrete^{1,2,3}

| | #9 Uncracked concrete | Spacing factor in tension f_{AN} | | | Edge distance factor in tension f_{RN} | | | Spacing factor in shear ⁴ f_{AV} | | | Edge distance in shear | | | | | | Concrete thickness factor in shear ⁵ f_{HV} | | |
|---|--------------------------|---------------------------------------|-----------------|-----------------|---|-----------------|-----------------|--|-----------------|-----------------|------------------------------|-----------------|-----------------|--------------------------|-----------------|-----------------|---|-----------------|-----------------|
| | | | | | | | | | | | ⊥ Toward edge f_{RV} | | | ∥ To edge f_{RV} | | | | | |
| | | Embedment h_{ef} in (mm) | 10-1/8 (257) | 13-1/2 (343) | 22-1/2 (572) | 10-1/8 (257) | 13-1/2 (343) | 22-1/2 (572) | 10-1/8 (257) | 13-1/2 (343) | 22-1/2 (572) | 10-1/8 (257) | 13-1/2 (343) | 22-1/2 (572) | 10-1/8 (257) | 13-1/2 (343) | 22-1/2 (572) | 10-1/8 (257) | 13-1/2 (343) |
| Spacing (s) / edge distance (c_a) / concrete thickness (h_c), - in (mm) | 1-3/4 (44) | n/a | n/a | n/a | 0.22 | 0.16 | 0.10 | n/a | n/a | n/a | 0.02 | 0.01 | 0.01 | 0.04 | 0.03 | 0.02 | n/a | n/a | n/a |
| | 5-5/8 (143) | 0.59 | 0.57 | 0.54 | 0.32 | 0.24 | 0.14 | 0.54 | 0.53 | 0.52 | 0.11 | 0.08 | 0.05 | 0.22 | 0.15 | 0.09 | n/a | n/a | n/a |
| | 6 (152) | 0.60 | 0.57 | 0.54 | 0.33 | 0.24 | 0.14 | 0.54 | 0.53 | 0.52 | 0.12 | 0.08 | 0.05 | 0.24 | 0.17 | 0.10 | n/a | n/a | n/a |
| | 7 (178) | 0.62 | 0.59 | 0.55 | 0.36 | 0.26 | 0.15 | 0.55 | 0.54 | 0.53 | 0.15 | 0.11 | 0.06 | 0.30 | 0.21 | 0.13 | n/a | n/a | n/a |
| | 8 (203) | 0.63 | 0.60 | 0.56 | 0.39 | 0.29 | 0.17 | 0.55 | 0.54 | 0.53 | 0.18 | 0.13 | 0.08 | 0.37 | 0.26 | 0.16 | n/a | n/a | n/a |
| | 9 (229) | 0.65 | 0.61 | 0.57 | 0.42 | 0.31 | 0.18 | 0.56 | 0.55 | 0.53 | 0.22 | 0.16 | 0.09 | 0.42 | 0.31 | 0.18 | n/a | n/a | n/a |
| | 10 (254) | 0.66 | 0.62 | 0.57 | 0.45 | 0.33 | 0.19 | 0.57 | 0.55 | 0.54 | 0.26 | 0.18 | 0.11 | 0.45 | 0.33 | 0.19 | n/a | n/a | n/a |
| | 12 (305) | 0.70 | 0.65 | 0.59 | 0.52 | 0.38 | 0.22 | 0.58 | 0.56 | 0.55 | 0.34 | 0.24 | 0.14 | 0.52 | 0.38 | 0.22 | n/a | n/a | n/a |
| | 12-7/8 (327) | 0.71 | 0.66 | 0.60 | 0.56 | 0.41 | 0.24 | 0.59 | 0.57 | 0.55 | 0.38 | 0.27 | 0.16 | 0.56 | 0.41 | 0.24 | 0.59 | n/a | n/a |
| | 14 (356) | 0.73 | 0.67 | 0.60 | 0.61 | 0.45 | 0.26 | 0.59 | 0.57 | 0.55 | 0.43 | 0.30 | 0.18 | 0.61 | 0.45 | 0.26 | 0.61 | n/a | n/a |
| | 16 (406) | 0.76 | 0.70 | 0.62 | 0.69 | 0.51 | 0.30 | 0.61 | 0.59 | 0.56 | 0.52 | 0.37 | 0.22 | 0.69 | 0.51 | 0.30 | 0.66 | n/a | n/a |
| | 16-1/4 (413) | 0.77 | 0.70 | 0.62 | 0.70 | 0.52 | 0.30 | 0.61 | 0.59 | 0.56 | 0.53 | 0.38 | 0.23 | 0.70 | 0.52 | 0.30 | 0.66 | 0.59 | n/a |
| | 18 (457) | 0.80 | 0.72 | 0.63 | 0.78 | 0.57 | 0.33 | 0.62 | 0.60 | 0.57 | 0.62 | 0.44 | 0.26 | 0.78 | 0.57 | 0.33 | 0.70 | 0.62 | n/a |
| | 20 (508) | 0.83 | 0.75 | 0.65 | 0.87 | 0.64 | 0.37 | 0.63 | 0.61 | 0.58 | 0.73 | 0.51 | 0.31 | 0.87 | 0.64 | 0.37 | 0.73 | 0.65 | n/a |
| | 22 (559) | 0.86 | 0.77 | 0.66 | 0.95 | 0.70 | 0.41 | 0.65 | 0.62 | 0.58 | 0.84 | 0.59 | 0.36 | 0.95 | 0.70 | 0.41 | 0.77 | 0.69 | n/a |
| | 24 (610) | 0.90 | 0.80 | 0.68 | 1.00 | 0.76 | 0.45 | 0.66 | 0.63 | 0.59 | 0.96 | 0.67 | 0.40 | 1.00 | 0.76 | 0.45 | 0.80 | 0.72 | n/a |
| | 25-1/4 (641) | 0.92 | 0.81 | 0.69 | | 0.80 | 0.47 | 0.67 | 0.63 | 0.60 | 1.00 | 0.73 | 0.44 | | 0.80 | 0.47 | 0.83 | 0.73 | 0.62 |
| | 26 (660) | 0.93 | 0.82 | 0.69 | | 0.83 | 0.48 | 0.68 | 0.64 | 0.60 | | 0.76 | 0.46 | | 0.83 | 0.48 | 0.84 | 0.75 | 0.63 |
| | 28 (711) | 0.96 | 0.85 | 0.71 | | 0.89 | 0.52 | 0.69 | 0.65 | 0.61 | | 0.85 | 0.51 | | 0.89 | 0.52 | 0.87 | 0.77 | 0.65 |
| | 30 (762) | 0.99 | 0.87 | 0.72 | | 0.95 | 0.56 | 0.70 | 0.66 | 0.61 | | 0.94 | 0.57 | | 0.95 | 0.56 | 0.90 | 0.80 | 0.68 |
| 36 (914) | 1.00 | 0.94 | 0.77 | | 1.00 | 0.67 | 0.74 | 0.69 | 0.64 | | 1.00 | 0.74 | | 1.00 | 0.67 | 0.99 | 0.88 | 0.74 | |
| > 48 (1219) | | 1.00 | 0.86 | | 1.00 | 0.89 | 0.82 | 0.76 | 0.68 | | | 1.00 | | | 0.89 | 1.00 | 1.00 | 0.85 | |

Table 17 – Load adjustment factors for #9 rebar in cracked concrete^{1,2,3}

| | #9 Cracked concrete | Spacing factor in tension f_{AN} | | | Edge distance factor in tension f_{RN} | | | Spacing factor in shear ⁴ f_{AV} | | | Edge distance in shear | | | | | | Concrete thickness factor in shear ⁵ f_{HV} | | |
|---|------------------------|---------------------------------------|-----------------|-----------------|---|-----------------|-----------------|--|-----------------|-----------------|------------------------------|-----------------|-----------------|--------------------------|-----------------|-----------------|---|-----------------|-----------------|
| | | | | | | | | | | | ⊥ Toward edge f_{RV} | | | ∥ To edge f_{RV} | | | | | |
| | | Embedment h_{ef} in (mm) | 10-1/8 (257) | 13-1/2 (343) | 22-1/2 (572) | 10-1/8 (257) | 13-1/2 (343) | 22-1/2 (572) | 10-1/8 (257) | 13-1/2 (343) | 22-1/2 (572) | 10-1/8 (257) | 13-1/2 (343) | 22-1/2 (572) | 10-1/8 (257) | 13-1/2 (343) | 22-1/2 (572) | 10-1/8 (257) | 13-1/2 (343) |
| Spacing (s) / edge distance (c_a) / concrete thickness (h_c), - in (mm) | 1-3/4 (44) | n/a | n/a | n/a | 0.41 | 0.39 | 0.38 | n/a | n/a | n/a | 0.02 | 0.01 | 0.01 | 0.04 | 0.03 | 0.02 | n/a | n/a | n/a |
| | 5-5/8 (143) | 0.59 | 0.57 | 0.54 | 0.56 | 0.50 | 0.44 | 0.54 | 0.53 | 0.52 | 0.11 | 0.08 | 0.05 | 0.22 | 0.16 | 0.09 | n/a | n/a | n/a |
| | 6 (152) | 0.60 | 0.57 | 0.54 | 0.57 | 0.51 | 0.44 | 0.54 | 0.53 | 0.52 | 0.12 | 0.09 | 0.05 | 0.24 | 0.17 | 0.10 | n/a | n/a | n/a |
| | 7 (178) | 0.62 | 0.59 | 0.55 | 0.61 | 0.54 | 0.46 | 0.55 | 0.54 | 0.53 | 0.15 | 0.11 | 0.07 | 0.30 | 0.22 | 0.13 | n/a | n/a | n/a |
| | 8 (203) | 0.63 | 0.60 | 0.56 | 0.65 | 0.57 | 0.48 | 0.55 | 0.54 | 0.53 | 0.19 | 0.13 | 0.08 | 0.37 | 0.27 | 0.16 | n/a | n/a | n/a |
| | 9 (229) | 0.65 | 0.61 | 0.57 | 0.70 | 0.60 | 0.49 | 0.56 | 0.55 | 0.53 | 0.22 | 0.16 | 0.10 | 0.44 | 0.32 | 0.19 | n/a | n/a | n/a |
| | 10 (254) | 0.66 | 0.62 | 0.57 | 0.74 | 0.63 | 0.51 | 0.57 | 0.55 | 0.54 | 0.26 | 0.19 | 0.11 | 0.52 | 0.37 | 0.22 | n/a | n/a | n/a |
| | 12 (305) | 0.70 | 0.65 | 0.59 | 0.84 | 0.70 | 0.55 | 0.58 | 0.57 | 0.55 | 0.34 | 0.25 | 0.15 | 0.68 | 0.49 | 0.29 | n/a | n/a | n/a |
| | 12-7/8 (327) | 0.71 | 0.66 | 0.60 | 0.88 | 0.73 | 0.56 | 0.59 | 0.57 | 0.55 | 0.38 | 0.27 | 0.16 | 0.76 | 0.54 | 0.33 | 0.59 | n/a | n/a |
| | 14 (356) | 0.73 | 0.67 | 0.60 | 0.94 | 0.77 | 0.58 | 0.60 | 0.58 | 0.55 | 0.43 | 0.31 | 0.19 | 0.86 | 0.62 | 0.37 | 0.62 | n/a | n/a |
| | 16 (406) | 0.76 | 0.70 | 0.62 | 1.00 | 0.84 | 0.62 | 0.61 | 0.59 | 0.56 | 0.53 | 0.38 | 0.23 | 1.00 | 0.75 | 0.45 | 0.66 | n/a | n/a |
| | 16-1/4 (413) | 0.77 | 0.70 | 0.62 | | 0.85 | 0.63 | 0.61 | 0.59 | 0.56 | 0.54 | 0.39 | 0.23 | | 0.77 | 0.46 | 0.66 | 0.59 | n/a |
| | 18 (457) | 0.80 | 0.72 | 0.63 | | 0.91 | 0.66 | 0.62 | 0.60 | 0.57 | 0.63 | 0.45 | 0.27 | | 0.90 | 0.54 | 0.70 | 0.63 | n/a |
| | 20 (508) | 0.83 | 0.75 | 0.65 | | 0.99 | 0.70 | 0.64 | 0.61 | 0.58 | 0.73 | 0.53 | 0.32 | | 0.99 | 0.63 | 0.74 | 0.66 | n/a |
| | 22 (559) | 0.86 | 0.77 | 0.66 | | 1.00 | 0.74 | 0.65 | 0.62 | 0.59 | 0.85 | 0.61 | 0.36 | | 1.00 | 0.73 | 0.77 | 0.69 | n/a |
| | 24 (610) | 0.90 | 0.80 | 0.68 | | | 0.78 | 0.66 | 0.63 | 0.59 | 0.97 | 0.69 | 0.42 | | | 0.78 | 0.81 | 0.72 | n/a |
| | 25-1/4 (641) | 0.92 | 0.81 | 0.69 | | | 0.81 | 0.67 | 0.64 | 0.60 | 1.00 | 0.75 | 0.45 | | | 0.81 | 0.83 | 0.74 | 0.63 |
| | 26 (660) | 0.93 | 0.82 | 0.69 | | | 0.82 | 0.68 | 0.64 | 0.60 | | 0.78 | 0.47 | | | 0.82 | 0.84 | 0.75 | 0.63 |
| | 28 (711) | 0.96 | 0.85 | 0.71 | | | 0.87 | 0.69 | 0.65 | 0.61 | | 0.87 | 0.52 | | | 0.87 | 0.87 | 0.78 | 0.66 |
| | 30 (762) | 0.99 | 0.87 | 0.72 | | | 0.91 | 0.70 | 0.66 | 0.62 | | 0.97 | 0.58 | | | 0.91 | 0.90 | 0.81 | 0.68 |
| 36 (914) | 1.00 | 0.94 | 0.77 | | | 1.00 | 0.74 | 0.70 | 0.64 | | 1.00 | 0.76 | | | 1.00 | 0.99 | 0.88 | 0.75 | |
| > 48 (1219) | | 1.00 | 0.86 | | | | 0.83 | 0.76 | 0.69 | | | 1.00 | | | | 1.00 | 1.00 | 0.86 | |

1 Linear interpolation not permitted

2 Shaded area with reduced edge distance is permitted provided the rebar has no installation torque.

3 When combining multiple load adjustment factors (e.g. for a four-anchor pattern in a corner with thin concrete member) the design can become very conservative. To optimize the design, use Hilti PROFIS Anchor Design software or perform anchor calculation using design equations from ACI 318 Chapter 17.

4 Spacing factor reduction in shear applicable when $c_a < 3 \cdot h_{ef}$. f_{AV} is applicable when edge distance, $c_a < 3 \cdot h_{ef}$. If $c_a \geq 3 \cdot h_{ef}$, then $f_{AV} = f_{AN}$.

5 Concrete thickness reduction factor in shear, f_{HV} , is applicable when edge distance, $c_a < 3 \cdot h_{ef}$. If $c_a \geq 3 \cdot h_{ef}$, then $f_{HV} = 1.0$.

Table 18 – Load adjustment factors for #10 rebar in uncracked concrete ^{1,2,3}

| Embedment h_{ef} in (mm) | #10 Uncracked concrete | Spacing factor in tension | | | Edge distance factor in tension | | | Spacing factor in shear ⁴ | | | Edge distance in shear | | | | | | Concrete thickness factor in shear ⁵ | | |
|-------------------------------|---------------------------|---------------------------|-------------|-------------|---------------------------------|-------------|-------------|--------------------------------------|-------------|-------------|------------------------------|-------------|-------------|--------------------------|-------------|-------------|---|-------------|-------------|
| | | f_{AN} | | | f_{RN} | | | f_{AV} | | | ⊥ Toward edge f_{RV} | | | ∥ To edge f_{RV} | | | f_{HV} | | |
| | | 11-1/4 (286) | 15 (381) | 25 (635) | 11-1/4 (286) | 15 (381) | 25 (635) | 11-1/4 (286) | 15 (381) | 25 (635) | 11-1/4 (286) | 15 (381) | 25 (635) | 11-1/4 (286) | 15 (381) | 25 (635) | 11-1/4 (286) | 15 (381) | 25 (635) |
| 1-3/4 (44) | n/a | n/a | n/a | 0.22 | 0.16 | 0.09 | n/a | n/a | n/a | 0.02 | 0.01 | 0.01 | 0.03 | 0.02 | 0.01 | n/a | n/a | n/a | |
| 6-1/4 (159) | 0.59 | 0.57 | 0.54 | 0.33 | 0.24 | 0.14 | 0.54 | 0.53 | 0.52 | 0.11 | 0.08 | 0.05 | 0.22 | 0.16 | 0.10 | n/a | n/a | n/a | |
| 7 (178) | 0.60 | 0.58 | 0.55 | 0.35 | 0.25 | 0.15 | 0.54 | 0.53 | 0.52 | 0.13 | 0.10 | 0.06 | 0.26 | 0.19 | 0.12 | n/a | n/a | n/a | |
| 8 (203) | 0.62 | 0.59 | 0.55 | 0.37 | 0.27 | 0.16 | 0.55 | 0.54 | 0.53 | 0.16 | 0.12 | 0.07 | 0.31 | 0.23 | 0.14 | n/a | n/a | n/a | |
| 9 (229) | 0.63 | 0.60 | 0.56 | 0.40 | 0.30 | 0.17 | 0.55 | 0.54 | 0.53 | 0.19 | 0.14 | 0.08 | 0.38 | 0.28 | 0.17 | n/a | n/a | n/a | |
| 10 (254) | 0.65 | 0.61 | 0.57 | 0.43 | 0.32 | 0.19 | 0.56 | 0.55 | 0.54 | 0.22 | 0.16 | 0.10 | 0.43 | 0.32 | 0.19 | n/a | n/a | n/a | |
| 11 (279) | 0.66 | 0.62 | 0.57 | 0.46 | 0.34 | 0.20 | 0.57 | 0.55 | 0.54 | 0.25 | 0.19 | 0.11 | 0.46 | 0.34 | 0.20 | n/a | n/a | n/a | |
| 12 (305) | 0.68 | 0.63 | 0.58 | 0.49 | 0.36 | 0.21 | 0.57 | 0.56 | 0.54 | 0.29 | 0.22 | 0.13 | 0.49 | 0.36 | 0.21 | n/a | n/a | n/a | |
| 14 (356) | 0.71 | 0.66 | 0.59 | 0.57 | 0.42 | 0.24 | 0.59 | 0.57 | 0.55 | 0.36 | 0.27 | 0.16 | 0.57 | 0.42 | 0.24 | n/a | n/a | n/a | |
| 14-1/4 (362) | 0.71 | 0.66 | 0.60 | 0.58 | 0.43 | 0.25 | 0.59 | 0.57 | 0.55 | 0.37 | 0.28 | 0.17 | 0.58 | 0.43 | 0.25 | 0.59 | n/a | n/a | |
| 16 (406) | 0.74 | 0.68 | 0.61 | 0.65 | 0.48 | 0.28 | 0.60 | 0.58 | 0.56 | 0.45 | 0.33 | 0.20 | 0.65 | 0.48 | 0.28 | 0.62 | n/a | n/a | |
| 17 (432) | 0.75 | 0.69 | 0.61 | 0.69 | 0.51 | 0.30 | 0.60 | 0.58 | 0.56 | 0.49 | 0.36 | 0.22 | 0.69 | 0.51 | 0.30 | 0.64 | n/a | n/a | |
| 18 (457) | 0.77 | 0.70 | 0.62 | 0.73 | 0.54 | 0.31 | 0.61 | 0.59 | 0.56 | 0.53 | 0.40 | 0.24 | 0.73 | 0.54 | 0.31 | 0.66 | 0.60 | n/a | |
| 20 (508) | 0.80 | 0.72 | 0.63 | 0.81 | 0.60 | 0.35 | 0.62 | 0.60 | 0.57 | 0.62 | 0.46 | 0.28 | 0.81 | 0.60 | 0.35 | 0.70 | 0.63 | n/a | |
| 22 (559) | 0.83 | 0.74 | 0.65 | 0.89 | 0.66 | 0.38 | 0.63 | 0.61 | 0.58 | 0.72 | 0.54 | 0.32 | 0.89 | 0.66 | 0.38 | 0.73 | 0.66 | n/a | |
| 24 (610) | 0.86 | 0.77 | 0.66 | 0.98 | 0.72 | 0.42 | 0.65 | 0.62 | 0.59 | 0.82 | 0.61 | 0.37 | 0.98 | 0.72 | 0.42 | 0.76 | 0.69 | n/a | |
| 26 (660) | 0.89 | 0.79 | 0.67 | 1.00 | 0.78 | 0.45 | 0.66 | 0.63 | 0.59 | 0.92 | 0.69 | 0.41 | 1.00 | 0.78 | 0.45 | 0.79 | 0.72 | n/a | |
| 28 (711) | 0.91 | 0.81 | 0.69 | | 0.84 | 0.49 | 0.67 | 0.64 | 0.60 | 1.00 | 0.77 | 0.46 | | 0.84 | 0.49 | 0.82 | 0.75 | 0.63 | |
| 30 (762) | 0.94 | 0.83 | 0.70 | | 0.90 | 0.52 | 0.68 | 0.65 | 0.61 | | 0.85 | 0.51 | | 0.90 | 0.52 | 0.85 | 0.77 | 0.65 | |
| 36 (914) | 1.00 | 0.90 | 0.74 | | 1.00 | 0.63 | 0.72 | 0.68 | 0.63 | | 1.00 | 0.67 | | 1.00 | 0.63 | 0.94 | 0.85 | 0.72 | |
| > 48 (1219) | | 1.00 | 0.82 | | | 0.84 | 0.79 | 0.74 | 0.67 | | | 1.00 | | | 0.84 | 1.00 | 0.98 | 0.83 | |

Table 19 – Load adjustment factors for #10 rebar in cracked concrete ^{1,2,3}

| Embedment h_{ef} in (mm) | #10 Cracked concrete | Spacing factor in tension | | | Edge distance factor in tension | | | Spacing factor in shear ⁴ | | | Edge distance in shear | | | | | | Concrete thickness factor in shear ⁵ | | |
|-------------------------------|-------------------------|---------------------------|-------------|-------------|---------------------------------|-------------|-------------|--------------------------------------|-------------|-------------|------------------------------|-------------|-------------|--------------------------|-------------|-------------|---|-------------|-------------|
| | | f_{AN} | | | f_{RN} | | | f_{AV} | | | ⊥ Toward edge f_{RV} | | | ∥ To edge f_{RV} | | | f_{HV} | | |
| | | 11-1/4 (286) | 15 (381) | 25 (635) | 11-1/4 (286) | 15 (381) | 25 (635) | 11-1/4 (286) | 15 (381) | 25 (635) | 11-1/4 (286) | 15 (381) | 25 (635) | 11-1/4 (286) | 15 (381) | 25 (635) | 11-1/4 (286) | 15 (381) | 25 (635) |
| 1-3/4 (44) | n/a | n/a | n/a | 0.40 | 0.39 | 0.37 | n/a | n/a | n/a | 0.02 | 0.01 | 0.01 | 0.03 | 0.02 | 0.01 | n/a | n/a | n/a | |
| 6-1/4 (159) | 0.59 | 0.57 | 0.54 | 0.56 | 0.50 | 0.44 | 0.54 | 0.53 | 0.52 | 0.11 | 0.07 | 0.04 | 0.22 | 0.15 | 0.09 | n/a | n/a | n/a | |
| 7 (178) | 0.60 | 0.58 | 0.55 | 0.58 | 0.52 | 0.45 | 0.54 | 0.53 | 0.52 | 0.13 | 0.09 | 0.05 | 0.26 | 0.18 | 0.11 | n/a | n/a | n/a | |
| 8 (203) | 0.62 | 0.59 | 0.55 | 0.62 | 0.55 | 0.46 | 0.55 | 0.54 | 0.53 | 0.16 | 0.11 | 0.06 | 0.32 | 0.22 | 0.13 | n/a | n/a | n/a | |
| 9 (229) | 0.63 | 0.60 | 0.56 | 0.66 | 0.57 | 0.48 | 0.55 | 0.54 | 0.53 | 0.19 | 0.13 | 0.08 | 0.38 | 0.26 | 0.15 | n/a | n/a | n/a | |
| 10 (254) | 0.65 | 0.61 | 0.57 | 0.70 | 0.60 | 0.49 | 0.56 | 0.55 | 0.53 | 0.22 | 0.15 | 0.09 | 0.44 | 0.30 | 0.18 | n/a | n/a | n/a | |
| 11 (279) | 0.66 | 0.62 | 0.57 | 0.74 | 0.63 | 0.51 | 0.57 | 0.55 | 0.54 | 0.26 | 0.17 | 0.10 | 0.51 | 0.35 | 0.21 | n/a | n/a | n/a | |
| 12 (305) | 0.68 | 0.63 | 0.58 | 0.78 | 0.66 | 0.53 | 0.57 | 0.56 | 0.54 | 0.29 | 0.20 | 0.12 | 0.58 | 0.40 | 0.24 | n/a | n/a | n/a | |
| 14 (356) | 0.71 | 0.66 | 0.59 | 0.87 | 0.72 | 0.56 | 0.59 | 0.57 | 0.55 | 0.37 | 0.25 | 0.15 | 0.73 | 0.50 | 0.30 | n/a | n/a | n/a | |
| 14-1/4 (362) | 0.71 | 0.66 | 0.60 | 0.88 | 0.73 | 0.56 | 0.59 | 0.57 | 0.55 | 0.38 | 0.26 | 0.15 | 0.75 | 0.51 | 0.31 | 0.59 | n/a | n/a | |
| 16 (406) | 0.74 | 0.68 | 0.61 | 0.96 | 0.78 | 0.59 | 0.60 | 0.58 | 0.55 | 0.45 | 0.31 | 0.18 | 0.90 | 0.61 | 0.37 | 0.63 | n/a | n/a | |
| 17 (432) | 0.75 | 0.69 | 0.61 | 1.00 | 0.81 | 0.61 | 0.60 | 0.58 | 0.56 | 0.49 | 0.33 | 0.20 | 0.98 | 0.67 | 0.40 | 0.64 | n/a | n/a | |
| 18 (457) | 0.77 | 0.70 | 0.62 | | 0.85 | 0.62 | 0.61 | 0.59 | 0.56 | 0.54 | 0.36 | 0.22 | 1.00 | 0.73 | 0.44 | 0.66 | 0.58 | n/a | |
| 20 (508) | 0.80 | 0.72 | 0.63 | | 0.91 | 0.66 | 0.62 | 0.59 | 0.57 | 0.63 | 0.43 | 0.26 | | 0.85 | 0.51 | 0.70 | 0.61 | n/a | |
| 22 (559) | 0.83 | 0.74 | 0.65 | | 0.98 | 0.69 | 0.63 | 0.60 | 0.57 | 0.72 | 0.49 | 0.30 | | 0.98 | 0.59 | 0.73 | 0.64 | n/a | |
| 24 (610) | 0.86 | 0.77 | 0.66 | | 1.00 | 0.73 | 0.65 | 0.61 | 0.58 | 0.82 | 0.56 | 0.34 | | 1.00 | 0.67 | 0.77 | 0.67 | n/a | |
| 26 (660) | 0.89 | 0.79 | 0.67 | | | 0.77 | 0.66 | 0.62 | 0.59 | 0.93 | 0.63 | 0.38 | | | 0.76 | 0.80 | 0.70 | n/a | |
| 28 (711) | 0.91 | 0.81 | 0.69 | | | 0.81 | 0.67 | 0.63 | 0.59 | 1.00 | 0.71 | 0.42 | | | 0.81 | 0.83 | 0.73 | 0.61 | |
| 30 (762) | 0.94 | 0.83 | 0.70 | | | 0.85 | 0.68 | 0.64 | 0.60 | | 0.78 | 0.47 | | | 0.85 | 0.86 | 0.75 | 0.64 | |
| 36 (914) | 1.00 | 0.90 | 0.74 | | | 0.97 | 0.72 | 0.67 | 0.62 | | 1.00 | 0.62 | | | 0.97 | 0.94 | 0.82 | 0.70 | |
| > 48 (1219) | | 1.00 | 0.82 | | | 1.00 | 0.79 | 0.73 | 0.66 | | | 0.95 | | | 1.00 | 1.00 | 0.95 | 0.80 | |

1 Linear interpolation not permitted
 2 Shaded area with reduced edge distance is permitted provided the rebar has no installation torque.
 3 When combining multiple load adjustment factors (e.g. for a four-anchor pattern in a corner with thin concrete member) the design can become very conservative. To optimize the design, use Hilti PROFIS Anchor Design software or perform anchor calculation using design equations from ACI 318 Chapter 17.
 4 Spacing factor reduction in shear applicable when $c_a < 3 \cdot h_{ef}$, f_{AV} is applicable when edge distance, $c_a < 3 \cdot h_{ef}$. If $c_a \geq 3 \cdot h_{ef}$, then $f_{AV} = f_{AN}$.
 5 Concrete thickness reduction factor in shear, f_{HV} is applicable when edge distance, $c_a < 3 \cdot h_{ef}$. If $c_a \geq 3 \cdot h_{ef}$, then $f_{HV} = 1.0$.

Hilti HIT-HY 100 adhesive with Hilti HAS threaded rod

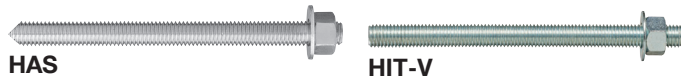

Hilti HAS / HIT-V threaded rod installation conditions

| | | | | | | | |
|----------------------------|--|--------------------|--|--------------------------|-----------------------------|--|---|
| Permissible Base Materials | | Uncracked concrete | | Dry Concrete | Permissible Drilling Method | | Hammer Drilling with Carbide Tipped Drill Bit |
| | | Cracked concrete | | Water Saturated Concrete | | | Hollow Drill Bit |

Hilti HAS/HIT-V threaded rod installation specifications

| Nominal Rod Diameter | Drill Bit Diameter | Embedment Depth Range | Maximum Installation Torque | Minimum Base Material Thickness |
|----------------------|----------------------|------------------------------|--------------------------------|---|
| d in (mm) | d ₀ in | h _{ef} in (mm) | T _{max} ft-lb (Nm) | h _{min} in (mm) |
| 3/8 (9.5) | 7/16 | 2-3/8 - 7-1/2 (60 - 191) | 15 (20) | h _{ef} + 1-1/4 (h _{ef} + 30) |
| 1/2 (12.7) | 9/16 | 2-3/4 - 10 (70 - 254) | 30 (41) | |
| 5/8 (15.9) | 3/4 | 3-1/8 - 12-1/2 (79 - 318) | 60 (81) | h _{ef} + 2d ₀ |
| 3/4 (19.1) | 7/8 | 3-1/2 - 15 (89 - 381) | 100 (136) | |
| 7/8 (22.2) | 1 | 3-1/2 - 17-1/2 (89 - 445) | 125 (169) | |
| 1 (25.4) | 1-1/8 | 4 - 20 (102 - 508) | 150 (203) | |
| 1-1/4 (31.8) | 1-3/8 | 5 - 25 (127 - 635) | 200 (271) | |

| d _f | HAS/HIT-V | 3/8 | 1/2 | 5/8 | 3/4 | 7/8 | 1 | 1-1/4 |
|------------------|-----------|------|------|--------|--------|--------|--------|--------|
| d _{f,1} | | 1/2 | 5/8 | 13/16* | 15/16* | 1-1/8* | 1-1/4* | 1-1/2* |
| d _{f,2} | | 7/16 | 9/16 | 11/16 | 13/16 | 15/16 | 1-1/8* | 1-3/8 |

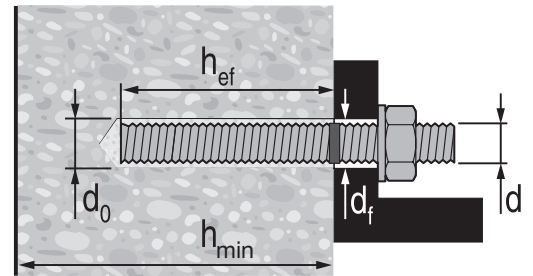

* Use two washers

Table 20 — Hilti HIT-HY 100 adhesive design strength with concrete / bond failure for threaded rod in uncracked concrete ^{1,2,3,4,5,6,7,8}

| Nominal anchor diameter in. | Effective embedment in. (mm) | Tension — ϕN_n | | | | Shear — ϕV_n | | | |
|-----------------------------|------------------------------|---|---|---|---|---|---|---|---|
| | | $f'_c = 2500$ psi (17.2 Mpa) lb (kN) | $f'_c = 3000$ psi (20.7 Mpa) lb (kN) | $f'_c = 4000$ psi (27.6 Mpa) lb (kN) | $f'_c = 6000$ psi (41.4 Mpa) lb (kN) | $f'_c = 2500$ psi (17.2 Mpa) lb (kN) | $f'_c = 3000$ psi (20.7 Mpa) lb (kN) | $f'_c = 4000$ psi (27.6 Mpa) lb (kN) | $f'_c = 6000$ psi (41.4 Mpa) lb (kN) |
| 3/8 | 2-3/8 (60) | 2,710 (12.1) | 2,760 (12.3) | 2,840 (12.6) | 2,960 (13.2) | 2,920 (13.0) | 2,970 (13.2) | 3,060 (13.6) | 3,185 (14.2) |
| | 3-3/8 (86) | 3,850 (17.1) | 3,920 (17.4) | 4,035 (17.9) | 4,205 (18.7) | 8,295 (36.9) | 8,445 (37.6) | 8,695 (38.7) | 9,055 (40.3) |
| | 4-1/2 (114) | 5,135 (22.8) | 5,230 (23.3) | 5,380 (23.9) | 5,605 (24.9) | 11,060 (49.2) | 11,260 (50.1) | 11,590 (51.6) | 12,070 (53.7) |
| | 7-1/2 (191) | 8,555 (38.1) | 8,715 (38.8) | 8,970 (39.9) | 9,340 (41.5) | 18,430 (82.0) | 18,770 (83.5) | 19,320 (85.9) | 20,120 (89.5) |
| 1/2 | 2-3/4 (70) | 3,555 (15.8) | 3,895 (17.3) | 4,385 (19.5) | 4,565 (20.3) | 7,660 (34.1) | 8,395 (37.3) | 9,445 (42.0) | 9,835 (43.7) |
| | 4-1/2 (114) | 6,845 (30.4) | 6,970 (31.0) | 7,175 (31.9) | 7,470 (33.2) | 14,745 (65.6) | 15,015 (66.8) | 15,455 (68.7) | 16,095 (71.6) |
| | 6 (152) | 9,130 (40.6) | 9,295 (41.3) | 9,565 (42.5) | 9,965 (44.3) | 19,660 (87.5) | 20,020 (89.1) | 20,605 (91.7) | 21,460 (95.5) |
| | 10 (254) | 15,215 (67.7) | 15,495 (68.9) | 15,945 (70.9) | 16,605 (73.9) | 32,765 (145.7) | 33,370 (148.4) | 34,345 (152.8) | 35,765 (159.1) |
| 5/8 | 3-1/8 (79) | 4,310 (19.2) | 4,720 (21.0) | 5,450 (24.2) | 6,485 (28.8) | 9,280 (41.3) | 10,165 (45.2) | 11,740 (52.2) | 13,970 (62.1) |
| | 5-5/8 (143) | 10,405 (46.3) | 10,895 (48.5) | 11,210 (49.9) | 11,675 (51.9) | 22,415 (99.7) | 23,465 (104.4) | 24,150 (107.4) | 25,145 (111.9) |
| | 7-1/2 (191) | 14,260 (63.4) | 14,525 (64.6) | 14,950 (66.5) | 15,565 (69.2) | 30,720 (136.6) | 31,285 (139.2) | 32,195 (143.2) | 33,530 (149.1) |
| | 12-1/2 (318) | 23,770 (105.7) | 24,210 (107.7) | 24,915 (110.8) | 25,945 (115.4) | 51,200 (227.7) | 52,140 (231.9) | 53,660 (238.7) | 55,880 (248.6) |
| 3/4 | 3-1/2 (89) | 5,105 (22.7) | 5,595 (24.9) | 6,460 (28.7) | 7,910 (35.2) | 11,000 (48.9) | 12,050 (53.6) | 13,915 (61.9) | 17,040 (75.8) |
| | 6-3/4 (171) | 13,680 (60.9) | 14,985 (66.7) | 16,145 (71.8) | 16,815 (74.8) | 29,460 (131.0) | 32,275 (143.6) | 34,775 (154.7) | 36,210 (161.1) |
| | 9 (229) | 20,540 (91.4) | 20,915 (93.0) | 21,525 (95.7) | 22,415 (99.7) | 44,235 (196.8) | 45,050 (200.4) | 46,365 (206.2) | 48,280 (214.8) |
| | 15 (381) | 34,230 (152.3) | 34,860 (155.1) | 35,875 (159.6) | 37,360 (166.2) | 73,725 (327.9) | 75,080 (334.0) | 77,275 (343.7) | 80,470 (357.9) |
| 7/8 | 3-1/2 (89) | 5,105 (22.7) | 5,595 (24.9) | 6,460 (28.7) | 7,910 (35.2) | 11,000 (48.9) | 12,050 (53.6) | 13,915 (61.9) | 17,040 (75.8) |
| | 7-7/8 (200) | 17,235 (76.7) | 18,885 (84.0) | 20,500 (91.2) | 21,350 (95.0) | 37,125 (165.1) | 40,670 (180.9) | 44,155 (196.4) | 45,980 (204.5) |
| | 10-1/2 (267) | 26,080 (116.0) | 26,560 (118.1) | 27,335 (121.6) | 28,465 (126.6) | 56,170 (249.9) | 57,200 (254.4) | 58,870 (261.9) | 61,305 (272.7) |
| | 17-1/2 (445) | 43,465 (193.3) | 44,265 (196.9) | 45,555 (202.6) | 47,440 (211.0) | 93,615 (416.4) | 95,335 (424.1) | 98,120 (436.5) | 102,180 (454.5) |
| 1 | 4 (102) | 6,240 (27.8) | 6,835 (30.4) | 7,895 (35.1) | 9,665 (43.0) | 13,440 (59.8) | 14,725 (65.5) | 17,000 (75.6) | 20,820 (92.6) |
| | 9 (229) | 21,060 (93.7) | 23,070 (102.6) | 24,465 (108.8) | 25,475 (113.3) | 45,360 (201.8) | 49,690 (221.0) | 52,690 (234.4) | 54,870 (244.1) |
| | 12 (305) | 31,120 (138.4) | 31,695 (141.0) | 32,620 (145.1) | 33,970 (151.1) | 67,030 (298.2) | 68,260 (303.6) | 70,255 (312.5) | 73,160 (325.4) |
| | 20 (508) | 51,870 (230.7) | 52,820 (235.0) | 54,365 (241.8) | 56,615 (251.8) | 111,715 (496.9) | 113,770 (506.1) | 117,090 (520.8) | 121,935 (542.4) |
| 1-1/4 | 5 (127) | 8,720 (38.8) | 9,555 (42.5) | 11,030 (49.1) | 12,140 (54.0) | 18,785 (83.6) | 20,575 (91.5) | 23,760 (105.7) | 29,100 (129.4) |
| | 11-1/4 (286) | 25,025 (111.3) | 25,490 (113.4) | 26,230 (116.7) | 27,315 (121.5) | 63,395 (282.0) | 64,880 (288.6) | 66,770 (297.0) | 69,535 (309.3) |
| | 15 (381) | 33,370 (148.4) | 33,985 (151.2) | 34,975 (155.6) | 36,425 (162.0) | 84,940 (377.8) | 86,505 (384.8) | 89,030 (396.0) | 92,710 (412.4) |
| | 25 (635) | 55,615 (247.4) | 56,640 (251.9) | 58,290 (259.3) | 60,705 (270.0) | 141,570 (629.7) | 144,175 (641.3) | 148,380 (660.0) | 154,520 (687.3) |

1 See Section 3.1.8 (2017 PTG) for explanation on development of load values.
 2 See Section 3.1.8.6 (2017 PTG) to convert design strength value to ASD value.
 3 Linear interpolation between embedment depths and concrete compressive strengths is not permitted.
 4 Load values are for a single anchor with no spacing, edge distance, or concrete thickness factors. Apply spacing, edge distance, and concrete thickness factors in tables 23-35 as necessary. Compare to the steel values in table 22. The lesser of the values is to be used for the design.
 5 Data is for temperature range A: Max. short term temperature = 130°F (55°C), max. long term temperature = 110°F (43°C).
 For temperature range B: Max. short term temperature = 176°F (80°C), max. long term temperature = 110°F (43°C) multiply above value by 0.92.
 For temperature range C: Max. short term temperature = 210°F (99°C), max. long term temperature = 162°F (72°C) multiply above value by 0.71.
 Short term elevated concrete temperatures are those that occur over brief intervals, e.g., as a result of diurnal cycling. Long term concrete temperatures are roughly constant over significant periods of time.
 6 Tabular values are for dry concrete conditions. For water saturated concrete multiply design strength (factored resistance) by 0.85.
 7 Tabular values are for short term loads only. For sustained loads including overhead use, see Section 3.1.8.8 (2017 PTG).
 8 Tabular values are for normal-weight concrete only. For lightweight concrete multiply design strength by λ_s as follows:
 For sand-lightweight, $\lambda_s = 0.51$. For all-lightweight, $\lambda_s = 0.45$.

Table 21 — Hilti HIT-HY 100 adhesive design strength with concrete / bond failure for threaded rod in cracked concrete 1,2,3,4,5,6,7,8,9

| Nominal anchor diameter in. | Effective embedment in. (mm) | Tension — ϕN_n | | | | Shear — ϕV_n | | | |
|-----------------------------|------------------------------|---|---|---|---|---|---|---|---|
| | | $f'_c = 2500$ psi (17.2 Mpa) lb (kN) | $f'_c = 3000$ psi (20.7 Mpa) lb (kN) | $f'_c = 4000$ psi (27.6 Mpa) lb (kN) | $f'_c = 6000$ psi (41.4 Mpa) lb (kN) | $f'_c = 2500$ psi (17.2 Mpa) lb (kN) | $f'_c = 3000$ psi (20.7 Mpa) lb (kN) | $f'_c = 4000$ psi (27.6 Mpa) lb (kN) | $f'_c = 6000$ psi (41.4 Mpa) lb (kN) |
| 3/8 | 2-3/8 (60) | 1,120 (5.0) | 1,140 (5.1) | 1,170 (5.2) | 1,220 (5.4) | 1,205 (5.4) | 1,225 (5.4) | 1,260 (5.6) | 1,315 (5.8) |
| | 3-3/8 (86) | 1,590 (7.1) | 1,620 (7.2) | 1,665 (7.4) | 1,735 (7.7) | 3,425 (15.2) | 3,485 (15.5) | 3,590 (16.0) | 3,735 (16.6) |
| | 4-1/2 (114) | 2,120 (9.4) | 2,160 (9.6) | 2,220 (9.9) | 2,315 (10.3) | 4,565 (20.3) | 4,650 (20.7) | 4,785 (21.3) | 4,980 (22.2) |
| | 7-1/2 (191) | 3,530 (15.7) | 3,595 (16.0) | 3,700 (16.5) | 3,855 (17.1) | 7,610 (33.9) | 7,750 (34.5) | 7,975 (35.5) | 8,305 (36.9) |
| 1/2 | 2-3/4 (70) | 1,880 (8.4) | 1,915 (8.5) | 1,970 (8.8) | 2,055 (9.1) | 4,050 (18.0) | 4,125 (18.3) | 4,245 (18.9) | 4,425 (19.7) |
| | 4-1/2 (114) | 3,080 (13.7) | 3,135 (13.9) | 3,225 (14.3) | 3,360 (14.9) | 6,630 (29.5) | 6,750 (30.0) | 6,950 (30.9) | 7,235 (32.2) |
| | 6 (152) | 4,105 (18.3) | 4,180 (18.6) | 4,300 (19.1) | 4,480 (19.9) | 8,840 (39.3) | 9,005 (40.1) | 9,265 (41.2) | 9,650 (42.9) |
| | 10 (254) | 6,840 (30.4) | 6,965 (31.0) | 7,170 (31.9) | 7,465 (33.2) | 14,735 (65.5) | 15,005 (66.7) | 15,445 (68.7) | 16,080 (71.5) |
| 5/8 | 3-1/8 (79) | 2,890 (12.9) | 2,945 (13.1) | 3,030 (13.5) | 3,155 (14.0) | 6,230 (27.7) | 6,345 (28.2) | 6,530 (29.0) | 6,800 (30.2) |
| | 5-5/8 (143) | 5,205 (23.2) | 5,300 (23.6) | 5,455 (24.3) | 5,680 (25.3) | 11,210 (49.9) | 11,415 (50.8) | 11,750 (52.3) | 12,235 (54.4) |
| | 7-1/2 (191) | 6,940 (30.9) | 7,065 (31.4) | 7,275 (32.4) | 7,575 (33.7) | 14,945 (66.5) | 15,220 (67.7) | 15,665 (69.7) | 16,315 (72.6) |
| | 12-1/2 (318) | 11,565 (51.4) | 11,780 (52.4) | 12,125 (53.9) | 12,625 (56.2) | 24,910 (110.8) | 25,370 (112.9) | 26,110 (116.1) | 27,190 (120.9) |
| 3/4 | 3-1/2 (89) | 3,620 (16.1) | 3,965 (17.6) | 4,355 (19.4) | 4,535 (20.2) | 7,790 (34.7) | 8,535 (38.0) | 9,380 (41.7) | 9,765 (43.4) |
| | 6-3/4 (171) | 8,010 (35.6) | 8,160 (36.3) | 8,395 (37.3) | 8,745 (38.9) | 17,255 (76.8) | 17,575 (78.2) | 18,085 (80.4) | 18,835 (83.8) |
| | 9 (229) | 10,680 (47.5) | 10,880 (48.4) | 11,195 (49.8) | 11,660 (51.9) | 23,010 (102.4) | 23,430 (104.2) | 24,115 (107.3) | 25,115 (111.7) |
| | 15 (381) | 17,805 (79.2) | 18,130 (80.6) | 18,660 (83.0) | 19,435 (86.5) | 38,345 (170.6) | 39,055 (173.7) | 40,190 (178.8) | 41,855 (187.2) |
| 7/8 | 3-1/2 (89) | 3,620 (16.1) | 3,965 (17.6) | 4,575 (20.4) | 5,325 (23.7) | 7,790 (34.7) | 8,535 (38.0) | 9,855 (43.8) | 11,470 (51.0) |
| | 7-7/8 (200) | 10,975 (48.8) | 11,175 (49.7) | 11,505 (51.2) | 11,980 (53.3) | 23,640 (105.2) | 24,075 (107.1) | 24,775 (110.2) | 25,800 (114.8) |
| | 10-1/2 (267) | 14,635 (65.1) | 14,905 (66.3) | 15,340 (68.2) | 15,975 (71.1) | 31,520 (140.2) | 32,100 (142.8) | 33,035 (146.9) | 34,405 (153.0) |
| | 17-1/2 (445) | 24,390 (108.5) | 24,840 (110.5) | 25,565 (113.7) | 26,620 (118.4) | 52,530 (233.7) | 53,500 (238.0) | 55,060 (244.9) | 57,340 (255.1) |
| 1 | 4 (102) | 4,420 (19.7) | 4,840 (21.5) | 5,590 (24.9) | 6,845 (30.4) | 9,520 (42.3) | 10,430 (46.4) | 12,040 (53.6) | 14,750 (65.6) |
| | 9 (229) | 14,520 (64.6) | 14,785 (65.8) | 15,220 (67.7) | 15,845 (70.5) | 31,270 (139.1) | 31,845 (141.7) | 32,775 (145.8) | 34,135 (151.8) |
| | 12 (305) | 19,360 (86.1) | 19,715 (87.7) | 20,290 (90.3) | 21,130 (94.0) | 41,695 (185.5) | 42,460 (188.9) | 43,700 (194.4) | 45,510 (202.4) |
| | (508) | 32,265 (143.5) | 32,860 (146.2) | 33,815 (150.4) | 35,215 (156.6) | 69,490 (309.1) | 70,770 (314.8) | 72,835 (324.0) | 75,850 (337.4) |

1 See Section 3.1.8 (2017 PTG) for explanation on development of load values.
2 See Section 3.1.8.6 (2017 PTG) to convert design strength value to ASD value.
3 Linear interpolation between embedment depths and concrete compressive strengths is not permitted.
4 Load values are for a single anchor with no spacing, edge distance, or concrete thickness factors. Apply spacing, edge distance, and concrete thickness factors in tables 23-35 as necessary. Compare to the steel values in table 22. The lesser of the values is to be used for the design.
5 Data is for temperature range A: Max. short term temperature = 130°F (55°C), max. long term temperature = 110°F (43°C).
For temperature range B: Max. short term temperature = 176°F (80°C), max. long term temperature = 110°F (43°C) multiply above value by 0.92.
For temperature range C: Max. short term temperature = 210°F (99°C), max. long term temperature = 162°F (72°C) multiply above value by 0.71.
Short term elevated concrete temperatures are those that occur over brief intervals, e.g., as a result of diurnal cycling. Long term concrete temperatures are roughly constant over significant periods of time.
6 Tabular values are for dry concrete conditions. For water saturated concrete multiply design strength (factored resistance) by 0.85.
7 Tabular values are for short term loads only. For sustained loads including overhead use, see Section 3.1.8.8 (2017 PTG).
8 Tabular values are for normal-weight concrete only. For lightweight concrete multiply design strength by λ_a as follows:
For sand-lightweight, $\lambda_a = 0.51$. For all-lightweight, $\lambda_a = 0.45$.
9 Tabular values are for static loads only. For seismic loads, multiply cracked concrete tabular values in tension and shear by $\alpha_{seis} = 0.75$

Table 22 – Steel design strength HAS and HIT-V anchor threaded rods for use with ACI 318-14 Ch. 17

| Nominal anchor diameter in. | HIT-V ASTM A307 Grade A ⁴ | | | HAS-E ISO 898 Class 5.8 ⁴ | | | HAS-E-B and HAS-E-B HDG ASTM A193 B7 and ASTM F 1554 Gr. 105 ⁵ | | |
|-----------------------------|--|--|---|--|--|---|---|--|---|
| | Tensile ¹ ϕN_{sa} lb (kN) | Shear ² ϕV_{sa} lb (kN) | Seismic Shear ³ $\phi V_{sa,eq}$ lb (kN) | Tensile ¹ ϕN_{sa} lb (kN) | Shear ² ϕV_{sa} lb (kN) | Seismic Shear ³ $\phi V_{sa,eq}$ lb (kN) | Tensile ¹ ϕN_{sa} lb (kN) | Shear ² ϕV_{sa} lb (kN) | Seismic Shear ³ $\phi V_{sa,eq}$ lb (kN) |
| 3/8 | 3,025 (13.5) | 1,675 (7.5) | 1,175 (5.2) | 3,655 (16.3) | 2,020 (9.0) | 1,415 (6.3) | 7,265 (32.3) | 3,780 (16.8) | 2,645 (11.8) |
| 1/2 | 5,535 (24.6) | 3,065 (13.6) | 2,145 (9.5) | 6,690 (29.5) | 3,705 (16.5) | 2,595 (11.5) | 13,300 (59.2) | 6,915 (30.8) | 4,840 (21.5) |
| 5/8 | 8,815 (39.2) | 4,880 (21.6) | 3,415 (15.2) | 10,650 (47.4) | 5,900 (26.2) | 4,130 (18.4) | 21,190 (94.3) | 11,020 (49.0) | 7,715 (34.3) |
| 3/4 | 13,045 (58.0) | 7,225 (32.1) | 5,060 (22.5) | 15,765 (70.1) | 8,730 (38.8) | 6,110 (27.2) | 31,360 (139.5) | 16,305 (72.5) | 11,415 (50.8) |
| 7/8 | - - | - - | - - | 21,755 (96.8) | 12,050 (53.6) | 8,435 (37.5) | 43,285 (192.5) | 22,505 (100.1) | 15,755 (70.1) |
| 1 | 23,620 (105.1) | 13,085 (58.2) | 9,160 (40.7) | 28,540 (127.0) | 15,805 (70.3) | 11,065 (49.2) | 56,785 (252.6) | 29,525 (131.3) | 20,670 (91.9) |
| 1-1/4 | - - | - - | - - | 45,670 (200.3) | 25,295 (112.5) | 17,705 (78.8) | 90,850 (404.1) | 47,240 (210.1) | 33,070 (147.1) |

- 1 Tensile = $\phi A_{se,N} f_{uta}$ as noted in ACI 318-14 17.4.1.2
- 2 Shear = $\phi 0.60 A_{se,V} f_{uta}$ as noted in ACI 318-14 17.5.1.2b.
- 3 Seismic Shear = $\alpha_{v,seis} \phi V_{sa}$: Reduction factor for seismic shear only. See ACI 318 for additional information on seismic applications.
- 4 HIT-V and HAS-E threaded rods are considered brittle steel elements. HIT-V does not comply with % elongation requirements of ASTM A307 Grade A steel. HAS-E does not comply with % elongation requirements of ISO 898-1.
- 5 HAS-E-B and HAS-E-B HDG rods are considered ductile steel elements.

Table 22 (Continued) – Steel design strength for Hilti HAS threaded rods for use with ACI 318 Chapter 17

| Nominal anchor diameter in. | HAS-V / HAS-V HDG ASTM F1554 Gr. 36 ^{4,6} | | | HAS-E / HAS-E HDG ASTM F1554 Gr. 55 ^{4,6} | | | HAS-B and HAS-B HDG ASTM A193 B7 and ASTM F 1554 Gr. 105 ^{4,6} | | | HAS-R Stainless Steel ASTM F593 (3/8-in to 1-in) ⁵ ASTM A193 (1-1/8-in to 1-1/4-in) ⁴ | | |
|-----------------------------|---|--|---|---|--|---|---|--|---|---|--|---|
| | Tensile ¹ ϕN_{sa} lb (kN) | Shear ² ϕV_{sa} lb (kN) | Seismic Shear ³ $\phi V_{sa,eq}$ lb (kN) | Tensile ¹ ϕN_{sa} lb (kN) | Shear ² ϕV_{sa} lb (kN) | Seismic Shear ³ $\phi V_{sa,eq}$ lb (kN) | Tensile ¹ ϕN_{sa} lb (kN) | Shear ² ϕV_{sa} lb (kN) | Seismic Shear ³ $\phi V_{sa,eq}$ lb (kN) | Tensile ¹ ϕN_{sa} lb (kN) | Shear ⁶ ϕV_{sa} lb (kN) | Seismic Shear ³ $\phi V_{sa,eq}$ lb (kN) |
| 3/8 | 3,370 (15.0) | 1,750 (7.8) | 1,050 (4.7) | 4,360 (19.4) | 2,270 (10.1) | 1,590 (7.1) | 7,270 (32.3) | 3,780 (16.8) | 2,645 (11.8) | 5,040 (22.4) | 2,790 (12.4) | 1,955 (8.7) |
| 1/2 | 6,175 (27.5) | 3,210 (14.3) | 1,925 (8.6) | 7,985 (35.5) | 4,150 (18.5) | 2,905 (12.9) | 13,305 (59.2) | 6,920 (30.8) | 4,845 (21.6) | 9,225 (41.0) | 5,110 (22.7) | 3,575 (15.9) |
| 5/8 | 9,835 (43.7) | 5,110 (22.7) | 3,065 (13.6) | 12,715 (56.6) | 6,610 (29.4) | 4,625 (20.6) | 21,190 (94.3) | 11,020 (49.0) | 7,715 (34.3) | 14,690 (65.3) | 8,135 (36.2) | 5,695 (25.3) |
| 3/4 | 14,550 (64.7) | 7,565 (33.7) | 4,540 (20.2) | 18,820 (83.7) | 9,785 (43.5) | 6,850 (30.5) | 31,360 (139.5) | 16,310 (72.6) | 11,415 (50.8) | 18,485 (82.2) | 10,235 (45.5) | 7,165 (31.9) |
| 7/8 | 20,085 (89.3) | 10,445 (46.5) | 6,265 (27.9) | 25,975 (115.5) | 13,505 (60.1) | 9,455 (42.1) | 43,285 (192.5) | 22,510 (100.1) | 15,755 (70.1) | 25,510 (113.5) | 14,125 (62.8) | 9,890 (44.0) |
| 1 | 26,350 (117.2) | 13,700 (60.9) | 8,220 (36.6) | 34,075 (151.6) | 17,720 (78.8) | 12,405 (55.2) | 56,785 (252.6) | 29,530 (131.4) | 20,670 (91.9) | 33,465 (148.9) | 18,535 (82.4) | 12,975 (57.7) |
| 1-1/4 | 42,160 (187.5) | 21,920 (97.5) | 13,150 (58.5) | 54,515 (242.5) | 28,345 (126.1) | 19,840 (88.3) | 90,855 (404.1) | 47,245 (210.2) | 33,070 (147.1) | 41,430 (184.3) | 21,545 (95.8) | 12,925 (57.5) |

- 1 Tensile = $\phi A_{se,N} f_{uta}$ as noted in ACI 318-14 17.4.1.2
- 2 Shear = $\phi 0.60 A_{se,V} f_{uta}$ as noted in ACI 318-14 17.5.1.2b.
- 3 Seismic Shear = $\alpha_{v,seis} \phi V_{sa}$: Reduction factor for seismic shear only. See ACI 318 for additional information on seismic applications.
- 4 HAS-V, HAS-E, HAS-B, and HAS-R (Class 1; 1-1/8-in to 1-1/4-in) threaded rods are considered ductile steel elements (included HDG rods).
- 5 HAS-E-B and HAS-E-B HDG rods are considered ductile steel elements.
- 6 HAS-R (CW1 and CW2; 3/8-in to 1-in) threaded rods are considered brittle steel elements (including HDG rods).
- 7 3/8-inch dia. threaded rods are not included in the ASTM F1554 standard. Hilti 3/8-inch dia. HAS-V, HAS-E, and HAS-E-B (incl. HDG) threaded rods meet the chemical composition and mechanical property requirements of ASTM F1554.

Table 35 – Load adjustment factors for 1-1/4-in. diameter threaded rods in uncracked concrete ^{1,2,3}





| 1-1/4-in. Uncracked concrete | Spacing factor in tension f_{AN} | | | | Edge distance factor in tension f_{RN} | | | | Spacing factor in shear ⁴ f_{AV} | | | | Edge distance in shear | | | | | | | | Concrete thickness factor in shear ⁵ f_{HV} | | | | |
|------------------------------|---------------------------------------|--------------|----------|----------|---|--------------|----------|----------|--|--------------|----------|----------|------------------------------|--------------|----------|----------|--------------------------|--------------|----------|----------|---|--------------|----------|----------|------|
| | | | | | | | | | | | | | ⊥ Toward edge f_{RV} | | | | ∥ To edge f_{RV} | | | | | | | | |
| Embedment h_{ef} in (mm) | 5 (127) | 11-1/4 (286) | 15 (381) | 25 (635) | 5 (127) | 11-1/4 (286) | 15 (381) | 25 (635) | 5 (127) | 11-1/4 (286) | 15 (381) | 25 (635) | 5 (127) | 11-1/4 (286) | 15 (381) | 25 (635) | 5 (127) | 11-1/4 (286) | 15 (381) | 25 (635) | 5 (127) | 11-1/4 (286) | 15 (381) | 25 (635) | |
| 1-3/4 (44) | n/a | n/a | n/a | n/a | 0.37 | 0.22 | 0.16 | 0.09 | n/a | n/a | n/a | n/a | 0.05 | 0.02 | 0.01 | 0.01 | 0.11 | 0.03 | 0.02 | 0.01 | n/a | n/a | n/a | n/a | |
| 6-1/4 (159) | 0.62 | 0.59 | 0.57 | 0.54 | 0.63 | 0.32 | 0.24 | 0.14 | 0.59 | 0.54 | 0.53 | 0.52 | 0.37 | 0.11 | 0.08 | 0.05 | 0.63 | 0.22 | 0.16 | 0.10 | n/a | n/a | n/a | n/a | |
| 7 (178) | 0.64 | 0.60 | 0.58 | 0.55 | 0.67 | 0.34 | 0.25 | 0.15 | 0.60 | 0.54 | 0.54 | 0.53 | 0.44 | 0.13 | 0.10 | 0.06 | 0.67 | 0.26 | 0.19 | 0.12 | n/a | n/a | n/a | n/a | |
| 8 (203) | 0.66 | 0.62 | 0.59 | 0.55 | 0.73 | 0.37 | 0.27 | 0.16 | 0.61 | 0.55 | 0.54 | 0.53 | 0.53 | 0.16 | 0.12 | 0.07 | 0.73 | 0.32 | 0.24 | 0.14 | 0.66 | n/a | n/a | n/a | |
| 9 (229) | 0.68 | 0.63 | 0.60 | 0.56 | 0.78 | 0.40 | 0.29 | 0.17 | 0.62 | 0.56 | 0.55 | 0.53 | 0.63 | 0.19 | 0.14 | 0.08 | 0.78 | 0.38 | 0.28 | 0.17 | 0.70 | n/a | n/a | n/a | |
| 10 (254) | 0.70 | 0.65 | 0.61 | 0.57 | 0.84 | 0.43 | 0.32 | 0.19 | 0.64 | 0.56 | 0.55 | 0.54 | 0.74 | 0.22 | 0.16 | 0.10 | 0.84 | 0.43 | 0.32 | 0.19 | 0.74 | n/a | n/a | n/a | |
| 11 (279) | 0.72 | 0.66 | 0.62 | 0.57 | 0.90 | 0.46 | 0.34 | 0.20 | 0.65 | 0.57 | 0.56 | 0.54 | 0.86 | 0.25 | 0.19 | 0.11 | 0.90 | 0.46 | 0.34 | 0.20 | 0.78 | n/a | n/a | n/a | |
| 12 (305) | 0.74 | 0.68 | 0.63 | 0.58 | 0.96 | 0.49 | 0.36 | 0.21 | 0.66 | 0.57 | 0.56 | 0.54 | 0.98 | 0.29 | 0.22 | 0.13 | 0.96 | 0.49 | 0.36 | 0.21 | 0.81 | n/a | n/a | n/a | |
| 13 (330) | 0.76 | 0.69 | 0.64 | 0.59 | 1.00 | 0.53 | 0.39 | 0.23 | 0.68 | 0.58 | 0.57 | 0.55 | 1.00 | 0.33 | 0.24 | 0.15 | 1.00 | 0.53 | 0.39 | 0.23 | 0.84 | n/a | n/a | n/a | |
| 14 (356) | 0.78 | 0.71 | 0.66 | 0.59 | | 0.57 | 0.42 | 0.24 | 0.69 | 0.59 | 0.57 | 0.55 | | 0.36 | 0.27 | 0.16 | | 0.57 | 0.42 | 0.24 | 0.88 | 0.58 | n/a | n/a | |
| 14-1/4 (362) | 0.78 | 0.71 | 0.66 | 0.60 | | 0.58 | 0.42 | 0.25 | 0.70 | 0.59 | 0.57 | 0.55 | | 0.37 | 0.28 | 0.17 | | 0.58 | 0.42 | 0.25 | 0.88 | 0.59 | n/a | n/a | |
| 15 (381) | 0.80 | 0.72 | 0.67 | 0.60 | | 0.61 | 0.45 | 0.26 | 0.71 | 0.59 | 0.58 | 0.55 | | 0.40 | 0.30 | 0.18 | | 0.61 | 0.45 | 0.26 | 0.91 | 0.60 | n/a | n/a | |
| 16 (406) | 0.82 | 0.74 | 0.68 | 0.61 | | 0.65 | 0.48 | 0.28 | 0.72 | 0.60 | 0.58 | 0.56 | | 0.45 | 0.33 | 0.20 | | 0.65 | 0.48 | 0.28 | 0.94 | 0.62 | n/a | n/a | |
| 17 (432) | 0.84 | 0.75 | 0.69 | 0.61 | | 0.69 | 0.51 | 0.30 | 0.73 | 0.60 | 0.59 | 0.56 | | 0.49 | 0.36 | 0.22 | | 0.69 | 0.51 | 0.30 | 0.96 | 0.64 | n/a | n/a | |
| 18 (457) | 0.86 | 0.77 | 0.70 | 0.62 | | 0.73 | 0.54 | 0.31 | 0.75 | 0.61 | 0.59 | 0.56 | | 0.53 | 0.40 | 0.24 | | 0.73 | 0.54 | 0.31 | 0.99 | 0.66 | 0.60 | n/a | |
| 20 (508) | 0.90 | 0.80 | 0.72 | 0.63 | | 0.81 | 0.59 | 0.35 | 0.77 | 0.62 | 0.60 | 0.57 | | 0.62 | 0.46 | 0.28 | | 0.81 | 0.59 | 0.35 | 1.00 | 0.70 | 0.63 | n/a | |
| 22 (559) | 0.94 | 0.83 | 0.74 | 0.65 | | 0.89 | 0.65 | 0.38 | 0.80 | 0.63 | 0.61 | 0.58 | | 0.72 | 0.54 | 0.32 | | 0.89 | 0.65 | 0.38 | | 0.73 | 0.66 | n/a | |
| 24 (610) | 0.98 | 0.86 | 0.77 | 0.66 | | 0.97 | 0.71 | 0.42 | 0.83 | 0.65 | 0.62 | 0.59 | | 0.82 | 0.61 | 0.37 | | 0.97 | 0.71 | 0.42 | | 0.76 | 0.69 | n/a | |
| 26 (660) | 1.00 | 0.89 | 0.79 | 0.67 | | 1.00 | 0.77 | 0.45 | 0.86 | 0.66 | 0.63 | 0.59 | | 0.92 | 0.69 | 0.41 | | 1.00 | 0.77 | 0.45 | | 0.80 | 0.72 | n/a | |
| 28 (711) | | 0.92 | 0.81 | 0.69 | | | 0.83 | 0.49 | 0.88 | 0.67 | 0.64 | 0.60 | | 1.00 | 0.77 | 0.46 | | | 0.83 | 0.49 | | | 0.83 | 0.75 | 0.63 |
| 30 (762) | | 0.94 | 0.83 | 0.70 | | | 0.89 | 0.52 | 0.91 | 0.68 | 0.65 | 0.61 | | | 0.85 | 0.51 | | | 0.89 | 0.52 | | | 0.85 | 0.77 | 0.65 |
| 36 (914) | | 1.00 | 0.90 | 0.74 | | | 1.00 | 0.63 | 0.99 | 0.72 | 0.68 | 0.63 | | | 1.00 | 0.67 | | | 1.00 | 0.63 | | | 0.94 | 0.85 | 0.72 |
| > 48 (1219) | | | 1.00 | 0.82 | | | | 0.84 | 1.00 | 0.79 | 0.74 | 0.67 | | | | 1.00 | | | | 0.84 | | | 1.00 | 0.98 | 0.83 |

1 Linear interpolation not permitted
2 Shaded area with reduced edge distance is permitted provided the installation torque is reduced to $0.30 T_{max}$ for $5d \leq s \leq 16$ -in. and to $0.5 T_{max}$ for $s > 16$ -in.
3 When combining multiple load adjustment factors (e.g. for a four-anchor pattern in a corner with thin concrete member) the design can become very conservative. To optimize the design, use Hilti PROFIS Anchor Design software or perform anchor calculation using design equations from ACI 318 Chapter 17.
4 Spacing factor reduction in shear applicable when $c_a < 3 \cdot h_{ef}$, f_{AV} is applicable when edge distance, $c_a < 3 \cdot h_{ef}$. If $c_a \geq 3 \cdot h_{ef}$, then $f_{AV} = f_{AN}$.
5 Concrete thickness reduction factor in shear, f_{HV} is applicable when edge distance, $c_a < 3 \cdot h_{ef}$. If $c_a \geq 3 \cdot h_{ef}$, then $f_{HV} = 1.0$.

Hilti HIT-HY 100 adhesive with Hilti HIS-N and HIS-RN internally threaded insert

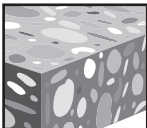
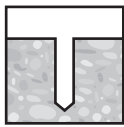

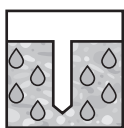
Hilti HIS-N and HIS-RN internally threaded insert installation conditions

| | | | | |
|----------------------------|---|---|-----------------------------|--|
| Permissible Base Materials |  <p>Uncracked concrete</p> |  <p>Dry Concrete</p> | Permissible Drilling Method |  <p>Hammer Drilling with Carbide Tipped Drill Bit</p> |
| | |  <p>Water Saturated Concrete</p> | |  <p>Hollow Drill Bit</p> |

Hilti HIS-N and HIS-RN installation specifications

| Internal Nominal Rod Diameter | Insert External Diameter | Drill Bit Diameter | Embedment Depth | Bolt Embedment | Maximum Installation Torque | Minimum Base Material Thickness |
|-------------------------------|--------------------------|--------------------|---------------------|----------------|-----------------------------|---------------------------------|
| d in (mm) | D in (mm) | d_0 in | h_{ef} in (mm) | h_s in | T_{max} ft-lb (Nm) | h_{min} in (mm) |
| 3/8 (9.5) | 0.65 (16.5) | 11/16 | 4-3/8 (110) | 3/8 - 15/16 | 15 (20) | 5.9 (150) |
| 1/2 (12.7) | 0.81 (20.5) | 7/8 | 5 (125) | 1/2 - 1-3/16 | 30 (41) | 6.7 (170) |
| 5/8 (15.9) | 1.00 (25.4) | 1-1/8 | 6-3/4 (170) | 5/8 - 1-1/2 | 60 (81) | 9.1 (230) |
| 3/4 (19.1) | 1.09 (27.6) | 1-1/4 | 8-1/8 (205) | 3/4 - 1-7/8 | 100 (136) | 10.6 (270) |

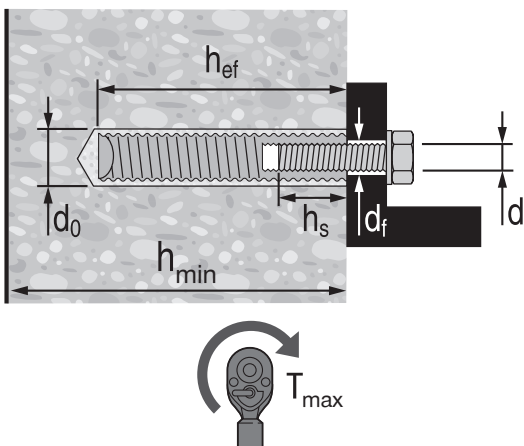

Table 36 — Hilti HIT-HY 100 adhesive design strength with concrete / bond failure for Hilti HIS-N and HIS-RN internally threaded inserts in uncracked concrete ^{1,2,3,4,5,6,7,8}

| Thread size | Effective Embedment Depth in. (mm) | Tension — ΦN_n | | | | Shear — ΦV_n | | | |
|-------------|------------------------------------|--------------------------------------|--------------------------------------|--------------------------------------|--------------------------------------|--------------------------------------|--------------------------------------|--------------------------------------|--------------------------------------|
| | | $f'_c = 2500$ psi (17.2 MPa) lb (kN) | $f'_c = 3000$ psi (20.7 MPa) lb (kN) | $f'_c = 4000$ psi (27.6 MPa) lb (kN) | $f'_c = 6000$ psi (41.4 MPa) lb (kN) | $f'_c = 2500$ psi (17.2 MPa) lb (kN) | $f'_c = 3000$ psi (20.7 MPa) lb (kN) | $f'_c = 4000$ psi (27.6 MPa) lb (kN) | $f'_c = 6000$ psi (41.4 MPa) lb (kN) |
| 3/8-16 UNC | 4-3/8 (111) | 7,140 (31.8) | 7,820 (34.8) | 7,985 (35.5) | 8,465 (37.7) | 15,375 (68.4) | 16,840 (74.9) | 17,200 (76.5) | 18,230 (81.1) |
| 1/2-13 UNC | 5 (127) | 8,720 (38.8) | 9,555 (42.5) | 10,505 (46.7) | 11,135 (49.5) | 18,785 (83.6) | 20,575 (91.5) | 22,620 (100.6) | 23,980 (106.7) |
| 5/8-11 UNC | 6-3/4 (171) | 13,680 (60.9) | 14,985 (66.7) | 15,160 (67.4) | 16,070 (71.5) | 29,460 (131.0) | 32,275 (143.6) | 32,655 (145.3) | 34,615 (154.0) |
| 3/4-10 UNC | 8-1/8 (206) | 15,760 (70.1) | 15,760 (70.1) | 15,760 (70.1) | 16,705 (74.3) | 38,910 (173.1) | 40,120 (178.5) | 40,120 (178.5) | 42,530 (189.2) |

- Table values determined from calculations according to ACI 318-11 Appendix D. See Section 2.4 for explanation on development of load values.
- See Section 3.1.8.6 (2017 PTG) to convert design strength value to ASD value.
- Linear interpolation between embedment depths and concrete compressive strengths is not permitted.
- Apply spacing, edge distance, and concrete thickness factors in table 38 as necessary. Compare to the steel values in table 37. The lesser of the values is to be used for the design.
- Data is for temperature range A: Max. short term temperature = 130°F (55°C), max. long term temperature = 110°F (43°C). For temperature range B: Max. short term temperature = 176°F (80°C), max. long term temperature = 110°F (43°C) multiply above value by 0.92. For temperature range C: Max. short term temperature = 210°F (99°C), max. long term temperature = 162°F (72°C) multiply above value by 0.71. Short term elevated concrete temperatures are those that occur over brief intervals, e.g., as a result of diurnal cycling. Long term concrete temperatures are roughly constant over significant periods of time.
- Tabular values are for dry concrete conditions. For water saturated concrete multiply design strength by 0.85.
- Tabular values are for short term loads only. For sustained loads including overhead use, see Section 3.1.8.8 (2017 PTG).
- Tabular values are for normal weight concrete only. For lightweight concrete multiply design strength by λ_n as follows: For sand-lightweight, $\lambda_n = 0.51$. For all-lightweight, $\lambda_n = 0.45$.

Table 37 — Steel design strength for steel bolt / cap screw for Hilti HIS-N and HIS-RN internally threaded inserts ^{1,2,3}

| Thread size | ASTM A 193 B7 | | ASTM A 193 Grade B8M Stainless Steel | |
|-------------|--|--|--|--|
| | Tensile ⁴ ΦN_{sa} lb (kN) | Shear ⁵ ΦV_{sa} lb (kN) | Tensile ⁴ ΦN_{sa} lb (kN) | Shear ⁵ ΦV_{sa} lb (kN) |
| 3/8-16 UNC | 6,300 (28.0) | 3,490 (15.5) | 5,540 (24.6) | 3,070 (13.7) |
| 1/2-13 UNC | 10,525 (46.8) | 6,385 (28.4) | 10,145 (45.1) | 5,620 (25.0) |
| 5/8-11 UNC | 17,500 (77.8) | 10,170 (45.2) | 16,160 (71.9) | 8,950 (39.8) |
| 3/4-10 UNC | 17,785 (79.1) | 15,055 (67.0) | 23,915 (106.4) | 13,245 (58.9) |

- See Section 2.4.4 (2017 PTG) to convert design strength value to ASD value.
- Hilti HIS-N and HIS-RN inserts with steel bolts are considered brittle steel elements.
- Table values are the lesser of steel failure in the HIS-N insert or inserted steel bolt.
- Tensile = $\Phi A_{se,N} f_{uta}$ as noted in ACI 318 Appendix D
- Shear = $\Phi 0.60 A_{se,V} f_{uta}$ as noted in ACI 318 Appendix D. For 3/8-in diameter insert shear = $\Phi 0.50 A_{se,V} f_{uta}$

Table 38 — Load adjustment factors for Hilti HIS-N and HIS-RN internally threaded inserts in uncracked concrete ^{1,2,3}

| HIS-N and HIS-RN All Diameters Uncracked Concrete | Spacing Factor in Tension f_{AN} | | | | Edge Distance Factor in Tension f_{RN} | | | | Spacing Factor in Shear ⁴ f_{AV} | | | | Edge Distance in Shear | | | | | | | | Concrete Thickness Factor in Shear ⁵ f_{HV} | | | | |
|--|--|---------------|----------------|----------------|--|---------------|----------------|----------------|---|---------------|----------------|----------------|------------------------------|---------------|----------------|----------------|--------------------------|---------------|----------------|----------------|--|---------------|----------------|----------------|------|
| | | | | | | | | | | | | | ⊥ Toward Edge f_{RV} | | | | ∥ To Edge f_{RV} | | | | | | | | |
| Internal Diameter in (mm) | 3/8 (9.5) | 1/2 (12.7) | 5/8 (15.9) | 3/4 (19.1) | 3/8 (9.5) | 1/2 (12.7) | 5/8 (15.9) | 3/4 (19.1) | 3/8 (9.5) | 1/2 (12.7) | 5/8 (15.9) | 3/4 (19.1) | 3/8 (9.5) | 1/2 (12.7) | 5/8 (15.9) | 3/4 (19.1) | 3/8 (9.5) | 1/2 (12.7) | 5/8 (15.9) | 3/4 (19.1) | 3/8 (9.5) | 1/2 (12.7) | 5/8 (15.9) | 3/4 (19.1) | |
| Embedment h_{ef} in (mm) | 4-3/8 (111) | 5 (127) | 6-3/4 (171) | 8-1/8 (206) | 4-3/8 (111) | 5 (127) | 6-3/4 (171) | 8-1/8 (206) | 4-3/8 (111) | 5 (127) | 6-3/4 (171) | 8-1/8 (206) | 4-3/8 (111) | 5 (127) | 6-3/4 (171) | 8-1/8 (206) | 4-3/8 (111) | 5 (127) | 6-3/4 (171) | 8-1/8 (206) | 4-3/8 (111) | 5 (127) | 6-3/4 (171) | 8-1/8 (206) | |
| Spacing (s) / Edge Distance (c_e) / Concrete Thickness (h_c) — in (mm) | 3-1/4 (83) | 0.61 | n/a | n/a | n/a | 0.40 | n/a | n/a | n/a | 0.55 | n/a | n/a | n/a | 0.15 | n/a | n/a | n/a | 0.31 | n/a | n/a | n/a | n/a | n/a | n/a | n/a |
| | 4 (102) | 0.63 | 0.61 | n/a | n/a | 0.45 | 0.43 | n/a | n/a | 0.56 | 0.55 | n/a | n/a | 0.21 | 0.19 | n/a | n/a | 0.42 | 0.38 | n/a | n/a | n/a | n/a | n/a | n/a |
| | 5 (127) | 0.67 | 0.64 | 0.62 | n/a | 0.52 | 0.49 | 0.44 | n/a | 0.57 | 0.57 | 0.55 | n/a | 0.29 | 0.26 | 0.17 | n/a | 0.52 | 0.49 | 0.33 | n/a | n/a | n/a | n/a | n/a |
| | 5-1/2 (140) | 0.68 | 0.65 | 0.63 | 0.61 | 0.56 | 0.52 | 0.46 | 0.40 | 0.58 | 0.58 | 0.56 | 0.55 | 0.34 | 0.30 | 0.19 | 0.15 | 0.56 | 0.52 | 0.39 | 0.29 | n/a | n/a | n/a | n/a |
| | 6 (152) | 0.70 | 0.67 | 0.65 | 0.62 | 0.59 | 0.55 | 0.49 | 0.42 | 0.59 | 0.58 | 0.56 | 0.55 | 0.39 | 0.35 | 0.22 | 0.17 | 0.59 | 0.55 | 0.44 | 0.33 | 0.60 | n/a | n/a | n/a |
| | 7 (178) | 0.73 | 0.70 | 0.67 | 0.64 | 0.68 | 0.62 | 0.53 | 0.46 | 0.60 | 0.60 | 0.57 | 0.56 | 0.49 | 0.43 | 0.28 | 0.21 | 0.68 | 0.62 | 0.53 | 0.42 | 0.64 | 0.62 | n/a | n/a |
| | 8 (203) | 0.77 | 0.72 | 0.69 | 0.66 | 0.77 | 0.70 | 0.58 | 0.50 | 0.62 | 0.61 | 0.58 | 0.57 | 0.60 | 0.53 | 0.34 | 0.26 | 0.77 | 0.70 | 0.58 | 0.51 | 0.69 | 0.66 | n/a | n/a |
| | 9 (229) | 0.80 | 0.75 | 0.72 | 0.68 | 0.87 | 0.78 | 0.63 | 0.54 | 0.63 | 0.62 | 0.59 | 0.58 | 0.71 | 0.63 | 0.40 | 0.31 | 0.87 | 0.78 | 0.63 | 0.56 | 0.73 | 0.70 | n/a | n/a |
| | 10 (254) | 0.83 | 0.78 | 0.74 | 0.71 | 0.97 | 0.87 | 0.69 | 0.59 | 0.65 | 0.64 | 0.60 | 0.58 | 0.83 | 0.74 | 0.47 | 0.36 | 0.97 | 0.87 | 0.69 | 0.61 | 0.77 | 0.74 | 0.64 | n/a |
| | 11 (279) | 0.87 | 0.81 | 0.77 | 0.73 | 1.00 | 0.96 | 0.75 | 0.63 | 0.66 | 0.65 | 0.61 | 0.59 | 0.96 | 0.86 | 0.55 | 0.41 | 1.00 | 0.96 | 0.75 | 0.65 | 0.81 | 0.78 | 0.67 | 0.61 |
| | 12 (305) | 0.90 | 0.83 | 0.79 | 0.75 | | 1.00 | 0.82 | 0.69 | 0.68 | 0.66 | 0.62 | 0.60 | 1.00 | 0.98 | 0.62 | 0.47 | | 1.00 | 0.82 | 0.69 | 0.84 | 0.81 | 0.70 | 0.64 |
| | 14 (356) | 0.97 | 0.89 | 0.84 | 0.79 | | | 0.96 | 0.81 | 0.71 | 0.69 | 0.64 | 0.62 | | 1.00 | 0.78 | 0.59 | | | 0.96 | 0.81 | 0.91 | 0.87 | 0.75 | 0.69 |
| | 16 (406) | 1.00 | 0.95 | 0.89 | 0.83 | | | 1.00 | 0.92 | 0.74 | 0.72 | 0.66 | 0.63 | | | 0.96 | 0.73 | | | 1.00 | 0.92 | 0.97 | 0.94 | 0.80 | 0.73 |
| | 18 (457) | | 1.00 | 0.94 | 0.87 | | | | 1.00 | 0.77 | 0.75 | 0.68 | 0.65 | | | 1.00 | 0.87 | | | | 1.00 | 1.00 | 0.99 | 0.85 | 0.78 |
| | 24 (610) | | | 1.00 | 0.99 | | | | | 0.85 | 0.83 | 0.74 | 0.70 | | | | 1.00 | | | | | | 1.00 | 0.99 | 0.90 |
| | 30 (762) | | | | 1.00 | | | | | 0.94 | 0.91 | 0.80 | 0.75 | | | | | | | | | | | 1.00 | 1.00 |
| | 36 (914) | | | | | | | | | 1.00 | 0.99 | 0.86 | 0.80 | | | | | | | | | | | | |
| >48 (1219) | | | | | | | | | | 1.00 | 0.99 | 0.90 | | | | | | | | | | | | | |

1 Linear interpolation not permitted
 2 When combining multiple load adjustment factors (e.g. for a four-anchor pattern in a corner with thin concrete member) the design can become very conservative. To optimize the design, perform anchor calculation using design equations from ACI 318 Appendix D or CSA A23.3 Annex D.
 3 Spacing factor reduction in shear, f_{AV} , assumes an influence of a nearby edge. If no edge exists, then $f_{AV} = f_{AN}$.
 4 Spacing factor reduction in shear applicable when $c < 3 \cdot h_{ef}$. f_{AV} is applicable when edge distance, $c < 3 \cdot h_{ef}$. If $c \geq 3 \cdot h_{ef}$, then $f_{AV} = f_{AN}$.
 5 Concrete thickness reduction factor in shear, f_{HV} , is applicable when edge distance, $c < 3 \cdot h_{ef}$. If $c \geq 3 \cdot h_{ef}$, then $f_{HV} = 1.0$.

DESIGN DATA IN CONCRETE PER CSA A23.3



CSA A23.3-14 Annex D design

Limit State Design of anchors is described in the provisions of CSA A23.3-14 Annex D for post-installed anchors tested and assessed in accordance with ACI 355.2 for mechanical anchors and ACI 355.4 for adhesive anchors. This section contains the Limit State Design tables with unfactored characteristic loads that are based on testing in accordance with ACI 355.4. These tables are followed by factored resistance tables. The factored resistance tables have characteristic design loads that are prefactored by the applicable reduction factors for a single anchor with no anchor-to-anchor spacing or edge distance adjustments for the convenience of the user of this document. All the figures in the previous ACI 318-14 Chapter 17 design section are applicable to Limit State Design and the tables will reference these figures.

For a detailed explanation of the tables developed in accordance with CSA A23.3-14 Annex D, refer to Section 3.1.8 of the Hilti North American Product Technical Guide, Volume 2: Anchor Fastening Technical Guide, Edition 17. Technical assistance is available by contacting Hilti Canada at (800) 363-4458 or at www.hilti.ca.

Table 39 – Hilti HIT-HY 100 adhesive design information with CA rebar in hammer drilled holes in accordance with CSA A23.3-14 Annex D¹



| Design parameter | Symbol | Units | Rebar size | | | | | Ref A23.3-14 | |
|--|---|-------------------|------------------------------|-----------------|----------------|----------------|----------------|-----------------|-----------|
| | | | 10M | 15M | 20M | 25M | 30M | | |
| Anchor O.D. | d_a | mm | 11.3 | 16.0 | 19.5 | 25.2 | 29.9 | | |
| Effective minimum embedment ² | $h_{ef,min}$ | mm | 70 | 80 | 90 | 101 | 120 | | |
| Effective maximum embedment ² | $h_{ef,max}$ | mm | 226 | 320 | 390 | 504 | 598 | | |
| Min. concrete thickness ² | h_{min} | mm | $h_{ef} + 30$ | $h_{ef} + 2d_a$ | | | | | |
| Critical edge distance | c_{ac} | - | See ESR-3187, section 4.1.10 | | | | | | |
| Minimum edge distance | c_{min} ³ | mm | 57 | 80 | 98 | 126 | 150 | | |
| Minimum anchor spacing | s_{min} | mm | 57 | 80 | 98 | 126 | 150 | | |
| Coeff. for factored conc. breakout resistance, uncracked concrete | $k_{c,unscr}$ ⁴ | - | 10 | | | | | D.6.2.2 | |
| Coeff. for factored conc. breakout resistance, cracked concrete | $k_{c,cr}$ ⁴ | - | 7 | | | | | D.6.2.2 | |
| Concrete material resistance factor | f_c | - | 0.65 | | | | | 8.4.2 | |
| Resistance modification factor for tension and shear, concrete failure modes, Condition B ⁵ | R_{conc} | - | 1.00 | | | | | D.5.3 (c) | |
| Temp. range A ⁶ | Characteristic bond stress in cracked concrete ⁷ | T_{cr} | psi (MPa) | 625 (4.3) | 725 (5.0) | 775 (5.4) | 790 (5.4) | 800 (5.5) | D.6.5.2 |
| | Characteristic bond stress in uncracked concrete ⁷ | T_{unscr} | psi (MPa) | 1,275 (8.8) | 1,255 (8.7) | 1,240 (8.6) | 1,220 (8.4) | 1,095 (7.6) | D.6.5.2 |
| Temp. range B ⁶ | Characteristic bond stress in cracked concrete ⁷ | T_{cr} | psi (MPa) | 575 (4.0) | 665 (4.6) | 725 (4.9) | 725 (5.0) | 735 (5.1) | D.6.5.2 |
| | Characteristic bond stress in uncracked concrete ⁷ | T_{unscr} | psi (MPa) | 1,175 (8.1) | 1,155 (8.0) | 1,140 (7.9) | 1,120 (7.7) | 1,010 (7.0) | D.6.5.2 |
| Temp. range C ⁶ | Characteristic bond stress in cracked concrete ⁷ | T_{cr} | psi (MPa) | 440 (3.0) | 510 (3.5) | 545 (3.8) | 555 (3.8) | 560 (3.9) | D.6.5.2 |
| | Characteristic bond stress in uncracked concrete ⁷ | T_{unscr} | psi (MPa) | 915 (6.3) | 900 (6.2) | 885 (6.1) | 875 (6.0) | 785 (5.4) | D.6.5.2 |
| Reduction for seismic tension | | $\alpha_{N,seis}$ | - | 1.00 | | | | | |
| Permissible installation conditions | Resistance modification factor tension & shear, bond failure water-saturated concrete | Anchor category | - | 1 | | | 2 | | D.5.3 (c) |
| | | R_{ws} | - | 1.00 | | | 0.85 | | |

¹ Design information in this table is taken from ICC-ES ESR-3574, dated March 2018, table 20 and 21, and converted for use with CSA A23.3-14 Annex D.

² See figure at the beginning of the rebar section.

³ Minimum edge distance may be reduced to 45mm provided rebar remains untorqued. See ESR-3574 section 4.1.9.2.

⁴ For all design cases, $\psi_{c,N} = 1.0$. The appropriate coefficient for breakout resistance for cracked concrete ($k_{c,cr}$) or uncracked concrete ($k_{c,unscr}$) must be used.

⁵ For use with the load combinations of CSA A23.3-14 chapter 8. Condition B applies where supplementary reinforcement in conformance with CSA A23.3-14 section D.5.3 is not provided, or where pullout or pryout strength governs. For cases where the presence of supplementary reinforcement can be verified, the resistance modification factors associated with Condition A may be used.

⁶ Temperature range A: Max. short term temperature = 130°F (55°C), max. long term temperature = 110°F (43°C).

Temperature range B: Max. short term temperature = 176°F (80°C), max. long term temperature = 110°F (43°C).

Temperature range C: Max. short term temperature = 210°F (99°C), max. long term temperature = 162°F (72°C)

Short term elevated concrete temperatures are those that occur over brief intervals, e.g., as a result of diurnal cycling. Long term concrete temperatures are roughly constant over significant periods of time.

⁷ Bond strength values corresponding to concrete compressive strength $f'_c = 2,500$ psi (17.2 MPa). For concrete compressive strength, f'_c , between 2,500 psi (17.2 MPa) and 8,000 psi (55.2 MPa), the tabulated characteristic bond strength may be increased by a factor of $(f'_c / 2,500)^{0.1}$ [for SI: $(f'_c / 17.2)^{0.1}$].

Hilti HIT-HY 100 Adhesive with Deformed Reinforcing Bars (Rebar)



Table 40 — Hilti HIT-HY 100 adhesive factored resistance with concrete / bond failure for CA rebar in uncracked concrete ^{1,2,3,4,5,6,7,8}



| Rebar size | Effective embedment in. (mm) | Tension — N_r | | | | Shear — V_r | | | |
|------------|------------------------------|---|---|---|---|---|---|---|---|
| | | $f'_c = 20$ MPa (2,900 psi) lb (kN) | $f'_c = 25$ MPa (3,625 psi) lb (kN) | $f'_c = 30$ MPa (4,350 psi) lb (kN) | $f'_c = 40$ MPa (5,800 psi) lb (kN) | $f'_c = 20$ MPa (2,900 psi) lb (kN) | $f'_c = 25$ MPa (3,625 psi) lb (kN) | $f'_c = 30$ MPa (4,350 psi) lb (kN) | $f'_c = 40$ MPa (5,800 psi) lb (kN) |
| 10M | 4-1/2 (115) | 5,325 (23.7) | 5,445 (24.2) | 5,545 (24.7) | 5,710 (25.4) | 10,650 (47.4) | 10,890 (48.4) | 11,090 (49.3) | 11,415 (50.8) |
| | 7-1/16 (180) | 8,335 (37.1) | 8,525 (37.9) | 8,680 (38.6) | 8,935 (39.7) | 16,670 (74.2) | 17,045 (75.8) | 17,360 (77.2) | 17,865 (79.5) |
| | 8-7/8 (226) | 10,465 (46.6) | 10,700 (47.6) | 10,900 (48.5) | 11,215 (49.9) | 20,930 (93.1) | 21,405 (95.2) | 21,795 (97.0) | 22,435 (99.8) |
| 15M | 5-11/16 (145) | 9,360 (41.6) | 9,570 (42.6) | 9,745 (43.3) | 10,030 (44.6) | 18,715 (83.3) | 19,140 (85.1) | 19,490 (86.7) | 20,060 (89.2) |
| | 9-13/16 (250) | 16,135 (71.8) | 16,500 (73.4) | 16,800 (74.7) | 17,295 (76.9) | 32,270 (143.5) | 33,000 (146.8) | 33,605 (149.5) | 34,585 (153.8) |
| | 12-5/8 (320) | 20,655 (91.9) | 21,120 (93.9) | 21,505 (95.7) | 22,135 (98.5) | 41,305 (183.7) | 42,235 (187.9) | 43,015 (191.3) | 44,270 (196.9) |
| 20M | 7-7/8 (200) | 15,545 (69.1) | 15,895 (70.7) | 16,185 (72.0) | 16,660 (74.1) | 31,085 (138.3) | 31,790 (141.4) | 32,375 (144.0) | 33,320 (148.2) |
| | 14 (355) | 27,590 (122.7) | 28,210 (125.5) | 28,730 (127.8) | 29,570 (131.5) | 55,180 (245.4) | 56,425 (251.0) | 57,465 (255.6) | 59,140 (263.1) |
| | 15-3/8 (390) | 30,310 (134.8) | 30,995 (137.9) | 31,565 (140.4) | 32,485 (144.5) | 60,620 (269.6) | 61,985 (275.7) | 63,130 (280.8) | 64,970 (289.0) |
| 25M | 9-1/16 (230) | 22,725 (101.1) | 23,240 (103.4) | 23,670 (105.3) | 24,360 (108.4) | 45,455 (202.2) | 46,480 (206.8) | 47,335 (210.6) | 48,715 (216.7) |
| | 15-15/16 (405) | 40,020 (178.0) | 40,925 (182.0) | 41,675 (185.4) | 42,890 (190.8) | 80,040 (356.0) | 81,845 (364.1) | 83,350 (370.8) | 85,785 (381.6) |
| | 19-13/16 (504) | 49,805 (221.5) | 50,925 (226.5) | 51,865 (230.7) | 53,375 (237.4) | 99,605 (443.1) | 101,855 (453.1) | 103,725 (461.4) | 106,755 (474.9) |
| 30M | 10-1/4 (260) | 23,255 (103.4) | 23,780 (105.8) | 24,220 (107.7) | 24,925 (110.9) | 46,510 (206.9) | 47,560 (211.6) | 48,435 (215.5) | 49,850 (221.7) |
| | 17-15/16 (455) | 40,700 (181.0) | 41,615 (185.1) | 42,380 (188.5) | 43,620 (194.0) | 81,395 (362.1) | 83,235 (370.2) | 84,765 (377.1) | 87,240 (388.1) |
| | 23-9/16 (598) | 53,490 (237.9) | 54,695 (243.3) | 55,705 (247.8) | 57,330 (255.0) | 106,980 (475.9) | 109,390 (486.6) | 111,405 (495.6) | 114,655 (510.0) |

- 1 See Section 3.1.8 (2017 PTG) for explanation on development of load values.
- 2 See Section 3.1.8.6 (2017 PTG) to convert design strength value to ASD value.
- 3 Linear interpolation between embedment depths and concrete compressive strengths is not permitted.
- 4 Apply spacing, edge distance, and concrete thickness factors in tables 43-52 as necessary. Compare to the steel values in table 42. The lesser of the values is to be used for the design.
- 5 Data is for temperature range A: Max. short term temperature = 130°F (55°C), max. long term temperature = 110°F (43°C).
For temperature range B: Max. short term temperature = 176°F (80°C), max. long term temperature = 110°F (43°C) multiply above value by 0.92.
For temperature range C: Max. short term temperature = 210°F (99°C), max. long term temperature = 162°F (72°C) multiply above value by 0.71.
Short term elevated concrete temperatures are those that occur over brief intervals, e.g., as a result of diurnal cycling. Long term concrete temperatures are roughly constant over significant periods of time.
- 6 Tabular values are for dry concrete conditions. For water saturated concrete multiply design strength (factored resistance) by 0.85.
- 7 Tabular values are for short term loads only. For sustained loads including overhead use, see Section 3.1.8.8 (2017 PTG).
- 8 Tabular values are for normal-weight concrete only. For lightweight concrete multiply design strength by λ_a as follows:
For sand-lightweight, $\lambda_a = 0.51$. For all-lightweight, $\lambda_a = 0.45$.

Table 41 — Hilti HIT-HY 100 adhesive factored resistance with concrete / bond failure for CA rebar in cracked concrete 1,2,3,4,5,6,7,8,9



| Rebar size da (in) | Effective embedment in. (mm) h _{ef} (in) | Tension — N _t | | | | Shear — V _r | | | |
|-----------------------|--|--|--|--|--|--|--|--|--|
| | | f' _c = 20 MPa (2,900 psi) lb (kN) | f' _c = 25 MPa (3,625 psi) lb (kN) | f' _c = 30 MPa (4,350 psi) lb (kN) | f' _c = 40 MPa (5,800 psi) lb (kN) | f' _c = 20 MPa (2,900 psi) lb (kN) | f' _c = 25 MPa (3,625 psi) lb (kN) | f' _c = 30 MPa (4,350 psi) lb (kN) | f' _c = 40 MPa (5,800 psi) lb (kN) |
| | | 20 | 25 | 30 | 40 | 20 | 25 | 30 | 40 |
| 10M | 4-1/2 (115) | 2,610 (11.6) | 2,670 (11.9) | 2,720 (12.1) | 2,800 (12.4) | 5,220 (23.2) | 5,340 (23.7) | 5,435 (24.2) | 5,595 (24.9) |
| | 7-1/16 (180) | 4,085 (18.2) | 4,180 (18.6) | 4,255 (18.9) | 4,380 (19.5) | 8,170 (36.4) | 8,355 (37.2) | 8,510 (37.9) | 8,760 (39.0) |
| | 8-7/8 (226) | 5,130 (22.8) | 5,245 (23.3) | 5,340 (23.8) | 5,500 (24.5) | 10,260 (45.6) | 10,490 (46.7) | 10,685 (47.5) | 10,995 (48.9) |
| 15M | 5-11/16 (145) | 5,405 (24.0) | 5,530 (24.6) | 5,630 (25.0) | 5,795 (25.8) | 10,810 (48.1) | 11,055 (49.2) | 11,260 (50.1) | 11,590 (51.5) |
| | 9-13/16 (250) | 9,320 (41.5) | 9,530 (42.4) | 9,705 (43.2) | 9,990 (44.4) | 18,640 (82.9) | 19,065 (84.8) | 19,415 (86.4) | 19,980 (88.9) |
| | 12-5/8 (320) | 11,930 (53.1) | 12,200 (54.3) | 12,425 (55.3) | 12,785 (56.9) | 23,860 (106.1) | 24,400 (108.5) | 24,850 (110.5) | 25,575 (113.8) |
| 20M | 7-7/8 (200) | 9,715 (43.2) | 9,935 (44.2) | 10,115 (45.0) | 10,410 (46.3) | 19,430 (86.4) | 19,870 (88.4) | 20,235 (90.0) | 20,825 (92.6) |
| | 14 (355) | 17,245 (76.7) | 17,635 (78.4) | 17,955 (79.9) | 18,480 (82.2) | 34,485 (153.4) | 35,265 (156.9) | 35,915 (159.8) | 36,960 (164.4) |
| | 15-3/8 (390) | 18,945 (84.3) | 19,370 (86.2) | 19,725 (87.8) | 20,305 (90.3) | 37,885 (168.5) | 38,740 (172.3) | 39,455 (175.5) | 40,605 (180.6) |
| 25M | 9-1/16 (230) | 14,715 (65.5) | 15,050 (66.9) | 15,325 (68.2) | 15,775 (70.2) | 29,435 (130.9) | 30,100 (133.9) | 30,650 (136.3) | 31,545 (140.3) |
| | 15-15/16 (405) | 25,915 (115.3) | 26,500 (117.9) | 26,985 (120.0) | 27,775 (123.5) | 51,830 (230.5) | 53,000 (235.7) | 53,975 (240.1) | 55,550 (247.1) |
| | 19-13/16 (504) | 32,250 (143.5) | 32,975 (146.7) | 33,585 (149.4) | 34,565 (153.7) | 64,500 (286.9) | 65,955 (293.4) | 67,165 (298.8) | 69,130 (307.5) |
| 30M | 10-1/4 (260) | 16,990 (75.6) | 17,375 (77.3) | 17,695 (78.7) | 18,210 (81.0) | 33,980 (151.2) | 34,750 (154.6) | 35,390 (157.4) | 36,420 (162.0) |
| | 17-15/16 (455) | 29,735 (132.3) | 30,405 (135.2) | 30,965 (137.7) | 31,870 (141.8) | 59,470 (264.5) | 60,810 (270.5) | 61,930 (275.5) | 63,735 (283.5) |
| | 23-9/16 (598) | 39,080 (173.8) | 39,960 (177.8) | 40,695 (181.0) | 41,885 (186.3) | 78,160 (347.7) | 79,920 (355.5) | 81,390 (362.0) | 83,765 (372.6) |

- 1 See Section 3.1.8 (2017 PTG) for explanation on development of load values.
- 2 See Section 3.1.8.6 (2017 PTG) to convert design strength value to ASD value.
- 3 Linear interpolation between embedment depths and concrete compressive strengths is not permitted.
- 4 Apply spacing, edge distance, and concrete thickness factors in tables 43-52 as necessary. Compare to the steel values in table 42. The lesser of the values is to be used for the design.
- 5 Data is for temperature range A: Max. short term temperature = 130°F (55°C), max. long term temperature = 110°F (43°C).
For temperature range B: Max. short term temperature = 176°F (80°C), max. long term temperature = 110°F (43°C) multiply above value by 0.92.
For temperature range C: Max. short term temperature = 210°F (99°C), max. long term temperature = 162°F (72°C) multiply above value by 0.71.
Short term elevated concrete temperatures are those that occur over brief intervals, e.g., as a result of diurnal cycling. Long term concrete temperatures are roughly constant over significant periods of time.
- 6 Tabular values are for dry concrete conditions. For water saturated concrete multiply design strength (factored resistance) by 0.85.
- 7 Tabular values are for short term loads only. For sustained loads including overhead use, see Section 3.1.8.8 (2017 PTG).
- 8 Tabular values are for normal-weight concrete only. For lightweight concrete multiply design strength by λ_a as follows:
For sand-lightweight, λ_a = 0.51. For all-lightweight, λ_a = 0.45.
- 9 Tabular values are for static loads only. For seismic loads, multiply cracked concrete tabular values in tension and shear by α_{seis} = 0.75.

Table 42 – Steel factored resistance for CA rebar ¹



| Rebar size | CSA-G30.18 Grade 400 ² | | |
|------------|---|---|--|
| | Tensile ³ N _{sar} lb (kN) | Shear ⁴ V _{sar} lb (kN) | Seismic Shear ⁵ V _{sar,eq} lb (kN) |
| 10M | 7,245 (32.2) | 4,035 (17.9) | 2,825 (12.6) |
| 15M | 14,525 (64.6) | 8,090 (36.0) | 5,665 (25.2) |
| 20M | 21,570 (95.9) | 12,020 (53.5) | 8,415 (37.4) |
| 25M | 36,025 (160.2) | 20,070 (89.3) | 14,050 (62.5) |
| 30M | 50,715 (225.6) | 28,255 (125.7) | 19,780 (88.0) |

- 1 See Section 3.1.8.6 (2017 PTG) to convert design strength value to ASD value.
- 2 CSA-G30.18 Grade 400 rebar are considered ductile steel elements.
- 3 Tensile = $A_{sa,N} \phi_s f_{uta} R$ as noted in CSA A23.3-14 Annex D
- 4 Shear = $A_{sa,V} \phi_s 0.60 f_{uts}$ as noted in CSA A23.3-14 Annex D.
- 5 Seismic Shear = $\alpha_{v,seis} V_{sa}$; Reduction factor for seismic shear only. See section 3.1.8.7 for additional information on seismic applications.

Table 43 – Load adjustment factors for 10M rebar in uncracked concrete ^{1,2,3}



| 10M Uncracked concrete | Spacing factor in tension f_{AN} | | | Edge distance factor in tension f_{RN} | | | Spacing factor in shear ⁴ f_{AV} | | | Edge distance in shear | | | | | | Concrete thickness factor in shear ⁵ f_{HV} | | |
|---------------------------|---------------------------------------|----------------|-----------------|---|----------------|-----------------|--|----------------|-----------------|------------------------------|----------------|-----------------|--------------------------|----------------|-----------------|---|----------------|-----------------|
| | | | | | | | | | | ⊥ Toward edge f_{RV} | | | ∥ To edge f_{RV} | | | | | |
| | Embedment h_{ef} in (mm) | 4-1/2 (115) | 7-1/16 (180) | 8-7/8 (226) | 4-1/2 (115) | 7-1/16 (180) | 8-7/8 (226) | 4-1/2 (115) | 7-1/16 (180) | 8-8/9 (226) | 4-1/2 (115) | 7-1/16 (180) | 8-7/8 (226) | 4-1/2 (115) | 7-1/16 (180) | 8-7/8 (226) | 4-1/2 (115) | 7-1/16 (180) |
| 1-3/4 (44) | n/a | n/a | n/a | 0.25 | 0.16 | 0.12 | n/a | n/a | n/a | 0.08 | 0.05 | 0.04 | 0.15 | 0.10 | 0.08 | n/a | n/a | n/a |
| 2-3/16 (55) | 0.58 | 0.55 | 0.54 | 0.28 | 0.17 | 0.13 | 0.54 | 0.53 | 0.52 | 0.10 | 0.07 | 0.05 | 0.21 | 0.13 | 0.11 | n/a | n/a | n/a |
| 3 (76) | 0.61 | 0.57 | 0.56 | 0.33 | 0.20 | 0.16 | 0.55 | 0.54 | 0.53 | 0.17 | 0.11 | 0.09 | 0.33 | 0.20 | 0.16 | n/a | n/a | n/a |
| 4 (102) | 0.65 | 0.59 | 0.57 | 0.39 | 0.24 | 0.19 | 0.57 | 0.55 | 0.54 | 0.26 | 0.17 | 0.13 | 0.39 | 0.24 | 0.19 | n/a | n/a | n/a |
| 5 (127) | 0.68 | 0.62 | 0.59 | 0.46 | 0.29 | 0.23 | 0.59 | 0.56 | 0.55 | 0.37 | 0.24 | 0.19 | 0.46 | 0.29 | 0.23 | n/a | n/a | n/a |
| 5-11/16 (145) | 0.71 | 0.63 | 0.61 | 0.53 | 0.33 | 0.26 | 0.60 | 0.57 | 0.56 | 0.45 | 0.29 | 0.23 | 0.53 | 0.33 | 0.26 | 0.63 | n/a | n/a |
| 6 (152) | 0.72 | 0.64 | 0.61 | 0.56 | 0.35 | 0.27 | 0.60 | 0.58 | 0.57 | 0.48 | 0.31 | 0.25 | 0.56 | 0.35 | 0.27 | 0.64 | n/a | n/a |
| 7 (178) | 0.76 | 0.66 | 0.63 | 0.65 | 0.40 | 0.32 | 0.62 | 0.59 | 0.58 | 0.61 | 0.39 | 0.31 | 0.65 | 0.40 | 0.32 | 0.69 | n/a | n/a |
| 8 (203) | 0.79 | 0.69 | 0.65 | 0.74 | 0.46 | 0.36 | 0.64 | 0.60 | 0.59 | 0.75 | 0.48 | 0.38 | 0.74 | 0.46 | 0.36 | 0.74 | n/a | n/a |
| 8-1/4 (210) | 0.80 | 0.69 | 0.65 | 0.77 | 0.48 | 0.37 | 0.64 | 0.61 | 0.59 | 0.78 | 0.50 | 0.40 | 0.77 | 0.48 | 0.37 | 0.75 | 0.65 | n/a |
| 9 (229) | 0.83 | 0.71 | 0.67 | 0.83 | 0.52 | 0.41 | 0.65 | 0.61 | 0.60 | 0.89 | 0.57 | 0.45 | 0.83 | 0.52 | 0.41 | 0.79 | 0.68 | n/a |
| 10-1/16 (256) | 0.87 | 0.74 | 0.69 | 0.93 | 0.58 | 0.46 | 0.67 | 0.63 | 0.61 | 1.00 | 0.67 | 0.54 | 0.93 | 0.58 | 0.46 | 0.83 | 0.72 | 0.66 |
| 11 (279) | 0.90 | 0.76 | 0.71 | 1.00 | 0.63 | 0.50 | 0.69 | 0.64 | 0.62 | | 0.77 | 0.61 | 1.00 | 0.63 | 0.50 | 0.87 | 0.75 | 0.69 |
| 12 (305) | 0.94 | 0.78 | 0.72 | | 0.69 | 0.54 | 0.71 | 0.65 | 0.63 | | 0.88 | 0.70 | | 0.69 | 0.54 | 0.91 | 0.78 | 0.72 |
| 14 (356) | 1.00 | 0.83 | 0.76 | | 0.81 | 0.63 | 0.74 | 0.68 | 0.65 | | 1.00 | 0.88 | | 0.81 | 0.63 | 0.98 | 0.84 | 0.78 |
| 16 (406) | | 0.88 | 0.80 | | 0.92 | 0.73 | 0.77 | 0.70 | 0.67 | | | 1.00 | | 0.92 | 0.73 | 1.00 | 0.90 | 0.84 |
| 18 (457) | | 0.92 | 0.84 | | 1.00 | 0.82 | 0.81 | 0.73 | 0.70 | | | | | 1.00 | 0.82 | | 0.96 | 0.89 |
| 24 (610) | | 1.00 | 0.95 | | | 1.00 | 0.91 | 0.81 | 0.76 | | | | | | 1.00 | | 1.00 | 1.00 |
| 30 (762) | | | 1.00 | | | | 1.00 | 0.88 | 0.83 | | | | | | | | | |
| 36 (914) | | | | | | | | 0.96 | 0.89 | | | | | | | | | |
| > 48 (1219) | | | | | | | | 1.00 | 1.00 | | | | | | | | | |

- 1 Linear interpolation not permitted
- 2 Shaded area with reduced edge distance is permitted provided the rebar has no installation torque.
- 3 When combining multiple load adjustment factors (e.g. for a four-anchor pattern in a corner with thin concrete member) the design can become very conservative. To optimize the design, use Hilti PROFIS Anchor Design software or perform anchor calculation using design equations from CSA A23.3-14 Annex D.
- 4 Spacing factor reduction in shear applicable when $c_a < 3^*h_{ef}$, is applicable when edge distance, $c_a < 3^*h_{ef}$. If $c_a \geq 3^*h_{ef}$, then $f_{AV} = f_{AN}$.
- 5 Concrete thickness reduction factor in shear, f_{HV} , is applicable when edge distance, $c_a < 3^*h_{ef}$. If $c_a \geq 3^*h_{ef}$, then $f_{HV} = 1.0$.

Table 44 – Load adjustment factors for 10M rebar in cracked concrete ^{1,2,3}

| 10M Cracked concrete | Spacing factor in tension f_{AN} | | | Edge distance factor in tension f_{RN} | | | Spacing factor in shear ⁴ f_{AV} | | | Edge distance in shear | | | | | | Concrete thickness factor in shear ⁵ f_{HV} | | | |
|---|---------------------------------------|----------------|-----------------|---|----------------|-----------------|--|----------------|-----------------|------------------------------|----------------|-----------------|--------------------------|----------------|-----------------|---|----------------|-----------------|----------------|
| | | | | | | | | | | ⊥ Toward edge f_{RV} | | | ∥ To edge f_{RV} | | | | | | |
| | Embedment h_{ef} in (mm) | 4-1/2 (115) | 7-1/16 (180) | 8-7/8 (226) | 4-1/2 (115) | 7-1/16 (180) | 8-7/8 (226) | 4-1/2 (115) | 7-1/16 (180) | 8-8/9 (226) | 4-1/2 (115) | 7-1/16 (180) | 8-7/8 (226) | 4-1/2 (115) | 7-1/16 (180) | 8-7/8 (226) | 4-1/2 (115) | 7-1/16 (180) | 8-7/8 (226) |
| Spacing (s) / edge distance (c_e) / concrete thickness (h), - in (mm) | 1-3/4 (44) | n/a | n/a | n/a | 0.49 | 0.44 | 0.42 | n/a | n/a | n/a | 0.07 | 0.05 | 0.04 | 0.15 | 0.09 | 0.07 | n/a | n/a | n/a |
| | 2-3/16 (55) | 0.58 | 0.55 | 0.54 | 0.52 | 0.46 | 0.43 | 0.54 | 0.53 | 0.52 | 0.10 | 0.06 | 0.05 | 0.20 | 0.13 | 0.10 | n/a | n/a | n/a |
| | 3 (76) | 0.61 | 0.57 | 0.56 | 0.60 | 0.50 | 0.47 | 0.55 | 0.54 | 0.53 | 0.16 | 0.10 | 0.08 | 0.33 | 0.21 | 0.17 | n/a | n/a | n/a |
| | 4 (102) | 0.65 | 0.59 | 0.57 | 0.70 | 0.56 | 0.51 | 0.57 | 0.55 | 0.54 | 0.25 | 0.16 | 0.13 | 0.51 | 0.32 | 0.26 | n/a | n/a | n/a |
| | 5 (127) | 0.68 | 0.62 | 0.59 | 0.80 | 0.62 | 0.56 | 0.58 | 0.56 | 0.55 | 0.35 | 0.23 | 0.18 | 0.71 | 0.45 | 0.36 | n/a | n/a | n/a |
| | 5-11/16 (145) | 0.71 | 0.63 | 0.61 | 0.88 | 0.66 | 0.59 | 0.60 | 0.57 | 0.56 | 0.43 | 0.28 | 0.22 | 0.86 | 0.55 | 0.44 | 0.62 | n/a | n/a |
| | 6 (152) | 0.72 | 0.64 | 0.61 | 0.91 | 0.68 | 0.61 | 0.60 | 0.57 | 0.56 | 0.46 | 0.30 | 0.24 | 0.91 | 0.59 | 0.47 | 0.63 | n/a | n/a |
| | 7 (178) | 0.76 | 0.66 | 0.63 | 1.00 | 0.74 | 0.65 | 0.62 | 0.59 | 0.57 | 0.59 | 0.37 | 0.30 | 1.00 | 0.74 | 0.60 | 0.68 | n/a | n/a |
| | 8 (203) | 0.79 | 0.69 | 0.65 | | 0.81 | 0.70 | 0.63 | 0.60 | 0.58 | 0.72 | 0.46 | 0.36 | | 0.81 | 0.70 | 0.73 | n/a | n/a |
| | 8-1/4 (210) | 0.80 | 0.69 | 0.65 | | 0.83 | 0.72 | 0.64 | 0.60 | 0.59 | 0.75 | 0.48 | 0.38 | | 0.83 | 0.72 | 0.74 | 0.64 | n/a |
| | 9 (229) | 0.83 | 0.71 | 0.67 | | 0.88 | 0.76 | 0.65 | 0.61 | 0.60 | 0.85 | 0.55 | 0.43 | | 0.88 | 0.76 | 0.77 | 0.67 | n/a |
| | 10-1/16 (256) | 0.87 | 0.74 | 0.69 | | 0.96 | 0.81 | 0.67 | 0.62 | 0.61 | 1.00 | 0.65 | 0.51 | | 0.96 | 0.81 | 0.82 | 0.71 | 0.65 |
| | 11 (279) | 0.90 | 0.76 | 0.71 | | 1.00 | 0.86 | 0.68 | 0.64 | 0.62 | | 0.74 | 0.59 | | 1.00 | 0.86 | 0.86 | 0.74 | 0.68 |
| | 12 (305) | 0.94 | 0.78 | 0.72 | | | 0.92 | 0.70 | 0.65 | 0.63 | | 0.84 | 0.67 | | | 0.92 | 0.89 | 0.77 | 0.71 |
| | 14 (356) | 1.00 | 0.83 | 0.76 | | | 1.00 | 0.73 | 0.67 | 0.65 | | 1.00 | 0.84 | | | 1.00 | 0.97 | 0.83 | 0.77 |
| | 16 (406) | | 0.88 | 0.80 | | | | 0.77 | 0.70 | 0.67 | | | 1.00 | | | | 1.00 | 0.89 | 0.82 |
| | 18 (457) | | 0.92 | 0.84 | | | | 0.80 | 0.72 | 0.69 | | | | | | | | 0.94 | 0.87 |
| | 24 (610) | | 1.00 | 0.95 | | | | 0.90 | 0.80 | 0.75 | | | | | | | | 1.00 | 1.00 |
| | 30 (762) | | | 1.00 | | | | 1.00 | 0.87 | 0.82 | | | | | | | | | |
| 36 (914) | | | | | | | | 0.95 | 0.88 | | | | | | | | | | |
| > 48 (1219) | | | | | | | | 1.00 | 1.00 | | | | | | | | | | |

Table 45 – Load adjustment factors for 15M rebar in uncracked concrete ^{1,2,3}

| 15M Uncracked concrete | Spacing factor in tension f_{AN} | | | Edge distance factor in tension f_{RN} | | | Spacing factor in shear ⁴ f_{AV} | | | Edge distance in shear | | | | | | Concrete thickness factor in shear ⁵ f_{HV} | | | |
|---|---------------------------------------|------------------|------------------|---|------------------|------------------|--|------------------|------------------|------------------------------|------------------|------------------|--------------------------|------------------|------------------|---|------------------|------------------|-----------------|
| | | | | | | | | | | ⊥ Toward edge f_{RV} | | | ∥ To edge f_{RV} | | | | | | |
| | Embedment h_{ef} in (mm) | 5-11/16 (145) | 9-13/16 (250) | 12-5/8 (320) | 5-11/16 (145) | 9-13/16 (250) | 12-5/8 (320) | 5-11/16 (145) | 9-13/16 (250) | 12-5/8 (320) | 5-11/16 (145) | 9-13/16 (250) | 12-5/8 (320) | 5-11/16 (145) | 9-13/16 (250) | 12-5/8 (320) | 5-11/16 (145) | 9-13/16 (250) | 12-5/8 (320) |
| Spacing (s) / edge distance (c_e) / concrete thickness (h), - in (mm) | 1-3/4 (44) | n/a | n/a | n/a | 0.25 | 0.14 | 0.11 | n/a | n/a | n/a | 0.05 | 0.03 | 0.02 | 0.10 | 0.06 | 0.05 | n/a | n/a | n/a |
| | 3-1/8 (80) | 0.59 | 0.55 | 0.54 | 0.31 | 0.18 | 0.14 | 0.54 | 0.53 | 0.52 | 0.12 | 0.07 | 0.06 | 0.25 | 0.14 | 0.11 | n/a | n/a | n/a |
| | 4 (102) | 0.62 | 0.57 | 0.55 | 0.36 | 0.20 | 0.15 | 0.55 | 0.54 | 0.53 | 0.18 | 0.10 | 0.08 | 0.36 | 0.20 | 0.15 | n/a | n/a | n/a |
| | 5 (127) | 0.65 | 0.58 | 0.57 | 0.41 | 0.23 | 0.18 | 0.57 | 0.55 | 0.54 | 0.25 | 0.14 | 0.11 | 0.41 | 0.23 | 0.18 | n/a | n/a | n/a |
| | 6 (152) | 0.68 | 0.60 | 0.58 | 0.46 | 0.26 | 0.20 | 0.58 | 0.56 | 0.55 | 0.33 | 0.19 | 0.15 | 0.46 | 0.26 | 0.20 | n/a | n/a | n/a |
| | 7 (178) | 0.70 | 0.62 | 0.59 | 0.52 | 0.29 | 0.22 | 0.59 | 0.56 | 0.55 | 0.41 | 0.24 | 0.19 | 0.52 | 0.29 | 0.22 | n/a | n/a | n/a |
| | 7-1/4 (184) | 0.71 | 0.62 | 0.60 | 0.54 | 0.30 | 0.23 | 0.60 | 0.57 | 0.56 | 0.44 | 0.25 | 0.20 | 0.54 | 0.30 | 0.23 | 0.62 | n/a | n/a |
| | 8 (203) | 0.73 | 0.64 | 0.61 | 0.59 | 0.33 | 0.26 | 0.61 | 0.57 | 0.56 | 0.51 | 0.29 | 0.23 | 0.59 | 0.33 | 0.26 | 0.65 | n/a | n/a |
| | 9 (229) | 0.76 | 0.65 | 0.62 | 0.67 | 0.37 | 0.29 | 0.62 | 0.58 | 0.57 | 0.60 | 0.35 | 0.27 | 0.67 | 0.37 | 0.29 | 0.69 | n/a | n/a |
| | 10 (254) | 0.79 | 0.67 | 0.63 | 0.74 | 0.42 | 0.32 | 0.63 | 0.59 | 0.58 | 0.71 | 0.41 | 0.32 | 0.74 | 0.42 | 0.32 | 0.73 | n/a | n/a |
| | 11-3/8 (289) | 0.83 | 0.69 | 0.65 | 0.84 | 0.47 | 0.37 | 0.65 | 0.60 | 0.59 | 0.86 | 0.50 | 0.39 | 0.84 | 0.47 | 0.37 | 0.78 | 0.65 | n/a |
| | 12 (305) | 0.85 | 0.70 | 0.66 | 0.89 | 0.50 | 0.39 | 0.66 | 0.61 | 0.59 | 0.93 | 0.54 | 0.42 | 0.89 | 0.50 | 0.39 | 0.80 | 0.66 | n/a |
| | 14-1/8 (359) | 0.91 | 0.74 | 0.69 | 1.00 | 0.59 | 0.45 | 0.69 | 0.63 | 0.61 | 1.00 | 0.69 | 0.54 | 1.00 | 0.59 | 0.45 | 0.86 | 0.72 | 0.66 |
| | 16 (406) | 0.97 | 0.77 | 0.71 | | 0.66 | 0.51 | 0.71 | 0.65 | 0.62 | | 0.83 | 0.65 | | 0.66 | 0.51 | 0.92 | 0.77 | 0.71 |
| | 18 (457) | 1.00 | 0.80 | 0.74 | | 0.75 | 0.58 | 0.74 | 0.67 | 0.64 | | 0.99 | 0.77 | | 0.75 | 0.58 | 0.98 | 0.81 | 0.75 |
| | 20 (508) | | 0.84 | 0.76 | | 0.83 | 0.64 | 0.76 | 0.68 | 0.66 | | 1.00 | 0.91 | | 0.83 | 0.64 | 1.00 | 0.86 | 0.79 |
| | 22 (559) | | 0.87 | 0.79 | | 0.91 | 0.71 | 0.79 | 0.70 | 0.67 | | | 1.00 | | 0.91 | 0.71 | | 0.90 | 0.83 |
| | 24 (610) | | 0.91 | 0.82 | | 1.00 | 0.77 | 0.82 | 0.72 | 0.69 | | | | | 1.00 | 0.77 | | 0.94 | 0.87 |
| | 30 (762) | | 1.00 | 0.90 | | | 0.96 | 0.90 | 0.78 | 0.73 | | | | | | 0.96 | | 1.00 | 0.97 |
| 36 (914) | | | 0.98 | | | 1.00 | 0.98 | 0.83 | 0.78 | | | | | | 1.00 | | | 1.00 | |
| > 48 (1219) | | | 1.00 | | | | 1.00 | 0.94 | 0.87 | | | | | | | | | | |

1 Linear interpolation not permitted

2 Shaded area with reduced edge distance is permitted provided the rebar has no installation torque.

3 When combining multiple load adjustment factors (e.g. for a four-anchor pattern in a corner with thin concrete member) the design can become very conservative. To optimize the design, use Hilti PROFIS Anchor Design software or perform anchor calculation using design equations from CSA A23.3-14 Annex D.

4 Spacing factor reduction in shear applicable when $c_e < 3 \cdot h_{ef}$. f_{AV} is applicable when edge distance, $c_e < 3 \cdot h_{ef}$. If $c_e \geq 3 \cdot h_{ef}$, then $f_{AV} = f_{AN}$.

5 Concrete thickness reduction factor in shear, f_{HV} is applicable when edge distance, $c_e < 3 \cdot h_{ef}$. If $c_e \geq 3 \cdot h_{ef}$, then $f_{HV} = 1.0$.



Table 46 – Load adjustment factors for 15M rebar in cracked concrete ^{1,2,3}

| 15M Cracked concrete | Spacing factor in tension | | | Edge distance factor in tension | | | Spacing factor in shear ⁴ | | | Edge distance in shear | | | | | | Concrete thickness factor in shear ⁵ | | | |
|--|-------------------------------|------------------|------------------|---------------------------------|------------------|------------------|--------------------------------------|------------------|------------------|------------------------------|------------------|------------------|--------------------------|------------------|------------------|---|------------------|------------------|-----------------|
| | f_{AN} | | | f_{RN} | | | f_{AV} | | | ⊥ Toward edge f_{RV} | | | ∥ To edge f_{RV} | | | f_{HV} | | | |
| | Embedment h_{ef} in (mm) | 5-11/16 (145) | 9-13/16 (250) | 12-5/8 (320) | 5-11/16 (145) | 9-13/16 (250) | 12-5/8 (320) | 5-11/16 (145) | 9-13/16 (250) | 12-5/8 (320) | 5-11/16 (145) | 9-13/16 (250) | 12-5/8 (320) | 5-11/16 (145) | 9-13/16 (250) | 12-5/8 (320) | 5-11/16 (145) | 9-13/16 (250) | 12-5/8 (320) |
| Spacing (s) / edge distance (c_e) / concrete thickness (h_c) - in (mm) | 1-3/4 (44) | n/a | n/a | n/a | 0.46 | 0.41 | 0.40 | n/a | n/a | n/a | 0.05 | 0.03 | 0.02 | 0.10 | 0.06 | 0.04 | n/a | n/a | n/a |
| | 3-1/8 (80) | 0.59 | 0.55 | 0.54 | 0.55 | 0.46 | 0.44 | 0.54 | 0.53 | 0.52 | 0.12 | 0.07 | 0.05 | 0.24 | 0.14 | 0.11 | n/a | n/a | n/a |
| | 4 (102) | 0.62 | 0.57 | 0.55 | 0.62 | 0.50 | 0.46 | 0.55 | 0.54 | 0.53 | 0.17 | 0.10 | 0.08 | 0.34 | 0.20 | 0.15 | n/a | n/a | n/a |
| | 5 (127) | 0.65 | 0.58 | 0.57 | 0.69 | 0.54 | 0.49 | 0.56 | 0.54 | 0.54 | 0.24 | 0.14 | 0.11 | 0.47 | 0.27 | 0.21 | n/a | n/a | n/a |
| | 6 (152) | 0.68 | 0.60 | 0.58 | 0.77 | 0.58 | 0.52 | 0.58 | 0.55 | 0.55 | 0.31 | 0.18 | 0.14 | 0.62 | 0.36 | 0.28 | n/a | n/a | n/a |
| | 7 (178) | 0.70 | 0.62 | 0.59 | 0.86 | 0.62 | 0.56 | 0.59 | 0.56 | 0.55 | 0.39 | 0.23 | 0.18 | 0.78 | 0.45 | 0.35 | n/a | n/a | n/a |
| | 7-1/4 (184) | 0.71 | 0.62 | 0.60 | 0.88 | 0.63 | 0.56 | 0.59 | 0.56 | 0.55 | 0.41 | 0.24 | 0.19 | 0.82 | 0.48 | 0.37 | 0.61 | n/a | n/a |
| | 8 (203) | 0.73 | 0.64 | 0.61 | 0.95 | 0.66 | 0.59 | 0.60 | 0.57 | 0.56 | 0.48 | 0.28 | 0.22 | 0.95 | 0.55 | 0.43 | 0.64 | n/a | n/a |
| | 9 (229) | 0.76 | 0.65 | 0.62 | 1.00 | 0.71 | 0.62 | 0.61 | 0.58 | 0.57 | 0.57 | 0.33 | 0.26 | 1.00 | 0.66 | 0.52 | 0.68 | n/a | n/a |
| | 10 (254) | 0.79 | 0.67 | 0.63 | | 0.76 | 0.66 | 0.63 | 0.59 | 0.58 | 0.67 | 0.39 | 0.30 | | 0.76 | 0.60 | 0.71 | n/a | n/a |
| | 11-3/8 (289) | 0.83 | 0.69 | 0.65 | | 0.82 | 0.71 | 0.64 | 0.60 | 0.59 | 0.81 | 0.47 | 0.37 | | 0.82 | 0.71 | 0.76 | 0.63 | n/a |
| | 12 (305) | 0.85 | 0.70 | 0.66 | | 0.86 | 0.73 | 0.65 | 0.61 | 0.59 | 0.88 | 0.51 | 0.40 | | 0.86 | 0.73 | 0.78 | 0.65 | n/a |
| | 14-1/8 (359) | 0.91 | 0.74 | 0.69 | | 0.97 | 0.81 | 0.68 | 0.63 | 0.61 | 1.00 | 0.65 | 0.51 | | 0.97 | 0.81 | 0.85 | 0.71 | 0.65 |
| | 16 (406) | 0.97 | 0.77 | 0.71 | | 1.00 | 0.88 | 0.70 | 0.64 | 0.62 | | 0.78 | 0.61 | | 1.00 | 0.88 | 0.90 | 0.75 | 0.69 |
| | 18 (457) | 1.00 | 0.80 | 0.74 | | | 0.96 | 0.73 | 0.66 | 0.64 | | 0.93 | 0.73 | | | 0.96 | 0.96 | 0.80 | 0.73 |
| | 20 (508) | | 0.84 | 0.76 | | | 1.00 | 0.75 | 0.68 | 0.65 | | 1.00 | 0.85 | | | 1.00 | 1.00 | 0.84 | 0.77 |
| | 22 (559) | | 0.87 | 0.79 | | | | 0.78 | 0.69 | 0.67 | | | 0.99 | | | | | 0.88 | 0.81 |
| | 24 (610) | | 0.91 | 0.82 | | | | 0.81 | 0.71 | 0.68 | | | 1.00 | | | | | 0.92 | 0.85 |
| | 30 (762) | | 1.00 | 0.90 | | | | 0.88 | 0.77 | 0.73 | | | | | | | | 1.00 | 0.95 |
| | 36 (914) | | | 0.98 | | | | 0.96 | 0.82 | 0.77 | | | | | | | | | 1.00 |
| > 48 (1219) | | | 1.00 | | | | 1.00 | 0.92 | 0.86 | | | | | | | | | | |

Table 47 – Load adjustment factors for 20M rebar in uncracked concrete ^{1,2,3}



| 20M Uncracked concrete | Spacing factor in tension | | | Edge distance factor in tension | | | Spacing factor in shear ⁴ | | | Edge distance in shear | | | | | | Concrete thickness factor in shear ⁵ | | | |
|--|-------------------------------|----------------|-------------|---------------------------------|----------------|-------------|--------------------------------------|----------------|-------------|------------------------------|----------------|-------------|--------------------------|----------------|-------------|---|----------------|-------------|-----------------|
| | f_{AN} | | | f_{RN} | | | f_{AV} | | | ⊥ Toward edge f_{RV} | | | ∥ To edge f_{RV} | | | f_{HV} | | | |
| | Embedment h_{ef} in (mm) | 7-7/8 (200) | 14 (355) | 15-3/8 (390) | 7-7/8 (200) | 14 (355) | 15-3/8 (390) | 7-7/8 (200) | 14 (355) | 15-3/8 (390) | 7-7/8 (200) | 14 (355) | 15-3/8 (390) | 7-7/8 (200) | 14 (355) | 15-3/8 (390) | 7-7/8 (200) | 14 (355) | 15-3/8 (390) |
| Spacing (s) / edge distance (c_e) / concrete thickness (h_c) - in (mm) | 1-3/4 (44) | n/a | n/a | n/a | 0.21 | 0.11 | 0.10 | n/a | n/a | n/a | 0.03 | 0.02 | 0.02 | 0.07 | 0.04 | 0.03 | n/a | n/a | n/a |
| | 3-7/8 (98) | 0.58 | 0.55 | 0.54 | 0.28 | 0.15 | 0.14 | 0.54 | 0.53 | 0.52 | 0.11 | 0.06 | 0.06 | 0.22 | 0.12 | 0.11 | n/a | n/a | n/a |
| | 4 (102) | 0.58 | 0.55 | 0.54 | 0.28 | 0.15 | 0.14 | 0.54 | 0.53 | 0.53 | 0.11 | 0.06 | 0.06 | 0.23 | 0.13 | 0.12 | n/a | n/a | n/a |
| | 5 (127) | 0.61 | 0.56 | 0.55 | 0.32 | 0.17 | 0.16 | 0.55 | 0.53 | 0.53 | 0.16 | 0.09 | 0.08 | 0.32 | 0.17 | 0.16 | n/a | n/a | n/a |
| | 6 (152) | 0.63 | 0.57 | 0.57 | 0.36 | 0.19 | 0.18 | 0.56 | 0.54 | 0.54 | 0.21 | 0.12 | 0.11 | 0.36 | 0.19 | 0.18 | n/a | n/a | n/a |
| | 7 (178) | 0.65 | 0.58 | 0.58 | 0.39 | 0.21 | 0.19 | 0.57 | 0.55 | 0.54 | 0.27 | 0.15 | 0.14 | 0.39 | 0.21 | 0.19 | n/a | n/a | n/a |
| | 8 (203) | 0.67 | 0.60 | 0.59 | 0.44 | 0.24 | 0.22 | 0.58 | 0.55 | 0.55 | 0.32 | 0.18 | 0.17 | 0.44 | 0.24 | 0.22 | n/a | n/a | n/a |
| | 9 (229) | 0.69 | 0.61 | 0.60 | 0.48 | 0.26 | 0.24 | 0.59 | 0.56 | 0.56 | 0.39 | 0.22 | 0.20 | 0.48 | 0.26 | 0.24 | n/a | n/a | n/a |
| | 10 (254) | 0.71 | 0.62 | 0.61 | 0.54 | 0.29 | 0.27 | 0.60 | 0.57 | 0.56 | 0.45 | 0.26 | 0.23 | 0.54 | 0.29 | 0.27 | 0.63 | n/a | n/a |
| | 11 (279) | 0.73 | 0.63 | 0.62 | 0.59 | 0.32 | 0.29 | 0.61 | 0.57 | 0.57 | 0.52 | 0.29 | 0.27 | 0.59 | 0.32 | 0.29 | 0.66 | n/a | n/a |
| | 12 (305) | 0.75 | 0.64 | 0.63 | 0.65 | 0.35 | 0.32 | 0.62 | 0.58 | 0.58 | 0.60 | 0.34 | 0.31 | 0.65 | 0.35 | 0.32 | 0.69 | n/a | n/a |
| | 14 (356) | 0.80 | 0.67 | 0.65 | 0.75 | 0.41 | 0.37 | 0.64 | 0.59 | 0.59 | 0.75 | 0.42 | 0.39 | 0.75 | 0.41 | 0.37 | 0.74 | n/a | n/a |
| | 16 (406) | 0.84 | 0.69 | 0.67 | 0.86 | 0.47 | 0.42 | 0.66 | 0.61 | 0.60 | 0.92 | 0.52 | 0.47 | 0.86 | 0.47 | 0.42 | 0.79 | 0.66 | n/a |
| | 18 (457) | 0.88 | 0.71 | 0.70 | 0.97 | 0.53 | 0.48 | 0.68 | 0.62 | 0.61 | 1.00 | 0.62 | 0.56 | 0.97 | 0.53 | 0.48 | 0.84 | 0.70 | 0.67 |
| | 20 (508) | 0.92 | 0.74 | 0.72 | 1.00 | 0.59 | 0.53 | 0.70 | 0.63 | 0.63 | | 0.72 | 0.66 | 1.00 | 0.59 | 0.53 | 0.89 | 0.73 | 0.71 |
| | 22 (559) | 0.97 | 0.76 | 0.74 | | 0.64 | 0.58 | 0.72 | 0.65 | 0.64 | | 0.83 | 0.76 | | 0.64 | 0.58 | 0.93 | 0.77 | 0.74 |
| | 24 (610) | 1.00 | 0.79 | 0.76 | | 0.70 | 0.64 | 0.74 | 0.66 | 0.65 | | 0.95 | 0.86 | | 0.70 | 0.64 | 0.97 | 0.80 | 0.78 |
| | 26 (660) | | 0.81 | 0.78 | | 0.76 | 0.69 | 0.76 | 0.67 | 0.66 | | 1.00 | 0.98 | | 0.76 | 0.69 | 1.00 | 0.84 | 0.81 |
| | 28 (711) | | 0.83 | 0.80 | | 0.82 | 0.74 | 0.78 | 0.69 | 0.68 | | | 1.00 | | 0.82 | 0.74 | | 0.87 | 0.84 |
| | 30 (762) | | 0.86 | 0.83 | | 0.88 | 0.80 | 0.80 | 0.70 | 0.69 | | | | | 0.88 | 0.80 | | 0.90 | 0.87 |
| 36 (914) | | 0.93 | 0.89 | | 1.00 | 0.96 | 0.85 | 0.74 | 0.73 | | | | | 1.00 | 0.96 | | 0.98 | 0.95 | |
| > 48 (1219) | | 1.00 | 1.00 | | | 1.00 | 0.97 | 0.82 | 0.80 | | | | | | 1.00 | | 1.00 | 1.00 | |

1 Linear interpolation not permitted
 2 Shaded area with reduced edge distance is permitted provided the rebar has no installation torque.
 3 When combining multiple load adjustment factors (e.g. for a four-anchor pattern in a corner with thin concrete member) the design can become very conservative. To optimize the design, use Hilti PROFIS Anchor Design software or perform anchor calculation using design equations from CSA A23.3-14 Annex D.
 4 Spacing factor reduction in shear applicable when $c_e < 3 \cdot h_{ef}$, f_{AV} is applicable when edge distance, $c_a < 3 \cdot h_{ef}$. If $c_e \geq 3 \cdot h_{ef}$, then $f_{AV} = f_{AN}$.
 5 Concrete thickness reduction factor in shear, f_{HV} is applicable when edge distance, $c_a < 3 \cdot h_{ef}$. If $c_a \geq 3 \cdot h_{ef}$, then $f_{HV} = 1.0$.

Table 48 – Load adjustment factors for 20M rebar in cracked concrete ^{1,2,3}

| 20M Cracked concrete | Spacing factor in tension f_{AN} | | | Edge distance factor in tension f_{RN} | | | Spacing factor in shear ⁴ f_{AV} | | | Edge distance in shear | | | | | | Concrete thickness factor in shear ⁵ f_{HV} | | | |
|---|---------------------------------------|----------------|-------------|---|----------------|-------------|--|----------------|-------------|------------------------------|----------------|-------------|--------------------------|----------------|-------------|---|----------------|-------------|-----------------|
| | | | | | | | | | | ⊥ Toward edge f_{RV} | | | ∥ To edge f_{RV} | | | | | | |
| | Embedment h_{ef} in (mm) | 7-7/8 (200) | 14 (355) | 15-3/8 (390) | 7-7/8 (200) | 14 (355) | 15-3/8 (390) | 7-7/8 (200) | 14 (355) | 15-3/8 (390) | 7-7/8 (200) | 14 (355) | 15-3/8 (390) | 7-7/8 (200) | 14 (355) | 15-3/8 (390) | 7-7/8 (200) | 14 (355) | 15-3/8 (390) |
| Spacing (s) / edge distance (c_a) / concrete thickness (h_c), - in (mm) | 1-3/4 (44) | n/a | n/a | n/a | 0.43 | 0.39 | 0.39 | n/a | n/a | n/a | 0.03 | 0.02 | 0.02 | 0.06 | 0.03 | 0.03 | n/a | n/a | n/a |
| | 3-7/8 (98) | 0.58 | 0.55 | 0.54 | 0.53 | 0.45 | 0.44 | 0.54 | 0.52 | 0.52 | 0.10 | 0.06 | 0.05 | 0.20 | 0.11 | 0.10 | n/a | n/a | n/a |
| | 4 (102) | 0.58 | 0.55 | 0.54 | 0.54 | 0.45 | 0.44 | 0.54 | 0.53 | 0.52 | 0.11 | 0.06 | 0.05 | 0.21 | 0.12 | 0.11 | n/a | n/a | n/a |
| | 5 (127) | 0.61 | 0.56 | 0.55 | 0.59 | 0.48 | 0.47 | 0.55 | 0.53 | 0.53 | 0.15 | 0.08 | 0.08 | 0.30 | 0.17 | 0.15 | n/a | n/a | n/a |
| | 6 (152) | 0.63 | 0.57 | 0.57 | 0.64 | 0.51 | 0.49 | 0.56 | 0.54 | 0.54 | 0.20 | 0.11 | 0.10 | 0.39 | 0.22 | 0.20 | n/a | n/a | n/a |
| | 7 (178) | 0.65 | 0.58 | 0.58 | 0.70 | 0.53 | 0.52 | 0.57 | 0.54 | 0.54 | 0.25 | 0.14 | 0.13 | 0.50 | 0.28 | 0.25 | n/a | n/a | n/a |
| | 8 (203) | 0.67 | 0.60 | 0.59 | 0.76 | 0.56 | 0.54 | 0.58 | 0.55 | 0.55 | 0.30 | 0.17 | 0.16 | 0.61 | 0.34 | 0.31 | n/a | n/a | n/a |
| | 9 (229) | 0.69 | 0.61 | 0.60 | 0.82 | 0.59 | 0.57 | 0.58 | 0.56 | 0.55 | 0.36 | 0.20 | 0.19 | 0.72 | 0.41 | 0.37 | n/a | n/a | n/a |
| | 10 (254) | 0.71 | 0.62 | 0.61 | 0.88 | 0.62 | 0.60 | 0.59 | 0.56 | 0.56 | 0.42 | 0.24 | 0.22 | 0.85 | 0.48 | 0.43 | 0.61 | n/a | n/a |
| | 11 (279) | 0.73 | 0.63 | 0.62 | 0.95 | 0.65 | 0.62 | 0.60 | 0.57 | 0.57 | 0.49 | 0.27 | 0.25 | 0.95 | 0.55 | 0.50 | 0.64 | n/a | n/a |
| | 12 (305) | 0.75 | 0.64 | 0.63 | 1.00 | 0.69 | 0.65 | 0.61 | 0.58 | 0.57 | 0.56 | 0.31 | 0.29 | 1.00 | 0.63 | 0.57 | 0.67 | n/a | n/a |
| | 14 (356) | 0.80 | 0.67 | 0.65 | | 0.75 | 0.71 | 0.63 | 0.59 | 0.58 | 0.70 | 0.39 | 0.36 | | 0.75 | 0.71 | 0.73 | n/a | n/a |
| | 16 (406) | 0.84 | 0.69 | 0.67 | | 0.82 | 0.77 | 0.65 | 0.60 | 0.60 | 0.85 | 0.48 | 0.44 | | 0.82 | 0.77 | 0.77 | 0.64 | n/a |
| | 18 (457) | 0.88 | 0.71 | 0.70 | | 0.89 | 0.83 | 0.67 | 0.62 | 0.61 | 1.00 | 0.58 | 0.52 | | 0.89 | 0.83 | 0.82 | 0.68 | 0.66 |
| | 20 (508) | 0.92 | 0.74 | 0.72 | | 0.96 | 0.90 | 0.69 | 0.63 | 0.62 | | 0.67 | 0.61 | | 0.96 | 0.90 | 0.87 | 0.72 | 0.69 |
| | 22 (559) | 0.97 | 0.76 | 0.74 | | 1.00 | 0.96 | 0.71 | 0.64 | 0.63 | | 0.78 | 0.71 | | 1.00 | 0.96 | 0.91 | 0.75 | 0.73 |
| | 24 (610) | 1.00 | 0.79 | 0.76 | | | 1.00 | 0.73 | 0.65 | 0.64 | | 0.89 | 0.81 | | | 1.00 | 0.95 | 0.78 | 0.76 |
| | 26 (660) | | 0.81 | 0.78 | | | | 0.74 | 0.67 | 0.66 | | 1.00 | 0.91 | | | | 0.99 | 0.82 | 0.79 |
| | 28 (711) | | 0.83 | 0.80 | | | | 0.76 | 0.68 | 0.67 | | | 1.00 | | | | 1.00 | 0.85 | 0.82 |
| 30 (762) | | 0.86 | 0.83 | | | | 0.78 | 0.69 | 0.68 | | | | | | | | 0.88 | 0.85 | |
| 36 (914) | | 0.93 | 0.89 | | | | 0.84 | 0.73 | 0.72 | | | | | | | | 0.96 | 0.93 | |
| > 48 (1219) | | 1.00 | 1.00 | | | | 0.95 | 0.81 | 0.79 | | | | | | | | 1.00 | 1.00 | |

Table 49 – Load adjustment factors for 25M rebar in uncracked concrete ^{1,2,3}

| 25M Uncracked concrete | Spacing factor in tension f_{AN} | | | Edge distance factor in tension f_{RN} | | | Spacing factor in shear ⁴ f_{AV} | | | Edge distance in shear | | | | | | Concrete thickness factor in shear ⁵ f_{HV} | | | |
|---|---------------------------------------|-----------------|-------------------|---|-----------------|-------------------|--|-----------------|-------------------|------------------------------|-----------------|-------------------|--------------------------|-----------------|-------------------|---|-----------------|-------------------|-------------------|
| | | | | | | | | | | ⊥ Toward edge f_{RV} | | | ∥ To edge f_{RV} | | | | | | |
| | Embedment h_{ef} in (mm) | 9-1/16 (230) | 15-15/16 (405) | 19-13/16 (504) | 9-1/16 (230) | 15-15/16 (405) | 19-13/16 (504) | 9-1/16 (230) | 15-15/16 (405) | 19-13/16 (504) | 9-1/16 (230) | 15-15/16 (405) | 19-13/16 (504) | 9-1/16 (230) | 15-15/16 (405) | 19-13/16 (504) | 9-1/16 (230) | 15-15/16 (405) | 19-13/16 (504) |
| Spacing (s) / edge distance (c_a) / concrete thickness (h_c), - in (mm) | 1-3/4 (44) | n/a | n/a | n/a | 0.22 | 0.12 | 0.10 | n/a | n/a | n/a | 0.02 | 0.01 | 0.01 | 0.05 | 0.03 | 0.02 | n/a | n/a | n/a |
| | 5 (127) | 0.59 | 0.55 | 0.54 | 0.32 | 0.17 | 0.14 | 0.54 | 0.53 | 0.52 | 0.11 | 0.06 | 0.05 | 0.22 | 0.12 | 0.10 | n/a | n/a | n/a |
| | 6 (152) | 0.61 | 0.56 | 0.55 | 0.35 | 0.19 | 0.15 | 0.55 | 0.53 | 0.53 | 0.14 | 0.08 | 0.07 | 0.29 | 0.16 | 0.13 | n/a | n/a | n/a |
| | 7 (178) | 0.63 | 0.57 | 0.56 | 0.38 | 0.21 | 0.16 | 0.55 | 0.54 | 0.53 | 0.18 | 0.10 | 0.08 | 0.36 | 0.21 | 0.16 | n/a | n/a | n/a |
| | 8 (203) | 0.65 | 0.58 | 0.57 | 0.41 | 0.23 | 0.18 | 0.56 | 0.54 | 0.54 | 0.22 | 0.13 | 0.10 | 0.41 | 0.23 | 0.18 | n/a | n/a | n/a |
| | 9 (229) | 0.67 | 0.59 | 0.58 | 0.45 | 0.24 | 0.19 | 0.57 | 0.55 | 0.54 | 0.26 | 0.15 | 0.12 | 0.45 | 0.24 | 0.19 | n/a | n/a | n/a |
| | 10 (254) | 0.68 | 0.60 | 0.58 | 0.48 | 0.26 | 0.21 | 0.58 | 0.55 | 0.55 | 0.31 | 0.18 | 0.14 | 0.48 | 0.26 | 0.21 | n/a | n/a | n/a |
| | 11-9/16 (294) | 0.71 | 0.62 | 0.60 | 0.55 | 0.30 | 0.24 | 0.59 | 0.56 | 0.55 | 0.39 | 0.22 | 0.18 | 0.55 | 0.30 | 0.24 | 0.59 | n/a | n/a |
| | 12 (305) | 0.72 | 0.63 | 0.60 | 0.57 | 0.31 | 0.25 | 0.59 | 0.56 | 0.55 | 0.41 | 0.23 | 0.19 | 0.57 | 0.31 | 0.25 | 0.61 | n/a | n/a |
| | 14 (356) | 0.76 | 0.65 | 0.62 | 0.66 | 0.36 | 0.29 | 0.61 | 0.57 | 0.56 | 0.51 | 0.29 | 0.23 | 0.66 | 0.36 | 0.29 | 0.65 | n/a | n/a |
| | 16 (406) | 0.79 | 0.67 | 0.63 | 0.76 | 0.42 | 0.33 | 0.62 | 0.58 | 0.57 | 0.63 | 0.36 | 0.29 | 0.76 | 0.42 | 0.33 | 0.70 | n/a | n/a |
| | 18 (457) | 0.83 | 0.69 | 0.65 | 0.85 | 0.47 | 0.37 | 0.64 | 0.59 | 0.58 | 0.75 | 0.43 | 0.34 | 0.85 | 0.47 | 0.37 | 0.74 | n/a | n/a |
| | 18-7/16 (469) | 0.84 | 0.69 | 0.66 | 0.88 | 0.48 | 0.38 | 0.64 | 0.60 | 0.58 | 0.78 | 0.44 | 0.36 | 0.88 | 0.48 | 0.38 | 0.75 | 0.62 | n/a |
| | 20 (508) | 0.87 | 0.71 | 0.67 | 0.95 | 0.52 | 0.41 | 0.65 | 0.60 | 0.59 | 0.88 | 0.50 | 0.40 | 0.95 | 0.52 | 0.41 | 0.78 | 0.65 | n/a |
| | 22-3/8 (568) | 0.91 | 0.73 | 0.69 | 1.00 | 0.58 | 0.46 | 0.67 | 0.62 | 0.60 | 1.00 | 0.59 | 0.47 | 1.00 | 0.58 | 0.46 | 0.83 | 0.68 | 0.64 |
| | 24 (610) | 0.94 | 0.75 | 0.70 | | 0.62 | 0.50 | 0.68 | 0.63 | 0.61 | | 0.65 | 0.53 | | 0.62 | 0.50 | 0.86 | 0.71 | 0.66 |
| | 26 (660) | 0.98 | 0.77 | 0.72 | | 0.67 | 0.54 | 0.70 | 0.64 | 0.62 | | 0.74 | 0.59 | | 0.67 | 0.54 | 0.89 | 0.74 | 0.69 |
| | 28 (711) | 1.00 | 0.79 | 0.74 | | 0.73 | 0.58 | 0.71 | 0.65 | 0.63 | | 0.83 | 0.66 | | 0.73 | 0.58 | 0.92 | 0.77 | 0.71 |
| | 30 (762) | | 0.81 | 0.75 | | 0.78 | 0.62 | 0.73 | 0.66 | 0.64 | | 0.92 | 0.74 | | 0.78 | 0.62 | 0.96 | 0.79 | 0.74 |
| 36 (914) | | 0.88 | 0.80 | | 0.93 | 0.74 | 0.77 | 0.69 | 0.66 | | 1.00 | 0.97 | | 0.93 | 0.74 | 1.00 | 0.87 | 0.81 | |
| > 48 (1219) | | 1.00 | 0.90 | | 1.00 | 0.99 | 0.87 | 0.75 | 0.72 | | | 1.00 | | 1.00 | 0.99 | 1.00 | 1.00 | 0.93 | |

1 Linear interpolation not permitted

2 Shaded area with reduced edge distance is permitted provided the rebar has no installation torque.

3 When combining multiple load adjustment factors (e.g. for a four-anchor pattern in a corner with thin concrete member) the design can become very conservative. To optimize the design, use Hilti PROFIS Anchor Design software or perform anchor calculation using design equations from CSA A23.3-14 Annex D.

4 Spacing factor reduction in shear applicable when $c_a < 3 \cdot h_{ef}$, f_{AV} is applicable when edge distance, $c_a < 3 \cdot h_{ef}$. If $c_a \geq 3 \cdot h_{ef}$, then $f_{AV} = f_{AN}$.

5 Concrete thickness reduction factor in shear, f_{HV} is applicable when edge distance, $c_a < 3 \cdot h_{ef}$. If $c_a \geq 3 \cdot h_{ef}$, then $f_{HV} = 1.0$.



Table 50 – Load adjustment factors for 25M rebar in cracked concrete ^{1,2,3}

| 25M Cracked concrete | Spacing factor in tension | | | Edge distance factor in tension | | | Spacing factor in shear ⁴ | | | Edge distance in shear | | | | | | Concrete thickness factor in shear ⁵ | | | |
|--|-------------------------------|-----------------|-------------------|---------------------------------|-----------------|-------------------|--------------------------------------|-----------------|-------------------|------------------------------|-----------------|-------------------|--------------------------|-----------------|-------------------|---|-----------------|-------------------|-------------------|
| | f_{AN} | | | f_{RN} | | | f_{AV} | | | ⊥ Toward edge f_{RV} | | | ∥ To edge f_{RV} | | | f_{HV} | | | |
| | Embedment h_{ef} in (mm) | 9-1/16 (230) | 15-15/16 (405) | 19-13/16 (504) | 9-1/16 (230) | 15-15/16 (405) | 19-13/16 (504) | 9-1/16 (230) | 15-15/16 (405) | 19-13/16 (504) | 9-1/16 (230) | 15-15/16 (405) | 19-13/16 (504) | 9-1/16 (230) | 15-15/16 (405) | 19-13/16 (504) | 9-1/16 (230) | 15-15/16 (405) | 19-13/16 (504) |
| Spacing (s) / edge distance (c_e) / concrete thickness (h_c) - in (mm) | 1-3/4 (44) | n/a | n/a | n/a | 0.42 | 0.39 | 0.38 | n/a | n/a | n/a | 0.02 | 0.01 | 0.01 | 0.05 | 0.03 | 0.02 | n/a | n/a | n/a |
| | 5 (127) | 0.59 | 0.55 | 0.54 | 0.55 | 0.46 | 0.44 | 0.54 | 0.53 | 0.52 | 0.12 | 0.07 | 0.05 | 0.24 | 0.14 | 0.11 | n/a | n/a | n/a |
| | 6 (152) | 0.61 | 0.56 | 0.55 | 0.60 | 0.48 | 0.46 | 0.55 | 0.53 | 0.53 | 0.16 | 0.09 | 0.07 | 0.31 | 0.18 | 0.14 | n/a | n/a | n/a |
| | 7 (178) | 0.63 | 0.57 | 0.56 | 0.65 | 0.51 | 0.48 | 0.56 | 0.54 | 0.53 | 0.20 | 0.11 | 0.09 | 0.40 | 0.22 | 0.18 | n/a | n/a | n/a |
| | 8 (203) | 0.65 | 0.58 | 0.57 | 0.70 | 0.53 | 0.50 | 0.56 | 0.54 | 0.54 | 0.24 | 0.14 | 0.11 | 0.48 | 0.27 | 0.22 | n/a | n/a | n/a |
| | 9 (229) | 0.67 | 0.59 | 0.58 | 0.75 | 0.56 | 0.51 | 0.57 | 0.55 | 0.54 | 0.29 | 0.16 | 0.13 | 0.58 | 0.33 | 0.26 | n/a | n/a | n/a |
| | 10 (254) | 0.68 | 0.60 | 0.58 | 0.80 | 0.59 | 0.53 | 0.58 | 0.56 | 0.55 | 0.34 | 0.19 | 0.15 | 0.68 | 0.38 | 0.31 | n/a | n/a | n/a |
| | 11-9/16 (294) | 0.71 | 0.62 | 0.60 | 0.89 | 0.63 | 0.57 | 0.59 | 0.56 | 0.56 | 0.42 | 0.24 | 0.19 | 0.84 | 0.48 | 0.38 | 0.61 | n/a | n/a |
| | 12 (305) | 0.72 | 0.63 | 0.60 | 0.91 | 0.64 | 0.58 | 0.60 | 0.57 | 0.56 | 0.44 | 0.25 | 0.20 | 0.89 | 0.50 | 0.41 | 0.62 | n/a | n/a |
| | 14 (356) | 0.76 | 0.65 | 0.62 | 1.00 | 0.69 | 0.62 | 0.61 | 0.58 | 0.57 | 0.56 | 0.32 | 0.26 | 1.00 | 0.64 | 0.51 | 0.67 | n/a | n/a |
| | 16 (406) | 0.79 | 0.67 | 0.63 | | 0.75 | 0.66 | 0.63 | 0.59 | 0.58 | 0.68 | 0.39 | 0.31 | | 0.75 | 0.62 | 0.72 | n/a | n/a |
| | 18 (457) | 0.83 | 0.69 | 0.65 | | 0.81 | 0.71 | 0.65 | 0.60 | 0.59 | 0.82 | 0.46 | 0.37 | | 0.81 | 0.71 | 0.76 | n/a | n/a |
| | 18-7/16 (469) | 0.84 | 0.69 | 0.66 | | 0.83 | 0.72 | 0.65 | 0.60 | 0.59 | 0.85 | 0.48 | 0.39 | | 0.83 | 0.72 | 0.77 | 0.64 | n/a |
| | 20 (508) | 0.87 | 0.71 | 0.67 | | 0.87 | 0.75 | 0.66 | 0.61 | 0.60 | 0.96 | 0.54 | 0.44 | | 0.87 | 0.75 | 0.80 | 0.67 | n/a |
| | 22-3/8 (568) | 0.91 | 0.73 | 0.69 | | 0.95 | 0.81 | 0.68 | 0.62 | 0.61 | 1.00 | 0.64 | 0.52 | | 0.95 | 0.81 | 0.85 | 0.70 | 0.65 |
| | 24 (610) | 0.94 | 0.75 | 0.70 | | 1.00 | 0.85 | 0.69 | 0.63 | 0.62 | | 0.71 | 0.57 | | 1.00 | 0.85 | 0.88 | 0.73 | 0.68 |
| | 26 (660) | 0.98 | 0.77 | 0.72 | | | 0.90 | 0.71 | 0.64 | 0.62 | | 0.80 | 0.65 | | | 0.90 | 0.92 | 0.76 | 0.71 |
| | 28 (711) | 1.00 | 0.79 | 0.74 | | | 0.95 | 0.73 | 0.66 | 0.63 | | 0.90 | 0.72 | | | 0.95 | 0.95 | 0.79 | 0.73 |
| | 30 (762) | | 0.81 | 0.75 | | | 1.00 | 0.74 | 0.67 | 0.64 | | 1.00 | 0.80 | | | 1.00 | 0.99 | 0.82 | 0.76 |
| 36 (914) | | 0.88 | 0.80 | | | | 0.79 | 0.70 | 0.67 | | | 1.00 | | | | 1.00 | 0.89 | 0.83 | |
| > 48 (1219) | | 1.00 | 0.90 | | | | 0.89 | 0.77 | 0.73 | | | | | | | | 1.00 | 0.96 | |

Table 51 – Load adjustment factors for 30M rebar in uncracked concrete ^{1,2,3}

| 30M Uncracked concrete | Spacing factor in tension | | | Edge distance factor in tension | | | Spacing factor in shear ⁴ | | | Edge distance in shear | | | | | | Concrete thickness factor in shear ⁵ | | | |
|--|-------------------------------|-----------------|-------------------|---------------------------------|-----------------|-------------------|--------------------------------------|-----------------|-------------------|------------------------------|-----------------|-------------------|--------------------------|-----------------|-------------------|---|-----------------|-------------------|------------------|
| | f_{AN} | | | f_{RN} | | | f_{AV} | | | ⊥ Toward edge f_{RV} | | | ∥ To edge f_{RV} | | | f_{HV} | | | |
| | Embedment h_{ef} in (mm) | 10-1/4 (260) | 17-15/16 (455) | 23-9/16 (598) | 10-1/4 (260) | 17-15/16 (455) | 23-9/16 (598) | 10-1/4 (260) | 17-15/16 (455) | 23-9/16 (598) | 10-1/4 (260) | 17-15/16 (455) | 23-9/16 (598) | 10-1/4 (260) | 17-15/16 (455) | 23-9/16 (598) | 10-1/4 (260) | 17-15/16 (455) | 23-9/16 (598) |
| Spacing (s) / edge distance (c_e) / concrete thickness (h_c) - in (mm) | 1-3/4 (44) | n/a | n/a | n/a | 0.23 | 0.13 | 0.09 | n/a | n/a | n/a | 0.02 | 0.01 | 0.01 | 0.04 | 0.03 | 0.02 | n/a | n/a | n/a |
| | 5-7/8 (150) | 0.60 | 0.55 | 0.54 | 0.34 | 0.19 | 0.14 | 0.54 | 0.53 | 0.53 | 0.14 | 0.08 | 0.06 | 0.28 | 0.16 | 0.12 | n/a | n/a | n/a |
| | 6 (152) | 0.60 | 0.56 | 0.54 | 0.34 | 0.19 | 0.14 | 0.55 | 0.53 | 0.53 | 0.14 | 0.08 | 0.06 | 0.28 | 0.16 | 0.12 | n/a | n/a | n/a |
| | 7 (178) | 0.61 | 0.57 | 0.55 | 0.37 | 0.20 | 0.15 | 0.55 | 0.54 | 0.53 | 0.18 | 0.10 | 0.08 | 0.36 | 0.20 | 0.15 | n/a | n/a | n/a |
| | 8 (203) | 0.63 | 0.57 | 0.56 | 0.40 | 0.22 | 0.16 | 0.56 | 0.54 | 0.53 | 0.22 | 0.12 | 0.09 | 0.40 | 0.22 | 0.16 | n/a | n/a | n/a |
| | 9 (229) | 0.65 | 0.58 | 0.56 | 0.43 | 0.24 | 0.18 | 0.57 | 0.55 | 0.54 | 0.26 | 0.15 | 0.11 | 0.43 | 0.24 | 0.18 | n/a | n/a | n/a |
| | 10 (254) | 0.66 | 0.59 | 0.57 | 0.46 | 0.25 | 0.19 | 0.58 | 0.55 | 0.54 | 0.30 | 0.17 | 0.13 | 0.46 | 0.25 | 0.19 | n/a | n/a | n/a |
| | 11 (279) | 0.68 | 0.60 | 0.58 | 0.50 | 0.27 | 0.20 | 0.58 | 0.56 | 0.55 | 0.35 | 0.20 | 0.15 | 0.50 | 0.27 | 0.20 | n/a | n/a | n/a |
| | 12 (305) | 0.70 | 0.61 | 0.58 | 0.53 | 0.29 | 0.22 | 0.59 | 0.56 | 0.55 | 0.40 | 0.23 | 0.17 | 0.53 | 0.29 | 0.22 | n/a | n/a | n/a |
| | 13-1/4 (337) | 0.72 | 0.62 | 0.59 | 0.58 | 0.32 | 0.24 | 0.60 | 0.57 | 0.56 | 0.46 | 0.26 | 0.20 | 0.58 | 0.32 | 0.24 | 0.63 | n/a | n/a |
| | 14 (356) | 0.73 | 0.63 | 0.60 | 0.62 | 0.34 | 0.25 | 0.61 | 0.57 | 0.56 | 0.50 | 0.29 | 0.22 | 0.62 | 0.34 | 0.25 | 0.65 | n/a | n/a |
| | 16 (406) | 0.76 | 0.65 | 0.61 | 0.70 | 0.39 | 0.29 | 0.62 | 0.58 | 0.57 | 0.61 | 0.35 | 0.27 | 0.70 | 0.39 | 0.29 | 0.69 | n/a | n/a |
| | 18 (457) | 0.79 | 0.67 | 0.63 | 0.79 | 0.44 | 0.33 | 0.64 | 0.59 | 0.58 | 0.73 | 0.42 | 0.32 | 0.79 | 0.44 | 0.33 | 0.74 | n/a | n/a |
| | 20 (508) | 0.83 | 0.69 | 0.64 | 0.88 | 0.48 | 0.36 | 0.65 | 0.60 | 0.59 | 0.86 | 0.49 | 0.37 | 0.88 | 0.48 | 0.36 | 0.78 | n/a | n/a |
| | 20-7/8 (531) | 0.84 | 0.69 | 0.65 | 0.92 | 0.51 | 0.38 | 0.66 | 0.61 | 0.59 | 0.92 | 0.52 | 0.40 | 0.92 | 0.51 | 0.38 | 0.79 | n/a | n/a |
| | 22 (559) | 0.86 | 0.70 | 0.66 | 0.97 | 0.53 | 0.40 | 0.67 | 0.61 | 0.59 | 0.99 | 0.57 | 0.43 | 0.97 | 0.53 | 0.40 | 0.81 | 0.68 | n/a |
| | 24 (610) | 0.89 | 0.72 | 0.67 | 1.00 | 0.58 | 0.44 | 0.68 | 0.62 | 0.60 | 1.00 | 0.64 | 0.49 | 1.00 | 0.58 | 0.44 | 0.85 | 0.71 | n/a |
| | 26-9/16 (675) | 0.93 | 0.75 | 0.69 | | 0.64 | 0.48 | 0.70 | 0.64 | 0.61 | | 0.75 | 0.57 | | 0.64 | 0.48 | 0.89 | 0.74 | 0.68 |
| | 28 (711) | 0.96 | 0.76 | 0.70 | | 0.68 | 0.51 | 0.71 | 0.65 | 0.62 | | 0.81 | 0.62 | | 0.68 | 0.51 | 0.92 | 0.76 | 0.70 |
| | 30 (762) | 0.99 | 0.78 | 0.71 | | 0.73 | 0.55 | 0.73 | 0.66 | 0.63 | | 0.90 | 0.68 | | 0.73 | 0.55 | 0.95 | 0.79 | 0.72 |
| 36 (914) | 1.00 | 0.83 | 0.75 | | 0.87 | 0.65 | 0.77 | 0.69 | 0.66 | | 1.00 | 0.90 | | 0.87 | 0.65 | 1.00 | 0.86 | 0.79 | |
| > 48 (1219) | | 0.95 | 0.84 | | 1.00 | 0.87 | 0.86 | 0.75 | 0.71 | | 1.00 | 1.00 | | 1.00 | 0.87 | 1.00 | 1.00 | 0.91 | |

1 Linear interpolation not permitted

2 Shaded area with reduced edge distance is permitted provided the rebar has no installation torque.

3 When combining multiple load adjustment factors (e.g. for a four-anchor pattern in a corner with thin concrete member) the design can become very conservative. To optimize the design, use Hilti PROFIS Anchor Design software or perform anchor calculation using design equations from CSA A23.3-14 Annex D.

4 Spacing factor reduction in shear applicable when $c_e < 3 \cdot h_{ef}$, f_{AV} is applicable when edge distance, $c_e < 3 \cdot h_{ef}$. If $c_e \geq 3 \cdot h_{ef}$, then $f_{AV} = f_{AN}$.

5 Concrete thickness reduction factor in shear, f_{HV} is applicable when edge distance, $c_e < 3 \cdot h_{ef}$. If $c_e \geq 3 \cdot h_{ef}$, then $f_{HV} = 1.0$.



Table 52 – Load adjustment factors for 30M rebar in cracked concrete ^{1,2,3}

| 30M Cracked concrete | Spacing factor in tension | | | Edge distance factor in tension | | | Spacing factor in shear ⁴ | | | Edge distance in shear | | | | | | Concrete thickness factor in shear ⁵ | | | |
|---|-------------------------------|-----------------|-------------------|------------------------------------|-----------------|-------------------|---|-----------------|-------------------|------------------------------|-----------------|-------------------|--------------------------|-----------------|-------------------|--|-----------------|-------------------|------------------|
| | f_{AN} | | | f_{RN} | | | f_{AV} | | | ⊥ Toward edge f_{RV} | | | ∥ To edge f_{RV} | | | f_{HV} | | | |
| | Embedment h_{ef} in (mm) | 10-1/4 (260) | 17-15/16 (455) | 23-9/16 (598) | 10-1/4 (260) | 17-15/16 (455) | 23-9/16 (598) | 10-1/4 (260) | 17-15/16 (455) | 23-9/16 (598) | 10-1/4 (260) | 17-15/16 (455) | 23-9/16 (598) | 10-1/4 (260) | 17-15/16 (455) | 23-9/16 (598) | 10-1/4 (260) | 17-15/16 (455) | 23-9/16 (598) |
| Spacing (s) / edge distance (c_a) / concrete thickness (h), - in (mm) | 1-3/4 (44) | n/a | n/a | n/a | 0.41 | 0.38 | 0.38 | n/a | n/a | n/a | 0.02 | 0.01 | 0.01 | 0.04 | 0.02 | 0.02 | n/a | n/a | n/a |
| | 5-7/8 (150) | 0.60 | 0.55 | 0.54 | 0.56 | 0.47 | 0.44 | 0.54 | 0.53 | 0.53 | 0.13 | 0.08 | 0.06 | 0.27 | 0.15 | 0.12 | n/a | n/a | n/a |
| | 6 (152) | 0.60 | 0.56 | 0.54 | 0.57 | 0.47 | 0.44 | 0.54 | 0.53 | 0.53 | 0.14 | 0.08 | 0.06 | 0.28 | 0.16 | 0.12 | n/a | n/a | n/a |
| | 7 (178) | 0.61 | 0.57 | 0.55 | 0.61 | 0.49 | 0.46 | 0.55 | 0.54 | 0.53 | 0.17 | 0.10 | 0.08 | 0.35 | 0.20 | 0.15 | n/a | n/a | n/a |
| | 8 (203) | 0.63 | 0.57 | 0.56 | 0.65 | 0.51 | 0.47 | 0.56 | 0.54 | 0.53 | 0.21 | 0.12 | 0.09 | 0.42 | 0.24 | 0.18 | n/a | n/a | n/a |
| | 9 (229) | 0.65 | 0.58 | 0.56 | 0.69 | 0.53 | 0.49 | 0.57 | 0.55 | 0.54 | 0.25 | 0.14 | 0.11 | 0.51 | 0.29 | 0.22 | n/a | n/a | n/a |
| | 10 (254) | 0.66 | 0.59 | 0.57 | 0.74 | 0.56 | 0.50 | 0.57 | 0.55 | 0.54 | 0.30 | 0.17 | 0.13 | 0.59 | 0.34 | 0.26 | n/a | n/a | n/a |
| | 11 (279) | 0.68 | 0.60 | 0.58 | 0.79 | 0.58 | 0.52 | 0.58 | 0.56 | 0.55 | 0.34 | 0.20 | 0.15 | 0.68 | 0.39 | 0.30 | n/a | n/a | n/a |
| | 12 (305) | 0.70 | 0.61 | 0.58 | 0.83 | 0.60 | 0.54 | 0.59 | 0.56 | 0.55 | 0.39 | 0.22 | 0.17 | 0.78 | 0.45 | 0.34 | n/a | n/a | n/a |
| | 13-1/4 (337) | 0.72 | 0.62 | 0.59 | 0.89 | 0.63 | 0.56 | 0.60 | 0.57 | 0.56 | 0.45 | 0.26 | 0.20 | 0.89 | 0.52 | 0.39 | 0.63 | n/a | n/a |
| | 14 (356) | 0.73 | 0.63 | 0.60 | 0.93 | 0.65 | 0.57 | 0.60 | 0.57 | 0.56 | 0.49 | 0.28 | 0.21 | 0.93 | 0.56 | 0.43 | 0.64 | n/a | n/a |
| | 16 (406) | 0.76 | 0.65 | 0.61 | 1.00 | 0.70 | 0.61 | 0.62 | 0.58 | 0.57 | 0.60 | 0.34 | 0.26 | 1.00 | 0.69 | 0.52 | 0.69 | n/a | n/a |
| | 18 (457) | 0.79 | 0.67 | 0.63 | | 0.75 | 0.64 | 0.63 | 0.59 | 0.58 | 0.72 | 0.41 | 0.31 | | 0.75 | 0.62 | 0.73 | n/a | n/a |
| | 20 (508) | 0.83 | 0.69 | 0.64 | | 0.81 | 0.68 | 0.65 | 0.60 | 0.59 | 0.84 | 0.48 | 0.36 | | 0.81 | 0.68 | 0.77 | n/a | n/a |
| | 20-7/8 (531) | 0.84 | 0.69 | 0.65 | | 0.83 | 0.70 | 0.65 | 0.61 | 0.59 | 0.90 | 0.51 | 0.39 | | 0.83 | 0.70 | 0.79 | n/a | n/a |
| | 22 (559) | 0.86 | 0.70 | 0.66 | | 0.86 | 0.72 | 0.66 | 0.61 | 0.59 | 0.97 | 0.55 | 0.42 | | 0.86 | 0.72 | 0.81 | 0.67 | n/a |
| | 24 (610) | 0.89 | 0.72 | 0.67 | | 0.92 | 0.76 | 0.68 | 0.62 | 0.60 | 1.00 | 0.63 | 0.48 | | 0.92 | 0.76 | 0.84 | 0.70 | n/a |
| | 26-9/16 (675) | 0.93 | 0.75 | 0.69 | | 0.99 | 0.81 | 0.70 | 0.64 | 0.61 | | 0.73 | 0.56 | | 0.99 | 0.81 | 0.89 | 0.74 | 0.67 |
| 28 (711) | 0.96 | 0.76 | 0.70 | | 1.00 | 0.84 | 0.71 | 0.64 | 0.62 | | 0.79 | 0.60 | | 1.00 | 0.84 | 0.91 | 0.76 | 0.69 | |
| 30 (762) | 0.99 | 0.78 | 0.71 | | | 0.88 | 0.72 | 0.65 | 0.63 | | 0.88 | 0.67 | | 1.00 | 0.88 | 0.94 | 0.78 | 0.71 | |
| 36 (914) | 1.00 | 0.83 | 0.75 | | | 1.00 | 0.77 | 0.68 | 0.65 | | 1.00 | 0.88 | | | 1.00 | 1.00 | 0.86 | 0.78 | |
| > 48 (1219) | | 0.95 | 0.84 | | | | 0.86 | 0.74 | 0.70 | | | 1.00 | | | | | 0.99 | 0.90 | |

1 Linear interpolation not permitted

2 Shaded area with reduced edge distance is permitted provided the rebar has no installation torque.

3 When combining multiple load adjustment factors (e.g. for a four-anchor pattern in a corner with thin concrete member) the design can become very conservative. To optimize the design, use Hilti PROFIS Anchor Design software or perform anchor calculation using design equations from CSA A23.3-14 Annex D.

4 Spacing factor reduction in shear applicable when $c_a < 3 \cdot h_{ef}$. f_{AV} is applicable when edge distance, $c_a < 3 \cdot h_{ef}$. If $c_a \geq 3 \cdot h_{ef}$, then $f_{AV} = f_{AN}$.

5 Concrete thickness reduction factor in shear, f_{HV} , is applicable when edge distance, $c_a < 3 \cdot h_{ef}$. If $c_a \geq 3 \cdot h_{ef}$, then $f_{HV} = 1.0$.

Hilti HIT-HY 100 adhesive with Hilti HAS threaded rod

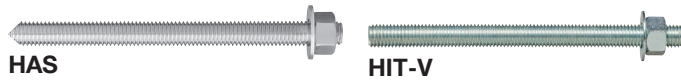

Table 53 — Hilti HIT-HY 100 design information with HAS/HIT-V threaded rods in hammer drilled holes in accordance with CSA A23.3-14 Annex D ¹



| Design parameter | Symbol | Units | Nominal rod diameter (in.) | | | | | | | Ref A23.3-14 | |
|--|---|-------------------|------------------------------|-----------------|-----------------|-----------------|-----------------|----------------|----------------|-----------------|-----------|
| | | | 3/8 | 1/2 | 5/8 | 3/4 | 7/8 | 1 | 1-1/4 | | |
| Anchor O.D. | d_0 | mm | 9.5 | 12.7 | 15.9 | 19.1 | 22.2 | 25.4 | 31.8 | | |
| Effective minimum embedment ² | $h_{ef,min}$ | mm | 60 | 70 | 79 | 89 | 89 | 102 | 127 | | |
| Effective maximum embedment ² | $h_{ef,max}$ | mm | 191 | 254 | 318 | 381 | 445 | 508 | 635 | | |
| Min. concrete thickness ² | h_{min} | mm | $h_{ef} + 30$ | | | $h_{ef} + 2d_0$ | | | | | |
| Critical edge distance | c_{ac} | - | See ESR-3187, section 4.1.10 | | | | | | | | |
| Minimum edge distance | c_{min}^3 | mm | 48 | 64 | 79 | 95 | 111 | 127 | 159 | | |
| Minimum anchor spacing | s_{min} | mm | 48 | 64 | 79 | 95 | 111 | 127 | 159 | | |
| Coeff. for factored conc. breakout resistance, uncracked concrete | $k_{c,un-cr}^4$ | - | 10 | | | | | | | D.6.2.2 | |
| Coeff. for factored conc. breakout resistance, cracked concrete | $k_{c,cr}^4$ | - | 7 | | | | | | | D.6.2.2 | |
| Concrete material resistance factor | ϕ_c | - | 0.65 | | | | | | | 8.4.2 | |
| Resistance modification factor for tension and shear, concrete failure modes, Condition B ⁵ | R_{conc} | - | 1.00 | | | | | | | D.5.3 (c) | |
| Temp. range A ⁶ | Characteristic bond stress in cracked concrete ⁷ | T_{cr} | psi (MPa) | 615 (4.2) | 670 (4.6) | 725 (5.0) | 775 (5.3) | 780 (5.4) | 790 (5.4) | - - | D.6.5.2 |
| | Characteristic bond stress in uncracked concrete ⁷ | T_{un-cr} | psi (MPa) | 1,490 (10.3) | 1,490 (10.3) | 1,490 (10.3) | 1,490 (10.3) | 1,390 (9.6) | 1,270 (8.9) | 1,030 (7.1) | D.6.5.2 |
| Temp. range B ⁶ | Characteristic bond stress in cracked concrete ⁷ | T_{cr} | psi (MPa) | 565 (3.9) | 620 (4.3) | 665 (4.6) | 715 (4.9) | 720 (5.0) | 725 (5.0) | - - | D.6.5.2 |
| | Characteristic bond stress in uncracked concrete ⁷ | T_{un-cr} | psi (MPa) | 1,450 (10.0) | 1,450 (10.0) | 1,450 (10.0) | 1,385 (9.6) | 1,275 (8.8) | 1,170 (8.1) | 950 (6.6) | D.6.5.2 |
| Temp. range C ⁶ | Characteristic bond stress in cracked concrete ⁷ | T_{cr} | psi (MPa) | 440 (3.0) | 480 (3.3) | 520 (3.5) | 555 (3.8) | 560 (3.9) | 565 (3.9) | - - | D.6.5.2 |
| | Characteristic bond stress in uncracked concrete ⁷ | T_{un-cr} | psi (MPa) | 1,250 (8.6) | 1,250 (8.6) | 1,165 (8.0) | 1,080 (7.4) | 995 (6.9) | 910 (6.3) | 740 (5.1) | D.6.5.2 |
| Reduction for seismic tension | | $\alpha_{N,seis}$ | - | 1.00 | | | | | | | |
| Permissible installation conditions | Resistance modification factor tension & shear, bond failure dry concrete | Anchor category | - | 1 | | | | | 2 | | D.5.3 (c) |
| | | R_{dry} | - | 1.00 | | | | | 0.85 | | |
| | Resistance modification factor tension & shear, bond failure water-saturated concrete | Anchor category | - | 2 | | | | | | | D.5.3 (c) |
| | | R_{ws} | - | 0.85 | | | | | | | |

1 Design information in this table is taken from ICC-ES ESR-3574, dated March, 2018, table 8 and 9, and converted for use with CSA A23.3-14 Annex D.
 2 See figure at the beginning of the threaded rod section.
 3 Minimum edge distance may be reduced to $45\text{mm} \leq c_{at} < 5d$ provided τ_{inst} is reduced. See ESR-3187 section 4.1.9.2.
 4 For all design cases, $\psi_{c,N} = 1.0$. The appropriate coefficient for breakout resistance for cracked concrete ($k_{c,cr}$) or uncracked concrete ($k_{c,un-cr}$) must be used.
 5 For use with the load combinations of CSA A23.3-14 chapter 8. Condition B applies where supplementary reinforcement in conformance with CSA A23.3-14 section D.5.3 is not provided, or where pullout or pryout strength governs. For cases where the presence of supplementary reinforcement can be verified, the resistance modification factors associated with Condition A may be used.
 6 Temperature range A: Max. short term temperature = 130°F (55°C), max. long term temperature = 110°F (43°C).
 Temperature range B: Max. short term temperature = 176°F (80°C), max. long term temperature = 110°F (43°C).
 Temperature range C: Max. short term temperature = 210°F (99°C), max. long term temperature = 162°F (72°C).
 Short term elevated concrete temperatures are those that occur over brief intervals, e.g., as a result of diurnal cycling. Long term concrete temperatures are roughly constant over significant periods of time.
 7 Bond strength values corresponding to concrete compressive strength $f'_c = 2,500$ psi (17.2 MPa). For concrete compressive strength, f'_c , between 2,500 psi (17.2 MPa) and 8,000 psi (55.2 MPa), the tabulated characteristic bond strength may be increased by a factor of $(f'_c/2,500)^{0.1}$ [for SI: $(f'_c/17.2)^{0.1}$].

Table 54 — Hilti HIT-HY 100 adhesive factored resistance with concrete / bond failure for threaded rod in uncracked concrete 1,2,3,4,5,6,7,8



| Nominal anchor diameter in. | Effective embedment in. (mm) | Tension — N_t | | | | Shear — V_r | | | |
|-----------------------------|------------------------------|---|---|---|---|---|---|---|---|
| | | $f'_c = 20$ MPa (2,900 psi) lb (kN) | $f'_c = 25$ MPa (3,625 psi) lb (kN) | $f'_c = 30$ MPa (4,350 psi) lb (kN) | $f'_c = 40$ MPa (5,800 psi) lb (kN) | $f'_c = 20$ MPa (2,900 psi) lb (kN) | $f'_c = 25$ MPa (3,625 psi) lb (kN) | $f'_c = 30$ MPa (4,350 psi) lb (kN) | $f'_c = 40$ MPa (5,800 psi) lb (kN) |
| 3/8 | 2-3/8 (60) | 1,165 (5.2) | 1,190 (5.3) | 1,210 (5.4) | 1,245 (5.5) | 1,165 (5.2) | 1,190 (5.3) | 1,210 (5.4) | 1,245 (5.5) |
| | 3-3/8 (86) | 1,655 (7.4) | 1,690 (7.5) | 1,720 (7.7) | 1,770 (7.9) | 3,305 (14.7) | 3,380 (15.0) | 3,445 (15.3) | 3,545 (15.8) |
| | 4-1/2 (114) | 2,205 (9.8) | 2,255 (10.0) | 2,295 (10.2) | 2,365 (10.5) | 4,410 (19.6) | 4,510 (20.1) | 4,590 (20.4) | 4,725 (21.0) |
| | 7-1/2 (191) | 3,675 (16.3) | 3,755 (16.7) | 3,825 (17.0) | 3,940 (17.5) | 7,350 (32.7) | 7,515 (33.4) | 7,650 (34.0) | 7,875 (35.0) |
| 1/2 | 2-3/4 (70) | 1,910 (8.5) | 1,955 (8.7) | 1,990 (8.8) | 2,045 (9.1) | 3,820 (17.0) | 3,905 (17.4) | 3,980 (17.7) | 4,095 (18.2) |
| | 4-1/2 (114) | 3,125 (13.9) | 3,195 (14.2) | 3,255 (14.5) | 3,350 (14.9) | 6,250 (27.8) | 6,395 (28.4) | 6,510 (29.0) | 6,700 (29.8) |
| | 6 (152) | 4,170 (18.5) | 4,260 (19.0) | 4,340 (19.3) | 4,465 (19.9) | 8,335 (37.1) | 8,525 (37.9) | 8,680 (38.6) | 8,935 (39.7) |
| | 10 (254) | 6,945 (30.9) | 7,105 (31.6) | 7,235 (32.2) | 7,445 (33.1) | 13,895 (61.8) | 14,205 (63.2) | 14,470 (64.4) | 14,890 (66.2) |
| 5/8 | 3-1/8 (79) | 2,935 (13.1) | 3,005 (13.4) | 3,060 (13.6) | 3,145 (14.0) | 5,875 (26.1) | 6,005 (26.7) | 6,115 (27.2) | 6,295 (28.0) |
| | 5-5/8 (143) | 5,285 (23.5) | 5,405 (24.0) | 5,505 (24.5) | 5,665 (25.2) | 10,570 (47.0) | 10,810 (48.1) | 11,010 (49.0) | 11,330 (50.4) |
| | 7-1/2 (191) | 7,045 (31.3) | 7,205 (32.1) | 7,340 (32.6) | 7,555 (33.6) | 14,095 (62.7) | 14,410 (64.1) | 14,675 (65.3) | 15,105 (67.2) |
| | 12-1/2 (318) | 11,745 (52.2) | 12,010 (53.4) | 12,230 (54.4) | 12,590 (56.0) | 23,490 (104.5) | 24,020 (106.8) | 24,460 (108.8) | 25,175 (112.0) |
| 3/4 | 3-1/2 (89) | 5,480 (24.4) | 6,125 (27.2) | 6,710 (29.8) | 7,745 (34.5) | 10,955 (48.7) | 12,250 (54.5) | 13,420 (59.7) | 15,495 (68.9) |
| | 6-3/4 (171) | 14,670 (65.3) | 15,995 (71.1) | 16,290 (72.5) | 16,765 (74.6) | 29,340 (130.5) | 31,990 (142.3) | 32,580 (144.9) | 33,530 (149.1) |
| | 9 (229) | 20,855 (92.8) | 21,325 (94.9) | 21,720 (96.6) | 22,350 (99.4) | 41,710 (185.5) | 42,650 (189.7) | 43,435 (193.2) | 44,705 (198.9) |
| | 15 (381) | 34,760 (154.6) | 35,545 (158.1) | 36,195 (161.0) | 37,255 (165.7) | 69,520 (309.2) | 71,085 (316.2) | 72,395 (322.0) | 74,510 (331.4) |
| 7/8 | 3-1/2 (89) | 5,480 (24.4) | 6,125 (27.2) | 6,710 (29.8) | 7,745 (34.5) | 10,955 (48.7) | 12,250 (54.5) | 13,420 (59.7) | 15,495 (68.9) |
| | 7-7/8 (200) | 18,485 (82.2) | 20,310 (90.3) | 20,685 (92.0) | 21,285 (94.7) | 36,975 (164.5) | 40,620 (180.7) | 41,365 (184.0) | 42,575 (189.4) |
| | 10-1/2 (267) | 26,480 (117.8) | 27,080 (120.5) | 27,575 (122.7) | 28,380 (126.2) | 52,965 (235.6) | 54,160 (240.9) | 55,155 (245.3) | 56,765 (252.5) |
| | 17-1/2 (445) | 44,135 (196.3) | 45,130 (200.8) | 45,960 (204.4) | 47,305 (210.4) | 88,270 (392.6) | 90,265 (401.5) | 91,925 (408.9) | 94,605 (420.8) |
| 1 | 4 (102) | 6,690 (29.8) | 7,480 (33.3) | 8,195 (36.5) | 9,465 (42.1) | 13,385 (59.5) | 14,965 (66.6) | 16,395 (72.9) | 18,930 (84.2) |
| | 9 (229) | 22,585 (100.5) | 24,235 (107.8) | 24,680 (109.8) | 25,405 (113.0) | 45,175 (200.9) | 48,475 (215.6) | 49,365 (219.6) | 50,805 (226.0) |
| | 12 (305) | 31,600 (140.6) | 32,315 (143.7) | 32,910 (146.4) | 33,870 (150.7) | 63,205 (281.1) | 64,630 (287.5) | 65,820 (292.8) | 67,740 (301.3) |
| | 20 (508) | 52,670 (234.3) | 53,860 (239.6) | 54,850 (244.0) | 56,450 (251.1) | 105,340 (468.6) | 107,715 (479.1) | 109,700 (488.0) | 112,900 (502.2) |
| 1-1/4 | 5 (127) | 9,355 (41.6) | 10,455 (46.5) | 11,455 (51.0) | 13,225 (58.8) | 18,705 (83.2) | 20,915 (93.0) | 22,910 (101.9) | 26,455 (117.7) |
| | 11-1/4 (286) | 30,035 (133.6) | 30,715 (136.6) | 31,280 (139.1) | 32,190 (143.2) | 60,070 (267.2) | 61,425 (273.2) | 62,555 (278.3) | 64,380 (286.4) |
| | 15 (381) | 40,045 (178.1) | 40,950 (182.2) | 41,705 (185.5) | 42,920 (190.9) | 80,095 (356.3) | 81,900 (364.3) | 83,410 (371.0) | 85,840 (381.8) |
| | 25 (635) | 66,745 (296.9) | 68,250 (303.6) | 69,505 (309.2) | 71,535 (318.2) | 133,490 (593.8) | 136,500 (607.2) | 139,015 (618.4) | 143,070 (636.4) |

- See Section 3.1.8 (2017 PTG) for explanation on development of load values.
- See Section 3.1.8.6 (2017 PTG) to convert design strength value to ASD value.
- Linear interpolation between embedment depths and concrete compressive strengths is not permitted.
- Apply spacing, edge distance, and concrete thickness factors in tables 23-35 as necessary. Compare to the steel values in table 56. The lesser of the values is to be used for the design.
- Data is for temperature range A: Max. short term temperature = 130°F (55°C), max. long term temperature = 110°F (43°C).
For temperature range B: Max. short term temperature = 176°F (80°C), max. long term temperature = 110°F (43°C) multiply above value by 0.92.
For temperature range C: Max. short term temperature = 210°F (99°C), max. long term temperature = 162°F (72°C) multiply above value by 0.71.
Short term elevated concrete temperatures are those that occur over brief intervals, e.g., as a result of diurnal cycling. Long term concrete temperatures are roughly constant over significant periods of time.
- Tabular values are for dry concrete conditions. For water saturated concrete multiply design strength (factored resistance) by 0.85.
- Tabular values are for short term loads only. For sustained loads including overhead use, see Section 3.1.8.8 (2017 PTG).
- Tabular values are for normal-weight concrete only. For lightweight concrete multiply design strength by λ_a as follows:
For sand-lightweight, $\lambda_a = 0.51$. For all-lightweight, $\lambda_a = 0.45$.



Table 55 — Hilti HIT-HY 100 adhesive factored resistance with concrete / bond failure for threaded rod in cracked concrete 1,2,3,4,5,6,7,8,9

| Nominal anchor diameter in. | Effective embedment in. (mm) | Tension — N_t | | | | Shear — V_r | | | |
|-----------------------------|------------------------------|---|---|---|---|---|---|---|---|
| | | $f'_c = 20$ MPa (2,900 psi) lb (kN) | $f'_c = 25$ MPa (3,625 psi) lb (kN) | $f'_c = 30$ MPa (4,350 psi) lb (kN) | $f'_c = 40$ MPa (5,800 psi) lb (kN) | $f'_c = 20$ MPa (2,900 psi) lb (kN) | $f'_c = 25$ MPa (3,625 psi) lb (kN) | $f'_c = 30$ MPa (4,350 psi) lb (kN) | $f'_c = 40$ MPa (5,800 psi) lb (kN) |
| 3/8 | 2-3/8 (60) | 1,135 (5.1) | 1,160 (5.2) | 1,185 (5.3) | 1,215 (5.4) | 1,135 (5.1) | 1,160 (5.2) | 1,185 (5.3) | 1,215 (5.4) |
| | 3-3/8 (86) | 1,615 (7.2) | 1,650 (7.3) | 1,680 (7.5) | 1,730 (7.7) | 3,230 (14.4) | 3,300 (14.7) | 3,360 (15.0) | 3,460 (15.4) |
| | 4-1/2 (114) | 2,150 (9.6) | 2,200 (9.8) | 2,240 (10.0) | 2,305 (10.3) | 4,305 (19.1) | 4,400 (19.6) | 4,480 (19.9) | 4,615 (20.5) |
| | 7-1/2 (191) | 3,585 (16.0) | 3,670 (16.3) | 3,735 (16.6) | 3,845 (17.1) | 7,175 (31.9) | 7,335 (32.6) | 7,470 (33.2) | 7,690 (34.2) |
| 1/2 | 2-3/4 (70) | 1,910 (8.5) | 1,955 (8.7) | 1,990 (8.8) | 2,045 (9.1) | 3,820 (17.0) | 3,905 (17.4) | 3,980 (17.7) | 4,095 (18.2) |
| | 4-1/2 (114) | 3,125 (13.9) | 3,195 (14.2) | 3,255 (14.5) | 3,350 (14.9) | 6,250 (27.8) | 6,395 (28.4) | 6,510 (29.0) | 6,700 (29.8) |
| | 6 (152) | 4,170 (18.5) | 4,260 (19.0) | 4,340 (19.3) | 4,465 (19.9) | 8,335 (37.1) | 8,525 (37.9) | 8,680 (38.6) | 8,935 (39.7) |
| | 10 (254) | 6,945 (30.9) | 7,105 (31.6) | 7,235 (32.2) | 7,445 (33.1) | 13,895 (61.8) | 14,205 (63.2) | 14,470 (64.4) | 14,890 (66.2) |
| 5/8 | 3-1/8 (79) | 2,935 (13.1) | 3,005 (13.4) | 3,060 (13.6) | 3,145 (14.0) | 5,875 (26.1) | 6,005 (26.7) | 6,115 (27.2) | 6,295 (28.0) |
| | 5-5/8 (143) | 5,285 (23.5) | 5,405 (24.0) | 5,505 (24.5) | 5,665 (25.2) | 10,570 (47.0) | 10,810 (48.1) | 11,010 (49.0) | 11,330 (50.4) |
| | 7-1/2 (191) | 7,045 (31.3) | 7,205 (32.1) | 7,340 (32.6) | 7,555 (33.6) | 14,095 (62.7) | 14,410 (64.1) | 14,675 (65.3) | 15,105 (67.2) |
| | 12-1/2 (318) | 11,745 (52.2) | 12,010 (53.4) | 12,230 (54.4) | 12,590 (56.0) | 23,490 (104.5) | 24,020 (106.8) | 24,460 (108.8) | 25,175 (112.0) |
| 3/4 | 3-1/2 (89) | 3,835 (17.1) | 4,285 (19.1) | 4,395 (19.5) | 4,520 (20.1) | 7,670 (34.1) | 8,575 (38.1) | 8,785 (39.1) | 9,045 (40.2) |
| | 6-3/4 (171) | 8,135 (36.2) | 8,320 (37.0) | 8,470 (37.7) | 8,720 (38.8) | 16,270 (72.4) | 16,640 (74.0) | 16,945 (75.4) | 17,440 (77.6) |
| | 9 (229) | 10,850 (48.3) | 11,090 (49.3) | 11,295 (50.2) | 11,625 (51.7) | 21,695 (96.5) | 22,185 (98.7) | 22,595 (100.5) | 23,250 (103.4) |
| | 15 (381) | 18,080 (80.4) | 18,485 (82.2) | 18,825 (83.7) | 19,375 (86.2) | 36,160 (160.8) | 36,975 (164.5) | 37,655 (167.5) | 38,755 (172.4) |
| 7/8 | 3-1/2 (89) | 3,835 (17.1) | 4,285 (19.1) | 4,695 (20.9) | 5,310 (23.6) | 7,670 (34.1) | 8,575 (38.1) | 9,390 (41.8) | 10,620 (47.2) |
| | 7-7/8 (200) | 11,145 (49.6) | 11,395 (50.7) | 11,605 (51.6) | 11,945 (53.1) | 22,290 (99.2) | 22,795 (101.4) | 23,210 (103.3) | 23,890 (106.3) |
| | 10-1/2 (267) | 14,860 (66.1) | 15,195 (67.6) | 15,475 (68.8) | 15,925 (70.8) | 29,720 (132.2) | 30,390 (135.2) | 30,950 (137.7) | 31,855 (141.7) |
| | 17-1/2 (445) | 24,765 (110.2) | 25,325 (112.7) | 25,790 (114.7) | 26,545 (118.1) | 49,535 (220.3) | 50,650 (225.3) | 51,585 (229.5) | 53,090 (236.1) |
| 1 | 4 (102) | 4,685 (20.8) | 5,240 (23.3) | 5,740 (25.5) | 6,625 (29.5) | 9,370 (41.7) | 10,475 (46.6) | 11,475 (51.0) | 13,250 (58.9) |
| | 9 (229) | 14,745 (65.6) | 15,075 (67.1) | 15,355 (68.3) | 15,800 (70.3) | 29,485 (131.2) | 30,150 (134.1) | 30,705 (136.6) | 31,605 (140.6) |
| | 12 (305) | 19,660 (87.4) | 20,100 (89.4) | 20,470 (91.1) | 21,070 (93.7) | 39,315 (174.9) | 40,205 (178.8) | 40,945 (182.1) | 42,140 (187.4) |
| | 20 (508) | 32,765 (145.7) | 33,500 (149.0) | 34,120 (151.8) | 35,115 (156.2) | 65,525 (291.5) | 67,005 (298.1) | 68,240 (303.5) | 70,230 (312.4) |

1 See Section 3.1.8 (2017 PTG) for explanation on development of load values.
 2 See Section 3.1.8.6 (2017 PTG) to convert design strength value to ASD value.
 3 Linear interpolation between embedment depths and concrete compressive strengths is not permitted.
 4 Apply spacing, edge distance, and concrete thickness factors in tables 23-35 as necessary. Compare to the steel values in table 56. The lesser of the values is to be used for the design.
 5 Data is for temperature range A: Max. short term temperature = 130°F (55°C), max. long term temperature = 110°F (43°C). For temperature range B: Max. short term temperature = 176°F (80°C), max. long term temperature = 110°F (43°C) multiply above value by 0.92. For temperature range C: Max. short term temperature = 210°F (99°C), max. long term temperature = 162°F (72°C) multiply above value by 0.71. Short term elevated concrete temperatures are those that occur over brief intervals, e.g., as a result of diurnal cycling. Long term concrete temperatures are roughly constant over significant periods of time.
 6 Tabular values are for dry concrete conditions. For water saturated concrete multiply design strength (factored resistance) by 0.85.
 7 Tabular values are for short term loads only. For sustained loads including overhead use, see Section 3.1.8.8 (2017 PTG).
 8 Tabular values are for normal-weight concrete only. For lightweight concrete multiply design strength by λ_a as follows: For sand-lightweight, $\lambda_a = 0.51$. For all-lightweight, $\lambda_a = 0.45$.
 9 Tabular values are for static loads only. For seismic loads, multiply cracked concrete tabular values in tension and shear by $\alpha_{seis} = 0.75$. See section 3.1.8.7 (2017 PTG) for additional information on seismic applications.

Table 56 — Steel factored resistance for Hilti HIT-V and HAS threaded rods according to CSA A23.3 Annex D

| Nominal anchor diameter in. | HIT-V ASTM A307 Grade A ⁴ | | | HAS-E ISO 898 Class 5.8 ⁴ | | | HAS-E-B and HAS-E-B HDG ASTM A193 B7 and ASTM F 1554 Gr. 105 ⁵ | | |
|-----------------------------|---|---|--|---|---|--|---|---|--|
| | Tensile ¹ N _{sar} lb (kN) | Shear ² V _{sar} lb (kN) | Seismic Shear ³ V _{sar,eq} lb (kN) | Tensile ¹ N _{sar} lb (kN) | Shear ² V _{sar} lb (kN) | Seismic Shear ³ V _{sar,eq} lb (kN) | Tensile ¹ N _{sar} lb (kN) | Shear ² V _{sar} lb (kN) | Seismic Shear ³ V _{sar,eq} lb (kN) |
| 3/8 | 2,765 (12.3) | 1,540 (6.9) | 1,080 (4.8) | 3,345 (14.9) | 1,860 (8.3) | 1,300 (5.8) | 6,570 (29.2) | 3,695 (16.4) | 2,585 (11.5) |
| 1/2 | 5,065 (22.5) | 2,825 (12.6) | 1,975 (8.8) | 6,125 (27.2) | 3,410 (15.2) | 2,385 (10.6) | 12,035 (53.5) | 6,765 (30.1) | 4,735 (21.1) |
| 5/8 | 8,070 (35.9) | 4,495 (20.0) | 3,145 (14.0) | 9,750 (43.4) | 5,430 (24.2) | 3,800 (16.9) | 19,160 (85.2) | 10,780 (48.0) | 7,545 (33.6) |
| 3/4 | 11,940 (53.1) | 6,650 (29.6) | 4,655 (20.7) | 14,430 (64.2) | 8,040 (35.8) | 5,630 (25.0) | 28,365 (126.2) | 15,955 (71.0) | 11,170 (49.7) |
| 7/8 | - - | - - | - - | 19,915 (88.6) | 11,095 (49.4) | 7,765 (34.5) | 39,150 (174.1) | 22,020 (97.9) | 15,415 (68.6) |
| 1 | 21,620 (96.2) | 12,045 (53.6) | 8,430 (37.5) | 26,125 (116.2) | 14,555 (64.7) | 10,190 (45.3) | 51,360 (228.5) | 28,890 (128.5) | 20,225 (90.0) |
| 1-1/4 | - - | - - | - - | 41,805 (186.0) | 23,290 (103.6) | 16,305 (72.5) | 82,175 (365.5) | 46,220 (205.6) | 32,355 (143.9) |

- 1 Tensile = $A_{se,N} \phi_s f_{uta} R$ as noted in CSA A23.3-14 Eq. D.2.
- 2 Shear = $A_{se,V} \phi_s 0.60 f_{uta} R$ as noted in CSA A23.3-14 Eq. D.31.
- 3 Seismic Shear = $\alpha_{V,seis} V_{sar}$: Reduction factor for seismic shear only. See CSA A23.3 Annex D for additional information on seismic applications.
- 4 HIT-V and HAS-E threaded rods are considered brittle steel elements. HIT-V does not comply with % elongation requirements of ASTM A307 Grade A steel. HAS-E does not comply with % elongation requirements of ISO 898-1.
- 5 HAS-E-B and HAS-E-B HDG rods are considered ductile steel elements.

Table 56 (Continued) — Steel factored resistance for Hilti HAS threaded rods for use with CSA A23.3 Annex D

| Nominal anchor diameter in. | HAS-V / HAS-V HDG ASTM F1554 Gr. 36 ^{4,6} | | | HAS-E / HAS-E HDG ASTM F1554 Gr. 55 ^{4,6} | | | HAS-B and HAS-B HDG ASTM A193 B7 and ASTM F 1554 Gr. 105 ^{4,6} | | | HAS-R Stainless Steel ASTM F593 (3/8-in to 1-in) ⁵ ASTM A193 (1-1/8-in to 2-in) ⁴ | | |
|-----------------------------|---|---|--|---|---|--|---|---|--|---|---|--|
| | Tensile ¹ N _{sar} lb (kN) | Shear ² V _{sar} lb (kN) | Seismic Shear ³ V _{sar,eq} lb (kN) | Tensile ¹ N _{sar} lb (kN) | Shear ² V _{sar} lb (kN) | Seismic Shear ³ V _{sar,eq} lb (kN) | Tensile ¹ N _{sar} lb (kN) | Shear ² V _{sar} lb (kN) | Seismic Shear ³ V _{sar,eq} lb (kN) | Tensile ¹ N _{sar} lb (kN) | Shear ² V _{sar} lb (kN) | Seismic Shear ³ V _{sar,eq} lb (kN) |
| 3/8 | 3,055 (13.6) | 1,720 (7.7) | 1,030 (4.6) | 3,955 (17.6) | 2,225 (9.9) | 1,560 (6.9) | 6,570 (29.2) | 3,695 (16.4) | 2,585 (11.5) | 4,610 (20.5) | 2,570 (11.4) | 1,800 (8.0) |
| 1/2 | 5,595 (24.9) | 3,150 (14.0) | 1,890 (8.4) | 7,240 (32.2) | 4,070 (18.1) | 2,850 (12.7) | 12,035 (53.5) | 6,765 (30.1) | 4,735 (21.1) | 8,445 (37.6) | 4,705 (20.9) | 3,295 (14.7) |
| 5/8 | 8,915 (39.7) | 5,015 (22.3) | 3,010 (13.4) | 11,525 (51.3) | 6,485 (28.8) | 4,540 (20.2) | 19,160 (85.2) | 10,780 (48.0) | 7,545 (33.6) | 13,445 (59.8) | 7,490 (33.3) | 5,245 (23.3) |
| 3/4 | 13,190 (58.7) | 7,420 (33.0) | 4,450 (19.8) | 17,060 (75.9) | 9,600 (42.7) | 6,720 (29.9) | 28,365 (126.2) | 15,955 (71.0) | 11,170 (49.7) | 16,920 (75.3) | 9,425 (41.9) | 6,600 (29.4) |
| 7/8 | 18,210 (81.0) | 10,245 (45.6) | 6,145 (27.3) | 23,550 (104.8) | 13,245 (58.9) | 9,270 (41.2) | 39,150 (174.1) | 22,020 (97.9) | 15,415 (68.6) | 23,350 (103.9) | 13,010 (57.9) | 9,105 (40.5) |
| 1 | 23,890 (106.3) | 13,440 (59.8) | 8,065 (35.9) | 30,890 (137.4) | 17,380 (77.3) | 12,165 (54.1) | 51,360 (228.5) | 28,890 (128.5) | 20,225 (90.0) | 30,635 (136.3) | 17,065 (75.9) | 11,945 (53.1) |
| 1-1/4 | 38,225 (170.0) | 21,500 (95.6) | 12,900 (57.4) | 49,425 (219.9) | 27,800 (123.7) | 19,460 (86.6) | 82,175 (365.5) | 46,220 (205.6) | 32,355 (143.9) | 37,565 (167.1) | 21,130 (94.0) | 12,680 (56.4) |

- 1 Tensile = $A_{se,N} \phi_s f_{uta} R$ as noted in CSA A23.3-14 Eq. D.2.
- 2 Shear = $A_{se,V} \phi_s 0.60 f_{uta} R$ as noted in CSA A23.3-14 Eq. D.31.
- 3 Seismic Shear = $\alpha_{V,seis} V_{sar}$: Reduction factor for seismic shear only. See CSA A23.3 Annex D for additional information on seismic applications.
- 4 HAS-V, HAS-E (3/8-in to 1-1/4-in), HAS-B, and HAS-R (Class 1; 1-1/8-in to 1-1/4-in) threaded rods are considered ductile steel elements (included HDG rods).
- 5 HAS-R (CW1 and CW2; 3/8-in to 1-in) threaded rods are considered brittle steel elements.
- 6 3/8-inch dia. threaded rods are not included in the ASTM F1554 standard. Hilti 3/8-inch dia. HAS-V, HAS-E, and HAS-E-B (incl. HDG) threaded rods meet the chemical composition and mechanical property requirements of ASTM F1554.

Hilti HIT-HY 100 adhesive with Hilti HIS-N and HIS-RN internally threaded insert



Table 57 — Hilti HIT-HY 100 design information with Hilti HIS-N and HIS-RN internally threaded inserts in hammer drilled holes in accordance with CSA A23.3-14 Annex D ¹



| Design parameter | Symbol | Units | Nominal rod diameter (in.) | | | | Ref A23.3-14 | |
|--|--|-----------------|------------------------------|----------------|----------------|----------------|-----------------|-----------|
| | | | 3/8 | 1/2 | 5/8 | 3/4 | | |
| HIS insert outside diameter | D | mm | 16.5 | 20.5 | 25.4 | 27.6 | | |
| Effective embedment ² | h_{ef} | mm | 110 | 125 | 170 | 205 | | |
| Min. concrete thickness ² | h_{min} | mm | 150 | 170 | 230 | 270 | | |
| Critical edge distance | c_{ac} | - | See ESR-3574, section 4.1.10 | | | | | |
| Minimum edge distance | c_{min} | mm | 83 | 102 | 127 | 140 | | |
| Minimum anchor spacing | s_{min} | mm | 83 | 102 | 127 | 140 | | |
| Coeff. for factored conc. breakout resistance, uncracked concrete | $k_{c,uncr}$ ³ | - | 10 | | | | D.6.2.2 | |
| Concrete material resistance factor | f_c | - | 0.65 | | | | 8.4.2 | |
| Resistance modification factor for tension and shear, concrete failure modes, Condition B ⁴ | R_{conc} | - | 1.00 | | | | D.5.3 (c) | |
| Temp. range A ⁵ | Characteristic bond stress in cracked concrete ⁶ | T_{uncr} | psi (MPa) | 1,375 (9.5) | 1,270 (8.8) | 1,100 (7.6) | 1,030 (7.1) | D.6.5.2 |
| Temp. range B ⁵ | Characteristic bond stress in cracked concrete ⁶ | T_{uncr} | psi (MPa) | 1,270 (8.8) | 1,170 (8.1) | 1,015 (7.0) | 945 (6.5) | D.6.5.2 |
| Temp. range C ⁵ | Characteristic bond stress in cracked concrete ⁶ | T_{uncr} | psi (MPa) | 990 (6.8) | 910 (6.3) | 790 (5.4) | 740 (5.1) | D.6.5.2 |
| Permissible installation conditions | Resistance modification factor tension & shear, bond failure dry concrete and water-saturated concrete | Anchor category | - | 1 | | | 2 | D.5.3 (c) |
| | | R_{dry} | | 1.00 | | | 0.85 | |
| | Resistance modification factor tension & shear, bond failure water-saturated concrete | Anchor category | - | 2 | | | | D.5.3 (c) |
| | | R_{ws} | - | 0.85 | | | | |

¹ Design information in this table is taken from ICC-ES ESR-3574, dated March, 2018, table 16 and 17, and converted for use with CSA A23.3-14 Annex D.

² See figure at the beginning of the HIS-N section.

³ For all design cases, $\psi_{c,N} = 1.0$. The appropriate coefficient for breakout resistance for uncracked concrete ($k_{c,uncr}$) must be used.

⁴ For use with the load combinations of CSA A23.3-14 chapter 8. Condition B applies where supplementary reinforcement in conformance with CSA A23.3-14 section D.5.3 is not provided, or where pullout or pryout strength governs. For cases where the presence of supplementary reinforcement can be verified, the resistance modification factors associated with Condition A may be used.

⁵ Temperature range A: Max. short term temperature = 130°F (55°C), max. long term temperature = 110°F (43°C).

Temperature range B: Max. short term temperature = 176°F (80°C), max. long term temperature = 110°F (43°C).

Temperature range C: Max. short term temperature = 210°F (99°C), max. long term temperature = 162°F (72°C).

Short term elevated concrete temperatures are those that occur over brief intervals, e.g., as a result of diurnal cycling. Long term concrete temperatures are roughly constant over significant periods of time.

⁶ Bond strength values corresponding to concrete compressive strength $f'_c = 2,500$ psi (17.2 MPa). For concrete compressive strength, f'_c , between 2,500 psi (17.2 MPa) and 8,000 psi (55.2 MPa), the tabulated characteristic bond strength may be increased by a factor of $(f'_c/2,500)^{0.1}$ [for SI: $(f'_c/17.2)^{0.1}$].

Table 58 — Hilti HIT-HY 100 adhesive factored resistance with concrete / bond failure for Hilti HIS-N and HIS-RN internally threaded inserts in uncracked concrete ^{1,2,3,4,5,6,7,8}



| Thread size | Effective Embedment Depth in. (mm) | Tension — N_n | | | | Shear — V_n | | | |
|-------------|------------------------------------|---|---|---|---|---|---|---|---|
| | | $f'_c = 20$ MPa (2,900 psi) lb (kN) | $f'_c = 25$ MPa (3,625 psi) lb (kN) | $f'_c = 30$ MPa (4,350 psi) lb (kN) | $f'_c = 40$ MPa (5,800 psi) lb (kN) | $f'_c = 20$ MPa (2,900 psi) lb (kN) | $f'_c = 25$ MPa (3,625 psi) lb (kN) | $f'_c = 30$ MPa (4,350 psi) lb (kN) | $f'_c = 40$ MPa (5,800 psi) lb (kN) |
| 3/8-16 UNC | 4-3/8 (110) | 7,540 (33.5) | 7,905 (35.2) | 7,905 (35.2) | 8,380 (37.3) | 15,080 (67.1) | 15,810 (70.3) | 15,810 (70.3) | 16,760 (74.6) |
| 1/2-13 UNC | 5 (125) | 9,135 (40.6) | 10,210 (45.4) | 10,340 (46.0) | 10,960 (48.8) | 18,265 (81.3) | 20,420 (90.8) | 20,680 (92.0) | 21,920 (97.5) |
| 5/8-11 UNC | 6-3/4 (170) | 14,485 (64.4) | 15,040 (66.9) | 15,040 (66.9) | 15,940 (70.9) | 28,970 (128.9) | 30,075 (133.8) | 30,075 (133.8) | 31,880 (141.8) |
| 3/4-10 UNC | 8-1/8 (205) | 15,730 (70.0) | 15,730 (70.0) | 15,730 (70.0) | 16,675 (74.2) | 31,465 (140.0) | 31,465 (140.0) | 31,465 (140.0) | 33,350 (148.4) |

- Table values determined from calculations according to CSA A23.3-14 Annex D. See Section 2.4 for explanation on development of load values.
- See Section 3.1.8.6 (2017 PTG) to convert design strength value to ASD value.
- Linear interpolation between embedment depths and concrete compressive strengths is not permitted.
- Apply spacing, edge distance, and concrete thickness factors in table 38 as necessary. Compare to the steel values in table 59. The lesser of the values is to be used for the design.
- Data is for temperature range A: Max. short term temperature = 130°F (55°C), max. long term temperature = 110°F (43°C).
For temperature range B: Max. short term temperature = 176°F (80°C), max. long term temperature = 110°F (43°C) multiply above value by 0.92.
For temperature range C: Max. short term temperature = 210°F (99°C), max. long term temperature = 162°F (72°C) multiply above value by 0.71.
Short term elevated concrete temperatures are those that occur over brief intervals, e.g., as a result of diurnal cycling. Long term concrete temperatures are roughly constant over significant periods of time.
- Tabular values are for dry concrete conditions. For water saturated concrete multiply factored resistance by 0.85.
- Tabular values are for short term loads only. For sustained loads including overhead use, see Section 3.1.8.8 (2017 PTG).
- Tabular values are for normal weight concrete only. For lightweight concrete multiply factored resistance by λ_a as follows:
For sand-lightweight, $\lambda_a = 0.51$. For all-lightweight, $\lambda_a = 0.45$.

Table 59 — Steel factored resistance for steel bolt / cap screw for Hilti HIS-N and HIS-RN internally threaded inserts ^{1,2,3}

| Thread size | ASTM A 193 B7 | | ASTM A 193 Grade B8M Stainless Steel | |
|-------------|--|--|--|--|
| | Tensile ⁴ N_{sar} lb (kN) | Shear ⁵ V_{sar} lb (kN) | Tensile ⁴ N_{sar} lb (kN) | Shear ⁵ V_{sar} lb (kN) |
| 3/8-16 UNC | 5,765 (25.6) | 3,215 (14.3) | 5,070 (22.6) | 2,825 (12.6) |
| 1/2-13 UNC | 9,635 (42.9) | 5,880 (26.2) | 9,290 (41.3) | 5,175 (23.0) |
| 5/8-11 UNC | 16,020 (71.3) | 9,365 (41.7) | 14,790 (65.8) | 8,240 (36.7) |
| 3/4-10 UNC | 16,280 (72.4) | 13,860 (61.7) | 21,895 (97.4) | 12,195 (54.2) |

- See Section 2.4.4 to convert design strength value to ASD value.
- Hilti HIS-N and HIS-RN inserts with steel bolts are considered brittle steel elements.
- Table values are the lesser of steel failure in the HIS-N insert or inserted steel bolt.
- Tensile = $A_{se,N} \phi_s f_{uta} R$ as noted in CSA A23.3-14 Annex D
- Shear = $A_{se,V} \phi_s 0.60 f_{uta} R$ as noted in CSA A23.3-14 Annex D. For 3/8-in diameter insert, shear = $A_{se,V} \phi_s 0.50 f_{uta} R$.

DESIGN DATA IN MASONRY

Hilti HIT-HY 100 adhesive in grout-filled CMU with Hilti HAS/HIT V threaded rod

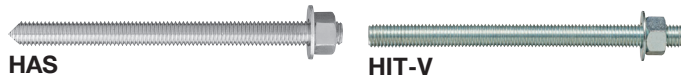

Hilti HAS/HIT-V threaded rod installation conditions



| | | | | | |
|----------------------------|---|--|-----------------------------|--|--|
| Permissible Base Materials |  | Grout-filled concrete masonry construction | Permissible Drilling Method |  | Rotary only drilling with carbide tipped drill bit |
|----------------------------|---|--|-----------------------------|--|--|

Table 60 – Allowable tension loads for threaded rods installed with HIT-HY 100 adhesive in the face of grout-filled concrete masonry construction ^{1,2,3,4,5,6,7,8}

| Nominal anchor diameter d_0 in. | Embedment depth ⁹ h_{ef} in. (mm) | Allowable service tension load P_t lb (kN) | Spacing | | | Edge distance | | | | | | |
|---|--|--|---|-------|---|--|------|---|-------|---|-------|------|
| | | | Critical spacing ^{10,11} s_{cr} | | Load ¹⁰ reduction factor at s_{min} | Critical edge dist. ^{10,11} c_{cr} | | Load ¹⁰ reduction factor at c_{min} | | | | |
| | | | in. | (mm) | | in. | (mm) | | | | | |
| 3/8 | 3-3/8 (86) | 950 (4.2) | 8 | (203) | 4 | (102) | 0.70 | 20 | (508) | 4 | (102) | 0.93 |
| 1/2 | 4-1/2 (114) | 1,265 (5.6) | 8 | (203) | 4 | (102) | 0.70 | 20 | (508) | 4 | (102) | 0.83 |
| 5/8 | 5-5/8 (143) | 1,850 (8.2) | 8 | (203) | 4 | (102) | 0.70 | 20 | (508) | 4 | (102) | 0.74 |
| 3/4 | 6-3/4 (171) | 2,440 (10.9) | 8 | (203) | 4 | (102) | 0.70 | 20 | (508) | 4 | (102) | 0.65 |

For Sl: 1 inch = 25.4 mm, 1 lbf = 4.45 N.

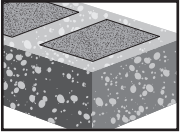
Table 61 – Allowable shear loads for threaded rods installed with HIT-HY 100 adhesive in the face of grout-filled concrete masonry construction ^{1,2,3,4,5,6,7,8}

| Nominal anchor diameter d_0 in. | Embedment depth ⁹ h_{ef} in. (mm) | Allowable service shear load V_t lb (kN) | Spacing | | | Edge distance | | | | | | |
|---|--|--|---|-------|---|--|------|---|-------|---|-------|------|
| | | | Critical spacing ^{10,11} s_{cr} | | Load ¹⁰ reduction factor at s_{min} | Critical edge dist. ^{10,11} c_{cr} | | Load ¹⁰ reduction factor at c_{min} | | | | |
| | | | in. | (mm) | | in. | (mm) | | | | | |
| 3/8 | 3-3/8 (86) | 1,135 (5.0) | 8 | (203) | 4 | (102) | 0.70 | 20 | (508) | 4 | (102) | 1.00 |
| 1/2 | 4-1/2 (114) | 1,870 (8.3) | 8 | (203) | 4 | (102) | 0.70 | 20 | (508) | 4 | (102) | 0.93 |
| 5/8 | 5-5/8 (143) | 2,590 (11.5) | 8 | (203) | 4 | (102) | 0.70 | 20 | (508) | 4 | (102) | 0.82 |
| 3/4 | 6-3/4 (171) | 2,785 (12.4) | 8 | (203) | 4 | (102) | 0.70 | 20 | (508) | 4 | (102) | 0.79 |

For Sl: 1 inch = 25.4 mm, 1 lbf = 4.45 N.

The following footnotes apply to both Tables 60 and 61:

- 1 Anchors may be installed in any location in the face of the masonry wall (cell, bed joint, or web) as shown in Figure 2, except anchor must not be installed in or within 1 inch of a head joint.
- 2 Anchors are limited to one per masonry cell. Anchors in adjacent cells may be spaced apart as close as 4 inches as shown in table above.
- 3 Allowable load values are for use in fully-grouted masonry construction complying with Section 4.2.4 of ER-547.
- 4 Concrete masonry thickness must be minimum nominally 8-inch thick.
- 5 The tabulated allowable loads have been calculated based on a safety factor of 5.0.
- 6 Allowable loads must be the lesser of the adjusted masonry or bond values tabulated above and the steel values given in Table 63 and 64.
- 7 Allowable loads must be adjusted for increased base material temperatures in accordance with Figure 1, as applicable.
- 8 When using the basic load combinations in accordance with IBC Section 1605.3.1, tabulated allowable loads must not be increased for seismic or wind loading. When using the alternative basic load combinations in the 2009 or 2006 IBC Section 1605.3.2 that include seismic or wind loads, tabulated allowable loads may be adjusted in accordance with Section 3.2.2.1 of ER-547 and Table 2.
- 9 Embedment depth is measured from the outside face of the masonry wall.
- 10 Load values for anchors installed at less than critical spacing (s_{cr}) and critical edge distance (c_{cr}) must be multiplied by the appropriate load reduction factor based on actual edge distance (c) or spacing (s). Linear interpolation of load values between minimum spacing (s_{min}) and s_{cr} and between minimum edge distance (c_{min}) and c_{cr} is permitted. Load reduction factors are multiplicative; both spacing and edge distance load reduction factors must be considered.
- 11 See Figure 2 of for an illustration of the critical and minimum edge distances.

Table 62 — Allowable tension and shear loads for threaded rods installed with HIT-HY 100 adhesive in the top of grout-filled concrete masonry construction ^{1,2,3,4,5,6,7,8,9}

| Nominal anchor diameter d_0 in. | Embedment depth ¹⁰ h_{ef} in. (mm) | | Minimum edge distance c_{min} lb (kN) | | Allowable service tension load P_t lb (kN) | | Allowable service shear load | | | |
|---|---|-------|---|------|--|-------|---|-------|--|-------|
| | | | | | | | Load applied perpendicular to edge $V_{t,\perp}$ | | Load applied parallel to edge $V_{t,\parallel}$ | |
| | | | | | | | in. | (mm) | in. | (mm) |
| 1/2 | 4-1/2 | (114) | 1-3/4 | (44) | 1,095 | (4.9) | 295 | (1.3) | 815 | (3.6) |
| 5/8 | 5-5/8 | (143) | 1-3/4 | (44) | 1,240 | (5.5) | 400 | (1.8) | 965 | (4.3) |

For SI: 1 inch = 25.4 mm, 1 lbf = 4.45 N.

- 1 Loads in this table are for threaded rods in the top of grout-filled masonry construction at a minimum edge distance shown in this table. Anchors must not be installed in or within 1 inch of a head joint. Capacity of attached sill plate or other material to resist loads in this table must comply with the applicable code.
- 2 Anchors are limited to one per masonry cell. Load values are based on an anchor spacing of 8 inches. Anchors in adjacent cells may be spaced apart as close as 4 inches with a load reduction of 30%. For anchors in adjacent cells spaced apart between 4 inches (s_{min}) and 8 inches (s_u) use linear interpolation. See figure 3.
- 3 End distance to end of wall must be equal to or greater than 2.0 times the anchor embedment depth.
- 4 Allowable load values are for use in fully-grouted masonry construction complying with Section 4.2.4 of ER-547.
- 5 Concrete masonry thickness must be minimum nominally 8-inch thick.
- 6 The tabulated allowable loads have been calculated based on a safety factor of 5.0.
- 7 Allowable loads must be the lesser of the adjusted masonry or bond values tabulated above and the steel values given in Table 63-64.
- 8 Allowable loads must be adjusted for increased base material temperatures in accordance with Figure 1, as applicable.
- 9 When using the basic load combinations in accordance with IBC Section 1605.3.1, tabulated allowable loads must not be increased for seismic or wind loading. When using the alternative basic load combinations in the 2009 or 2006 IBC Section 1605.3.2 that include seismic or wind loads, tabulated allowable loads may be adjusted in accordance with Section 3.2.2.1 and Table 2 of this report.
- 10 Embedment depth is measured from the top surface of the masonry wall.

Figure 1 — Influence of grout-filled CMU base-material temperature on allowable tension and shear loads for HIT-HY 100

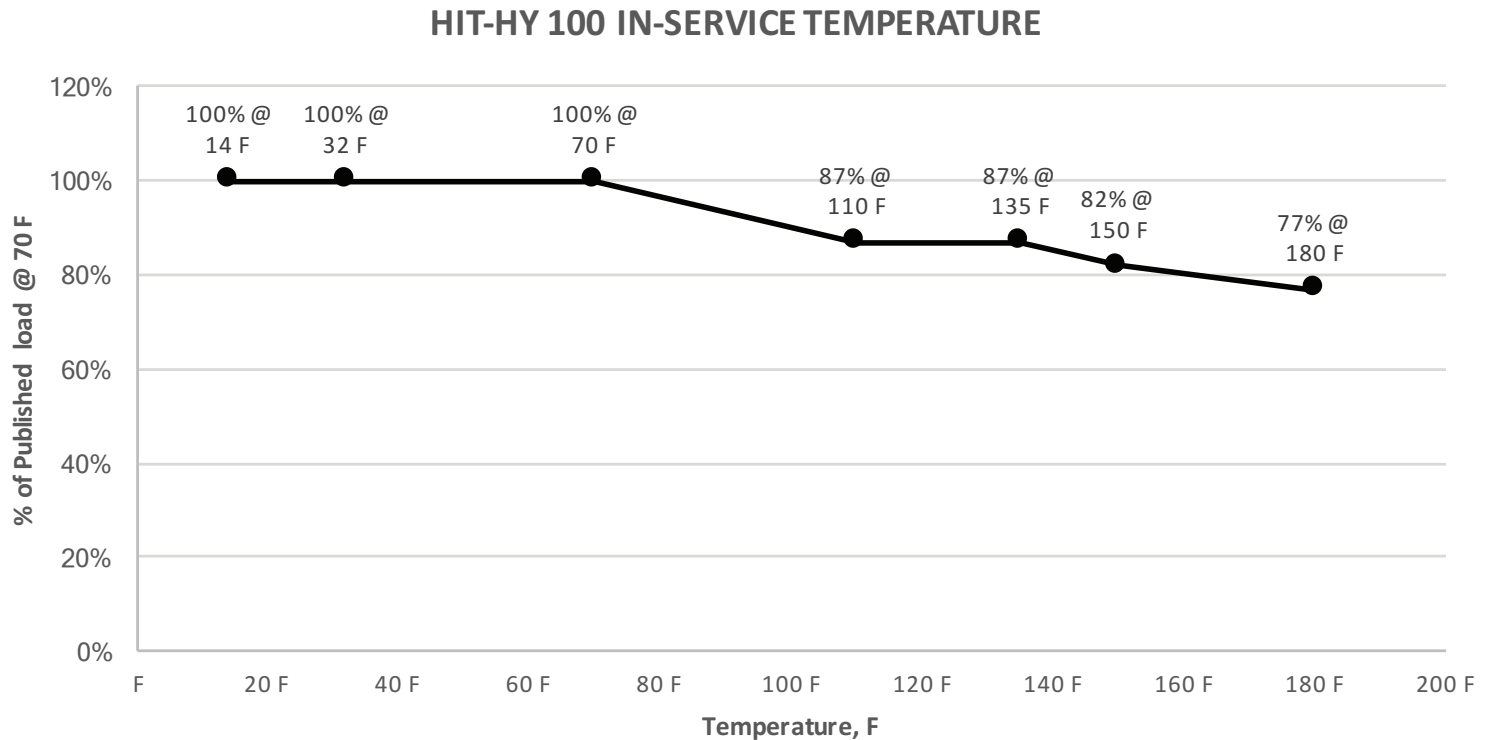

Table 63 — Specifications and physical properties of common carbon and stainless steel threaded rod materials

| Description | Specification | Minimum specified yield strength | | Minimum specified ultimate strength | | Nut specification |
|---------------------------------------|-------------------------------------|----------------------------------|-------|-------------------------------------|-------|------------------------|
| | | ksi | (Mpa) | ksi | (Mpa) | |
| Standard threaded rod ¹ | ASTM A307 Grade A | 37.5 | (259) | 60.0 | (414) | SAE J995 Grade 5 |
| | ISO 898-1 Class 5.8 | 58.0 | (400) | 72.5 | (500) | SAE J995 Grade 5 |
| | ASTM F1554 Gr. 36 | 36.0 | (248) | 58.0 | (400) | ASTM A194 or ASTM A563 |
| | ASTM F1554 Gr. 55 | 55.0 | (379) | 75.0 | (517) | |
| High strength rod ¹ | ASTM F1554 Gr. 105 | 105.0 | (724) | 125.0 | (862) | ASTM A194 or ASTM A563 |
| | ASTM A193 B7 | 105.0 | (724) | 125.0 | (862) | |
| Stainless steel rod AISI 304 / 316 | 3/8-in. to 5/8-in. ASTM F593 CW1 | 65.0 | (448) | 100.0 | (690) | ASTM F594 |
| | 3/4-in. ASTM F593 CW2 | 45.0 | (310) | 85.0 | (586) | |

For SI: 1 ksi = 6.89 MPa.

¹ The rods are normally zinc-coated. For exterior use or damp applications, stainless steel or hot-dipped galvanized carbon steel rods with a zinc coating complying with ASTM A153 should be considered.

Table 64 — Allowable tension and shear loads for threaded rods based on steel strength ¹

| Nominal anchor diameter in. | ASTM A307 Grade A | | ISO 898 Class 5.8 | | ASTM F1554 Gr. 36 ² | | ASTM F1554 Gr. 55 ² | | ASTM A193 B7 and ASTM F1554 Gr. 105 ² | | AISI 304/316 SS ASTM F 593 CW1 and CW2 | |
|-----------------------------|-------------------|-----------------|-------------------|-----------------|--------------------------------|-----------------|--------------------------------|-----------------|--|-----------------|--|-----------------|
| | Tensile lb (kN) | Shear lb (kN) | Tensile lb (kN) | Shear lb (kN) | Tensile lb (kN) | Shear lb (kN) | Tensile lb (kN) | Shear lb (kN) | Tensile lb (kN) | Shear lb (kN) | Tensile lb (kN) | Shear lb (kN) |
| 3/8 | 2,185 (9.7) | 1,125 (5.0) | 2,640 (11.7) | 1,360 (6.0) | 2,115 (9.4) | 1,090 (4.8) | 2,730 (12.1) | 1,410 (6.3) | 4,555 (20.3) | 2,345 (10.4) | 3,645 (16.2) | 1,875 (8.3) |
| 1/2 | 3,885 (17.3) | 2,000 (8.9) | 4,695 (20.9) | 2,420 (10.8) | 3,755 (16.7) | 1,935 (8.6) | 4,860 (21.6) | 2,505 (11.1) | 8,095 (36.0) | 4,170 (18.5) | 6,480 (28.8) | 3,335 (14.8) |
| 5/8 | 6,075 (27.0) | 3,130 (13.9) | 7,340 (32.6) | 3,780 (16.8) | 5,870 (26.1) | 3,025 (13.5) | 7,595 (33.8) | 3,910 (17.4) | 12,655 (56.3) | 6,520 (29.0) | 10,125 (45.0) | 5,215 (23.2) |
| 3/4 | 8,750 (38.9) | 4,505 (20.0) | 10,570 (47.0) | 5,445 (24.2) | 8,455 (37.6) | 4,355 (19.4) | 10,935 (48.6) | 5,635 (25.1) | 18,225 (81.1) | 9,390 (41.8) | 12,390 (55.1) | 6,385 (28.4) |

For SI: 1 lbf = 4.45 N.

¹ Steel strength as defined in AISC Manual of Steel Construction (ASD):
Tensile = 0.33 x F_u x Nominal Area
Shear = 0.17 x F_u x Nominal Area

² 3/8-inch dia. threaded rods are not included in the ASTM F1554 standard. Values are provided in the table for illustration purposes only based on the nominal area of the 3/8-inch rod and ASTM F1554 ultimate steel strength.

Figure 2 — Allowable anchor installation locations in the face of grout-filled masonry construction

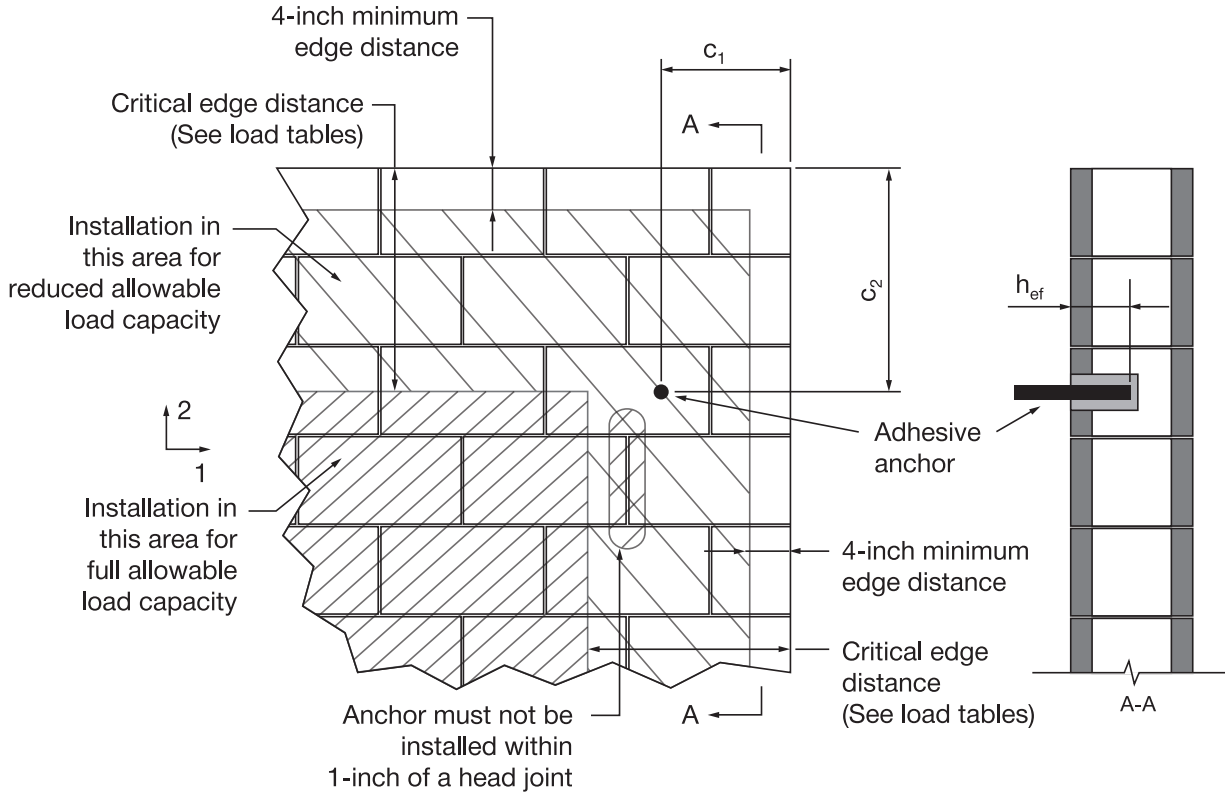
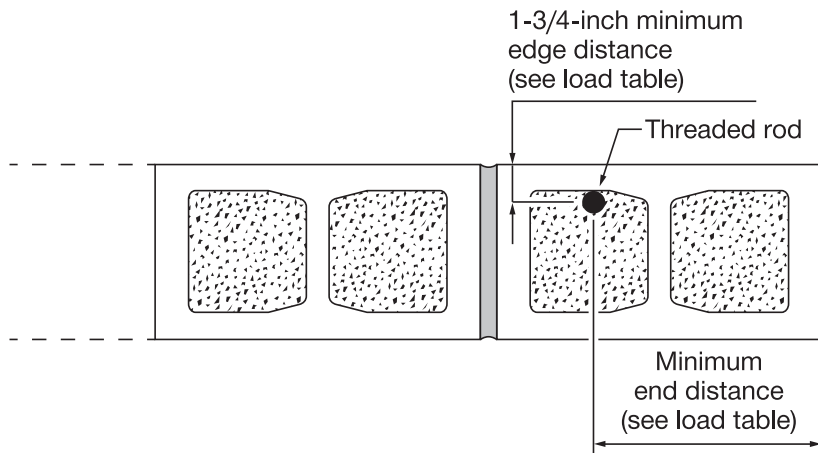

Figure 3 — Allowable anchor installation locations in the top of grout-filled masonry construction



MATERIAL SPECIFICATIONS

Material specifications for Hilti HAS threaded rods, Hilti HIT-Z anchor rods, and Hilti HIS-N inserts are listed in section 3.2.8 (PTG Vol 2 Ed. 17).

Table 65 — Material properties for cured HIT-HY 100 adhesive

| | | |
|---|-------------------------------|----------------------------------|
| Compressive Strength ASTM C579 | > 50 MPa | > 7252 psi |
| Flexural Strength ASTM C 580 | > 20 MPa | > 2900 psi |
| Modulus of Elasticity ASTM C 307 | > 3500 MPa | > 5.07 x 10 ⁵ psi |
| Water Asorption ASTM D 570 | < 2% | |
| Electrical Resistance DIN/VDE 0303T3 | ~ 2 x 10 ¹¹ OHM/cm | ~ 5.1 x 10 ¹¹ OHM/in. |

For material specifications for anchor rods and inserts, please refer to section 3.2.8 of the Hilti North American Technical Guide Volume 2: Anchor Fastening Technical Guide

Table 67 — Gel Time ^{1,2}

| Base material temperature | | HIT-HY 100 |
|---------------------------|-----|------------|
| °F | °C | |
| 14 | -10 | 3 h |
| 23 | -4 | 40 min |
| 32 | 1 | 20 min |
| 41 | 6 | 8 min |
| 51 | 11 | 8 min |
| 69 | 21 | 5 min |
| 87 | 31 | 2 min |

Table 68 — Full Cure Time ^{1,2}

| Base material temperature | | HIT-HY 100 |
|---------------------------|-----|------------|
| °F | °C | |
| 14 | -10 | 12 h |
| 23 | -4 | 4 h |
| 32 | 1 | 2 h |
| 41 | 6 | 60 min |
| 51 | 11 | 60 min |
| 69 | 21 | 30 min |
| 87 | 31 | 30 min |

¹ Product temperatures must be maintained above 41°F (5°C) prior to installation.
² Gel times and full cure times are approximate.

Table 66 — Resistance of HIT- HY 100 to chemicals

| Chemical | | Behavior |
|---------------------------|------------------------------------|----------|
| Sulphuric acid | conc. | - |
| | 30% | • |
| | 10% | + |
| Hydrochloric acid | conc. | • |
| | 10% | + |
| Nitric acid | conc. | - |
| | 10% | • |
| Phosphoric acid | conc. | + |
| | 10% | + |
| Acetic acid | conc. | • |
| | 10% | + |
| Formic acid | conc. | - |
| | 10% | • |
| Lactic acid | conc. | + |
| | 10% | + |
| Citric acid | 10% | + |
| | Sodium Hydroxide (Caustic soda) | 40% |
| 20% | | + |
| 5% | | + |
| Amonia | conc. | • |
| | 5% | + |
| Soda solution | 10% | + |
| Common salt solution | 10% | + |
| Chlorinated lime solution | 10% | + |
| Sodium hypochlorite | 2% | + |
| Hydrogen peroxide | 10% | + |
| Carbolic acid solution | 10% | - |
| Ethanol | | - |
| Sea water | | + |
| Glycol | | + |
| Acetone | | - |
| Carbon tetrachloride | | - |
| Toluene | | + |
| Petrol/Gasoline | | • |
| Machine Oil | | • |
| Diesel oil | | • |

Key: - non resistant + resistant • limited resistance

INSTALLATION INSTRUCTIONS

Installation Instructions For Use (IFU) are included with each product package. They can also be viewed or downloaded online at www.hilti.com (US), or www.hilti.ca (Canada). Because of the possibility of changes, always verify that downloaded IFU are current when used. Proper installation is critical to achieve full performance. Training is available on request. Contact Hilti Technical Services for applications and conditions not addressed in the IFU.



In the US:

Hilti, Inc. (U.S.)
7250 Dallas Parkway, Suite 1000, Dallas, TX 75024
Customer Service: 1-800-879-8000
en español: 1-800-879-5000
Fax: 1-800-879-7000

www.hilti.com

Hilti is an equal opportunity employer.
Hilti is a registered trademark of Hilti, Corp.
©Copyright 2018 by Hilti, Inc. (U.S.)

In Canada:

Hilti (Canada) Corporation
2360 Meadowpine Blvd.
Mississauga, Ontario, L5N 6S2
Customer Service: 1-800-363-4458
Fax: 1-800-363-4459

www.hilti.ca



*14001 US only

The data contained in this literature was current as of the date of publication. Updates and changes may be made based on later testing. If verification is needed that the data is still current, please contact the Hilti Technical Support Specialists at 1-800-879-8000. All published load values contained in this literature represent the results of testing by Hilti or test organizations. Local base materials were used. Because of variations in materials, on-site testing is necessary to determine performance at any specific site. Laser beams represented by red lines in this publication. Printed in the United States