



DIVISION: 04 00 00—MASONRY
Section: 04 05 19.16—Masonry Anchors

REPORT HOLDER:

HILTI, INC.

EVALUATION SUBJECT:

HILTI HIT-HY 270 ADHESIVE ANCHOR SYSTEM IN UNREINFORCED MASONRY

1.0 EVALUATION SCOPE

Compliance with the following codes:

- 2021, 2018, and 2015 *International Building Code*® (IBC)
- 2021, 2018, and 2015 *International Residential Code*® (IRC)
- 2021, 2018, and 2015 *International Existing Building Code*® (IEBC)

For evaluation for compliance with codes adopted by the Los Angeles Department of Building Safety (LADBS), see [ESR-4144 LABC, LARC and LAEBC supplement](#).

Property evaluated:

Structural

2.0 USES

The Hilti HIT-HY 270 Adhesive Anchor System is used to anchor threaded steel rods or deformed steel reinforcement bars in unreinforced brick masonry. Anchors installed in unreinforced masonry with the HIT-HY 270 adhesive system are designed to resist short-term loads imposed by earthquake or wind, as noted in Section 4.0 of this report. The anchor system is an alternative to anchors described in Section 8.1.3 of TMS 402 (2016 or 2013 editions) as referenced in Section 2107 of the 2021, 2018, and 2015 IBC, respectively, as applicable. The anchors are an alternative to bolts described in Section A107.4 and Section A113.1 of the IEBC. The anchor system may also be used where an engineered design is submitted in accordance with Section R301.1.3 of the IRC.

3.0 DESCRIPTION

3.1 General:

The Hilti HIT-HY 270 Adhesive Anchor System consists of steel threaded rods or reinforcing bars, plastic mesh screen tube(s), the adhesive, and installation equipment as described in this report.

3.2 Materials:

3.2.1 Hilti HIT-HY 270 Adhesive: The Hilti HIT-HY 270 adhesive is an injectable hybrid adhesive mortar consisting of urethane methacrylate resin, hardener, cement and water. The resin and cement are separated from the hardener and water by means of a dual-cylinder foil pack attached to a manifold. An injection nozzle with an internal mixing element is attached to the manifold, and the adhesive components are dispensed through the injection nozzle to ensure proper mixing of the separate adhesive components. The injection nozzle may be replaced to permit multiple uses of the foil packs. Available foil pack sizes include total mixed volumes of 11.1 ounces (330 mL) and 16.9 ounces (500 mL).

The adhesive expiration date is printed on the manifold of each foil pack (month/year). The shelf life, as indicated by the expiration date, is for an unopened foil pack stored in a cool, dry, dark environment at temperatures between 41°F and 77°F (5°C and 25°C). Gel and curing times for the Hilti HIT-HY 270 adhesive and the respective masonry temperature during installation and cure are shown in Table 1.

3.2.2 Threaded Steel Rods and Reinforcing Bars: The threaded steel rods are ³/₄ inch (19.1 mm) in diameter, and must comply with the minimum mechanical properties of ASTM A307. Alternatively, the ³/₄-inch threaded rods may be used in a prebent 22¹/₂-degree configuration. Threaded rods are supplied with nuts conforming to ASTM A563, Grade A, hex style, and with washers conforming to ANSI B 18.22.1, type A, Plain. The steel reinforcing bars are No. 4, No. 5, or No. 6 deformed bars complying with ASTM A615, A706, A767, or A996, Grade 60.

3.2.3 Plastic Mesh Screen Tubes: The mesh screen tubes are plastic with a black driving collar at the open end. They are available in diameters and lengths as described in Section 4.1. Different lengths can be achieved by assembling multiple screen tubes together, as depicted in Figure 3.

3.3 Unreinforced Masonry:

The existing unreinforced masonry walls must have a minimum nominal thickness of 13 inches (330 mm) [three wythes of brick]. The average in-place mortar shear strength of the building's unreinforced masonry determined in accordance with Section A106.2.3 (2021 and 2018 IEBC) or A106.3.3 (2015 IEBC), as applicable, must be no less than 50 psi (345 kPa) net.

4.0 DESIGN AND INSTALLATION

4.1 General:

Two types of anchor assemblies are available: Configuration A (shear anchor or rebar dowel) and Configuration B (22¹/₂-degree combination anchor).

4.1.1 Configuration A, Threaded Rods or Steel Reinforcing Bars in Shear (Shear Anchor or Rebar Dowel): Configuration A is the anchor assembly resisting shear loads only. Configuration A consists of a ³/₄-inch-diameter (19.1 mm), ASTM A307 threaded rod or a No. 4, No. 5 or No. 6 reinforcing bar and a 1-inch-diameter-by-8-inch-long (26 mm by 200 mm) plastic-mesh screen tube (HIT-SC 26x200). Figure 1 shows details of an installed shear-resisting assembly.

4.1.2 Configuration B, Bent Threaded Rods in Shear and Tension (22¹/₂-degree Combination Anchor): Configuration B is the anchor assembly resisting a combination of tension and shear loads. Configuration B consists of a ³/₄-inch-diameter (19.1 mm), ASTM A307 threaded rod prebent at an angle of 22¹/₂ degrees and a 1-inch-diameter-by-13-inch-long (26 mm by 325 mm) plastic-mesh screen tube obtained by combining 1-inch-diameter-by-8-inch-long (26 mm by 200 mm) and 1-inch-diameter-by-5-inch-long (26 mm by 125 mm) plastic-mesh screen tubes (HIT-SC 26x200 and HIT-SC 26x125). The anchor must be embedded a minimum of 13 inches (330 mm) at a downward angle of 22¹/₂ degrees to the horizontal. Figure 2 shows details of an installed shear- and tension-resisting assembly.

4.2 Design:

The Hilti HIT-HY 270 adhesive anchors are intended to resist only short-term loads imposed by wind or earthquake. The anchors must be approved by a registered design professional and installed under special inspection in accordance with Section 4.5 of this report. The edge distance and vertical and horizontal spacing for the two types of anchor assemblies described in Section 4.1 must comply with Table 2.

Conditions of acceptance for threaded rods and reinforcing bars in unreinforced brick masonry are as follows:

4.2.1 Configuration A, Threaded Rods or Steel Reinforcing Bars in Shear (Shear Anchor or Rebar Dowel):

- Installation of assemblies using threaded rods or reinforcing bars intended to resist shear loads only must comply with Sections 4.1 and 4.3, and Figure 3 of this report.
- The allowable shear load for the ³/₄-inch-diameter (19.1 mm) threaded rod is 1,000 pounds (4450 N), as shown in Table 3. The allowable shear loads for the No. 4, No. 5, and No. 6 reinforcing bars are 500, 750, and 1,000 pounds (2225, 3338, and 4450 N), respectively, as shown in Table 3. No adjustment for wind or earthquake loading is permitted.
- The allowable shear loads noted above are applicable only to anchors installed in walls where in-place shear tests indicate a minimum mortar strength of 50 psi (345 kPa) net in accordance with Section A106.2.3 (2021 and 2018 IEBC) or A106.3.3 (2015 IEBC), as applicable.

4.2.2 Configuration B, Bent Threaded Rods in Shear and Tension (22¹/₂-degree Combination Anchor):

- Installation of assemblies using prebent threaded rods intended to resist a combination of tension and shear

loads must comply with Sections 4.1 and 4.3, and Figure 3 of this report.

- The maximum allowable tension load for the ³/₄-inch-diameter (19.1 mm) prebent threaded rod (Configuration B) is 1,200 pounds (5340 N), as shown in Table 3. No adjustment for wind or earthquake loading is permitted.
- The maximum allowable shear load for the ³/₄-inch-diameter (19.1 mm) prebent threaded rod (Configuration B) is 1,000 pounds (4,450 N), as shown in Table 3. No adjustment for wind or earthquake loading is permitted.
- The maximum allowable load for the bent rod anchors subjected to combined tension and shear loads is determined by the following equation:

$$\left(\frac{P_s}{P_t}\right) + \left(\frac{V_s}{V_t}\right) \leq 1.0$$

where:

P_s = Applied tension load

P_t = Allowable tension load

V_s = Applied shear load

V_t = Allowable shear load

- The allowable tension and shear values as determined above are applicable only to anchors installed in walls where in-place shear tests indicate minimum mortar strength of 50 psi (345 kPa) net in accordance with Section A106.2.3 (2021 and 2018 IEBC) or A106.3.3 (2015 IEBC), as applicable

4.3 Installation:

4.3.1 General: 1-inch-diameter (25.4 mm) holes must be drilled using standard carbide-tipped masonry drill bits complying with ANSI Specification B212.15-1994, or diamond core drill bits, as detailed in Figure 3 of this report. Holes must be drilled using a rotary drill or a rotary hammer drill set on "rotation only", or core drill, as applicable. Impact tools are not permitted. Assembly installation must be in accordance with Section 4.3.2 or 4.3.3, and Figure 3 of this report. The adhesive must be allowed to cure for the full curing time listed in Table 1 before anchors are loaded. Cure time refers to that period of cure after which hardware may be placed and nuts tightened. Design loads may not be applied until the full curing time has transpired. Installation must not occur when masonry temperatures are below 41 °F (5 °C). The Hilti HIT HY 270 Adhesive Anchor System is intended to resist only short-term loads imposed by wind or earthquake. The anchors must be approved by the registered professional and installed under special inspection in accordance with Section 4.5 of this report. The edge distance, and vertical and horizontal spacing for all anchor configurations described in Sections 4.3.2 and 4.3.3 of this report, must comply with Table 2.

4.3.2 Configuration A: Holes for threaded rods or reinforcing bars intended to resist shear only must be drilled perpendicular to the wall to a minimum embedment depth of 8 inches (203 mm). The holes must be cleaned in accordance with Figure 3 of this report to remove debris. The Hilti HIT-HY 270 adhesive must be injected into the supplied plastic mesh screen tube that is then inserted into the predrilled hole. The threaded rod or reinforcing bar must be inserted and pushed into the screen tube in a rotating manner to force the adhesive into the hole. Figure 1 illustrates an anchor installed in this configuration. Figure 3 illustrates the Manufacturer's Published Installation Instructions (MPII).

4.3.3 Configuration B: Holes for installation of assemblies using prebent threaded rods intended to resist shear and tension must be drilled at a 22¹/₂-degree angle to within 1 inch (25.4 mm) of the opposing surface. The holes must be cleaned in accordance with Figure 3 of this report to remove debris. The Hilti HIT-HY 270 adhesive must be injected into the supplied plastic mesh screen tube that is then inserted into the predrilled hole. The prebent threaded rod must be inserted and pushed into the screen tube in a rotating manner to force the adhesive into the hole. Figure 2 illustrates an anchor installed in this configuration. Figure 3 illustrates the MPII.

4.4 Field Tests:

- a. Tests for in-place mortar shear strength of the building must be done in accordance with Section A106.2.3 (2021 and 2018 IEBC) or A106.3.3 (2015 IEBC), as applicable. In-place mortar shear strength testing must indicate a minimum mortar strength of 50 psi (345 kPa).
- b. Anchors resisting tension forces or a combination of tension and shear forces must be tested in accordance with Section A107.5 of the IEBC. The test report must include:
 1. Test location(s)
 2. Brick/mortar condition
 3. Bolt movement/elongation
 4. Embedment depth and masonry wall thickness
 5. Applied load, loading procedure, load increments, and rate of loading.

4.5 Special Inspection:

4.5.1 IBC and IRC: Continuous special inspection must be performed in accordance with Sections 1704 and 1705 of the IBC.

4.5.2 IEBC: Periodic inspection, direct-tension tests, and calibrated torque wrench tests must be performed in accordance with Section A107.5 of the IEBC. In lieu of testing and periodic inspection, the IEBC permits continuous special inspection during installation of bolts resisting shear forces only.

5.0 CONDITIONS OF USE

The Hilti HIT-HY 270 Adhesive Anchoring System for Unreinforced Masonry described in this report complies with, or is a suitable alternative to what is specified in, those codes listed in Section 1.0 of this report, subject to the following conditions:

- 5.1 Use and installation must be as set forth in this evaluation report and the Manufacturer's Published Installation Instructions (MPII) illustrated in Figure 3 of this report. In case of conflict, this report governs.
- 5.2 Calculations and details must be submitted to the code official for approval.
- 5.3 Special inspection must be in accordance with Section 4.5 of this evaluation report.

5.4 Use of the anchor system must be approved by the registered design professional.

5.5 The existing mortar shall have a minimum in-place shear strength of 50 psi (345 kPa) in accordance with Section 3.3 of this report prior to installation of the adhesive anchors.

5.6 Anchors must be limited to resisting transient wind or seismic loads only.

5.7 Anchors are installed in holes predrilled with a carbide-tipped masonry drill bit complying with ANSI B212.15-1994, or diamond core drill bits, in accordance with Figure 3 of this report. Impact tools must not be used for drilling holes or for tightening steel anchors or nuts.

5.8 The adhesive is not used after the expiration date stamped on the cartridge.

5.9 The Hilti HIT-HY 270 adhesive is manufactured by Hilti GmbH in Kaufering, Germany, under a quality control program with inspections by ICC-ES.

5.10 The Hilti HIT-SC screens are manufactured by Herbert Kaut GmbH & Co. KG in Sigmaringen, Germany, under a quality-control program with inspections by ICC-ES.

6.0 EVIDENCE SUBMITTED

Data in accordance with the ICC-ES Acceptance Criteria for Adhesive Anchors in Unreinforced Masonry Elements (AC60), dated December 2009 (editorially revised March 2021); and quality-control documentation.

7.0 IDENTIFICATION

7.1 The ICC-ES mark of conformity, electronic labeling, or the evaluation report number (ICC-ES ESR-4144) along with the name, registered trademark, or registered logo of the report holder must be included in the product label.

7.2 In addition, Hilti HIT-HY 270 adhesive cartridges are identified by a label displaying the product name, lot number, expiration date, a description of the product, and installation instructions. The Hilti HIT-SC screens are identified by a label displaying the product name, lot number, a description of the product, and installation instructions. Threaded rods, nuts, washers, and deformed reinforcing bars are standard elements and must conform to applicable national or international specifications.

7.3 The report holder's contact information is the following:

HILTI, INC.
7250 DALLAS PARKWAY, SUITE 1000
PLANO, TEXAS 75024
(800) 879-8000
www.us.hilti.com
HiltiTechEng@us.hilti.com

TABLE 1—HILTI'S GEL AND CURING TIMES FOR HILTI HIT-HY 270 ADHESIVE

MINIMUM BASE MATERIAL TEMPERATURE ¹		GEL TIME ²	CURING TIME ³
°F	°C		
41	5	10 minutes	4 hours
42-50	6-10	7 minutes	2.5 hours
51-68	11-20	4 minutes	1.5 hours
69-86	21-30	2 minutes	30 minutes
87-104	31-40	1 minute	20 minutes

For SI: °C = $\frac{5}{9}(\text{°F} - 32)$.

¹The temperatures listed above refer to the base-material temperature, not ambient air temperature.

²The anchors may be adjusted during the gel time following installation.

³Anchors must not be disturbed between gel time and curing time. The anchors may be loaded after the full curing time has elapsed.

TABLE 2—SPACING AND EDGE DISTANCE REQUIREMENTS FOR HILTI HIT-HY 270 ADHESIVE INSTALLED IN UNREINFORCED BRICK MASONRY

ANCHOR ASSEMBLY	MINIMUM VERTICAL SPACING (inches)	MINIMUM HORIZONTAL SPACING (inches)	MINIMUM EDGE DISTANCE (inches)
Configuration A, Threaded Rods or Reinforcing Bars in Shear (see Figure 1)	16	16	16
Configuration B, Bent Threaded Rods in Shear and Tension (22 $\frac{1}{2}$ ° Combination Anchor) (see Figure 2)	16	16	16

For SI: 1 inch = 25.4 mm.

TABLE 3—ALLOWABLE TENSION AND SHEAR LOADS FOR THREADED RODS AND REINFORCING BARS FOR HILTI HIT-HY 270 ADHESIVE INSTALLED IN UNREINFORCED BRICK MASONRY^{1,2}

CONFIGURATION A – SHEAR ANCHOR OR REBAR DOWEL (FIGURE 1)				
Threaded Rod Dia. (inch) or Rebar Size	Minimum Embedment (inches)	Minimum Wall Thickness (inches)	Allowable Tension Load (pounds)	Allowable Shear Load (pounds)
$\frac{3}{4}$	8	13	-	1,000
No. 4	8	13	-	500
No. 5	8	13	-	750
No. 6	8	13	-	1,000
CONFIGURATION B – 22 $\frac{1}{2}$ ° COMBINATION ANCHOR (FIGURE 2)				
Threaded Rod Dia. (inch)	Minimum Embedment	Minimum Wall Thickness (inches)	Allowable Tension Load ³ (pounds)	Allowable Shear Load (pounds)
$\frac{3}{4}$	Within 1 inch of opposite wall surface	13	1,200	1,000

For SI: 1 inch = 25.4 mm, 1 lbf = 4.45 N, 1 foot-pound = 1.356 N-m, 1 psi = 6.89 Pa.

¹Allowable load values are applicable only to anchors where in-place shear tests indicate minimum mortar strength of 50 psi, net.

²No increase for short-term loading is permitted, such as loading induced by wind or earthquake.

³Anchors must be tested in accordance with Section 4.4 for use with the IEBC.

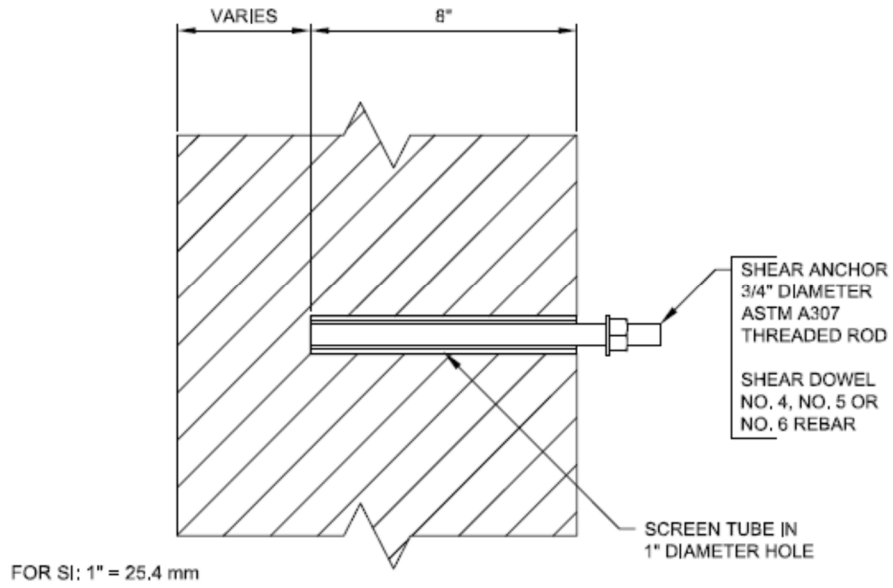

FIGURE 1—HILTI HIT-HY 270 ADHESIVE SHEAR ANCHOR OR DOWEL (CONFIGURATON A)

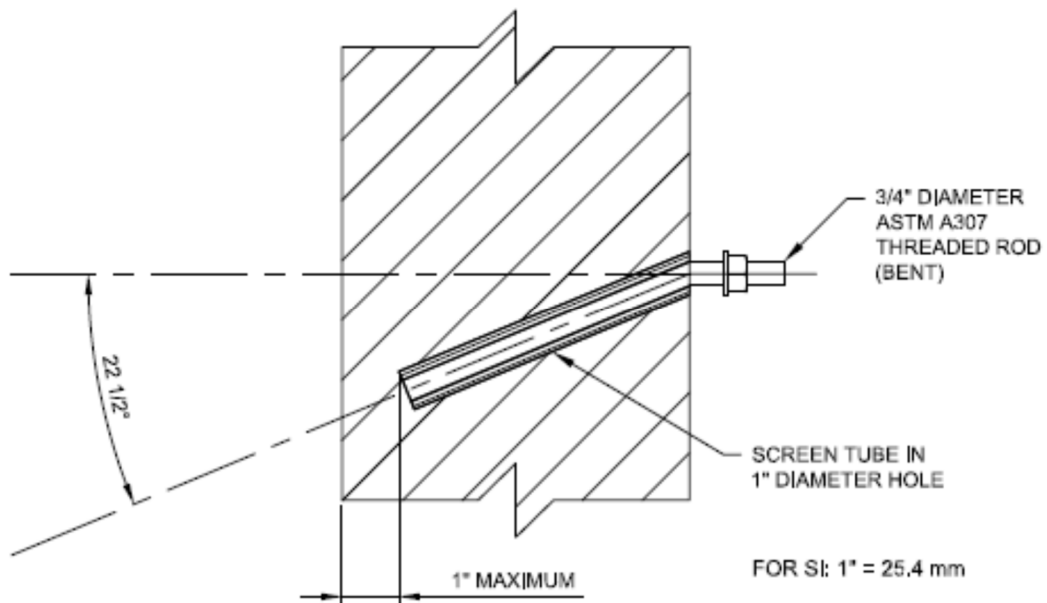

FIGURE 2—HILTI HIT-HY 270 ADHESIVE 22¹/₂° COMBINATION ANCHOR (CONFIGURATION B)

HILTI



Hilti HIT-HY 270

Instruction for use en
 Mode d'emploi fr
 Manual de instrucciones es
 Instruções de utilização pt



Danger

(A, B) (A) (B)

Contains: methacrylates (A), dibenzoyl peroxide (B), boric acid (A), 4-tert-butylpyrocatechol (A)

May cause an allergic skin reaction. (A,B)
 Causes serious eye irritation. (A)
 May damage fertility or the unborn child. (A)
 Very toxic to aquatic life with long lasting effects. (B)
 Harmful to aquatic life with long lasting effects. (A)



ICC ESR - 4143
ICC ESR - 4144

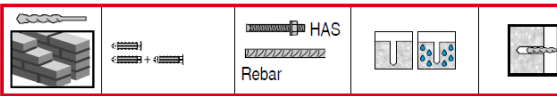



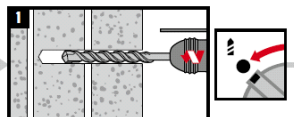

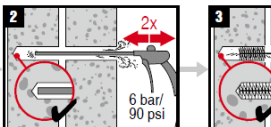

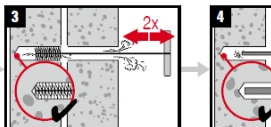

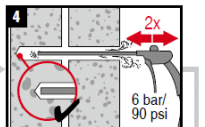

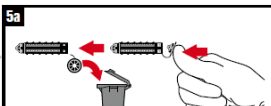

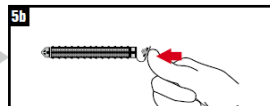

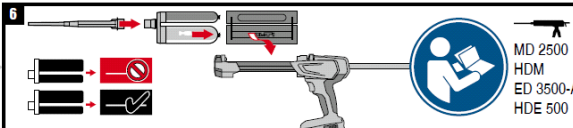



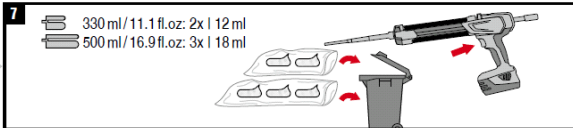

MD 2500
HDM
ED 3500-A
HDE 500



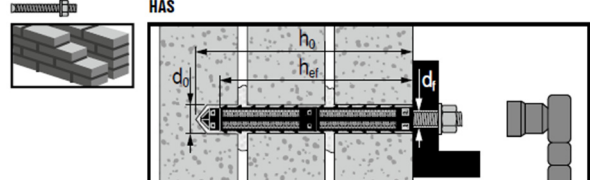

330 ml / 11.1 fl.oz.: 2x | 12 ml
 500 ml / 16.9 fl.oz.: 3x | 18 ml

Drilling with hammer drill and carbide tipped hammer drill bit

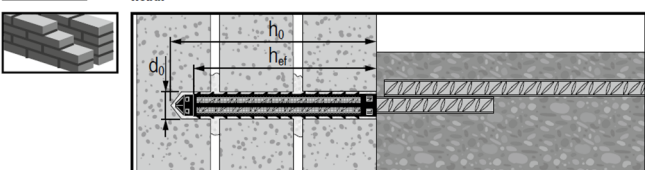

HAS	HIT-SC	d_0 [inch]	h_0 [inch]	h_{ef} [inch]	HIT-RB	d_f [inch]	T_{inst} [ft lb]
		1	8 1/4	8		13/16	≤ 60
			13 1/4	13			
			26x200	26x200			



Rebar	HIT-SC	d_0 [inch]	h_0 [inch]	h_{ef} [inch]	HIT-RB
#4		1	8 1/4	8	
#5					
#6					

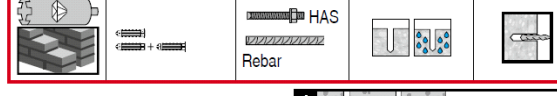



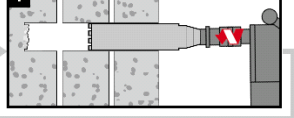

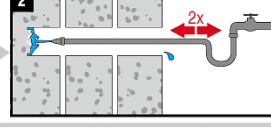

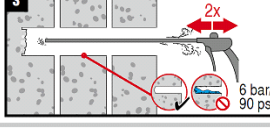

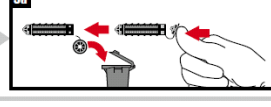

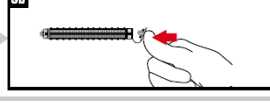

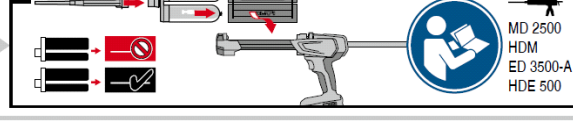

MD 2500
HDM
ED 3500-A
HDE 500

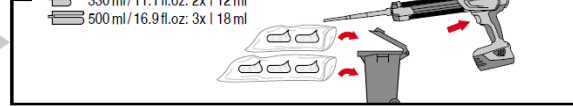

330 ml / 11.1 fl.oz.: 2x | 12 ml
 500 ml / 16.9 fl.oz.: 3x | 18 ml

Drilling with diamond core bit

FIGURE 3—HILTI HIT-HY 270 ADHESIVE MANUFACTURER'S PUBLISHED INSTALLATION INSTRUCTIONS (MPII)

Hilti HIT-HY 270

Hilti HIT-HY 27

Adhesive anchoring system for rebar and anchor fastenings.

For use in hollow and solid masonry of clay brick, concrete block and multi wythe wall.

Hilti HIT-HY 270
Contains: methacrylates, dibenzoyl peroxide, boric acid

Danger

H315	Causes skin irritation.(A)
H317	May cause an allergic skin reaction.(A,B)
H319	Causes serious eye irritation.(A)
H360	May damage fertility or the unborn child.(A)
H400	Very toxic to aquatic life (B)
H412	Harmful to aquatic life with long lasting effects.(A)
P262	Do not get in eyes, on skin, or on clothing.
P280	Wear protective gloves/protective clothing/eye protection/face protection.
P302+P352	IF ON SKIN: Wash with plenty of soap and water.
P305+P351+P338	IF IN EYES: Rinse cautiously with water for several minutes. Remove contact lenses, if present and easy to do. Continue rinsing.
P333+P313	If skin irritation or rash occurs: Get medical advice/attention.
P337+P313	If eye irritation persists: Get medical advice/attention.

Disposal considerations

Empty packs:
 ▶ Leave the mixer attached and dispose of via the local Green Dot recovery system or EAK waste material code: 150102 plastic packaging

Full or partially emptied packs:

▶ Must be disposed of as special waste in accordance with official regulations.
 EAK waste material code: 08 04 09* waste adhesives and sealants containing organic solvents or other dangerous substances, or EAK waste material code: 20 01 27* paint, inks, adhesives and resins containing dangerous substances.

Warranty: Refer to standard Hilti terms and conditions of sale for warranty information.

Failure to observe these installation instructions, use of non-Hilti anchors, poor or questionable base material conditions, or unique applications may affect the reliability or performance of the fastenings.

Content: 11.1 fl.oz. / 330 ml 16.9 fl. oz / 500 ml
Weight: 20.8 oz / 590 g 28.9 oz / 820 g

Product Information

- Always keep these instructions together with the product even when given to other persons.
- Check expiration date: See imprint on foil pack manifold (month/year). Do not use expired product.
- Foil pack temperature during usage: between 41 °F and 104 °F / +5 °C and 40 °C.
- Base material temperature at time of installation: between 23 °F and 104 °F / -5 °C and 40 °C.
- **Exception in hollow, solid and multi-wythe solid clay brick:** between 41°F and 104°F / +5°C and 40°C.
- Conditions for transport and storage: Keep in a cool, dry and dark place between 41 °F and 77 °F / 5°C and 25°C.
- For any application not covered by this document / beyond values specified, please contact Hilti.
- Partly used foil packs must remain in the cassette and has to be used within 4 weeks. Leave the mixer attached on the foil pack manifold and store within the cassette under the recommended storage conditions. If reused, attach a new mixer and discard the initial quantity of anchor adhesive.

NOTICE

- ▲ **Improper handling may cause mortar splashes.**
 - Always wear safety glasses, gloves and protective clothes during installation.
 - Never start dispensing without a mixer properly screwed on.
 - Attach a new mixer prior to dispensing a new foil pack (ensure snug fit).
 - Use only the type of mixer (HIT-RE-M) supplied with the adhesive. Do not modify the mixer in any way.
 - Never use damaged foil packs and/or damaged or unclean foil pack holders (cassettes).
- ▲ **Poor load values / potential failure of fastening points due to inadequate borehole cleaning.**
 - The boreholes must be free of debris, dust, water, ice, oil, grease and other contaminants prior to adhesive injection.
 - For blowing out the borehole – blow out with oil free air until return air stream is free of noticeable dust.
 - For brushing the borehole – only use specified wire brush. The brush must resist insertion into the borehole – if not the brush is too small and must be replaced.
- ▲ **Borehole filling in solid masonry:** Ensure that boreholes are filled from the back of the borehole without forming air voids. If necessary use the accessories / extensions to reach the back of the borehole.
- ▲ **Borehole filling in hollow masonry:** Use a mesh sleeve. Fill the mesh sleeve with mortar from the centering cap until mortar escapes at the centering cap (filling control).
- ▲ **Multi-Wythe Solid Brick application: HIT-SC sieve sleeves / sieve sleeve combinations have to be filled outside the bore hole:** Push the mixer to the bottom of the last mesh sleeve (use mixer extension if necessary). Inject the anchor adhesive starting at the bottom of the last mesh sleeve while slowly withdrawing the mixing nozzle towards the centering cap, step by step, after each pull of the trigger. HIT-SC sieve sleeves have to be filled completely without forming air voids until anchor adhesive escapes at the centering cap (filling control).
- ▲ **Not adhering to these setting instructions can result in failure of fastening points!**

FIGURE 3—HILTI HIT-HY 270 ADHESIVE MANUFACTURER’S PUBLISHED INSTALLATION INSTRUCTIONS (MPII) (Continued)

DIVISION: 04 00 00—MASONRY
Section: 04 05 19.16—Masonry Anchors

REPORT HOLDER:

HILTI, INC.

EVALUATION SUBJECT:

HILTI HIT-HY 270 ADHESIVE ANCHOR SYSTEM IN UNREINFORCED MASONRY

1.0 REPORT PURPOSE AND SCOPE

Purpose:

The purpose of this evaluation report supplement is to indicate that the Hilti HIT-HY 270 Adhesive Anchor System in unreinforced masonry, described in ICC-ES evaluation report [ESR-4144](#), has also been evaluated for compliance with the codes noted below as adopted by the Los Angeles Department of Building and Safety (LADBS).

Applicable code editions:

- 2020 *City of Los Angeles Building Code* (LABC)
- 2020 *City of Los Angeles Residential Code* (LARC)
- 2020 *City of Los Angeles Existing Building Code* (LAEBC)

2.0 CONCLUSIONS

The Hilti HIT-HY 270 Adhesive Anchor System in unreinforced masonry, described in Sections 2.0 through 7.0 of the evaluation report [ESR-4144](#), complies with the LABC Chapters 21 and 88, LAEBC Appendix A Chapter A1, and the LARC, and is subject to the conditions of use described in this supplement.

3.0 CONDITIONS OF USE

The Hilti HIT-HY 270 Adhesive Anchor System in unreinforced masonry described in this evaluation report supplement must comply with all of the following conditions:

- All applicable sections in the r evaluation report [ESR-4144](#).
- The design, installation, conditions of use and identification of the anchors are in accordance with the 2018 *International Building Code*® (2018 IBC) and the 2018 *International Existing Building Code*® (2018 IEBC) provisions noted in the evaluation report [ESR-4144](#).
- The design, installation, testing and inspection are in accordance with additional requirements of LABC Chapters 16, 17, 21, 88, and LAEBC Appendix Chapter A1, as applicable, including LABC Sections 1704, 1705, 2107, and LAEBC Sections A106, A107, and A108.
- Under the LARC, an engineered design in accordance with LARC Section R301.1.3 and additional requirements noted in this supplement must be submitted.
- The allowable load values listed in the evaluation report and tables are for the connection of the adhesive anchors to the unreinforced masonry. The connection between the adhesive anchors and the connected members must be checked for capacity (which may govern).

This supplement expires concurrently with the evaluation report, reissued August 2022 and revised April 2023.