

# Anchor Systems

Hilti. Outperform. Outlast.





**Injectable Adhesive Anchors**

Injectable mortar HIT-RE 500-SD, HIT-RE 500, HIT-HY 200-R	Page 238-239
Anchor rod (metric) Hilti HIT-Z, (stainless metric) Hilti HIT-Z-R, Hammer drill bit TE-YD, TE-CD	Page 239-241
Injectable mortar HIT-HY 110, HIT-CT 1, HIT-HY 70, HIT-MM PLUS	Page 242-243



**Anchor Rods and Elements**

Adhesive anchor system HVU-TZ, Anchor rod HAS-TZ, HAS-RTZ	Page 247-248
Foil capsule adhesive anchor HVU	Page 249
Anchor rod HAS-E, HAS-E-F, HAS-E-R, HAS-E-HCR	Page 250-252
Internal threaded sleeve (metric) HIS-N, (metric stainless) HIS-RN	Page 253
Anchor rod HIT-V-5.8, HIT-V 8.8, HIT-V-F, HIT-V-R	Page 254-256
Meter Anchor rod AM, AM 8.8 HDG	Page 257-258
Composite mesh sleeve HIT-SC and accessories	Page 258



**Dispensers, Accessories, Testers**

HIT Profi accessories for blowing out, cordless and manual dispensers	Page 260
Cartridge holders, mixers, extensions and components	Page 261
Anchor testers, torque bar, setting tools and accessories	Page 261-267



**Undercut Anchors**

Undercut anchors HDA-T, HDA-TF, HDA-TR, HDA-P, HDA-PF, HDA-PR	Page 268-270
Stop drill bit TE-C-HDA-B, TE-Y-HDA-B, Setting tool TE-C-HDA-ST, TE-Y-HDA-ST	Page 271-272
Grinding tool TE-C-HDA-GT, Removal tool TE-C-HDA-RT	Page 272
Safety anchors HSC-A, HSC-AR, HSC-I, HSC-IR, stop drill bit and setting tool	Page 273-275
Undercut anchor system (hot-dip galvanized) HMU-PF, stop drill bit and setting tool	Page 276
Undercutting tool TE-Y-HMU-UC, Dynamic / filling set HDA/HVZ	Page 277



**Expansion Anchors**

Heavy-duty anchor HSL-3, HSL-3-G, HSL-GR, HSL-3-SK	Page 279-281
Stud anchor HST, HST-R, HST-HCR	Page 282-283
Standard stud anchor HSA, HSA-BW, HSA-F, HSA-R2, HSA-R, HSV, HSV-BW	Page 284-288
Machine setting tool for stud anchors HSV/ HSA/ HST/ KB3/ KB-TZ	Page 289
Torque bar S-TB	Page 289



**Flush Anchors**

Drop-in (flush) anchor HKD, setting tools and stop drill bits	Page 290-291
Drop-in anchor HKD-SR, (metric) HKV	Page 292



**Screw Anchors**

Screw anchor HUS3-H 8/10/14, Anchor reusability gauge HRG 8/10/14/16	Page 293
Countersunk carbon steel screw anchor HUS3-C 8/10	Page 294
Screw anchor HUS3-HF 8/10/14, HUS-HR, HUS-CR, HUS-H, HUS-A, HUS-I, HUS-P	Page 294-297
Screw anchor Frame screw anchor HUS-S, Coil anchor HCA, Coil HCT	Page 298-299



**Other Metal Anchors**

Sleeve anchor HLC-H, HLC, HLC-A, HLC-EC, HLC-EO, HLC-T, HLC-SK	Page 300-302
Metal frame anchor HT, Cavity anchor HHD-S, (hex head bolt) HHD-S, Setting tool HHD	Page 302-303
Wedge anchor DBZ, Aerated concrete anchor HPD	Page 304
Sleeve anchor with screw and washer HAM with bolt	Page 304
Hard sleeve anchor HAM without bolt, Hook and ring anchors HA 8	Page 305



**Plastic Anchors**

Frame anchors HRD-C, HRD-CR, HRD-CR2, HRD-H, HRD-HF, HRD-HR, HRD-HR2, HRD-K, HRD-KR2, HRD-P, HRD-PR2	Page 306-311
Impact anchor HPS-1, HPS-1 R, Universal plastic anchor HUD-1, HUD-L	Page 312-314
Gas concrete anchor HGN, Light-duty anchor HLD	Page 315



**Insulation Anchors**

insulation fastener IDMS, IDMR, IDP	Page 316
Insulation fastener and plug IZ, IZ-P, Hilti insulation fastener HIF	Page 316-317



**Cast-In Anchors**

Anchor channel HAC-20, HAC-30, HAC-40, HAC-50, HAC-60, HAC-70	Page 318-322
T-head bolts (galvanized, hdg, stainless) HBC-A, HBC-B, HBC-C 4.6, HBC-C, HBC-C-E, HBC-C-N	Page 323-329



**Rail Anchors**

Anchor rod (rail anchor) HRC, HRT-IP, HRT-I, Sleeve (repair anchor) HRS	Page 330
---	----------

Anchor Systems

## Application overview for chemical anchors

Chemical anchors			
Anchor specification			
	Order description	Highlights	Dimensions
	<b>HIT-RE 500</b> HAS Rod HAS E Rod HIT V Rod Rebar	Large diameter applications, suitable for dry and water saturated concrete and underwater applications, long working time at elevated temperatures, deep embedment depths and suitable for use in diamond drilled holes	<b>M8-M39</b> HIT V, HAS <b>D8-D32</b> Rebar
	<b>HIT-HY 200</b> HIT Z Rod HIT V Rod HIS N Sleeve Rebar	No borehole cleaning required (when used with HIT Z), suitable for dry and water saturated concrete, suitable for use in diamond drilled holes, fast cure	<b>M8-M20</b> HIT Z, HIS N <b>M8-M30</b> HIT V <b>D8-D32</b> Rebar
	<b>HIT-HY 70</b> HIT V Rod HAS Rod HAS E Rod HIT IC Sleeve HIT SC Sleeve	,Specially designed for masonry including clay bricks, sand lime bricks hollow bricks, concrete blocks and natural stone	<b>M6-M12</b> HIT V, HAS, HAS E <b>M8-M12</b> HIT IC, HIT SC
	<b>HIT MM Plus</b> HIT V rod	Suitable for a wide range of base materials including concrete, masonry and concrete blocks	<b>M6-M16</b>
	<b>HVU TZ</b> HAS TZ Rod	Very high loading capacity suitable for dry and water saturated concrete	<b>M10-M20</b>
	<b>HVU</b> HAS Rod HAS E Rod	Very high loading capacity, large diameter applications, suitable for dry and water saturated concrete	<b>M8-M39</b> HAS, HAS E <b>M8-M20</b> HIS



Base material								Installation method		Special features		Corrosion protection			Approvals					
Uncracked concrete	Cracked concrete	Natural stone	Lightweight concrete	Solid brick	Airbrick	Hollowcore	Plasterboard	Through set installation	Pre-set installation	Small edge distance	Data available in PROFIS Anchor 2	Electroplated	Additional protection against corrosion	Stainless steel	Fire	European technical approval	Shock load	Dynamic load	Sprinkler	CE Marking















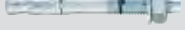

Anchor applications / approvals

Anchor	Uncracked concrete	Cracked concrete	Natural stone	Lightweight concrete	Solid brick	Airbrick	Hollowcore	Plasterboard	Through set installation	Pre-set installation	Small edge distance	Data available in PROFIS Anchor 2	Electroplated	Additional protection against corrosion	Stainless steel	Fire	European technical approval	Shock load	Dynamic load	Ce Marking
Anchor 1	■	■	■						■		■	■	■	■	■					
Anchor 2	■	■							■		■	■	■	■	■					
Anchor 3				■	■	■	■	■	■		■	■	■	■	■					
Anchor 4	■		■	■	■	■			■		■	■	■	■	■					
Anchor 5	■	■							■		■	■	■	■	■					
Anchor 6	■								■		■	■	■	■	■					

Anchor Systems













## Application overview for mechanical anchors

Mechanical anchors			
Anchor specification			
	Order description	Highlights	Dimensions
	<b>HDA</b>	Automatic undercutting with no special tools, setting mark for setting control, completely removable	M10-M20
	<b>HMU</b>	.Undercut alternative to stud anchors for safety-critical applications	M12-M16
	<b>HSL-3</b>	Force controlled expansion, reliable pull down, no rotation in hole when tightening bolt	M8-M24
	<b>HSC</b>	Self cutting undercut, low embedment depth	M6-M12
	<b>HST</b>	Safety wedge for follow up expansion	M8-M24
	<b>HSA</b>	different embedment depths, approved for diamond drilled holes 3	M6-M20
	<b>HSV</b>	.High quality stud anchor for non-specified applications	M8-M16
	<b>HUS3</b>	Reusable anchor available with hexagon and countersink heads. Up to 30% .more load in compassion to stud anchors	mm 14-8
	<b>HUS-6</b>	Quick and easy setting, several head types: hex head, hex head with screw, hex head with socket, pan head	mm 6
	<b>HLC</b>	Available in several head types: hex, bolt, torx, countersunk, eyebolt, ceiling hanger	M5-M16
	<b>HKD</b>	Comes with innovative setting solution for time-effective and reliable installation	M6-M20
	<b>HKV</b>	Setting mark for reliable setting	M6-M16
	<b>DBZ</b>	Reliable setting thanks to simple visual check, performs in tensile zone as redundant fastening only e.g. suspended ceilings	mm 6
	<b>HHD-S</b>	Specially designed for drywall	M4-M8
	<b>HA8</b>	Follow up expansion, performs in tensile zone as redundant fastening only e.g. suspended ceilings	mm 8
	<b>HT</b>	Expansion cone can not be lost	mm 8-10

Base material								Installation method		Special features		Corrosion protection			Approvals					
Uncracked concrete	Cracked concrete	Natural stone	Lightweight concrete	Solid brick	Hollow block	Hollowcore	Plasterboard / Drywall	Through set installation	Pre-set installation	Small edge distance	Data available in calculation software (PROFIS Anchor)	Electroplated	Additional protection against corrosion	Stainless steel	Fire	Shock load	Sprinkler	European technical approval	Dynamic load	CE Marking

Anchor applications / approvals

## Application overview for mechanical anchors

Mechanical anchors			
Anchor specification			
	Order description	Highlights	Dimensions
	<b>HRD</b>	Excellent setting behaviour, versatile with regards base material, finishes and head types; hex, countersunk, pan	,10 ,8 mm 14
	<b>HPS</b>	Impact and temperature resistant	mm 4-8
	<b>HSP</b>	Metal, self cutting, quick setting	M6
	<b>HFP</b>	Plastic, self cutting, quick setting	M6
	<b>HLD</b>	Plastic undercut	mm 10
	<b>GD / GRS</b>	Light scaffolding	mm 14
	<b>ST-127</b>	Heavy scaffolding	M16
	<b>IDMR</b>	Fastening of soft and hard insulation material up to 150 mm, fire rated	mm 8
	<b>IZ</b>	Fastening of soft and hard insulation material up to 180 mm	8 mm
	<b>IDP</b>	Fastening of soft and hard insulation material up to 150 mm	8 mm
	<b>HIF</b>	Fastening of soft insulation material up to 240 mm	8 mm



Base material								Installation method		Special features		Corrosion protection			Approvals			
Uncracked concrete	Cracked concrete	Natural stone	Lightweight concrete	Solid brick	Hollow block	Hollowcore	Plasterboard / Drywall	Through set installation	Pre-set installation	Small edge distance	Data available in calculation software (PROFIS Anchor)	Electroplated	Additional protection against corrosion	Stainless steel				

Anchor applications / approvals

<input checked="" type="checkbox"/>			<input checked="" type="checkbox"/>	<input checked="" type="checkbox"/>	<input checked="" type="checkbox"/>			<input checked="" type="checkbox"/>			<input checked="" type="checkbox"/>	<input checked="" type="checkbox"/>	<input checked="" type="checkbox"/>					
<input checked="" type="checkbox"/>			<input checked="" type="checkbox"/>	<input checked="" type="checkbox"/>	<input checked="" type="checkbox"/>			<input checked="" type="checkbox"/>										
			<input checked="" type="checkbox"/>				<input checked="" type="checkbox"/>		<input checked="" type="checkbox"/>			<input checked="" type="checkbox"/>						
					<input checked="" type="checkbox"/>		<input checked="" type="checkbox"/>		<input checked="" type="checkbox"/>									
<input checked="" type="checkbox"/>									<input checked="" type="checkbox"/>			<input checked="" type="checkbox"/>						
<input checked="" type="checkbox"/>									<input checked="" type="checkbox"/>			<input checked="" type="checkbox"/>						
<input checked="" type="checkbox"/>			<input checked="" type="checkbox"/>	<input checked="" type="checkbox"/>	<input checked="" type="checkbox"/>			<input checked="" type="checkbox"/>					<input checked="" type="checkbox"/>					
<input checked="" type="checkbox"/>			<input checked="" type="checkbox"/>	<input checked="" type="checkbox"/>	<input checked="" type="checkbox"/>			<input checked="" type="checkbox"/>										
<input checked="" type="checkbox"/>			<input checked="" type="checkbox"/>	<input checked="" type="checkbox"/>	<input checked="" type="checkbox"/>			<input checked="" type="checkbox"/>										

Anchor Systems





## Injectable mortar HIT-RE 500-SD



### Key applications and advantages

- Substitution of misplaced / missing rebars or couplers
- Fastenings requiring seismic qualification
- Structural connections with post-installed rebar (e.g. extension/connection to walls, slabs, stairs, columns, foundations, etc.)
- Unique foil packaging and compatible Hilti HIT injection system make handling extremely easy and minimize packaging disposal costs
- European Technical Approval covering automatic cleaning of holes drilled using TE-CD or TE-YD drill bits and Hilti vacuum cleaners

### Technical data

<b>Base material condition</b>	Dry, Submerged, Water-filled, Wet
<b>Environmental conditions</b>	Covered by ground soil, Highly corrosive special applications, Indoor, damp conditions, Indoor, dry conditions, Indoor, ventilated facades, Outdoor, Underwater, fresh water, Underwater, salty water
<b>Type of fastening</b>	Pre-fastening, Through-fastening
<b>Cleaning procedures</b>	Compressed-air cleaning
<b>Material composition</b>	Epoxy adhesive
<b>Installation direction</b>	All



### Approvals

ETA	ETA 09/0295 for HIT-RE 500-SD injection mortar for rebar (ETAG 001-05, Option 1)
ETA, Seismic	ETA 07/0260 HIT-RE 500-SD injection mortar for anchoring applications (ETAG 001-05, Option 1)

Approvals and test reports may apply to selected products only. Please refer to the documents for details.



Ordering designation	Content per can/cartridge	Shelf life from date of manufacture (at 23°C and 50% relative humidity)	Anchoring elements	Mixer extension included	Number of mixers included	Sales pack quantity	Item number
HIT-RE 500-SD/500/1	0.5 l	9 months	HAS threaded rods, HIS-N internally-threaded inserts, HIT-V threaded rods, Rebar	Yes	1	1 pc	387093

## Injectable mortar Hilti HIT-RE 500



### Key applications and advantages

- Structural connections with post-installed rebar (e.g. extension/connection to walls, slabs, stairs, columns, foundations, etc.)
- Anchoring structural steel connections (e.g. steel columns, beams, etc.)
- Anchoring secondary steel structures (e.g. balustrades, steel ledgers, etc.)
- High performance and technical superiority as per international approvals
- Especially suitable for large-diameter elements and/or deep embedment depths

### Technical data

<b>Base material condition</b>	Dry, Submerged, Water-filled, Wet
<b>Environmental conditions</b>	Highly corrosive special applications, Indoor, damp conditions, Indoor, dry conditions, Indoor, ventilated facades, Outdoor, Underwater, fresh water
<b>Type of fastening</b>	Pre-fastening, Through-fastening
<b>Cleaning procedures</b>	Compressed-air cleaning, Manual cleaning
<b>Material composition</b>	Epoxy adhesive
<b>Installation direction</b>	All



Ordering designation	Content per can/cartridge	Shelf life from date of manufacture (at 23°C and 50% relative humidity)	Anchoring elements	Mixer extension included	Number of mixers included	Sales pack quantity	Item number
HIT-RE 500/500/1 INT	0.5 l	9 months	HAS threaded rods, HIS-N internally-threaded inserts, HIT-V threaded rods, Other fasteners, Rebar	Yes	1	1 pc	426672
HIT-RE 500/1400/1 INT	1.4 l	9 months	HAS threaded rods, HIS-N internally-threaded inserts, HIT-V threaded rods, Other fasteners, Rebar	Yes	1	4 pc	426670

## Injectable mortar HIT-HY 200-R



### Key applications and advantages

- Anchoring structural steel connections (e.g. steel columns, beams)
- Anchoring safety barriers, balustrades, fire escape staircases
- Seismic strengthening / retrofitting and bracing of reinforced concrete buildings
- No hole cleaning required with the revolutionary new Hilti HIT-Z anchor rod
- Automatic hole cleaning with TE-CD and TE-YD drill bits in combination with Hilti vacuum cleaners

Technical data	
<b>Base material condition</b>	Dry, Wet
<b>Environmental conditions</b>	Covered by ground soil, Highly corrosive special applications, Indoor, damp conditions, Indoor, dry conditions, Indoor, ventilated facades, Outdoor
<b>Type of fastening</b>	Pre-fastening, Through-fastening
<b>Cleaning procedures</b>	Auto-cleaning with Hilti hollow drill bits, Compressed-air cleaning, Manual cleaning, No cleaning required with Hilti HIT-Z rod
<b>Material composition</b>	Hybrid urethane methacrylate adhesive
<b>Installation direction</b>	All

Approvals	
ETA	ETA-12/0083 for HIT-HY 200-R injection mortar for rebar (ETAG 001-05, Option -)
ETA, Seismic	ETA 12/0006 for HIT-HY 200-R injection mortar and HIT-Z(R) rod for anchoring applications (ETAG 001-05, Option 1) ETA 12/0084 for HIT-HY 200-R injection mortar and standard element for anchoring applications (ETAG 001-05, Option 1)
ICC-ES	ICC-ES ESR-3187 for HIT-HY 200 A/R injection mortar

Approvals and test reports may apply to selected products only. Please refer to the documents for details.



Ordering designation	Content per can/cartridge	Shelf life from date of manufacture (at 23°C and 50% relative humidity)	Anchoring elements	Compatibility sleeves	Mixer extension included	Number of mixers included	Sales pack quantity	Item number
HIT-HY 200-R 330/2/EE	0.33 l	12 months	HAS threaded rods, HIS-N internally-threaded inserts, HIT-V threaded rods, HIT-Z torque-controlled bonded anchors, HZA tension anchor, Rebar	No	Yes	2	1 pc	2045036
HIT-HY 200-R 500/2/EE	0.5 l	12 months	HAS threaded rods, HIS-N internally-threaded inserts, HIT-V threaded rods, HIT-Z torque-controlled bonded anchors, HZA tension anchor, Rebar	No	Yes	2	1 pc	2045032

Anchor Systems



**Key applications and advantages**

- Fastenings in cracked and uncracked concrete made with Hilti HIT HY200
- Fastenings where shallow embedment is required
- Very high loads in cracked concrete
- Very productive solution that saves cleaning time



Technical data	
<b>Anchor type</b>	Off-the-shelf rods
<b>Head configuration</b>	Externally threaded
<b>Environmental conditions</b>	Indoor, dry conditions
<b>Type of fastening</b>	Pre-fastening, Through-fastening
<b>Approvals / test reports</b>	ETA
<b>Material composition</b>	Steel, zinc-plated (min. 5 µm)
<b>Installation direction</b>	All
<b>Tested/approved for diamond drilling</b>	Yes
<b>PROFIS</b>	Yes
<b>Material, corrosion</b>	Steel, zinc-plated

Approvals	
ETA, Seismic	ETA 12/0006 for HIT-HY 200-A injection mortar and HIT-Z(R) rod for anchoring applications (ETAG 001-05, Option 1)
	ETA 12/0006 for HIT-HY 200-R injection mortar and HIT-Z(R) rod for anchoring applications (ETAG 001-05, Option 1)
ICC-ES	ICC-ES ESR-3187 for HIT-HY 200 A/R injection mortar

Approvals and test reports may apply to selected products only. Please refer to the documents for details.



**Anchor rod (metric) Hilti HIT-Z**



Ordering designation	Anchor size	Base plate clearance hole	Baseplate clearance hole pre-fastening	Base plate clearance hole through-fastening	Required tightening torque	Wrench size	Anchor length	Sales pack quantity	Item number
HIT-Z M8x80	M8	9 mm	9 mm	11 mm	10 Nm	13 mm	80 mm	40 pc	2018364
HIT-Z M8x100	M8	9 mm	9 mm	11 mm	10 Nm	13 mm	100 mm	40 pc	2018365
HIT-Z M8x120	M8	9 mm	9 mm	11 mm	10 Nm	13 mm	120 mm	40 pc	2018366
HIT-Z M10x95	M10	12 mm	12 mm	14 mm	25 Nm	17 mm	95 mm	40 pc	2018367
HIT-Z M10x115	M10	12 mm	12 mm	14 mm	25 Nm	17 mm	115 mm	40 pc	2018368
HIT-Z M10x135	M10	12 mm	12 mm	14 mm	25 Nm	17 mm	135 mm	40 pc	2018369
HIT-Z M10x160	M10	12 mm	12 mm	14 mm	25 Nm	17 mm	160 mm	40 pc	2018410
HIT-Z M12x105	M12	14 mm	14 mm	16 mm	40 Nm	19 mm	105 mm	20 pc	2018411
HIT-Z M12x140	M12	14 mm	14 mm	16 mm	40 Nm	19 mm	140 mm	20 pc	2018412
HIT-Z M12x155	M12	14 mm	14 mm	16 mm	40 Nm	19 mm	155 mm	20 pc	2018413
HIT-Z M12x196	M12	14 mm	14 mm	16 mm	40 Nm	19 mm	196 mm	20 pc	2018415
HIT-Z M16x155	M16	18 mm	18 mm	20 mm	80 Nm	24 mm	155 mm	12 pc	2018416
HIT-Z M16x175	M16	18 mm	18 mm	20 mm	80 Nm	24 mm	175 mm	12 pc	2018417
HIT-Z M16x205	M16	18 mm	18 mm	20 mm	80 Nm	24 mm	205 mm	12 pc	2018418
HIT-Z M16x240	M16	18 mm	18 mm	20 mm	80 Nm	24 mm	240 mm	12 pc	2018419
HIT-Z M20x215	M20	22 mm	22 mm	24 mm	150 Nm	30 mm	215 mm	6 pc	2018420
HIT-Z M20x250	M20	22 mm	22 mm	24 mm	150 Nm	30 mm	250 mm	6 pc	2018421

**Anchor rod (stainless metric) Hilti HIT-Z-R**



- Key applications and advantages**
- Fastenings in cracked and uncracked concrete made with Hilti HIT HY200
  - For applications where shallow embedment is needed
  - Very high loads in cracked concrete
  - Very productive solution that saves cleaning time



Technical data	
<b>Anchor type</b>	Off-the-shelf rods
<b>Head configuration</b>	Externally threaded
<b>Environmental conditions</b>	Covered by ground soil, Outdoor, Underwater, fresh water
<b>Type of fastening</b>	Pre-fastening, Through-fastening
<b>Approvals / test reports</b>	ETA
<b>Material composition</b>	Steel, A4 (SS316)
<b>Installation direction</b>	All
<b>Tested/approved for diamond drilling</b>	Yes
<b>PROFIS</b>	Yes
<b>Material, corrosion</b>	Steel, stainless

Ordering designation	Anchor size	Baseplate clearance hole pre-fastening	Base plate clearance hole through-fastening	Required tightening torque	Wrench size	Anchor length	Useable thread length	Sales pack quantity	Item number
HIT-Z-R M8x80	M8	9 mm	11 mm	10 Nm	13 mm	80 mm	8 mm	40 pc	2018422
HIT-Z-R M8x100	M8	9 mm	11 mm	10 Nm	13 mm	100 mm	28 mm	40 pc	2018423
HIT-Z-R M8x120	M8	9 mm	11 mm	10 Nm	13 mm	120 mm	48 mm	40 pc	2018424
HIT-Z-R M10x95	M10	12 mm	14 mm	25 Nm	17 mm	95 mm	22 mm	40 pc	2018425
HIT-Z-R M10x115	M10	12 mm	14 mm	25 Nm	17 mm	115 mm	42 mm	40 pc	2018426
HIT-Z-R M10x135	M10	12 mm	14 mm	25 Nm	17 mm	135 mm	62 mm	40 pc	2018427
HIT-Z-R M10x160	M10	12 mm	14 mm	25 Nm	17 mm	160 mm	87 mm	40 pc	2018428
HIT-Z-R M12x105	M12	14 mm	16 mm	40 Nm	19 mm	105 mm	29 mm	20 pc	2018429
HIT-Z-R M12x140	M12	14 mm	16 mm	40 Nm	19 mm	140 mm	64 mm	20 pc	2018430
HIT-Z-R M12x155	M12	14 mm	16 mm	40 Nm	19 mm	155 mm	79 mm	20 pc	2018431
HIT-Z-R M12x196	M12	14 mm	16 mm	40 Nm	19 mm	196 mm	120 mm	20 pc	2018433
HIT-Z-R M16x155	M16	18 mm	20 mm	80 Nm	24 mm	155 mm	38 mm	12 pc	2018434
HIT-Z-R M16x175	M16	18 mm	20 mm	80 Nm	24 mm	175 mm	58 mm	12 pc	2018435
HIT-Z-R M16x205	M16	18 mm	20 mm	80 Nm	24 mm	205 mm	88 mm	12 pc	2018436
HIT-Z-R M16x240	M16	18 mm	20 mm	80 Nm	24 mm	240 mm	123 mm	12 pc	2018437
HIT-Z-R M20x215	M20	22 mm	24 mm	150 Nm	30 mm	215 mm	91 mm	6 pc	2018438
HIT-Z-R M20x250	M20	22 mm	24 mm	150 Nm	30 mm	250 mm	126 mm	6 pc	2018439

### Hammer drill bit TE-YD

#### Key applications and advantages

- Drilling holes for anchoring structural steel connections (e.g. steel columns, beams)
- Drilling holes for structural connections with post-installed rebars
- Drilling holes for anchoring secondary steel structures (e.g. staircases, steel ledgers)
- Drilling and hole cleaning in one step
- Optimum hole cleaning for consistent anchor setting



Ordering designation	Diameter	Length	Working length	Sales pack quantity	Item number
TE-YDA		115 mm	0 mm	1 pc	2024360
TE-YD 16/59	16 mm	590 mm	400 mm	1 pc	2018956
TE-YD 18/59	18 mm	590 mm	400 mm	1 pc	2018957
TE-YD 20/59	20 mm	590 mm	400 mm	1 pc	2018959
TE-YD 22/59	22 mm	590 mm	400 mm	1 pc	2018960
TE-YD 25/59	25 mm	590 mm	400 mm	1 pc	2018962
TE-YD 28/59	28 mm	590 mm	400 mm	1 pc	2018964
TE-YD 32/59	32 mm	590 mm	400 mm	1 pc	2018966

### Hammer drill bit TE-CD

#### Key applications and advantages

- Drilling holes for anchoring structural steel connections (e.g. steel columns, beams)
- Drilling holes for structural connections with post-installed rebars
- Drilling holes for anchoring secondary steel structures (e.g. staircases, steel ledgers)
- Drilling and hole cleaning in one step
- Optimum hole cleaning for consistent anchor setting



Ordering designation	Diameter	Length	Working length	Sales pack quantity	Item number
TE-CDA				1 pc	2023719
TE-CD 12/33	12 mm	330 mm	200 mm	1 pc	2018940
TE-CD 14/37	14 mm	370 mm	240 mm	1 pc	2018942
TE-CD 16/37	16 mm	370 mm	240 mm	1 pc	2018945
TE-CD 18/37	18 mm	370 mm	240 mm	1 pc	2018946

## Injectable mortar HIT-HY 110



## Key applications and advantages

- Connection of secondary post-installed rebars
- Renovation / upgrades with post-installed rebars
- Substitution of misplaced / missing rebars
- Suitable for use in uncracked concrete with all anchor rods and rebar (ETA report)
- Post-installed rebars perform like cast-in connections

## Technical data

<b>Material composition</b>	Hybrid urethane methacrylate adhesive
<b>Tested/approved for diamond drilling</b>	No
<b>Storage and transportation temperature - max.</b>	25 °C
<b>Storage and transportation temperature - min.</b>	5 °C
<b>PROFIS</b>	No
<b>NSF listed</b>	Yes



Ordering designation	Content per can/cartridge	Shelf life from date of manufacture (at 23°C and 50% relative humidity)	Compatibility sleeves	Mixer extension included	Number of mixers included	Sales pack quantity	Item number
HIT-HY 110 330/2	0.33 l	12 months	No	Yes	2	1 pc	2078502
HIT-HY 110 500/2	0.5 l	12 months	No	Yes	2	1 pc	2078503

## Clean-Tec injectable mortar HIT-CT 1



## Key applications and advantages

- Rebar applications: structural connections (e.g. walls, slabs, stairs), structural repair, design corrections, bridge extensions, road widening, refurbishment / retrofitting
- Anchoring applications: structural steel (e.g. columns, beams), railings (e.g. balconies, hand rails), facade work / curtain walling, sound and crash barriers
- Meets high health and safety requirements: Non-hazardous and odourless
- Easy waste management: carries no hazard symbols, thus easily disposed of (in cured or uncured state) in standard Green DOT waste containers, avoiding costs for special waste handling on jobsites

## Technical data

<b>Base material condition</b>	Dry, Wet
<b>Environmental conditions</b>	Highly corrosive special applications, Indoor, damp conditions, Indoor, dry conditions, Outdoor
<b>Type of fastening</b>	Pre-fastening, Through-fastening
<b>Cleaning procedures</b>	Auto-cleaning with Hilti hollow drill bits, Compressed-air cleaning, Manual cleaning
<b>Material composition</b>	Hybrid urethane methacrylate adhesive
<b>Installation direction</b>	All



## Approvals

ETA	ETA 11/0354 for HIT-CT 1 injection mortar for anchoring applications (ETAG 001-05, Option 7)
	ETA 11/0390 for HIT-CT 1 injection mortar for rebar (ETAG 001-05, Option -)

Approvals and test reports may apply to selected products only. Please refer to the documents for details.



Ordering designation	Content per can/cartridge	Shelf life from date of manufacture (at 23°C and 50% relative humidity)	Anchoring elements	Compatibility sleeves	Mixer extension included	Number of mixers included	Sales pack quantity	Item number
HIT-CT1 330/2	0.33 l	9 months	HIT-V threaded rods, Rebar	No	Yes	2	1 pc	435992
HIT-CT1 500/2	0.5 l	9 months	HIT-V threaded rods, Rebar	No	Yes	2	1 pc	435993

## Injectable mortar HIT-HY 70



Technical data	
<b>Base material condition</b>	Dry, Wet
<b>Environmental conditions</b>	Indoor, damp conditions, Indoor, dry conditions, Indoor, ventilated facades, Outdoor
<b>Type of fastening</b>	Pre-fastening
<b>Cleaning procedures</b>	Compressed-air cleaning, Manual cleaning
<b>Material composition</b>	Hybrid urethane methacrylate adhesive
<b>Installation direction</b>	All



### Key applications and advantages

- Applications in hollow and solid masonry
- Suitable for glass structures
- For heavy bracing on insulated materials in applications such as the installation of sun shades
- Provides strong, reliable and easy-to-install fastenings in a variety of masonry materials
- For use in indoor and outdoor applications in dry or wet drilled holes

Ordering designation	Content per can/cartridge	Shelf life from date of manufacture (at 23°C and 50% relative humidity)	Anchoring elements	Compatibility sleeves	Mixer extension included	Number of mixers included	Sales pack quantity	Item number
HIT-HY 70 330/2	0.33 l	12 months	HAS threaded rods, HIS-N internally-threaded inserts, HIT-IC internally-threaded rods, HIT-V threaded rods, Other fasteners	Hilti HIT-SC, Hilti HIT-S	Yes	2	1 pc	383677
HIT-HY 70 500/2	0.5 l	12 months	HAS threaded rods, HIS-N internally-threaded inserts, HIT-IC internally-threaded rods, HIT-V threaded rods, Other fasteners	Hilti HIT-SC, Hilti HIT-S	Yes	2	1 pc	383681

## Injectable mortar HIT-MM PLUS



Technical data	
<b>Base material condition</b>	Dry, Wet
<b>Type of fastening</b>	Pre-fastening
<b>Cleaning procedures</b>	Manual cleaning
<b>Material composition</b>	Hybrid urethane methacrylate adhesive
<b>Installation direction</b>	All
<b>Storage and transportation temperature - max.</b>	25 °C



Anchor Systems

### Key applications and advantages



















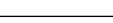







- Wide range of fastening applications in the medium load range in hollow block (with plastic sleeves), solid block and concrete where no approval is required
- Fence and railing posts, gates, window grills, non-structural rebars, wall cabinets, bathroom fittings, air conditioning systems, lights
- Surface treatment
- Easy dispensing thanks to well-proven manual, cordless and pneumatic dispensers
- Unique soft foil pack for less waste

Ordering designation	Content per can/cartridge	Shelf life from date of manufacture (at 23°C and 50% relative humidity)	Anchoring elements	Compatibility sleeves	Mixer extension included	Number of mixers included	Sales pack quantity	Item number
HIT-MM PLUS 330/1	0.33 l	12 months	HAS threaded rods, HIS-N internally-threaded inserts, HIT-IC internally-threaded rods, HIT-V threaded rods, Rebar	HIT-SC or HIT-IC	Yes	1	1 pc	2031401
HIT-MM PLUS 500/2	0.5 l	12 months	HAS threaded rods, HIS-N internally-threaded inserts, HIT-IC internally-threaded rods, HIT-V threaded rods, Rebar	HIT-SC or HIT-IC	Yes	2	1 pc	2031400

## Accessories for Injectible Adhesive Anchors











Ordering designation		Hilti HIT-RE 500	HIT-RE 500-SD	HIT-HY 200-R	HIT-CT 1	HIT-HY 70	HIT-MM PLUS	Sales pack quantity	Item number
Accessory kit Hit Premium Rebar cas		■	■	■	■			1 pc	2036986
Accessory kit Hit Premium Rebar cas		■	■	■	■			1 pc	2036989
Accessory kit Hit Profi Anchor box		■	■	■	■			1 pc	2036991
Accessory kit HIT PROFI anchor sys.		■	■	■	■			1 pc	2036988
Accessory kit Hit Profi Rebar box		■	■	■	■			1 pc	2036987
Accessory kit Hit Profi Rebar box		■	■	■	■			1 pc	2036990
Air nozzle HIT-DL 12		■	■	■	■	■		1 pc	371715
Air nozzle HIT-DL 14		■	■	■	■	■		1 pc	371716
Air nozzle HIT-DL 16		■	■	■	■	■		1 pc	371717
Air nozzle HIT-DL 18		■	■	■	■	■		1 pc	371718
Air nozzle HIT-DL 20		■	■	■	■	■		1 pc	371719
Air nozzle HIT-DL 25		■	■	■	■	■		1 pc	371720
Air nozzle HIT-DL 32		■	■	■	■	■		1 pc	371721
Blow-out gun G 1/4"		■	■	■	■	■	■	1 pc	381215
Blow-out pump		■	■	■	■	■	■	1 pc	60579
Brush extension HIT-RBH		■	■	■	■	■	■	1 pc	229138
Brush extension HIT-RBS-10/0.35		■	■	■	■	■	■	1 pc	371722
Brush extension HIT-RBS 10/0.7		■	■	■	■	■	■	1 pc	336645
Brush extension HIT-RBV		■	■	■	■	■	■	1 pc	238727
Cartridge holder HIT-CB 500		■	■		■	■	■	1 pc	2007057
Cartridge holder HIT-CR 500				■				1 pc	2007059
Cassette P 8000 D		■				■	■	1 pc	373960
Connecting piece HIT-DL V10/1		■	■	■	■	■	■	1 pc	336644

Accessories for Injectible Adhesive Anchors

Ordering designation		Hilti HIT-RE 500	HIT-RE 500-SD	HIT-HY 200-R	HIT-CT 1	HIT-HY 70	HIT-MM PLUS	Sales pack quantity	Item number
Coupler VL-K		■	■	■	■			10 pc	335021
Extension hose HIT-VL 16		■	■	■	■			1 pc	38249
Extension tube HIT-VL 16/0.7		■	■	■	■	■	■	10 pc	336646
Holder TE-C		■	■	■	■	■	■	1 pc	263437
Holder TE-Y		■	■	■	■	■	■	1 pc	263439
Hose HIT-VL 11/1.0		■	■	■	■			10 pc	2042533
Piston plug HIT-SZ 14		■	■	■	■			10 pc	2039309
Piston plug HIT-SZ 16		■	■	■	■			10 pc	2039310
Piston plug HIT-SZ 18		■	■	■	■			10 pc	2039311
Piston plug HIT-SZ 20		■	■	■	■			10 pc	2039312
Piston plug HIT-SZ 22		■	■	■	■			10 pc	2039313
Piston plug HIT-SZ 24		■	■	■	■			10 pc	2039314
Piston plug HIT-SZ 25		■	■	■	■			10 pc	2039315
Piston plug HIT-SZ 28		■	■	■	■			10 pc	2039316
Piston plug HIT-SZ 30		■	■	■	■			10 pc	2039317
Piston plug HIT-SZ 32		■	■	■	■			10 pc	2039318
Piston plug HIT-SZ 35		■	■	■	■			10 pc	2039319
Piston plug HIT-SZ 37		■	■	■	■			10 pc	2039320
Piston plug HIT-SZ 40		■	■	■	■			10 pc	2039325
Piston plug HIT-SZ 42		■	■	■	■			10 pc	2039326
Piston plug HIT-SZ 45		■	■	■	■			10 pc	2039331
Piston plug HIT-SZ 47		■	■	■	■			10 pc	2039332
Piston plug HIT-SZ 52		■	■	■	■			10 pc	2039333
Piston plug HIT-SZ 55		■	■	■	■			10 pc	2039334
Round brush 13 HG		■	■	■	■	■	■	1 pc	229133
Round brush 18 HG		■	■	■	■	■	■	1 pc	229134
Round brush 28 HG		■	■	■	■	■	■	1 pc	229135
Round steel brush HIT-RB 12		■	■	■	■	■	■	1 pc	336548
Round steel brush HIT-RB 14		■	■	■	■	■	■	1 pc	336549



## Accessories for Injectible Adhesive Anchors

Ordering designation		Hilti HIT-RE 500	HIT-RE 500-SD	HIT-HY 200-R	HIT-CT 1	HIT-HY 70	HIT-MM PLUS	Sales pack quantity	Item number
Round steel brush HIT-RB 16		■	■	■	■	■	■	1 pc	336550
Round steel brush HIT-RB 18		■	■	■	■	■	■	1 pc	336551
Round steel brush HIT-RB 20		■	■	■	■	■	■	1 pc	336552
Round steel brush HIT-RB 25		■	■	■	■	■	■	1 pc	336553
Round steel brush HIT-RB 32		■	■	■	■	■	■	1 pc	336554
Round steel brush HIT-RB 40		■	■	■	■	■	■	1 pc	382260
Round steel brush HIT-RB 42		■	■	■	■	■	■	1 pc	382261
Round steel brush HIT-RB 47		■	■	■	■	■	■	1 pc	382264
Round steel brush HIT-RB 52		■	■	■	■	■	■	1 pc	382265
Round steel brush HIT-RB 55		■	■	■	■	■	■	1 pc	382266

## Adhesive anchor system HVU-TZ



### Key applications and advantages

- Heavy-duty fastenings in cracked concrete and for dynamic loading (steel structures, machinery, crash and noise barriers, curtain wall structures, railings.)
- For safety-relevant fastenings
- Dynamic loads
- Suitable for use in cracked concrete
- Suitable for dynamic loading subject to fatigue and shock

Technical data	
<b>Base material condition</b>	Dry, Wet
<b>Environmental conditions</b>	Covered by ground soil, Highly corrosive special applications, Indoor, damp conditions, Indoor, dry conditions, Indoor, ventilated facades, Outdoor
<b>Type of fastening</b>	Pre-fastening
<b>Material composition</b>	Hybrid urethane methacrylate adhesive
<b>Installation direction</b>	All
<b>Storage and transportation temperature - max.</b>	25 °C



Ordering designation	Anchor size	Anchoring elements	Shelf life from date of manufacture (at 23°C and 50% relative humidity)	Standard embedment depth	Sales pack quantity	Item number
<b>HVU-TZ M10</b>	M10	HAS-TZ torque-controlled bonded anchor	18 months	75 mm	10 pc	<b>311368</b>
<b>HVU-TZ M12</b>	M12	HAS-TZ torque-controlled bonded anchor	18 months	95 mm	10 pc	<b>311369</b>
<b>HVU-TZ M16</b>	M16	HAS-TZ torque-controlled bonded anchor	18 months	105 mm	10 pc	<b>311370</b>
<b>HVU-TZ M20</b>	M20	HAS-TZ torque-controlled bonded anchor	18 months	170 mm	4 pc	<b>335942</b>

Technical data	
Anchor type	Off-the-shelf rods
Head configuration	Externally threaded
Environmental conditions	Indoor, dry conditions
Type of fastening	Pre-fastening
Material composition	Steel, 8.8 grade, zinc-plated (min. 5 µm)
Installation direction	All
PROFIS	Yes
Material, corrosion	Steel, zinc-plated
In-service temperature - min.	-40 °C
Accessories	HDA/HVZ



### Key applications and advantages

- Suitable for fastenings in cracked concrete in combination with Hilti HVU-TZ capsules
- HVZ combines highest performance in chemical anchors with an unparalleled level of safety
- Minimal sensitivity to cracked concrete (tension zone)

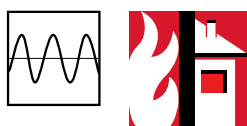

## Anchor rod (carbon steel) HAS-TZ



Ordering designation	Anchor size	Base plate clearance hole	Required tightening torque	Wrench size	Anchor length	Standard embedment depth	Max. fixture thickness at standard embedment depth	Sales pack quantity	Item number
HAS-TZ M10X75/30	M10	12 mm	40 Nm	17 mm	139 mm	75 mm	30 mm	10 pc	308383
HAS-TZ M10X75/50	M10	12 mm	40 Nm	17 mm	159 mm	75 mm	50 mm	10 pc	308384
HAS-TZ M10X75/15	M10	12 mm	40 Nm	17 mm	124 mm	75 mm	15 mm	10 pc	310018
HAS-TZ M12X95/25	M12	14 mm	50 Nm	19 mm	158 mm	95 mm	25 mm	10 pc	308385
HAS-TZ M12X95/50	M12	14 mm	50 Nm	19 mm	183 mm	95 mm	50 mm	10 pc	308386
HAS-TZ M12X95/100	M12	14 mm	50 Nm	19 mm	233 mm	95 mm	100 mm	10 pc	308387
HAS-TZ M16X105/30	M16	18 mm	90 Nm	24 mm	181 mm	105 mm	30 mm	5 pc	308388
HAS-TZ M16X105/60	M16	18 mm	90 Nm	24 mm	211 mm	105 mm	60 mm	5 pc	308389
HAS-TZ M16X105/100	M16	18 mm	90 Nm	24 mm	251 mm	105 mm	100 mm	5 pc	308390
HAS-TZ M16X125/30	M16	18 mm	90 Nm	24 mm	201 mm	125 mm	30 mm	5 pc	332519
HAS-TZ M16X125/60	M16	18 mm	90 Nm	24 mm	231 mm	125 mm	60 mm	5 pc	332520
HAS-TZ M20X170/40	M20	22 mm	150 Nm	30 mm	269 mm	170 mm	40 mm	4 pc	335943

## Anchor rod (A4 stainless steel) HAS-RTZ



### Key applications and advantages

- Suitable for fastenings in cracked concrete in combination with Hilti HVU-TZ capsules
- HVZ combines highest chemical anchor performance with an unparalleled level of safety
- Minimal sensitivity to cracked concrete (tension zone)

### Technical data

Anchor type	Off-the-shelf rods
Head configuration	Externally threaded
Environmental conditions	Covered by ground soil, Outdoor, Underwater, fresh water
Type of fastening	Pre-fastening
Material composition	Steel, A4 (SS316)
Installation direction	All
PROFIS	Yes
Material, corrosion	Steel, stainless
In-service temperature - min.	-40 °C



Ordering designation	Anchor size	Base plate clearance hole	Required tightening torque	Wrench size	Anchor length	Standard embedment depth	Max. fixture thickness at standard embedment depth	Sales pack quantity	Item number
HAS-RTZ M10X75/30	M10	12 mm	50 Nm	17 mm	139 mm	75 mm	30 mm	10 pc	308391
HAS-RTZ M10X75/15	M10	12 mm	50 Nm	17 mm	124 mm	75 mm	15 mm	10 pc	310019
HAS-RTZ M12X95/25	M12	14 mm	70 Nm	19 mm	158 mm	95 mm	25 mm	10 pc	308393
HAS-RTZ M12X95/50	M12	14 mm	70 Nm	19 mm	183 mm	95 mm	50 mm	10 pc	308394
HAS-RTZ M12X95/100	M12	14 mm	70 Nm	19 mm	233 mm	95 mm	100 mm	10 pc	308395
HAS-RTZ M16X105/30	M16	18 mm	100 Nm	24 mm	181 mm	105 mm	30 mm	5 pc	308396
HAS-RTZ M16X105/60	M16	18 mm	100 Nm	24 mm	211 mm	105 mm	60 mm	5 pc	308397

Ordering designation	Anchor size	Base plate clearance hole	Required tightening torque	Wrench size	Anchor length	Standard embedment depth	Max. fixture thickness at standard embedment depth	Sales pack quantity	Item number
HAS-RTZ M16X105/100	M16	18 mm	100 Nm	24 mm	251 mm	105 mm	100 mm	5 pc	308398
HAS-RTZ M16X125/30	M16	18 mm	100 Nm	24 mm	201 mm	125 mm	30 mm	5 pc	332522
HAS-RTZ M16X125/60	M16	18 mm	100 Nm	24 mm	231 mm	125 mm	60 mm	5 pc	332523
HAS-RTZ M16X125/100	M16	18 mm	100 Nm	24 mm	271 mm	125 mm	100 mm	5 pc	332524
HAS-RTZ M20X170/40	M20	22 mm	150 Nm	30 mm	269 mm	170 mm	40 mm	4 pc	335944

**Foil capsule adhesive anchor HVU**



Technical data	
Base material condition	Dry, Wet
Environmental conditions	Covered by ground soil, Highly corrosive special applications, Indoor, damp conditions, Indoor, dry conditions, Indoor, ventilated facades, Outdoor
Type of fastening	Pre-fastening
Material composition	Hybrid urethane methacrylate adhesive
Installation direction	All
Storage and transportation temperature - max.	25 °C



**Key applications and advantages**

- Anchoring structural steel connections (e.g. steel columns, beams, etc.)
- Anchoring in road and tunnel applications (crash and noise barriers, overhead catenary systems)
- Flexible foil capsule instead of glass: A robust solution for real jobsite conditions
- One system for many applications thanks to a wide range of adhesive capsules, anchor rods and internally threaded sleeves in various diameters and lengths



Ordering designation	Anchoring elements	Shelf life from date of manufacture (at 23°C and 50% relative humidity)	Standard embedment depth	Sales pack quantity	Item number
HVU M8x80	HAS threaded rods, HIS-N internally-threaded inserts	18 months	80 mm	10 pc	256691
HVU M10x90	HAS threaded rods, HIS-N internally-threaded inserts	18 months	90 mm	10 pc	256692
HVU M12x110	HAS threaded rods, HIS-N internally-threaded inserts	18 months	110 mm	10 pc	256693
HVU M16x125	HAS threaded rods, HIS-N internally-threaded inserts	18 months	125 mm	10 pc	256694
HVU M10x135	HAS threaded rods, HIS-N internally-threaded inserts	18 months	135 mm	20 pc	307914
HVU M12x165	HAS threaded rods, HIS-N internally-threaded inserts	18 months	165 mm	20 pc	307915
HVU M20x170	HAS threaded rods, HIS-N internally-threaded inserts	18 months	170 mm	5 pc	256695
HVU M16x190	HAS threaded rods, HIS-N internally-threaded inserts	18 months	190 mm	10 pc	307916
HVU M24x210	HAS threaded rods, HIS-N internally-threaded inserts	18 months	210 mm	5 pc	256696
HVU M24x210 BULK	HAS threaded rods, HIS-N internally-threaded inserts	18 months	210 mm	100 pc	334746
HVU M27x240	HAS threaded rods, HIS-N internally-threaded inserts	18 months	240 mm	4 pc	256697
HVU M20x255	HAS threaded rods, HIS-N internally-threaded inserts	18 months	255 mm	5 pc	307917
HVU M30x270	HAS threaded rods, HIS-N internally-threaded inserts	18 months	270 mm	4 pc	256698
HVU M33x300	HAS threaded rods, HIS-N internally-threaded inserts	18 months	300 mm	4 pc	256699
HVU M36x330	HAS threaded rods, HIS-N internally-threaded inserts	18 months	330 mm	2 pc	256700
HVU M39x360	HAS threaded rods, HIS-N internally-threaded inserts	18 months	360 mm	2 pc	256701

Anchor Systems



### Key applications and advantages

- Features a chisel tip to cut and mix the Hilti HVU capsule, embedment marking for easy setting and a conical head (M10-M24 only)
- Large range of anchor rods (M8-M39)



### Technical data

<b>Anchor type</b>	Off-the-shelf rods
<b>Head configuration</b>	Externally threaded
<b>Environmental conditions</b>	Indoor, dry conditions
<b>Type of fastening</b>	Pre-fastening
<b>Material composition</b>	Steel, 5.8 grade, zinc-plated (min. 5 µm)
<b>Installation direction</b>	All
<b>PROFIS</b>	Yes
<b>Material, corrosion</b>	Steel, zinc-plated
<b>In-service temperature - min.</b>	-40 °C

### Approvals

ETA	ETA 04/0027 for HIT-RE 500 injection mortar for anchoring applications (ETAG 001-05, Option 7)
	ETA 05/0255 for HVU adhesive capsules (ETAG 001-05, Option 7)
	ETA 08/0352 for HIT-HY 150 MAX injection mortar for anchoring applications (ETAG 001-05, Option 7)
	ETA 09/0265 for HIT-HY 70 injection mortar for anchoring applications in concrete (ETAG 001-05, Option 7)

Approvals and test reports may apply to selected products only. Please refer to the documents for details.



## Anchor rod (5.8 carbon steel) HAS-E



Ordering designation	Anchor size	Base plate clearance hole	Wrench/nut size	Wrench size	Anchor length	Standard embedment depth	Max. fixture thickness at standard embedment depth	Sales pack quantity	Item number
HAS-E-5.8 M8x80/54	M8	10 mm	13 mm	13 mm	150 mm	80 mm	54 mm	10 pc	333099
HAS-E-5.8 M8x80/14	M8	10 mm	13 mm	13 mm	110 mm	80 mm	14 mm	20 pc	332219
HAS-E-5.8 M10x90/61	M10	12 mm		17 mm	170 mm	90 mm	61 mm	10 pc	333100
HAS-E-5.8 M10x90/81	M10	12 mm		17 mm	190 mm	90 mm	81 mm	10 pc	333101
HAS-E-5.8 M10x90/21	M10	12 mm		17 mm	130 mm	90 mm	21 mm	20 pc	332220
HAS-E-5.8 M12x110/88	M12	14 mm		19 mm	220 mm	110 mm	88 mm	10 pc	333102
HAS-E-5.8 M12x110/128	M12	14 mm		19 mm	260 mm	110 mm	128 mm	10 pc	333103
HAS-E-5.8 M12x110/168	M12	14 mm		19 mm	300 mm	110 mm	168 mm	10 pc	333104
HAS-E-5.8 M12x110/28	M12	14 mm		19 mm	160 mm	110 mm	28 mm	20 pc	332221
HAS-E-5.8 M16x125/20	M16	18 mm		24 mm	164 mm	125 mm	20 mm	10 pc	333105
HAS-E-5.8 M16x125/108	M16	18 mm		24 mm	260 mm	125 mm	108 mm	10 pc	333106
HAS-E-5.8 M16x125/148	M16	18 mm		24 mm	300 mm	125 mm	148 mm	10 pc	333107
HAS-E-5.8 M16x125/198	M16	18 mm		24 mm	350 mm	125 mm	198 mm	10 pc	333108
HAS-E-5.8 M16x125/348	M16	18 mm		24 mm	500 mm	125 mm	348 mm	10 pc	333109
HAS-E-5.8 M16x125/38	M16	18 mm		24 mm	190 mm	125 mm	38 mm	20 pc	332222
HAS-E-5.8 M20x170/48	M20	22 mm		30 mm	240 mm	170 mm	48 mm	10 pc	332223
HAS-E-5.8 M20x170/68	M20	22 mm		30 mm	260 mm	170 mm	68 mm	10 pc	333110
HAS-E-5.8 M20x170/108	M20	22 mm		30 mm	300 mm	170 mm	108 mm	10 pc	333111
HAS-E-5.8 M20x170/158	M20	22 mm		30 mm	350 mm	170 mm	158 mm	10 pc	333112
HAS-E-5.8 M20x170/208	M20	22 mm		30 mm	400 mm	170 mm	208 mm	10 pc	333113
HAS-E M24X210/124	M24	26 mm		36 mm	335 mm	210 mm	124 mm	5 pc	77210
HAS-E-5.8 M24x210/164	M24	26 mm		36 mm	400 mm	210 mm	164 mm	10 pc	27893
HAS-E-5.8 M24x210/54	M24	26 mm		36 mm	290 mm	210 mm	54 mm	10 pc	332224

## Anchor rod HAS-E-F



### Key applications and advantages

- Incorporates a chisel-shaped end to cut and mix the Hilti HVU capsule, embedment marking for easy setting, and a conical head
- Large family of anchor rods (M8-M39)



### Technical data

<b>Anchor type</b>	Off-the-shelf rods
<b>Head configuration</b>	Externally threaded
<b>Environmental conditions</b>	Indoor, damp conditions, Outdoor
<b>Type of fastening</b>	Pre-fastening
<b>Material composition</b>	Steel, 5.8 grade, hot-dip galvanized (min. 43 µm)
<b>Installation direction</b>	All
<b>PROFIS</b>	Yes
<b>Material, corrosion</b>	Steel, sherardised / hot-dip galvanised
<b>In-service temperature - min.</b>	-40 °C

Ordering designation	Anchor size	Base plate clearance hole	Wrench size	Anchor length	Standard embedment depth	Max. fixture thickness at standard embedment depth	Drilling depth	Sales pack quantity	Item number
HAS-E-F-5.8 M8x80/14	M8	9 mm	13 mm	110 mm	80 mm	14 mm	80 mm	20 pc	333143
HAS-E-F-5.8 M8x80/54	M8	9 mm	13 mm	150 mm	80 mm	54 mm	80 mm	10 pc	333144
HAS-E-F-5.8 M10x90/21	M10	12 mm	17 mm	130 mm	90 mm	21 mm	90 mm	20 pc	333145
HAS-E-F-5.8 M10x90/61	M10	12 mm	17 mm	170 mm	90 mm	61 mm	90 mm	10 pc	333146
HAS-E-F-5.8 M12x110/28	M12	14 mm	19 mm	160 mm	110 mm	28 mm	110 mm	20 pc	333148
HAS-E-F-5.8 M12x110/88	M12	14 mm	19 mm	220 mm	110 mm	88 mm	110 mm	10 pc	333149
HAS-E-F-5.8 M12x110/168	M12	14 mm	19 mm	300 mm	110 mm	168 mm	110 mm	10 pc	333151
HAS-E-F-5.8 M16x125/20	M16	18 mm	24 mm	172 mm	125 mm	20 mm	125 mm	10 pc	333152
HAS-E-F-5.8 M16x125/38	M16	18 mm	24 mm	190 mm	125 mm	38 mm	125 mm	20 pc	333153
HAS-E-F-5.8 M16x125/108	M16	18 mm	24 mm	260 mm	125 mm	108 mm	125 mm	10 pc	333154
HAS-E-F-5.8 M16x125/148	M16	18 mm	24 mm	300 mm	125 mm	148 mm	125 mm	10 pc	333155
HAS-E-F-5.8 M16x125/198	M16	18 mm	24 mm	350 mm	125 mm	198 mm	125 mm	10 pc	333156
HAS-E-F-5.8 M16x125/348	M16	18 mm	24 mm	500 mm	125 mm	348 mm	125 mm	10 pc	333157
HAS-E-F-5.8 M20x170/48	M20	22 mm	30 mm	240 mm	170 mm	48 mm	170 mm	10 pc	333158
HAS-E-F-5.8 M20x170/68	M20	22 mm	30 mm	260 mm	170 mm	68 mm	170 mm	10 pc	333159
HAS-E-F-5.8 M20x170/108	M20	22 mm	30 mm	300 mm	170 mm	108 mm	170 mm	10 pc	333160
HAS-E-F-5.8 M20x170/158	M20	22 mm	30 mm	350 mm	170 mm	158 mm	170 mm	10 pc	333161
HAS-E-F-5.8 M20x170/208	M20	22 mm	30 mm	400 mm	170 mm	208 mm	170 mm	10 pc	333162
HAS-E-F-5.8 M24x210/54	M24	26 mm	36 mm	290 mm	210 mm	54 mm	210 mm	10 pc	333163

**Anchor rod HAS-E-R**



**Key applications and advantages**

- Incorporates a chisel-shaped end to cut and mix the Hilti HVU capsule, embedment marking for easy setting, and a conical head (M8-M24 only)
- Large family of anchor rods (M8-M39)

**Technical data**

<b>Anchor type</b>	Off-the-shelf rods
<b>Head configuration</b>	Externally threaded
<b>Environmental conditions</b>	Covered by ground soil, Outdoor, Underwater, fresh water
<b>Type of fastening</b>	Pre-fastening
<b>Material composition</b>	Steel, A4 (SS316)
<b>Installation direction</b>	All
<b>PROFIS</b>	Yes
<b>Material, corrosion</b>	Steel, stainless
<b>In-service temperature - min.</b>	-40 °C



Ordering designation	Anchor size	Base plate clearance hole	Wrench size	Anchor length	Standard embedment depth	Max. fixture thickness at standard embedment depth	Drilling depth	Sales pack quantity	Item number
HAS-E-R M8x80/14	M8	9 mm	13 mm	110 mm	80 mm	14 mm	80 mm	20 pc	333119
HAS-E-R M8x80/54	M8	9 mm	13 mm	150 mm	80 mm	54 mm	80 mm	10 pc	333120
HAS-E-R M8x80/114	M8	9 mm	13 mm	210 mm	80 mm	114 mm	80 mm	10 pc	333121
HAS-E-R M10x90/21	M10	12 mm	17 mm	130 mm	90 mm	21 mm	90 mm	20 pc	333122
HAS-E-R M10x90/61	M10	12 mm	17 mm	170 mm	90 mm	61 mm	90 mm	10 pc	333123
HAS-E-R M10x90/81	M10	12 mm	17 mm	190 mm	90 mm	81 mm	90 mm	10 pc	333124
HAS-E-R M10x90/111	M10	12 mm	17 mm	220 mm	90 mm	111 mm	90 mm	10 pc	333125
HAS-E-R M12x110/28	M12	14 mm	19 mm	160 mm	110 mm	28 mm	110 mm	20 pc	333126
HAS-E-R M12x110/88	M12	14 mm	19 mm	220 mm	110 mm	88 mm	110 mm	10 pc	333127
HAS-E-R M12x110/128	M12	14 mm	19 mm	260 mm	110 mm	128 mm	110 mm	10 pc	333128
HAS-E-R M16x125/20	M16	18 mm	24 mm	164 mm	125 mm	20 mm	125 mm	10 pc	333130
HAS-E-R M16x125/38	M16	18 mm	24 mm	190 mm	125 mm	38 mm	125 mm	20 pc	333131
HAS-E-R M16x125/108	M16	18 mm	24 mm	260 mm	125 mm	108 mm	125 mm	10 pc	333132
HAS-E-R M16x125/148	M16	18 mm	24 mm	300 mm	125 mm	148 mm	125 mm	10 pc	333133
HAS-E-R M16x125/198	M16	18 mm	24 mm	350 mm	125 mm	198 mm	125 mm	10 pc	333134
HAS-E-R M20x170/48	M20	22 mm	30 mm	240 mm	170 mm	48 mm	170 mm	10 pc	333135
HAS-E-R M20x170/108	M20	22 mm	30 mm	300 mm	170 mm	108 mm	170 mm	10 pc	333136
HAS-E-R M24x210/54	M24	26 mm	36 mm	290 mm	210 mm	54 mm	210 mm	10 pc	333137
HAS-E-R M27x240/60	M27	30 mm	41 mm	340 mm	240 mm	60 mm	240 mm	4 pc	333138
HAS-E-R M30x270/70	M30	33 mm	46 mm	380 mm	270 mm	70 mm	270 mm	4 pc	333139
HAS-E-R M33x300/80	M33	36 mm	50 mm	420 mm	300 mm	80 mm	300 mm	4 pc	333140
HAS-E-R M36x330/90	M36	39 mm	55 mm	460 mm	330 mm	90 mm	330 mm	2 pc	333141

## Anchor rod HAS-E-HCR



### Key applications and advantages

- Suitable for fastenings in concrete and hard natural stone in conjunction with HVU capsules, HIT-HY 150, HIT-RE 500, HIT-MM, and HFX
- Suitable for fastenings in masonry in conjunction with HIT-HY 70, HIT MM, and HFX (M6-M12)
- Incorporates a chisel-shaped end to cut and mix the HVU capsule, embedment marking for easy setting and a conical head
- Large range of anchor rods (M8-M24)

### Technical data

<b>Anchor type</b>	Off-the-shelf rods
<b>Head configuration</b>	Externally threaded
<b>Environmental conditions</b>	Highly corrosive special applications, Underwater, salty water
<b>Type of fastening</b>	Pre-fastening
<b>Material composition</b>	Steel, high corrosion resistant (HCR)
<b>Installation direction</b>	All
<b>PROFIS</b>	Yes
<b>Material, corrosion</b>	Steel, high corrosion resistant (HCR)
<b>In-service temperature - min.</b>	-40 °C

Ordering designation	Anchor size	Base plate clearance hole	Wrench size	Anchor length	Standard embedment depth	Max. fixture thickness at standard embedment depth	Drilling depth	Sales pack quantity	Item number
HAS-E-HCR M8X90/14	M8	10 mm	13 mm	110 mm	80 mm	14 mm	80 mm	20 pc	229504
HAS-E-HCR M10X90/21	M10	12 mm	17 mm	130 mm	90 mm	21 mm	90 mm	10 pc	229505
HAS-E-HCR M12X110/28	M12	14 mm	19 mm	160 mm	110 mm	28 mm	110 mm	10 pc	229506
HAS-E-HCR M20X170/48	M20	22 mm	30 mm	240 mm	170 mm	48 mm	170 mm	5 pc	229508
HAS-E-HCR M24X210/54	M24	24 mm	36 mm	290 mm	210 mm	54 mm	210 mm	5 pc	229509
HAS-E-HCR M20X170/48	M20	22 mm	30 mm	240 mm	170 mm	48 mm	170 mm	5 pc	229508
HAS-E-HCR M24X210/54	M24	24 mm	36 mm	290 mm	210 mm	54 mm	210 mm	5 pc	229509



**Key applications and advantages**

- Suitable for internally threaded fastenings in concrete with various Hilti injectable adhesives and Hilti HVU capsules
- Internally threaded, allowing flush installation and easy removal of bolts
- Roof-shaped tip for cutting and mixing the Hilti HVU capsule (to be installed with HIS-S setting tool)



Technical data	
<b>Anchor type</b>	Internally threaded
<b>Head configuration</b>	Inner thread
<b>Environmental conditions</b>	Indoor, dry conditions
<b>Type of fastening</b>	Pre-fastening
<b>Material composition</b>	Steel, 5.8 grade, zinc-plated (min. 5 µm)
<b>Installation direction</b>	All
<b>PROFIS</b>	Yes
<b>Material, corrosion</b>	Steel, zinc-plated
<b>In-service temperature - min.</b>	-40 °C

Approvals	
ETA	ETA 04/0027 for HIT-RE 500 injection mortar for anchoring applications (ETAG 001-05, Option 7)
	ETA 05/0255 for HVU adhesive capsules (ETAG 001-05, Option 7)
	ETA 08/0352 for HIT-HY 150 MAX injection mortar for anchoring applications (ETAG 001-05, Option 7)
	ETA 11/0493 for HIT-HY 200-A injection mortar and standard element for anchoring application (ETAG 001-05, Option 1)
ETA, Seismic	ETA 07/0260 HIT-RE 500-SD injection mortar for anchoring applications (ETAG 001-05, Option 1)
	ETA 12/0084 for HIT-HY 200-R injection mortar and standard element for anchoring applications (ETAG 001-05, Option 1)

Approvals and test reports may apply to selected products only. Please refer to the documents for details.



**Internal threaded sleeve (metric) HIS-N**



Ordering designation	Anchor size	Thread engagement depth - max.	Thread engagement depth - min.	Base plate clearance hole	Outside diameter	Anchor length	Standard embedment depth	Sales pack quantity	Item number
HIS-N M8x90	M8	20 mm	8 mm	9 mm	13 mm	90 mm	90 mm	10 pc	258015
HIS-N M10x110	M10	25 mm	10 mm	12 mm	17 mm	110 mm	110 mm	10 pc	258016
HIS-N M12x125	M12	30 mm	12 mm	14 mm	21 mm	125 mm	125 mm	5 pc	258017
HIS-N M16x170	M16	40 mm	16 mm	18 mm	25 mm	170 mm	170 mm	5 pc	258018
HIS-N M20x205	M20	50 mm	20 mm	22 mm	28 mm	205 mm	205 mm	5 pc	258019

**Internal threaded sleeve (metric stainless) HIS-RN**



- Key applications and advantages**
- Internally threaded, allowing flush installation and easy removal of bolts
  - Roof-shaped tip for cutting and mixing the Hilti HVU capsule (to be installed with HIS-S setting tool)



Technical data	
<b>Anchor type</b>	Internally threaded
<b>Head configuration</b>	Inner thread
<b>Environmental conditions</b>	Covered by ground soil, Outdoor, Underwater, fresh water
<b>Type of fastening</b>	Pre-fastening
<b>Material composition</b>	Steel, A4 (SS316)
<b>Installation direction</b>	All
<b>PROFIS</b>	Yes
<b>Material, corrosion</b>	Steel, stainless

Ordering designation	Anchor size	Internal thread size	Thread engagement depth - max.	Thread engagement depth - min.	Base plate clearance hole	Outside diameter	Anchor length	Sales pack quantity	Item number
HIS-RN M8x90 A4	M8	8 mm	20 mm	8 mm	9 mm	13 mm	90 mm	10 pc	258024
HIS-RN M10x110 A4	M10	10 mm	25 mm	10 mm	12 mm	17 mm	110 mm	10 pc	258025
HIS-RN M12x125 A4	M12	12 mm	30 mm	12 mm	14 mm	21 mm	125 mm	5 pc	258026
HIS-RN M16x170 A4	M16	16 mm	40 mm	16 mm	18 mm	25 mm	170 mm	5 pc	258027
HIS-RN M20x205 A4	M20	20 mm	50 mm	20 mm	22 mm	28 mm	205 mm	5 pc	258028





### Key applications and advantages

- Suitable for fastenings in concrete in combination with the relevant Hilti HIT injectable adhesive mortar
- Suitable for fastenings in masonry in combination with Hilti HIT-HY 70
- For applications where embedment depth is between 4x - 20x rod diameter
- Flexibility: approved embedment depth between 4 to 20 times rod diameter allows shallow fastenings in thin concrete slabs or walls
- Productivity: use of optimal rod length and diameter saves time and money with every fastening



Technical data	
<b>Anchor type</b>	Off-the-shelf rods
<b>Head configuration</b>	Externally threaded
<b>Environmental conditions</b>	Indoor, dry conditions
<b>Type of fastening</b>	Pre-fastening, Through-fastening
<b>Material composition</b>	Steel, 5.8 grade, zinc-plated (min. 5 µm)
<b>Installation direction</b>	All
<b>PROFIS</b>	Yes
<b>Material, corrosion</b>	Steel, zinc-plated
<b>In-service temperature - min.</b>	-40 °C
<b>Accessories</b>	HIT-CB

### Approvals

ETA	ETA 04/0027 for HIT-RE 500 injection mortar for anchoring applications (ETAG 001-05, Option 7)
	ETA 08/0352 for HIT-HY 150 MAX injection mortar for anchoring applications (ETAG 001-05, Option 7)
	ETA 09/0265 for HIT-HY 70 injection mortar for anchoring applications in concrete (ETAG 001-05, Option 7)
	ETA 11/0354 for HIT-CT 1 injection mortar for anchoring applications (ETAG 001-05, Option 7)
ETA, Seismic	ETA 07/0260 HIT-RE 500-SD injection mortar and standard element for anchoring applications (ETAG 001-05, Option 1)
	ETA 11/0493 for HIT-HY 200-A injection mortar and standard element for anchoring application (ETAG 001-05, Option 1)
	ETA 12/0084 for HIT-HY 200-R injection mortar and standard element for anchoring applications (ETAG 001-05, Option 1)

Approvals and test reports may apply to selected products only. Please refer to the documents for details.



## Anchor rod (5.8 carbon steel) HIT-V-5.8



Ordering designation	Anchor size	Base plate clearance hole	Wrench size	Anchor length	Useable thread length	Standard embedment depth	Drilling depth	Sales pack quantity	Item number
HIT-V-5.8 M6x75	M6	7 mm	10 mm	75 mm	63 mm	70 mm	60 mm	20 pc	387144
HIT-V-5.8 M6x105	M6	7 mm	10 mm	105 mm	93 mm	70 mm	80 mm	20 pc	387145
HIT-V-5.8 M8x80	M8	9 mm	13 mm	80 mm	65 mm	60 mm	60 mm	20 pc	387054
HIT-V-5.8 M8x110	M8	9 mm	13 mm	110 mm	95 mm	80 mm	80 mm	20 pc	387055
HIT-V-5.8 M10x95	M10	12 mm	17 mm	95 mm	78 mm	60 mm	90 mm	10 pc	387057
HIT-V-5.8 M10x115	M10	12 mm	17 mm	115 mm	98 mm	90 mm	90 mm	10 pc	387146
HIT-V-5.8 M10x130	M10	12 mm	17 mm	130 mm	113 mm	90 mm	90 mm	10 pc	387058
HIT-V-5.8 M12x110	M12	14 mm	19 mm	110 mm	91 mm	110 mm	70 mm	10 pc	387060
HIT-V-5.8 M12x120	M12	14 mm	19 mm	120 mm	101 mm	110 mm	110 mm	10 pc	387147
HIT-V-5.8 M12x150	M12	14 mm	19 mm	150 mm	131 mm	110 mm	110 mm	10 pc	387061
HIT-V-5.8 M16x150	M16	18 mm	24 mm	150 mm	127 mm	80 mm	125 mm	5 pc	387064
HIT-V-5.8 M16x200	M16	18 mm	24 mm	200 mm	177 mm	125 mm	125 mm	5 pc	387065
HIT-V-5.8 M16x300	M16	18 mm	24 mm	300 mm	277 mm	125 mm	125 mm	5 pc	387066
HIT-V-5.8 M20x180	M20	22 mm	30 mm	180 mm	153 mm	90 mm	170 mm	5 pc	387068
HIT-V-5.8 M20x260	M20	22 mm	30 mm	260 mm	233 mm	170 mm	170 mm	5 pc	387069
HIT-V-5.8 M20x380	M20	22 mm	30 mm	380 mm	353 mm	170 mm	170 mm	10 pc	387070
HIT-V-5.8 M20x480	M20	22 mm	30 mm	480 mm	453 mm	170 mm	170 mm	10 pc	387071
HIT-V-5.8 M24x300	M24	26 mm	36 mm	300 mm	268 mm	210 mm	210 mm	5 pc	387072
HIT-V-5.8 M24x450	M24	26 mm	36 mm	450 mm	418 mm	210 mm	210 mm	5 pc	387073

### Anchor rod HIT-V 8.8



#### Key applications and advantages

- Suitable for fastenings in masonry in conjunction with Hilti HIT-HY 70
- For embedment depths of 4x - 20x rod diameter
- Flexibility: approved embedment depth between 4 to 20 times rod diameter allows shallow fastenings in thin concrete slabs or walls
- Productivity: use of optimum rod length and diameter saves time and money in each fastening job

#### Technical data

<b>Anchor type</b>	Off-the-shelf rods
<b>Head configuration</b>	Externally threaded
<b>Environmental conditions</b>	Indoor, dry conditions
<b>Type of fastening</b>	Pre-fastening, Through-fastening
<b>Material composition</b>	Steel, 8.8 grade, zinc-plated (min. 5 µm)
<b>Installation direction</b>	All
<b>PROFIS</b>	Yes
<b>Material, corrosion</b>	Steel, zinc-plated
<b>In-service temperature - min.</b>	-40 °C
<b>Accessories</b>	HIT-CB



Ordering designation	Anchor size	Base plate clearance hole	Required tightening torque	Wrench size	Anchor length	Useable thread length	Standard embedment depth	Sales pack quantity	Item number
HIT-V-8.8 M8x150	M8	10 mm	10 Nm	13 mm	150 mm	135 mm	80 mm	20 pc	387056
HIT-V-8.8 M10x190	M10	12 mm	20 Nm	17 mm	190 mm	173 mm	90 mm	10 pc	387059
HIT-V-8.8 M12x220	M12	14 mm	40 Nm	19 mm	220 mm	201 mm	110 mm	10 pc	387062
HIT-V-8.8 M12x280	M12	14 mm	40 Nm	19 mm	280 mm	261 mm	110 mm	10 pc	387063
HIT-V-8.8 M16x380	M16	18 mm	80 Nm	24 mm	380 mm	357 mm	125 mm	5 pc	387067

### Anchor rod (5.8 hot-dip galvanized) HIT-V-F (5.8 hot-dip galvanized)



#### Key applications and advantages

- Suitable for fastenings in concrete in conjunction with the relevant Hilti HIT injectable adhesive anchoring systems
- Suitable for fastenings in masonry in combination with Hilti HIT-HY 70
- For embedment depths of 4x - 20x rod diameter
- Flexibility: approved embedment depth between 4 to 20 times rod diameter allows shallow fastenings in thin concrete slabs or walls
- Productivity: use of optimum rod length and diameter saves time and money in each fastening job

#### Technical data

<b>Anchor type</b>	Off-the-shelf rods
<b>Head configuration</b>	Externally threaded
<b>Environmental conditions</b>	Indoor, damp conditions, Outdoor
<b>Type of fastening</b>	Pre-fastening, Through-fastening
<b>Material composition</b>	Steel, 5.8 grade, hot-dip galvanized (min. 43 µm)
<b>Installation direction</b>	All
<b>PROFIS</b>	Yes
<b>Material, corrosion</b>	Steel, sherardised / hot-dip galvanised
<b>In-service temperature - min.</b>	-40 °C
<b>Accessories</b>	HIT-CB



Ordering designation	Anchor size	Base plate clearance hole	Wrench size	Anchor length	Useable thread length	Sales pack quantity	Item number
HIT-V-F M10x95	M10	12 mm	17 mm	95 mm	78 mm	10 pc	409551
HIT-V-F M10x115	M10	12 mm	17 mm	115 mm	98 mm	10 pc	409552
HIT-V-F M10x130	M10	12 mm	17 mm	130 mm	113 mm	10 pc	409553
HIT-V-F M12x110	M12	14 mm	19 mm	110 mm	91 mm	10 pc	409555
HIT-V-F M12x120	M12	14 mm	19 mm	120 mm	101 mm	10 pc	409556
HIT-V-F M12x150	M12	14 mm	19 mm	150 mm	131 mm	10 pc	409557
HIT-V-F M16x150	M16	18 mm	24 mm	150 mm	127 mm	5 pc	409560
HIT-V-F M16x200	M16	18 mm	24 mm	200 mm	177 mm	5 pc	409561
HIT-V-F M16x300	M16	18 mm	24 mm	300 mm	277 mm	5 pc	409562
HIT-V-F M20x180	M20	22 mm	30 mm	180 mm	153 mm	5 pc	409564
HIT-V-F M20x260	M20	22 mm	30 mm	260 mm	233 mm	5 pc	409565
HIT-V-F M20x380	M20	22 mm	30 mm	380 mm	353 mm	10 pc	409566
HIT-V-F M20x480	M20	22 mm	30 mm	480 mm	453 mm	10 pc	409567
HIT-V-F M24x300	M24	26 mm	36 mm	300 mm	268 mm	5 pc	409568
HIT-V-F M24x450	M24	26 mm	36 mm	450 mm	418 mm	5 pc	409569

## Anchor rod (A4 stainless steel) HIT-V-R



### Key applications and advantages

- Suitable for fastenings in masonry in combination with Hilti HIT-HY 70
- Suitable for fastenings in concrete in combination with the relevant Hilti HIT injectable adhesive mortar
- Applications where embedment depth is 4x - 20x rod diameter
- Flexibility: approved embedment depth between 4 to 20 times rod diameter allows shallow fastenings in thin concrete slabs or walls
- Productivity: use of optimal rod length and diameter saves time and money with every fastening

### Technical data

<b>Anchor type</b>	Off-the-shelf rods
<b>Head configuration</b>	Externally threaded
<b>Environmental conditions</b>	Covered by ground soil, Outdoor, Underwater, fresh water
<b>Type of fastening</b>	Pre-fastening, Through-fastening
<b>Material composition</b>	Steel, A4 (SS316)
<b>Installation direction</b>	All
<b>PROFIS</b>	Yes
<b>Material, corrosion</b>	Steel, stainless
<b>In-service temperature - min.</b>	-40 °C
<b>Accessories</b>	HIT-CB



Ordering designation	Anchor size	Base plate clearance hole	Required tightening torque	Wrench size	Anchor length	Useable thread length	Drilling depth	Sales pack quantity	Item number
HIT-V-R M8x80	M8	9 mm	10 Nm	13 mm	80 mm	65 mm	60 mm	20 pc	387074
HIT-V-R M8x110	M8	9 mm	10 Nm	13 mm	110 mm	95 mm	80 mm	20 pc	387075
HIT-V-R M8x150	M8	9 mm	10 Nm	13 mm	150 mm	135 mm	80 mm	20 pc	387076
HIT-V-R M10x95	M10	12 mm	20 Nm	17 mm	95 mm	78 mm	90 mm	10 pc	387077
HIT-V-R M10x130	M10	12 mm	20 Nm	17 mm	130 mm	113 mm	90 mm	10 pc	387078
HIT-V-R M10x190	M10	12 mm	20 Nm	17 mm	190 mm	173 mm	90 mm	10 pc	387079
HIT-V-R M10x115	M10	12 mm	20 Nm	17 mm	115 mm	98 mm	80 mm	10 pc	387148
HIT-V-R M12x110	M12	14 mm	40 Nm	19 mm	110 mm	91 mm	110 mm	10 pc	387080
HIT-V-R M12x150	M12	14 mm	40 Nm	19 mm	150 mm	131 mm	110 mm	10 pc	387081
HIT-V-R M12x220	M12	14 mm	40 Nm	19 mm	220 mm	201 mm	110 mm	10 pc	387082
HIT-V-R M12x280	M12	14 mm	40 Nm	19 mm	280 mm	261 mm	110 mm	10 pc	387083
HIT-V-R M12x120	M12	14 mm	40 Nm	19 mm	120 mm	101 mm	90 mm	10 pc	387149
HIT-V-R M16x150	M16	18 mm	80 Nm	24 mm	150 mm	127 mm	125 mm	5 pc	387084
HIT-V-R M16x200	M16	18 mm	80 Nm	24 mm	200 mm	177 mm	125 mm	5 pc	387085
HIT-V-R M16x300	M16	18 mm	80 Nm	24 mm	300 mm	277 mm	125 mm	5 pc	387086
HIT-V-R M16x380	M16	18 mm	80 Nm	24 mm	380 mm	357 mm	125 mm	5 pc	387087
HIT-V-R M20x260	M20	22 mm	150 Nm	30 mm	260 mm	233 mm	170 mm	5 pc	387088
HIT-V-R M20x180	M20	22 mm	150 Nm	30 mm	180 mm	153 mm	170 mm	5 pc	387150
HIT-V-R M20x380	M20	22 mm	150 Nm	30 mm	380 mm	353 mm	170 mm	10 pc	387089
HIT-V-R M20x480	M20	22 mm	150 Nm	30 mm	480 mm	453 mm	170 mm	10 pc	387151
HIT-V-R M24x300	M24	26 mm	200 Nm	36 mm	300 mm	268 mm	210 mm	5 pc	387152
HIT-V-R M24x450	M24	26 mm	200 Nm	36 mm	450 mm	418 mm	210 mm	5 pc	387153



Technical data	
Anchor type	Metre rods
Head configuration	Externally threaded
Environmental conditions	Indoor, dry conditions
Type of fastening	Pre-fastening
Material composition	Steel, 8.8 grade, zinc-plated (min. 5 µm)
Installation direction	All
PROFIS	Yes
Material, corrosion	Steel, zinc-plated

**Key applications and advantages**

- Suitable for use with all Hilti HIT injectable mortars
- Covered by approval with confirmation of material and mechanical properties by inspection certificate 3.1
- Universality and productivity: lean inventory by enabling use of the same rod for various applications and lengths



**Anchor rod (8.8 carbon steel) AM**

Ordering designation	Anchor size	Base plate clearance hole	Wrench size	Anchor length	Sales pack quantity	Item number
AM8X1000 8.8 zined	M8	9 mm	13 mm	1000 mm	20 pc	407496
AM8x3000 8.8 zined	M8	9 mm	13 mm	3000 mm	20 pc	2008565
AM10X1000 8.8 zined	M10	12 mm	17 mm	1000 mm	20 pc	407497
AM10x3000 8.8 zined	M10	12 mm	17 mm	3000 mm	20 pc	2008566
AM12X1000 8.8 zined	M12	14 mm	19 mm	1000 mm	15 pc	407498
AM12x3000 8.8 zined	M12	14 mm	19 mm	3000 mm	15 pc	2008567
AM16X1000 8.8 zined	M16	18 mm	24 mm	1000 mm	5 pc	407499
AM16x3000 8.8 zined	M16	18 mm	24 mm	3000 mm	5 pc	2008568
AM20X1000 8.8 zined	M20	22 mm	30 mm	1000 mm	5 pc	407500
AM20x3000 8.8 zined	M20	22 mm	30 mm	3000 mm	5 pc	2008569
AM24X1000 8.8 zined	M24	26 mm	36 mm	1000 mm	5 pc	407501
AM24x3000 8.8 zined	M24	26 mm	36 mm	3000 mm	5 pc	2008580
AM27x1000 8.8 zined	M27	30 mm	41 mm	1000 mm	1 pc	2008138
AM27x3000 8.8 zined	M27	30 mm	41 mm	3000 mm	1 pc	2008333
AM30x1000 8.8 zined	M30	33 mm	46 mm	1000 mm	1 pc	2008139
AM30x3000 8.8 zined	M30	33 mm	46 mm	3000 mm	1 pc	2008334
AM33x1000 8.8 zined	M33	36 mm	50 mm	1000 mm	1 pc	2008330
AM33x3000 8.8 zined	M33	36 mm	50 mm	3000 mm	1 pc	2008335
AM36x1000 8.8 zined	M36	39 mm	55 mm	1000 mm	1 pc	2008331
AM36x3000 8.8 zined	M36	39 mm	55 mm	3000 mm	1 pc	2008336
AM39x1000 8.8 zined	M39	42 mm	60 mm	1000 mm	1 pc	2008332
AM39x3000 8.8 zined	M39	42 mm	60 mm	3000 mm	1 pc	2008337

Anchor Systems

**Anchor rod (8.8 hot-dip galvanized) AM 8.8 HDG**



Key applications and advantages	
■	Suitable for use with all Hilti HIT injectable mortars

Technical data	
Anchor type	Metre rods
Head configuration	Externally threaded
Environmental conditions	Indoor, damp conditions, Outdoor
Type of fastening	Pre-fastening
Material composition	Steel, 8.8 grade, hot-dip galvanized (min. 43 µm)
Installation direction	All
PROFIS	Yes
Material, corrosion	Steel, sherardised / hot-dip galvanized



Ordering designation	Anchor size	Base plate clearance hole	Wrench size	Anchor length	Sales pack quantity	Item number
AM10x1000 8.8 HDG	M10	12 mm	17 mm	1000 mm	20 pc	419102
AM10x3000 8.8 HDG	M10	12 mm	17 mm	3000 mm	20 pc	2008581
AM12x1000 8.8 HDG	M12	14 mm	19 mm	1000 mm	15 pc	419103
AM16x1000 8.8 HDG	M16	18 mm	24 mm	1000 mm	5 pc	419104

Ordering designation	Anchor size	Base plate clearance hole	Wrench size	Anchor length	Sales pack quantity	Item number
AM20x1000 8.8 HDG	M20	22 mm	30 mm	1000 mm	5 pc	419105
AM24x1000 8.8 HDG	M24	26 mm	36 mm	1000 mm	5 pc	419106
AM24x3000 8.8 HDG	M24	26 mm	36 mm	3000 mm	5 pc	2008585
AM27x1000 8.8 HDG	M27	30 mm	41 mm	1000 mm	1 pc	2008338
AM30x1000 8.8 HDG	M30	33 mm	46 mm	1000 mm	1 pc	2008339
AM33x1000 8.8 HDG	M33	36 mm	50 mm	1000 mm	1 pc	2008340
AM33x3000 8.8 HDG	M33	36 mm	50 mm	3000 mm	1 pc	2008344
AM36x1000 8.8 HDG	M36	39 mm	55 mm	1000 mm	1 pc	2008341

## Composite mesh sleeve HIT-SC

### Key applications and advantages

- Suitable for applications in hollow base materials in combination with Hilti HIT-HY 70, HIT-MM PLUS or HFX
- Typical applications include sun blinds, awnings, electrical installations, sanitary installations, handrails, banisters, railings, window gratings, gates
- Standard 50 mm and 85 mm lengths can be used individually or clicked together for deeper embedment applications
- Simply push the anchor rod into the sleeve

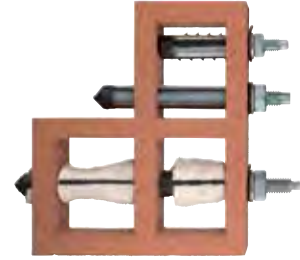

Ordering designation	Anchor size	Outside diameter	Anchor length	Drilling depth	Sales pack quantity	Item number
HIT-SC 16x50	8/10 mm	18 mm	50 mm	60 mm	20 pc	375981
HIT-SC 16x85	8/10 mm	18 mm	85 mm	95 mm	20 pc	375982
HIT-SC 12x50	6 mm	14 mm	50 mm	60 mm	20 pc	375979
HIT-SC 12x85	6 mm	14 mm	85 mm	95 mm	20 pc	375980
HIT-SC 22x85	16 mm	24 mm	85 mm	95 mm	10 pc	284511

# Technical software and literature

## Profis Anchor - the new and easy design software from Hilti



Hilti has now released PROFIS Anchor – a completely revised version of its anchor design PC application. This new software makes it quicker and easier than ever to make calculations and select the appropriate anchor.

### Extremely easy to use

PROFIS Anchor is self-explanatory and can thus be used productively within a very short time.

### Individual solutions

PROFIS Anchor includes a wide selection of predefined anchor plates, or the option to design your own.

### Download free of charge

Hilti's new PROFIS Anchor anchor design software can be downloaded, free of charge, from [www.hilti.co.uk](http://www.hilti.co.uk) or [www.hilti.ie](http://www.hilti.ie). We notify users of all updates which are available to download immediately.

### Up to date

The technical data on which PROFIS Anchor is based on the latest European Technical Approvals for anchoring.

### Anchor Selector App

- Anchor selection at your fingertips
- Links to Hilti Online, Customer Services and directions to the nearest Hilti Centre



The new Hilti Anchors Selector App now available for iPhone and Android phones



### Fastening Technology Manual

- For manual anchor calculations
- Available free-of-charge to download from the Hilti Technical Library



For complete Anchor setting instructions and Anchor design data.

### Adhesive Anchor Volume Calculator

- For manual anchor calculations





Technical data	
Dispenser, setting tool, accessory, tester type	Dispensers
Battery type	22 V
Dispenser type	Battery
Power source type	Compact B22/1.6 or B22/3.3 battery

**Key applications and advantages**

- Injection of Hilti HIT adhesive mortar for fastening anchor rods and rebars in concrete and masonry
- No need for an external power source
- Serial fastenings and/or injection in deep drilled holes
- Easy injection even at low temperatures
- Dose adjustment knob for accurate, controlled dispensing



**Cordless electric dispenser HDE 500-A22**



Ordering designation	Weight	Sales pack quantity	Item number
HDE 500-A22 box	2.2 kg	1 pc	2005630
HDE 500-A22 CR/CB cas	2.2 kg	1 pc	2005637

**HDM manual dispenser HDM**



- Key applications and advantages**
- Fast, easy foil pack loading
  - Ruggedly built to withstand tough job-site conditions

Technical data	
Dispenser, setting tool, accessory, tester type	Dispensers
Dispenser type	Manual

Ordering designation	Weight	Sales pack quantity	Item number
HDM 500 box	1.8 kg	1 pc	2005641

**Accessories for blowing out drilled holes Hilti HIT**



- Key applications and advantages**
- For fast and efficient removal of dust and debris from drilled holes of varying diameters and depths to allow correct installation of anchors and rebar

Technical data	
Dispenser, setting tool, accessory, tester type	Cleaning accessories

Ordering designation	Sales pack quantity	Item number
Connecting piece HIT-DL V10/1	1 pc	336644
Blow-out gun G 1/4"	1 pc	381215
Blow-out pump	1 pc	60579
Extension tube HIT-VL 16/0.7	10 pc	336646

### Cartridge holder HIT-CB 500

**Key applications and advantages**

- For use with all Hilti 3:1 adhesive foils



Ordering designation	Sales pack quantity	Item number
Cartridge holder HIT-CB 500	1 pc	2007057

### Cartridge holder Hilti HIT-CR

**Key applications and advantages**

- For use with 5:1 red cartridges (e.g. Hilti HIT-HY 200) HIT-HY 200)



Ordering designation	Sales pack quantity	Item number
Cartridge holder HIT-CR 500	1 pc	2007059

### Mixers and extensions Hilti HIT

**Key applications and advantages**

- Mixing nozzles for Hilti HIT adhesive cartridges



Ordering designation	Sales pack quantity	Item number
Mixer HIT-RE-M	1 pc	337111
Mixer HIT-M1 assy	100 pc	68156

### Accessory sets HIT Profi

**Key applications and advantages**

- Premium rebar set for hole diameters up to 32 mm and depths up to 2500 mm
- Profi rebar set for hole diameters up to 25 mm and depths up to 800 mm
- Profi anchor set for hole diameters up to 24 mm and depths up to 250 mm
- Reliable installation to help achieve maximum loadbearing capacity in challenging rebar and anchor applications
- Convenient and efficient installation of rebar and anchors in virtually all working directions and drilled hole conditions



Ordering designation	Sales pack quantity	Item number
Accessory kit Hit Premium Rebar cas	1 pc	2036986
Accessory kit Hit Profi Rebar box	1 pc	2036987
Accessory kit HIT PROFI anchor sys.	1 pc	2036988
Accessory kit Hit Premium Rebar cas	1 pc	2036989
Accessory kit Hit Profi Rebar box	1 pc	2036990
Accessory kit Hit Profi Anchor box	1 pc	2036991

Anchor Systems



**Technical data**

<b>Dispenser, setting tool, accessory, tester type</b>	Anchor testers and accessories
--	--------------------------------

**Key applications and advantages**

- Proof loading: application of specific test loads to anchors set in various materials
- Pull-out tests: Determination of pull-out resistance of anchors and DX fasteners in the test lab or on site
- Testing hoist anchor points in elevator shafts
- Compact and easy-to-use
- Test load can be read directly from the gauge

**Tensile testing system HAT 28**

Ordering designation	Gauge	Gauge accuracy	Maximum test load	Effective span of load-spreading bridge	Maximum tensile stroke	Weight incl. bridge assy.	Sales pack quantity	Item number
<b>HAT 28 M kit</b>	Strain gauge 0-5 kN/0-25 kN with max. load indicator	± 2.5%	25 kN	118 mm	50 mm	4 kg	1 pc	<b>355338</b>
<b>HAT 28 B kit</b>	Strain gauge 0-20 kN with maximum load indicator	± 2.5%	20 kN	118 mm	50 mm	4 kg	1 pc	<b>355337</b>
<b>HAT 28 S kit</b>	Strain gauge 0-20 kN with maximum load indicator	± 2.5%	20 kN	118 mm	50 mm	4 kg	1 pc	<b>355339</b>
<b>HAT 28 elevator</b>	Strain gauge 0-30 kN with maximum load indicator	± 2.5%	30 kN	207 mm	51 mm	4 kg	1 pc	<b>386372</b>
<b>HAT 28 M6 kit</b>	Strain gauge 0-5 kN with maximum load indicator	± 2.5%	5 kN				1 pc	<b>236442</b>



Technical data	
<b>Dispenser, setting tool, accessory, tester type</b>	Anchor testers and accessories
<b>Battery type</b>	1 x 9 V
<b>Power source type</b>	9 V battery

**Key applications and advantages**

- Proof loading: application of specific test loads to anchors set in various materials
- Compact and easy-to-use digital tester powered by a 9V battery
- Loads can be read directly from the digital gauge

**Anchor testing tool DPG 100**



Ordering designation	Gauge	Gauge accuracy	Maximum test load	Max. allowable load	Weight	Sales pack quantity	Item number
DPG 100	Digital display	Typical accuracy of ± 0.3 kN	100 kN	100 kN	3 kg	1 pc	59999

**Elevator hoist anchor point HAP**



- Key applications and advantages**
- Designed for load or personnel lifting applications with manual or motorized hoists during the installation or maintenance of elevators in elevator shafts
  - No limitations in terms of load directions, also works on walls
  - HAP 1.15 designed for use with standard HST M12 or KB-TZ 1/2" anchors

Technical data	
<b>Dispenser, setting tool, accessory, tester type</b>	Hoist anchor points

Ordering designation	Sales pack quantity	Item number
HAP 1.15	2 pc	2032179

Anchor Systems

**Technical data**

Dispenser, setting tool, accessory, tester type	Setting tools
---	---------------

**Key applications and advantages**

- Setting tool for installing HAS and HAS-TZ rods

**Setting tool TE-C HEX, TE-Y HEX**

Ordering designation	Connection end	Sales pack quantity	Item number
TE-C HEX M10	TE-C	1 pc	311415
TE-C HEX M12	TE-C	1 pc	311416
TE-C HEX M16	TE-C	1 pc	311417
TE-Y HEX M20	TE-Y	1 pc	336420

**Setting tool TE-C-E**

**Key applications and advantages**

- Setting tool for installing HAS-E
- Setting tool for installing HAS-E

**Technical data**

Dispenser, setting tool, accessory, tester type	Setting tools
---	---------------

Ordering designation	Connection end	Sales pack quantity	Item number
TE-C-E M8	TE-C	1 pc	369223
TE-C-E M10	TE-C	1 pc	369224
TE-C-E M12	TE-C	1 pc	369225
TE-C-E M16	TE-C	1 pc	369226

**Setting tool TE-Y-E**

**Key applications and advantages**

- Required for setting the HAS-E
- Setting tool for installing HAS-E

**Technical data**

Dispenser, setting tool, accessory, tester type	Setting tools
---	---------------

Ordering designation	Connection end	Sales pack quantity	Item number
TE-Y-E M16	TE-Y	1 pc	369227
TE-Y-E M20	TE-Y	1 pc	369228
TE-Y-E M24	TE-Y	1 pc	369229

**Setting tool HIS-S**

**Key applications and advantages**

- Setting tool for installing HIS
- Setting tool for installing HIS

**Technical data**

Dispenser, setting tool, accessory, tester type	Setting tools
---	---------------

Ordering designation	Sales pack quantity	Item number
HIS-S M8	1 pc	45964
HIS-S M10	1 pc	45965
HIS-S M12	1 pc	45966
HIS-S M16	1 pc	45967
HIS-S M20	1 pc	45968

### Torque bar S-TB



#### Key applications and advantages

- For setting HSA stud anchors with maximum accuracy and productivity
- Reliable ETA approved system using SIW 14-A, 22-A or 22T-A impact wrench
- No more over or undertorquing of HSA stud anchors

#### Technical data

<b>Base material</b>	Concrete (uncracked)
<b>Connection end size</b>	12.7 mm
<b>Drive connection</b>	1/2 in square, female
<b>Drive head</b>	1/2 in, square, male
<b>Material coating/plating/finish</b>	Black
<b>Material composition</b>	Impact-grade chrome molybdenum steel
<b>Tool type</b>	Impact tools, SIW

Ordering designation	Weight	Sales pack quantity	Item number
S-TB HSA M8	0.11 kg	1 pc	423774
S-TB HSA M10	0.12 kg	1 pc	423775
S-TB HSA M12	0.12 kg	1 pc	423776
S-TB HSA M16	0.13 kg	1 pc	423777

### Setting tool HKD-TE-CX (short)



#### Key applications and advantages

- Installation of the Hilti HKD short drop-in anchor for fastening pipes, air ducts and suspended ceilings
- Installation of the HKD short drop-in anchor
- Holes always drilled to the correct depth
- 25 mm anchor length reduces the risk of rebar hits when drilling

#### Technical data

<b>Working length</b>	27 mm
<b>Tool type</b>	All TE-C tools
<b>Insert connection end</b>	TE-C (SDS-plus)



SDS plus

Ordering designation	Diameter	Length	Sales pack quantity	Item number
HKD-TE-CX M6 1/4"x25	8 mm	142 mm	1 pc	414472
HKD-TE-CX M8x25	10 mm	162 mm	1 pc	414475
HKD-TE-CX M10x25	12 mm	162 mm	1 pc	414480
HKD-TE-CX M12x25	15 mm	200 mm	1 pc	2097386

### Machine setting tool for flush anchors HSD-M



#### Key applications and advantages

- Automatic machine setting tool for more productive installation of Hilti drop-in anchors

#### Technical data

<b>Dispenser, setting tool, accessory, tester type</b>	Setting tools
--	---------------

Ordering designation	Sales pack quantity	Item number
Setting tool HSD-M M6 1/4"X25	1 pc	243746
Setting tool HSD-M M8 5/16"X30	1 pc	243748
Setting tool HSD-M M8 5/16"X40	1 pc	243749
Setting tool HSD-M M10 3/8"X30	1 pc	243750
Setting tool HSD-M M10 3/8"X40	1 pc	243751
Setting tool HSD-M M12 1/2"X50	1 pc	243752
Setting tool HSD-M M16 5/8"X65	1 pc	243753
Setting tool HSD-M M20 3/4"X80	1 pc	243754
Setting tool HSD-M M12x25	1 pc	401553

### Manual setting tool with hand guard, for flush anchors HSD-G



#### Key applications and advantages

- HSD-G setting tool for the HDI-P features a hand guard for added user safety

#### Technical data

<b>Dispenser, setting tool, accessory, tester type</b>	Setting tools
--	---------------

Ordering designation	Sales pack quantity	Item number
Setting tool HSD-G M10 3/8"x30	1 pc	230935
Setting tool HSD-G M6 1/4"x25	1 pc	243738
Setting tool HSD-G M8 5/16"x30	1 pc	243740
Setting tool HSD-G M8 5/16"x40	1 pc	243741
Setting tool HSD-G M10 3/8"x40	1 pc	243742
Setting tool HSD-G M12 1/2"x50	1 pc	243743
Setting tool HSD-G M16 5/8"x65	1 pc	243744
Setting tool HSD-G M20 3/4"x80	1 pc	243745
Setting tool HSD-G M6 1/4"x25/30	1 pc	257621
Setting tool HSD-G M12x25	1 pc	401552

### Eye protection for general use Safety glasses / goggles



#### Key applications and advantages

- Optimal eye coverage and wrap-around protection
- High-impact resistant polycarbonate lenses, additional curvature at the upper edge providing an integrated brow guard

Ordering designation	Additional accessory information	Height	Length	Weight	Sales pack quantity	Item number
Safety glasses PP EY-CA NCH clear	Lens: PC material, thickness 2.1 mm, Optidur NCH coating, filter: 2C-1.2, impact energy: 45m/s	6 mm	15 mm	0.04 kg	1 pc	2065449
Goggles PP EY-HA S clear	Lens: PC material, thickness 2.1 mm, Supravision Extreme coating, filter: 2-1.2, impact energy: 120m/s, surface resistance to fine particles: K, antifog: N	6 mm	15 mm	0.04 kg	1 pc	2065590
Safety glasses PP EY-GU C HC/AF clear	Lens: PC material, thickness 2.1 mm, Supravision HC-AF coating, filter: 2C-1.2, impact energy: 45m/s, surface resistance to fine particles: K, antifog: N	5 mm	15 mm	0.03 kg	1 pc	2065445
Safety glasses PP EY-GU G HC/AF grey	Lens: PC material, thickness 2.1 mm, Supravision HC-AF coating, filter: 2C-1.2, impact energy: 45m/s, surface resistance to fine particles: K, antifog: N	5 mm	15 mm	0.03 kg	1 pc	2065446
Safety glasses PP EY-GU B AF blue	Lens: PC material, thickness 2.1 mm, Supravision HC-AF coating, filter: 2C-1.2, impact energy: 45m/s, surface resistance to fine particles: K, antifog: N	5 mm	15 mm	0.03 kg	1 pc	2065447
Goggles PP EY-HA R HC/AF clear	Lens: PC material, thickness 2.2 mm, Supravision HC-AF coating, filter 2-1.2, impact energy 120m/s, surface resistance to fine particles: K, antifog: N	8 mm	18 mm	0.08 kg	1 pc	2065591

**Setting tools for HAS-E and HIS-N**

**Diameters M8 to M16**



**Diameters M20 to M24**



**Diameters M27 to M39**

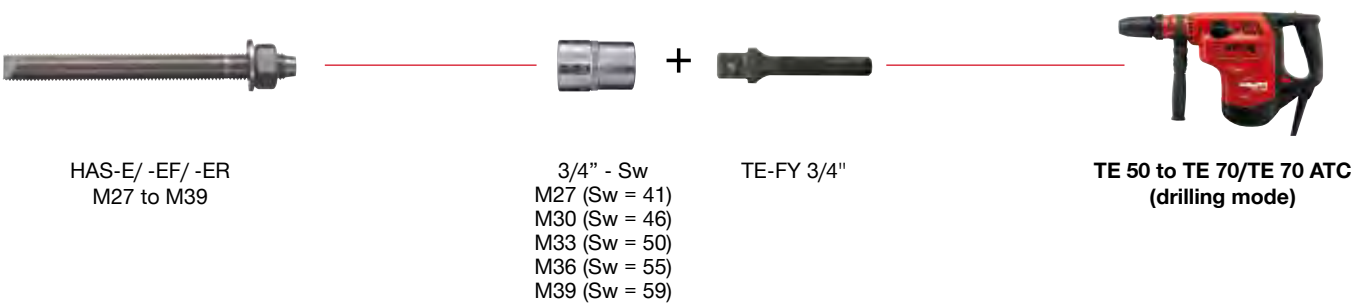

Anchor Systems

**Setting tools for HIS-N/RN M8 to M20**

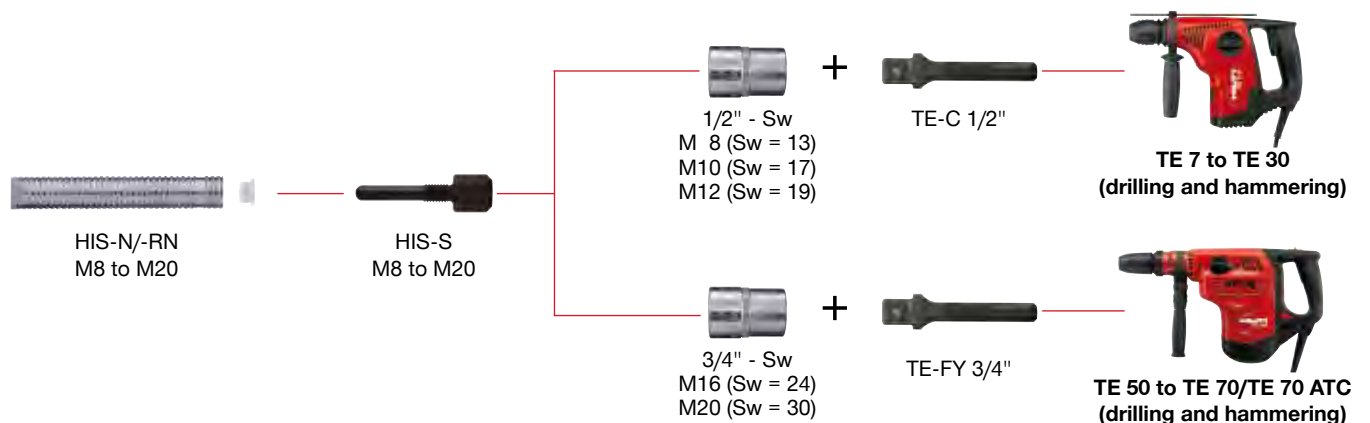

## Carbon steel through-set undercut anchor HDA-T



### Key applications and advantages

- Safety-relevant, heavy-duty fastenings for all dynamic loading (shock, seismic and fatigue) in cracked or uncracked concrete, including applications in nuclear power plants
- Fastenings to support heavy pipes, safety barriers, industrial machines, crane rails, dorm structures, crash barriers, roof fixings, elevator tracks, bridge retrofitting etc.
- Combines the advantages of a post-installed mechanical anchor, i.e. flexibility and immediate loading, with the performance of a cast-in-place headed stud
- Close spacing and small edge distance thanks to low expansion forces

### Technical data

<b>Head configuration</b>	Externally threaded
<b>Environmental conditions</b>	Indoor, dry conditions
<b>Type of fastening</b>	Through-fastening
<b>Material composition</b>	Bolt: steel, 8.8 grade, zinc-plated (min. 5 µm)
<b>Installation direction</b>	All
<b>IBC compliance</b>	IBC 2003, IBC 2006, IBC 2009, IBC 2012



### Approvals

ETA	ETA 99/0009 for HDA self-cutting undercut anchor (ETAG 001-03, Option 1)
ICC-ES report (concrete)	ICC-ES ESR-1546 for HDA self-cutting undercut anchor

Approvals and test reports may apply to selected products only. Please refer to the documents for details.



Ordering designation	Anchor size	Base plate clearance hole	Required tightening torque	Socket size	Wrench size	Washer size	Anchor length	Sales pack quantity	Item number
HDA-T M10x100/20	M10	21 mm	50 Nm	17 mm	17 mm	27 mm	150 mm	12 pc	331545
HDA-T M12x125/50	M12	23 mm	80 Nm		19 mm	32 mm	210 mm	8 pc	331549
HDA-T M16x190/40	M16	32 mm	120 Nm		24 mm	45 mm	275 mm	4 pc	331552
HDA-T M16x190/60	M16	32 mm	120 Nm		24 mm	45 mm	295 mm	4 pc	331553
HDA-T M20x250/50	M20	40 mm	300 Nm		30 mm	50 mm	360 mm	2 pc	339267
HDA-T M20x250/100	M20	40 mm	300 Nm		30 mm	50 mm	410 mm	2 pc	339268

## Through-set undercut anchor system (sherardized) HDA-TF



### Key applications and advantages

- Safety-relevant, heavy-duty fastenings for all dynamic loading in cracked or uncracked concrete, including applications in nuclear power plants
- Examples: supports for heavy pipes, safety barriers, industrial machines, crane rails, dorm structures, crash barriers, roof fastening points, elevator tracks, bridge retrofitting etc.
- Combines the advantages of a post-installed mechanical anchor, i.e. flexibility and immediate loading, with the performance of a cast-in-place headed stud
- Close spacing and small edge distances thanks to very low expansion forces

### Technical data

<b>Head configuration</b>	Externally threaded
<b>Environmental conditions</b>	Indoor, damp conditions
<b>Type of fastening</b>	Through-fastening
<b>Material composition</b>	Bolt: steel, 8.8 grade, sherardized (min. 45 µm)
<b>Installation direction</b>	All
<b>PROFIS</b>	Yes
<b>LEED information available</b>	Yes
<b>Additional product information</b>	Installation requires a specific stop drill bit, setting tool and rotary hammer as per instructions
<b>Material, corrosion</b>	Steel, sherardised / hot-dip galvanised
<b>Accessories</b>	HDA-CW



Ordering designation	Anchor size	Base plate clearance hole	Required tightening torque	Wrench size	Washer size	Anchor length	Length identification mark	Sales pack quantity	Item number
HDA-TF M16x190/40	M16	32 mm	120 Nm	24 mm	45 mm	275 mm	R	4 pc	339364
HDA-TF M16x190/60	M16	32 mm	120 Nm	24 mm	45 mm	295 mm	S	4 pc	339365

### Stainless steel through-set undercut anchor HDA-TR



#### Key applications and advantages

- Safety-relevant, heavy-duty fastening for dynamic loading in cracked or uncracked concrete and corrosive environments, including applications in nuclear power plants
- Anchoring supports for heavy pipes, safety barriers, industrial machines, crane rails, dorm structures, crash barriers, roof fixings, elevator tracks, bridge retrofitting etc.
- Combines the advantages of a post-installed mechanical anchor, i.e. flexibility and immediate loading, with the performance of a cast-in-place headed stud
- Close spacing and small edge distance because of low expansion forces

#### Technical data

<b>Head configuration</b>	Externally threaded
<b>Environmental conditions</b>	Outdoor
<b>Type of fastening</b>	Through-fastening
<b>Material composition</b>	Steel, A4 (SS316)
<b>Installation direction</b>	All
<b>IBC compliance</b>	IBC 2003, IBC 2006, IBC 2009, IBC 2012
<b>PROFIS</b>	Yes
<b>LEED information available</b>	Yes
<b>Additional product information</b>	Meets approval requirements when installed using the specified stop drill bit, setting tool and rotary hammer
<b>Material, corrosion</b>	Steel, stainless

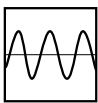

Ordering designation	Anchor size	Base plate clearance hole	Required tightening torque	Wrench size	Washer size	Anchor length	Length identification mark	Sales pack quantity	Item number
HDA-TR M10x100/20	M10	21 mm	50 Nm	17 mm	27 mm	150 mm	I	12 pc	339351
HDA-TR M12x125/30	M12	23 mm	80 Nm	19 mm	32 mm	190 mm	L	8 pc	339352
HDA-TR M16x190/40	M16	32 mm	120 Nm	24 mm	45 mm	275 mm	R	4 pc	339354
HDA-TR M16x190/60	M16	32 mm	120 Nm	24 mm	45 mm	295 mm	S	4 pc	339355

### Carbon steel pre-set undercut anchor HDA-P



#### Key applications and advantages

- Safety-relevant, heavy-duty fastenings for all dynamic loading (shock, seismic and fatigue) in cracked or uncracked concrete, including applications in nuclear power plants
- Fastenings to support heavy pipes, safety barriers, industrial machines, crane rails, dorm structures, crash barriers, roof fixings, elevator tracks, bridge retrofitting etc.
- Combines the flexibility and immediate loading capability of a post-installed mechanical anchor with the performance of a cast-in-place headed stud
- Close spacing and small edge distance thanks to low expansion forces

#### Technical data

<b>Head configuration</b>	Externally threaded
<b>Environmental conditions</b>	Indoor, dry conditions
<b>Type of fastening</b>	Pre-fastening
<b>Material composition</b>	Bolt: steel, 8.8 grade, zinc-plated (min. 5 µm)
<b>Installation direction</b>	All
<b>IBC compliance</b>	IBC 2003, IBC 2006, IBC 2009, IBC 2012
<b>PROFIS</b>	Yes
<b>LEED information available</b>	Yes
<b>Additional product information</b>	Meets approval requirements when installed using the specified stop drill bit, setting tool and rotary hammer
<b>Material, corrosion</b>	Steel, zinc-plated

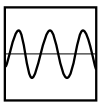

Ordering designation	Anchor size	Base plate clearance hole	Required tightening torque	Wrench size	Washer size	Anchor length	Length identification mark	Sales pack quantity	Item number
HDA-P M10x100/20	M10	12 mm	50 Nm	17 mm	27 mm	150 mm	I	12 pc	331544
HDA-P M12x125/30	M12	14 mm	80 Nm	19 mm	32 mm	190 mm	L	8 pc	331546
HDA-P M12x125/50	M12	14 mm	80 Nm	19 mm	32 mm	210 mm	N	8 pc	331547
HDA-P M16x190/40	M16	18 mm	120 Nm	24 mm	45 mm	275 mm	R	4 pc	331550
HDA-P M16x190/60	M16	18 mm	120 Nm	24 mm	45 mm	295 mm	S	4 pc	331551
HDA-P M20x250/50	M20	22 mm	300 Nm	30 mm	50 mm	360 mm	V	2 pc	339265
HDA-P M20x250/100	M20	22 mm	300 Nm	30 mm	50 mm	410 mm	X	2 pc	339266



## Pre-set undercut anchor (sherardized) HDA-PF



### Key applications and advantages

- Safety-relevant, heavy-duty fastenings for dynamic loading in cracked or uncracked concrete, including applications in nuclear power plants
- Examples: supports for heavy pipes, safety barriers, industrial machines, crane rails, dorm structures, crash barriers, roof fastening points, elevator tracks, bridge retrofitting etc.
- Combines the advantages of a post-installed mechanical anchor, i.e. flexibility and immediate loading, with the performance of a cast-in-place headed stud
- Close spacing and small edge distances thanks to very low expansion forces

### Technical data

<b>Head configuration</b>	Externally threaded
<b>Environmental conditions</b>	Indoor, damp conditions
<b>Type of fastening</b>	Pre-fastening
<b>Material composition</b>	Bolt: steel, 8.8 grade, sherardized (min. 45 µm)
<b>Installation direction</b>	All
<b>PROFIS</b>	Yes
<b>LEED information available</b>	Yes
<b>Additional product information</b>	Installation requires a specific stop drill bit, setting tool and rotary hammer as per instructions
<b>Material, corrosion</b>	Steel, sherardised / hot-dip galvanised
<b>Required inserts</b>	TE-C-HDA-B, TE-Y-HDA-ST, TE-Y-HDA-B, TE-C-HDA-ST, TE-C-HDA-RT, TE-C-HDA-GT



Ordering designation	Anchor size	Base plate clearance hole	Required tightening torque	Wrench size	Washer size	Anchor length	Length identification mark	Sales pack quantity	Item number
HDA-PF M10x100/20	M10	12 mm	50 Nm	17 mm	27 mm	150 mm	I	12 pc	412900
HDA-PF M12x125/30	M12	14 mm	80 Nm	19 mm	32 mm	190 mm	L	8 pc	412901
HDA-PF M12x125/50	M12	14 mm	80 Nm	19 mm	32 mm	210 mm	N	8 pc	412902
HDA-PF M16x190/40	M16	18 mm	120 Nm	24 mm	45 mm	275 mm	R	4 pc	339359
HDA-PF M16x190/60	M16	18 mm	120 Nm	24 mm	45 mm	295 mm	S	4 pc	339360

## Stainless steel pre-set undercut anchor HDA-PR



### Key applications and advantages

- Safety-relevant, heavy-duty fastening for dynamic loading in cracked or uncracked concrete and corrosive environments, including applications in nuclear power plants
- Anchoring supports for heavy pipes, safety barriers, industrial machines, crane rails, dorm structures, crash barriers, roof fixings, elevator tracks, bridge retrofitting etc.
- Combines the flexibility and immediate loading of a post-installed mechanical anchor with the performance of a cast-in-place headed stud
- Close spacing and small edge distances thanks to low expansion forces

### Technical data

<b>Head configuration</b>	Externally threaded
<b>Environmental conditions</b>	Outdoor
<b>Type of fastening</b>	Pre-fastening
<b>Material composition</b>	Steel, A4 (SS316)
<b>Installation direction</b>	All
<b>IBC compliance</b>	IBC 2003, IBC 2006, IBC 2009, IBC 2012
<b>PROFIS</b>	Yes
<b>LEED information available</b>	Yes
<b>Additional product information</b>	Meets approval requirements when installed using the specified stop drill bit, setting tool and rotary hammer
<b>Material, corrosion</b>	Steel, stainless

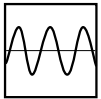

Ordering designation	Anchor size	Base plate clearance hole	Required tightening torque	Wrench size	Washer size	Anchor length	Length identification mark	Sales pack quantity	Item number
HDA-PR M10x100/20	M10	12 mm	50 Nm	17 mm	27 mm	150 mm	I	12 pc	339346
HDA-PR M12x125/30	M12	14 mm	80 Nm	19 mm	32 mm	190 mm	L	8 pc	339347
HDA-PR M12x125/50	M12	14 mm	80 Nm	19 mm	32 mm	210 mm	N	8 pc	339348
HDA-PR M16x190/40	M16	18 mm	120 Nm	24 mm	45 mm	275 mm	R	4 pc	339349
HDA-PR M16x190/60	M16	18 mm	120 Nm	24 mm	45 mm	295 mm	S	4 pc	339350

### Stop drill bit TE-C-HDA-B



#### Key applications and advantages

- Special drill bit required for drilling HDA anchor holes with defined drilling depth

#### Technical data

<b>Dispenser, setting tool, accessory, tester type</b>	Stop drill bits
--	-----------------



SDS plus

Ordering designation	Connection end	Sales pack quantity	Item number
TE-C-HDA-B 20x100	TE-C	1 pc	332089
TE-C-HDA-B 20x120	TE-C	1 pc	332090
TE-C-HDA-B 22x125	TE-C	1 pc	402050
TE-C-HDA-B 22x155	TE-C	1 pc	402056
TE-C-HDA-B 22x175	TE-C	1 pc	402060

### Stop drill bit TE-Y-HDA-B



#### Key applications and advantages

- Drilling HDA anchor holes to a defined depth

#### Technical data

<b>Dispenser, setting tool, accessory, tester type</b>	Stop drill bits
--	-----------------



SDS max

Ordering designation	Connection end	Sales pack quantity	Item number
TE-Y-HDA-B 30x190	TE-Y	1 pc	332097
TE-Y-HDA-B 30x230	TE-Y	1 pc	332098
TE-Y-HDA-B 30x250	TE-Y	1 pc	332099
TE-Y-HDA-B 37x250	TE-Y	1 pc	339270
TE-Y-HDA-B 37x300	TE-Y	1 pc	339271
TE-Y-HDA-B 37x350	TE-Y	1 pc	339272
TE-Y-HDA-B 22x175	TE-Y	1 pc	402062

### Setting tool TE-C-HDA-ST



#### Key applications and advantages

- Required for the automatic self-undercutting operation with the HDA undercut anchor

#### Technical data

<b>Dispenser, setting tool, accessory, tester type</b>	Setting tools
--	---------------



SDS plus

Ordering designation	Connection end	Sales pack quantity	Item number
TE-C-HDA-ST 20-M10	TE-C	1 pc	331843
TE-C-HDA-ST22-M12	TE-C	1 pc	331844

### Setting tool TE-Y-HDA-ST



#### Key applications and advantages

- Required for the automatic self-undercutting operation with the HDA undercut anchor

#### Technical data

<b>Dispenser, setting tool, accessory, tester type</b>	Setting tools
--	---------------



SDS max

Ordering designation	Connection end	Sales pack quantity	Item number
TE-Y-HDA-ST 22-M12	TE-Y	1 pc	287134
TE-Y-HDA ST 30-M16	TE-Y	1 pc	331846
TE-Y-HDA-ST 37-M20	TE-Y	1 pc	339269

## Grinding tool TE-C-HDA-GT



### Key applications and advantages

- Manual undercutting tool for the installation of HDA undercut anchors in the event of hitting rebars

### Technical data

Dispenser, setting tool, accessory, tester type

Undercut tools



SDS plus

Ordering designation	Connection end	Sales pack quantity	Item number
HDA-GB 22		1 pc	333446
HDA-GB 30		1 pc	333447
TE-C-HDA-GT 22	TE-C	1 pc	333440
TE-C-HDA-GT 30	TE-C	1 pc	333441

## Removal tool TE-C-HDA-RT



### Key applications and advantages

- Removing HDA undercut anchors
- Easy and fast removal process
- Anchor will be completely removed, no steel part left in the concrete

### Technical data

Dispenser, setting tool, accessory, tester type

Other accessories



SDS plus

Ordering designation	Sales pack quantity	Item number
TE-C-HDA-RT 22-M12	1 pc	333434
TE-C-HDA-RT 30-M16	1 pc	333435
TE-C-HDA-RT 37-M20	1 pc	339273



**Key applications and advantages**

- Safety-relevant, medium-duty fastenings in cracked or uncracked concrete, especially where shallow embedment and/or small edge distance or close spacing is required
- Examples: stair hand rails, sprinkler pipes, air ducts, seating, facade substructures, car park barriers, etc.
- Shallow embedment depth for thin concrete slabs or where permissible drilling depth is limited
- Combines high working loads with small edge distances and close spacing thanks to very low expansion forces

Technical data	
<b>Head configuration</b>	Externally threaded
<b>Environmental conditions</b>	Indoor, dry conditions
<b>Type of fastening</b>	Pre-fastening
<b>Material composition</b>	Bolt: steel, 8.8 grade, zinc-plated (min. 5 µm)
<b>Installation direction</b>	All
<b>PROFIS</b>	Yes
<b>LEED information available</b>	Yes
<b>Additional product information</b>	Meets approval requirements when installed using the specified stop drill bit, setting tool and rotary hammer
<b>Material, corrosion</b>	Steel, zinc-plated
<b>Required inserts</b>	TE-C-HSC-MW, TE-C-HSC-B



**Safety anchor (carbon steel) HSC-A**



Ordering designation	Anchor size	Base plate clearance hole	Required tightening torque	Wrench size	Anchor length	Length identification mark	Max. fixture thickness at standard embedment depth	Sales pack quantity	Item number
HSC-A M8x40/15	M8	9 mm	10 Nm	13 mm	72 mm	Two notches at end of anchor sleeve	15 mm	25 pc	31139
HSC-A M8x50/15	M8	9 mm	10 Nm	13 mm	82 mm	No notch at end of anchor sleeve	15 mm	25 pc	31141
HSC-A M10x40/20	M10	12 mm	20 Nm	17 mm	80 mm	Two notches at end of anchor sleeve	20 mm	25 pc	31140
HSC-A M12x60/20	M12	14 mm	30 Nm	19 mm	104 mm	Three notches at end of anchor sleeve	20 mm	20 pc	15507

**Safety anchor (stainless steel) HSC-AR**



Key applications and advantages	
■	Safety-relevant, medium-duty fastenings in cracked or uncracked concrete and corrosive environments, especially where shallow embedment and/or small edge distance or close spacing is required
■	Examples: stair hand rails, balcony safety railings, sprinkler pipes, air ducts, seating, facade substructures, car park barriers, etc.
■	Shallow embedment depth for thin concrete slabs or where permissible drilling depth is limited
■	Combines high working loads with small edge distances and close spacing thanks to very low expansion forces

Technical data	
<b>Head configuration</b>	Externally threaded
<b>Environmental conditions</b>	Outdoor
<b>Type of fastening</b>	Pre-fastening
<b>Material composition</b>	Steel, A4 (SS316)
<b>Installation direction</b>	All
<b>PROFIS</b>	Yes
<b>LEED information available</b>	Yes
<b>Additional product information</b>	Meets approval requirements when installed using the specified stop drill bit, setting tool and rotary hammer
<b>Material, corrosion</b>	Steel, stainless
<b>Required inserts</b>	TE-C-HSC-MW, TE-C-HSC-B



Anchor Systems

Ordering designation	Anchor size	Base plate clearance hole	Required tightening torque	Wrench size	Anchor length	Length identification mark	Max. fixture thickness at standard embedment depth	Sales pack quantity	Item number
HSC-AR M8x40/15	M8	9 mm	10 Nm	13 mm	72 mm	Two notches at end of anchor sleeve	15 mm	25 pc	31148
HSC-AR M8x50/15	M8	9 mm	10 Nm	13 mm	82 mm	No notch at end of anchor sleeve	15 mm	25 pc	31150
HSC-AR M10x40/20	M10	12 mm	20 Nm	17 mm	80 mm	Two notches at end of anchor sleeve	20 mm	25 pc	31149
HSC-AR M12x60/20	M12	14 mm	30 Nm	19 mm	104 mm	Three notches at end of anchor sleeve	20 mm	20 pc	15506

## Internally-threaded safety anchor (carbon steel) HSC-I



### Key applications and advantages

- Safety-relevant, medium-duty fastenings in cracked or uncracked concrete, especially where shallow embedment and/or small edge distance or close spacing is required
- Examples: stair hand rails, sprinkler pipes, air ducts, seating, facade substructures, car park barriers, etc.
- Shallow embedment depth for thin concrete slabs or where permissible drilling depth is limited
- Combines high working loads with small edge distances and close spacing thanks to very low expansion forces

### Technical data

<b>Head configuration</b>	Inner thread
<b>Environmental conditions</b>	Indoor, dry conditions
<b>Type of fastening</b>	Pre-fastening
<b>Material composition</b>	Bolt: steel, 8.8 grade, zinc-plated (min. 5 µm)
<b>Installation direction</b>	All
<b>PROFIS</b>	Yes
<b>LEED information available</b>	Yes
<b>Additional product information</b>	Meets approval requirements when installed using the specified stop drill bit, setting tool and rotary hammer
<b>Material, corrosion</b>	Steel, zinc-plated
<b>Required inserts</b>	TE-C-HSC-MW, TE-C-HSC-B



Ordering designation	Anchor size	Internal thread size	Thread engagement depth - max.	Thread engagement depth - min.	Base plate clearance hole	Required tightening torque	Wrench size	Sales pack quantity	Item number
HSC-I M8x40	M8	8 mm	22 mm	8 mm	9 mm	10 Nm	13 mm	25 pc	31143
HSC-I M10x50	M10	10 mm	28 mm	10 mm	12 mm	20 Nm	17 mm	25 pc	31144
HSC-I M10x60	M10	10 mm	28 mm	10 mm	12 mm	20 Nm	17 mm	25 pc	31145
HSC-I M12x60	M12	12 mm	30 mm	12 mm	14 mm	30 Nm	19 mm	25 pc	31146

## Internally-threaded safety anchor (stainless steel) HSC-IR



### Key applications and advantages

- Safety-relevant, medium-duty fastenings in cracked or uncracked concrete and corrosive environments, especially where shallow embedment and/or small edge distance or close spacing is required
- Examples: stair hand rails, balcony safety railings, sprinkler pipes, air ducts, seating, facade substructures, car park barriers, etc.
- Shallow embedment depth for thin concrete slabs or where permissible drilling depth is limited
- Combines high working loads with small edge distances and close spacing thanks to very low expansion forces

### Technical data

<b>Head configuration</b>	Inner thread
<b>Environmental conditions</b>	Outdoor
<b>Type of fastening</b>	Pre-fastening
<b>Material composition</b>	Steel, A4 (SS316)
<b>Installation direction</b>	All
<b>PROFIS</b>	Yes
<b>LEED information available</b>	Yes
<b>Additional product information</b>	Meets approval requirements when installed using the specified stop drill bit, setting tool and rotary hammer
<b>Material, corrosion</b>	Steel, stainless
<b>Required inserts</b>	TE-C-HSC-MW, TE-C-HSC-B



Ordering designation	Anchor size	Internal thread size	Thread engagement depth - max.	Thread engagement depth - min.	Base plate clearance hole	Required tightening torque	Wrench size	Sales pack quantity	Item number
HSC-IR M6x40	M6	6 mm	16 mm	6 mm	7 mm	10 Nm	10 mm	25 pc	31151
HSC-IR M8x40	M8	8 mm	22 mm	8 mm	9 mm	10 Nm	13 mm	25 pc	31152
HSC-IR M10x50	M10	10 mm	28 mm	10 mm	12 mm	20 Nm	17 mm	25 pc	31153
HSC-IR M12x60	M12	12 mm	30 mm	12 mm	14 mm	30 Nm	19 mm	25 pc	31155

**Stop drill bit TE-C-HSC-B**



**Key applications and advantages**

- Special drill bit required for drilling HSC anchor holes with defined drilling depth

**Technical data**

<b>Dispenser, setting tool, accessory, tester type</b>	Stop drill bits
--	-----------------



SDS plus

Ordering designation	Sales pack quantity	Item number
TE-C-HSC-B 16x40	1 pc	28568
TE-C-HSC-B 18x50	1 pc	30708
TE-C-HSC-B 18x60	1 pc	30709
TE-C-HSC-B 20x60	1 pc	30710
TE-C-HSC-B 14x40	1 pc	31157
TE-C-HSC-B 14x50	1 pc	31158

**Setting tool TE-C-HSC-MW**



**Key applications and advantages**

- Setting tool required for the HSC safety anchor automatic self-undercutting operation

**Technical data**

<b>Dispenser, setting tool, accessory, tester type</b>	Setting tools
--	---------------



SDS plus

Ordering designation	Connection end	Sales pack quantity	Item number
TE-C-HSC-MW16	TE-C	1 pc	11267
TE-C-HSC-MW14	TE-C	1 pc	31169
TE-C HSC-MW18	TE-C	1 pc	71352
TE-C-HSC-MW20	TE-C	1 pc	71353



### Key applications and advantages

- Medium- to heavy-duty fastenings in cracked or uncracked concrete
- Metro applications including overhead catenary systems, fire protection pipes and 3rd rail
- Reliable mechanical interlock thanks to consistent, high-quality undercut
- Comes as standard with a hot-dip galvanized coating for protection against corrosion



### Technical data

<b>Head configuration</b>	Externally threaded
<b>PROFIS</b>	Yes
<b>Additional product information</b>	Meets approval requirements when installed using the specified stop drill bit, setting tool and rotary hammer
<b>Material, corrosion</b>	Steel, sherardised / hot-dip galvanised
<b>Required inserts</b>	TE-C-HMU-B, TE-Y-HMU-UC, HMU-ST

## Undercut anchor system (hot-dip galvanized) HMU-PF



Ordering designation	Sales pack quantity	Item number
HMU-PF M16x100/20	12 pc	2036373
HMU-PF M16x100/20/50	12 pc	2036374
HMU-PF M16x125/20/50	12 pc	2036375

## Stop drill bit TE-C-HMU-B



### Key applications and advantages

- Stop drill bit ensures consistent drilled hole depth for proper installation of HMU undercut anchors

### Technical data

<b>Dispenser, setting tool, accessory, tester type</b>	Anchor testers and accessories, Stop drill bits
--	---



Ordering designation	Sales pack quantity	Item number
TE-C-HMU-B 22x100-M16	1 pc	2069054
TE-C-HMU-B 22x125-M16	1 pc	2069055
TE-C-HMU-B M12x80	1 pc	2084137

## Setting tool HMU-ST



### Key applications and advantages

- Ensures fast and reliable setting of the HMU undercut anchor

### Technical data

<b>Dispenser, setting tool, accessory, tester type</b>	Anchor testers and accessories, Setting tools
--	---



Ordering designation	Connection end	Sales pack quantity	Item number
HMU-ST M16	TE-C	1 pc	2036378

## Undercutting tool TE-Y-HMU-UC



### Key applications and advantages

- Produces consistent, high-quality undercuts

### Technical data

<b>Dispenser, setting tool, accessory, tester type</b>	Anchor testers and accessories, Undercut tools
--	--



SDS plus

Ordering designation	Sales pack quantity	Item number
TE-C-HMU-UC 22-M16	1 pc	2036249
HMU-UC-CB 22-M16	1 pc	2036370
HMU-UC-CB 22-M16 DIA	1 pc	2036371

## Dynamic / filling set HDA/HVZ

Ordering designation	Outer ring bolt diameter	Package contents	Sales pack quantity	Item number
Dynamic/filling set M10	42 mm	0.5x Hexagon nut M10	2 pc	369201
Dynamic/filling set M12	44 mm	0.5x Hexagon nut M12	2 pc	369202
Dynamic/filling set M16	52 mm	0.5x Hexagon nut M16	2 pc	369203
Dynamic/filling set M20	60 mm	0.5x Hexagon nut M20	2 pc	369204





### Setting tools for HSC anchors



HSC-A M8 40/15 31139  
HSC-AR M8 40/15 31148



HSC-I M6 40 31142  
HSC-IR M6 40 31151

EW 14 (\*)



TE-C-HSC-MW 14 31169



TE-C-HSC-B 14/40 31157



HSC-A M8 50/15 31141  
HSC-AR M8 50/15 31150



TE-C-HSC-MW 14 31169



TE-C-HSC-B 14/50 31158



HSC-A M10 40/20 31140  
HSC-AR M10 40/20 31149

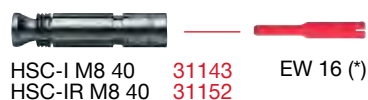

HSC-I M8 40 31143  
HSC-IR M8 40 31152

EW 16 (\*)



TE-C-HSC-MW 16 11267



TE-C-HSC-B 16/40 28568



HSC-A M12 60/20 15507  
HSC-AR M12 60/20 15506



HSC-I M10/60 31145  
HSC-IR M10/60 31154

EW 18 (\*)



TE-C-HSC-MW 18 71352



TE-C-HSC-B 18/60 30709



HSC-I M10/50 31144  
HSC-IR M10/50 31153

EW 18 (\*)



TE-C-HSC-MW 18 71352



TE-C-HSC-B 18/50 30708



HSC-I M12/60 31146  
HSC-IR M12/60 31155

EW 20 (\*)



TE-C-HSC-MW 20 71353



TE-C-HSC-B 20/60 30710



TE 30



TE 30

(\*) Included with HSC-I anchors

## Heavy-duty expansion anchor HSL-3



### Key applications and advantages

- Heavy-duty fastenings in high safety-relevant or dynamic applications, including applications in nuclear power plants
- Applications where extensive approval back-up or technical back-up is required, e.g. machines, heavy pipe equipment, steel columns, heavy pipe supports, pumps, beam supports, medical equipment, cantilevers, cranes, car hoists, etc.
- Heavy-duty applications, e.g. machines, heavy equipment, steel columns, heavy pipe supports, pumps, beam supports, medical equipment, cantilevers, cranes, car hoists, etc.
- High tension and shear load capacities
- Force-controlled expansion which allows follow-up expansion

Technical data	
<b>Head configuration</b>	Hex head
<b>Environmental conditions</b>	Indoor, dry conditions
<b>Type of fastening</b>	Through-fastening
<b>Material composition</b>	Steel, zinc-plated (min. 5 µm), Bolt: steel, 8.8 grade, zinc-plated (min. 5 µm)
<b>Tested/approved for diamond drilling</b>	Yes, with DD-EC 1
<b>IBC compliance</b>	IBC 2003, IBC 2006, IBC 2009, IBC 2012



Ordering designation	Anchor size	Anchor length	Base plate clearance hole	Required tightening torque	Wrench size	Max. fixture thickness at standard embedment depth	Drilling depth	Package contents	Sales pack quantity	Item number
HSL-3 M8/5	M8	83 mm	14 mm	25 Nm	13 mm	5 mm	80 mm	1x Heavy-duty anchor HSL-3 M 8/5 assy	40 pc	371774
HSL-3 M8/20	M8	98 mm	14 mm	25 Nm	13 mm	20 mm	80 mm	1x Heavy-duty anchor HSL-3 M 8/20 assy	40 pc	371775
HSL-3 M8/40	M8	118 mm	14 mm	25 Nm	13 mm	40 mm	80 mm	1x Heavy-duty anchor HSL-3 M 8/40 assy	40 pc	371776
HSL-3 M10/5	M10	95 mm	17 mm	50 Nm	17 mm	5 mm	90 mm	1x Heavy-duty anchor HSL-3 M 10/5 assy	20 pc	371777
HSL-3 M10/20	M10	110 mm	17 mm	50 Nm	17 mm	20 mm	90 mm	1x Heavy-duty anchor HSL-3 M 10/20 assy	20 pc	371778
HSL-3 M10/40	M10	130 mm	17 mm	50 Nm	17 mm	40 mm	90 mm	1x Heavy-duty anchor HSL-3 M 10/40 assy	20 pc	371779
HSL-3 M12/5	M12	111 mm	20 mm	80 Nm	19 mm	5 mm	105 mm	1x Heavy-duty anchor HSL-3 M 12/5 assy	20 pc	371780
HSL-3 M12/25	M12	131 mm	20 mm	80 Nm	19 mm	25 mm	105 mm	1x Heavy-duty anchor HSL-3 M 12/25 assy	20 pc	371781
HSL-3 M12/50	M12	156 mm	20 mm	80 Nm	19 mm	50 mm	105 mm	1x Heavy-duty anchor HSL-3 M 12/50 assy	10 pc	371782
HSL-3 M16/10	M16	138 mm	26 mm	120 Nm	24 mm	10 mm	125 mm	1x Heavy-duty anchor HSL-3 M 16/10 assy	10 pc	371783
HSL-3 M16/25	M16	153 mm	26 mm	120 Nm	24 mm	25 mm	125 mm	1x Heavy-duty anchor HSL-3 M 16/25 assy	10 pc	371784
HSL-3 M16/50	M16	178 mm	26 mm	120 Nm	24 mm	50 mm	125 mm	1x Heavy-duty anchor HSL-3 M 16/50 assy	10 pc	371785
HSL-3 M20/10	M20	163 mm	31 mm	200 Nm	30 mm	10 mm	155 mm	1x Heavy-duty anchor HSL-3 M 20/10 assy	6 pc	371786
HSL-3 M20/30	M20	183 mm	31 mm	200 Nm	30 mm	30 mm	155 mm	1x Heavy-duty anchor HSL-3 M 20/30 assy	6 pc	371787
HSL-3 M20/60	M20	213 mm	31 mm	200 Nm	30 mm	60 mm	155 mm	1x Heavy-duty anchor HSL-3 M 20/60 assy	6 pc	371788
HSL-3 M24/10	M24	185 mm	35 mm	250 Nm	36 mm	10 mm	180 mm	1x Heavy-duty anchor HSL-3 M 24/10 assy	4 pc	371789
HSL-3 M24/30	M24	205 mm	35 mm	250 Nm	36 mm	30 mm	180 mm	1x Heavy-duty anchor HSL-3 M 24/30 assy	4 pc	371790
HSL-3 M24/60	M24	235 mm	35 mm	250 Nm	36 mm	60 mm	180 mm	1x Heavy-duty anchor HSL-3 M 24/60 assy	4 pc	371791

## Heavy-duty expansion stud anchor HSL-3-G



### Key applications and advantages

- Heavy-duty fastenings in highly safety-relevant or dynamic applications, including applications in nuclear power plants
- Applications where extensive approval back-up or technical back-up is required, e.g. machines, heavy equipment, steel columns, heavy pipe supports, pumps, beam supports, medical equipment, cantilevers, cranes, car hoists, etc.
- High tensile and shear load capacity
- Force-controlled expansion allows follow-up expansion

### Technical data

<b>Head configuration</b>	Externally threaded
<b>Environmental conditions</b>	Indoor, dry conditions
<b>Type of fastening</b>	Through-fastening
<b>Material composition</b>	Steel, zinc-plated (min. 5 µm), Bolt: steel, 8.8 grade, zinc-plated (min. 5 µm)
<b>Tested/approved for diamond drilling</b>	Yes, with DD-EC 1
<b>IBC compliance</b>	IBC 2003, IBC 2006, IBC 2009, IBC 2012
<b>PROFIS</b>	Yes
<b>LEED information available</b>	Yes
<b>Additional product information</b>	Manufactured under a nuclear quality assurance program according to ASME NQA-1 and 10CFR50 App. B
<b>Material, corrosion</b>	Steel, zinc-plated



Ordering designation	Anchor size	Anchor length	Base plate clearance hole	Required tightening torque	Wrench size	Max. fixture thickness at standard embedment depth	Drilling depth	Package contents	Sales pack quantity	Item number
HSL-3-G M8/20	M8	102 mm	14 mm	20 Nm	13 mm	20 mm	80 mm	1x Heavy-duty anchor HSL-3-G M 8/20 assy	40 pc	371793
HSL-3-G M8/40	M8	122 mm	14 mm	20 Nm	13 mm	40 mm	80 mm	1x Heavy-duty anchor HSL-3-G M 8/40 assy	40 pc	371794
HSL-3-G M8/100	M8	182 mm	14 mm	20 Nm	13 mm	100 mm	80 mm	1x Heavy-duty anchor HSL-3-G M 8/100 assy	20 pc	371829
HSL-3-G M10/5	M10	100 mm	17 mm	35 Nm	17 mm	5 mm	90 mm	1x Heavy-duty anchor HSL-3-G M 10/5 assy	20 pc	371795
HSL-3-G M10/20	M10	115 mm	17 mm	35 Nm	17 mm	20 mm	90 mm	1x Heavy-duty anchor HSL-3-G M 10/20 assy	20 pc	371796
HSL-3-G M10/40	M10	135 mm	17 mm	35 Nm	17 mm	40 mm	90 mm	1x Heavy-duty anchor HSL-3-G M 10/40 assy	20 pc	371797
HSL-3-G M10/100	M10	195 mm	17 mm	35 Nm	17 mm	100 mm	90 mm	1x Heavy-duty anchor HSL-3-G M 10/100 assy	20 pc	371830
HSL-3-G M12/5	M12	119 mm	20 mm	60 Nm	19 mm	5 mm	105 mm	1x Heavy-duty anchor HSL-3-G M 12/5 assy	20 pc	371798
HSL-3-G M12/25	M12	139 mm	20 mm	60 Nm	19 mm	25 mm	105 mm	1x Heavy-duty anchor HSL-3-G M 12/25 assy	20 pc	371799
HSL-3-G M12/50	M12	164 mm	20 mm	60 Nm	19 mm	50 mm	105 mm	1x Heavy-duty anchor HSL-3-G M 12/50 assy	10 pc	371800
HSL-3-G M12/100	M12	214 mm	20 mm	60 Nm	19 mm	100 mm	105 mm	1x Heavy-duty anchor HSL-3-G M 12/100 assy	10 pc	371831
HSL-3-G M16/10	M16	148 mm	26 mm	80 Nm	24 mm	10 mm	125 mm	1x Heavy-duty anchor HSL-3-G M 16/10 assy	10 pc	371801
HSL-3-G M16/25	M16	163 mm	26 mm	80 Nm	24 mm	25 mm	125 mm	1x Heavy-duty anchor HSL-3-G M 16/25 assy	10 pc	371802
HSL-3-G M16/50	M16	188 mm	26 mm	80 Nm	24 mm	50 mm	125 mm	1x Heavy-duty anchor HSL-3-G M 16/50 assy	10 pc	371803
HSL-3-G M16/100	M16	238 mm	26 mm	80 Nm	24 mm	100 mm	125 mm	1x Heavy-duty anchor HSL-3-G M 16/100 assy	10 pc	371832
HSL-3-G M20/10	M20	170 mm	31 mm	160 Nm	30 mm	10 mm	155 mm	1x Heavy-duty anchor HSL-3-G M 20/10 assy	6 pc	371804
HSL-3-G M20/30	M20	190 mm	31 mm	160 Nm	30 mm	30 mm	155 mm	1x Heavy-duty anchor HSL-3-G M 20/30 assy	6 pc	371805
HSL-3-G M20/60	M20	220 mm	31 mm	160 Nm	30 mm	60 mm	155 mm	1x Heavy-duty anchor HSL-3-G M 20/60 assy	6 pc	371806
HSL-3-G M20/100	M20	260 mm	31 mm	160 Nm	30 mm	100 mm	155 mm	1x Heavy-duty anchor HSL-3-G M 20/100 assy	6 pc	371833

## Heavy-duty stainless steel expansion anchor HSL-GR



### Key applications and advantages

- Heavy-duty fastenings in safety-relevant applications and corrosive environments, e.g. pumps, heavy equipment, antennas, heavy pipe supports, medical equipment, etc.
- High tensile and shear load capacity
- Force-controlled expansion

### Technical data

<b>Head configuration</b>	Externally threaded
<b>Environmental conditions</b>	Outdoor
<b>Type of fastening</b>	Through-fastening
<b>Material composition</b>	Steel, A4 (SS316)
<b>PROFIS</b>	Yes
<b>Material, corrosion</b>	Steel, stainless

**PROFIS**  
software

Ordering designation	Anchor size	Anchor length	Base plate clearance hole	Required tightening torque	Wrench size	Max. fixture thickness at standard embedment depth	Drilling depth	Package contents	Sales pack quantity	Item number
HSLGR M8/20	M8	102 mm	14 mm	25 Nm	13 mm	20 mm	80 mm	1x Heavy-duty anchor HSL-G-R M8/20 assy	40 pc	67920
HSLGR M10/20	M10	115 mm	17 mm	50 Nm	17 mm	20 mm	90 mm	1x Heavy-duty anchor HSL-G-R M10/20 assy	20 pc	67922
HSLGR M12/25	M12	139 mm	20 mm	80 Nm	19 mm	25 mm	100 mm	1x Heavy-duty anchor HSL-G-R M12/25 assy	20 pc	67924
HSLGR M16/25	M16	163 mm	26 mm	120 Nm	24 mm	25 mm	125 mm	1x Heavy-duty anchor HSL-G-R M16/25 assy	10 pc	67926
HSLGR M20/30	M20	190 mm	31 mm	200 Nm	30 mm	30 mm	155 mm	1x Heavy-duty anchor HSL-G-R M20/30 assy	6 pc	67928

## Heavy-duty expansion anchor HSL-3-SK



### Key applications and advantages

- Fastenings in safety-relevant and/or dynamic applications where a flush installation or aesthetic appearance is required, including applications in nuclear power plants
- Applications where extensive approval back-up or technical back-up is required
- Various uses such as for medical equipment, hand rails, machines, car hoists, safety fences, pumps, etc.
- Aesthetic appearance and no tripping hazard due to flush installation
- High tensile and shear load capacity, force-controlled expansion allows follow-up expansion

### Technical data

<b>Head configuration</b>	Countersunk
<b>Environmental conditions</b>	Indoor, dry conditions
<b>Type of fastening</b>	Through-fastening
<b>Material composition</b>	Steel, zinc-plated (min. 5 µm), Bolt: steel, 8.8 grade, zinc-plated (min. 5 µm)
<b>Tested/approved for diamond drilling</b>	No
<b>IBC compliance</b>	IBC 2003, IBC 2006, IBC 2009, IBC 2012
<b>PROFIS</b>	Yes
<b>LEED information available</b>	Yes
<b>Additional product information</b>	Manufactured under a nuclear quality assurance program according to ASME NQA-1-2000 and 10CFR50 App. B
<b>Material, corrosion</b>	Steel, zinc-plated



Ordering designation	Anchor size	Anchor length	Base plate clearance hole	Required tightening torque	Socket size	Max. fixture thickness at standard embedment depth	Drilling depth	Package contents	Sales pack quantity	Item number
HSL-3-SK M8/10	M8	80 mm	14 mm	25 Nm	5 mm	10 mm	80 mm	1x Heavy-duty anchor HSL-3-SK M8/10 assy	40 pc	371825
HSL-3-SK M8/20	M8	90 mm	14 mm	25 Nm	5 mm	20 mm	80 mm	1x Heavy-duty anchor HSL-3-SK M8/20 assy	40 pc	371826
HSL-3-SK M10/20	M10	102 mm	17 mm	50 Nm	6 mm	20 mm	90 mm	1x Heavy-duty anchor HSL-3-SK M10/20 assy	20 pc	371827
HSL-3-SK M12/25	M12	120 mm	20 mm	80 Nm	8 mm	25 mm	105 mm	1x Heavy-duty anchor HSL-3-SK M12/25 assy	20 pc	371828



### Key applications and advantages

- Particularly suitable for safety relevant applications
- Facades
- Structural steel
- High-performance stud anchor. The optimised design of the expansion pieces and tapered section combined with special steel and coatings ensure outstanding performance in cracked and uncracked concrete
- Suitable for applications in cracked concrete

### Technical data

<b>Head configuration</b>	Externally threaded
<b>Environmental conditions</b>	Indoor, dry conditions
<b>Type of fastening</b>	Pre-fastening, Through-fastening
<b>Material composition</b>	Steel, zinc-plated (min. 5 µm)
<b>Installation direction</b>	All
<b>Tested/approved for diamond drilling PROFIS</b>	No
<b>LEED information available</b>	Yes
<b>Material, corrosion</b>	Steel, zinc-plated
<b>Accessories</b>	HSV/ HSA/ HST/ KB3/ KB-TZ, Hilti HIT



## Stud anchor HST



Ordering designation	Anchor size	Anchor length	Base plate clearance hole	Required tightening torque	Wrench/nut size	Socket size	Wrench size	Sales pack quantity	Item number
HST M8x75/10	M8	75 mm	9 mm	20 Nm	13 mm	13 mm	13 mm	100 pc	371581
HST M8x95/30	M8	95 mm	9 mm	20 Nm	13 mm	13 mm	13 mm	80 pc	295378
HST M8x115/50	M8	115 mm	9 mm	20 Nm	13 mm	13 mm	13 mm	50 pc	371583
HST M10x90/10	M10	90 mm	12 mm	45 Nm	17 mm	17 mm	17 mm	50 pc	371584
HST M10x110/30	M10	110 mm	12 mm	45 Nm	17 mm	17 mm	17 mm	40 pc	295367
HST M10x130/50	M10	130 mm	12 mm	45 Nm	17 mm	17 mm	17 mm	25 pc	371586
HST M12x115/20	M12	115 mm	14 mm	60 Nm	19 mm	19 mm	19 mm	25 pc	371587
HST M12x145/50	M12	145 mm	14 mm	60 Nm	19 mm	19 mm	19 mm	25 pc	371588
HST M12x185/90	M12	185 mm	14 mm	60 Nm	19 mm	19 mm	19 mm	25 pc	371589
HST M12x215/120	M12	215 mm	14 mm	60 Nm	19 mm	19 mm	19 mm	25 pc	371590
HST M12x255/160	M12	255 mm	14 mm	60 Nm	19 mm	19 mm	19 mm	25 pc	371592
HST M16x140/25	M16	140 mm	18 mm	110 Nm	24 mm	24 mm	24 mm	12 pc	371593
HST M16x165/50	M16	165 mm	18 mm	110 Nm	24 mm	24 mm	24 mm	12 pc	371594
HST M16x215/100	M16	215 mm	18 mm	110 Nm	24 mm	24 mm	24 mm	12 pc	371595
HST M16x255/140	M16	255 mm	18 mm	110 Nm	24 mm	24 mm	24 mm	12 pc	371596
HST M16x295/180	M16	295 mm	18 mm	110 Nm	24 mm	24 mm	24 mm	12 pc	371597
HST M20x170/30	M20	170 mm	22 mm	240 Nm	30 mm	30 mm	30 mm	5 pc	371598
HST M20x200/60	M20	200 mm	22 mm	240 Nm	30 mm	30 mm	30 mm	5 pc	371599
HST M20x260/120	M20	260 mm	22 mm	240 Nm	30 mm	30 mm	30 mm	5 pc	274697
HST M24x200/30	M24	200 mm	26 mm	300 Nm	36 mm	36 mm	36 mm	5 pc	371601
HST M24x230/60	M24	230 mm	26 mm	300 Nm	36 mm	36 mm	36 mm	5 pc	371602

### Stud anchor HST-R



#### Key applications and advantages

- Particularly suited to safety-relevant applications in corrosive environments
- Facades
- Structural steel
- High-performance stud anchor with optimised expansion cone and wedge design combined with special steel quality and coatings for outstanding performance
- Suitable for applications in cracked concrete

#### Technical data

<b>Head configuration</b>	Externally threaded
<b>Environmental conditions</b>	Outdoor
<b>Type of fastening</b>	Pre-fastening, Through-fastening
<b>Material composition</b>	Steel, A4 (SS316)
<b>Installation direction</b>	All
<b>Tested/approved for diamond drilling</b>	No
<b>PROFIS</b>	Yes
<b>LEED information available</b>	Yes
<b>Material, corrosion</b>	Steel, stainless
<b>Accessories</b>	HSV/ HSA/ HST/ KB3/ KB-TZ, Hilti HIT



Ordering designation	Anchor size	Anchor length	Base plate clearance hole	Required tightening torque	Wrench/nut size	Socket size	Wrench size	Sales pack quantity	Item number
HST-R M8x75/10	M8	75 mm	9 mm	20 Nm	13 mm	13 mm	13 mm	50 pc	435447
HST-R M8x95/30	M8	95 mm	9 mm	20 Nm	13 mm	13 mm	13 mm	50 pc	435448
HST-R M8x115/50	M8	115 mm	9 mm	20 Nm	13 mm	13 mm	13 mm	50 pc	435449
HST-R M10x90/10	M10	90 mm	12 mm	45 Nm	17 mm	17 mm	17 mm	50 pc	435450
HST-R M10x110/30	M10	110 mm	12 mm	45 Nm	17 mm	17 mm	17 mm	40 pc	435451
HST-R M10x130/50	M10	130 mm	12 mm	45 Nm	17 mm	17 mm	17 mm	25 pc	435452
HST-R M10x160/80	M10	160 mm	12 mm	45 Nm	17 mm	17 mm	17 mm	25 pc	435453
HST-R M12x115/20	M12	115 mm	14 mm	60 Nm	19 mm	19 mm	19 mm	25 pc	435454
HST-R M12x145/50	M12	145 mm	14 mm	60 Nm	19 mm	19 mm	19 mm	25 pc	435455
HST-R M12x185/90	M12	185 mm	14 mm	60 Nm	19 mm	19 mm	19 mm	25 pc	435456
HST-R M12x215/120	M12	215 mm	14 mm	60 Nm	19 mm	19 mm	19 mm	25 pc	435457
HST-R M16x140/25	M16	140 mm	18 mm	110 Nm	24 mm	24 mm	24 mm	12 pc	376051
HST-R M16x165/50	M16	165 mm	18 mm	110 Nm	24 mm	24 mm	24 mm	12 pc	376052
HST-R M16x215/100	M16	215 mm	18 mm	110 Nm	24 mm	24 mm	24 mm	12 pc	376053
HST-R M16x255/140	M16	255 mm	18 mm	110 Nm	24 mm	24 mm	24 mm	12 pc	376054
HST-R M16x295/180	M16	295 mm	18 mm	110 Nm	24 mm	24 mm	24 mm	12 pc	376055
HST-R M20x170/30	M20	170 mm	22 mm	240 Nm	30 mm	30 mm	30 mm	5 pc	376056
HST-R M20x200/60	M20	200 mm	22 mm	240 Nm	30 mm	30 mm	30 mm	5 pc	376057
HST-R M24x200/30	M24	200 mm	26 mm	300 Nm	36 mm	36 mm	36 mm	5 pc	376058
HST-R M24x230/60	M24	230 mm	26 mm	300 Nm	36 mm	36 mm	36 mm	5 pc	376059

### Stud anchor HST-HCR



#### Key applications and advantages

- Particularly suited to safety-relevant applications in highly corrosive environments
- Swimming pools
- Water treatment plants
- High performance stud anchor. The optimised design of the expansion pieces and tapered section combined with special steel and coatings ensure outstanding performance in cracked and uncracked concrete
- Suitable for applications in cracked concrete

#### Technical data

<b>Head configuration</b>	Externally threaded
<b>Environmental conditions</b>	Highly corrosive special applications
<b>Type of fastening</b>	Pre-fastening, Through-fastening
<b>Material composition</b>	Steel, high corrosion resistant (HCR)
<b>Installation direction</b>	All
<b>Tested/approved for diamond drilling</b>	No
<b>PROFIS</b>	Yes
<b>LEED information available</b>	Yes
<b>Material, corrosion</b>	Steel, high corrosion resistant (HCR)
<b>Accessories</b>	HSV/ HSA/ HST/ KB3/ KB-TZ, Hilti HIT



Ordering designation	Anchor size	Anchor length	Base plate clearance hole	Required tightening torque	Wrench/nut size	Socket size	Wrench size	Sales pack quantity	Item number
HST-HCR M10x90/10	M10	90 mm	12 mm	45 Nm	17 mm	17 mm	17 mm	50 pc	387259

Ordering designation	Anchor size	Anchor length	Base plate clearance hole	Required tightening torque	Wrench/nut size	Socket size	Wrench size	Sales pack quantity	Item number
HST-HCR M10x110/30	M10	110 mm	12 mm	45 Nm	17 mm	17 mm	17 mm	40 pc	295369
HST-HCR M12x115/20	M12	115 mm	14 mm	60 Nm	19 mm	19 mm	19 mm	10 pc	376066
HST-HCR M12x145/50	M12	145 mm	14 mm	60 Nm	19 mm	19 mm	19 mm	10 pc	376067
HST-HCR M12x185/90	M12	185 mm	14 mm	60 Nm	19 mm	19 mm	19 mm	10 pc	376068
HST-HCR M12x215/120	M12	215 mm	14 mm	60 Nm	19 mm	19 mm	19 mm	10 pc	376069
HST-HCR M16x140/25	M16	140 mm	18 mm	110 Nm	24 mm	24 mm	24 mm	10 pc	376070
HST-HCR M16x165/50	M16	165 mm	18 mm	110 Nm	24 mm	24 mm	24 mm	10 pc	376071
HST-HCR M16x215/100	M16	215 mm	18 mm	110 Nm	24 mm	24 mm	24 mm	10 pc	376072
HST-HCR M16x255/140	M16	255 mm	18 mm	110 Nm	24 mm	24 mm	24 mm	10 pc	376073
HST-HCR M16x295/180	M16	295 mm	18 mm	110 Nm	24 mm	24 mm	24 mm	10 pc	376074



**Key applications and advantages**

- Fastening facade brackets
- Fastening columns and beams
- Fastening brackets and channels
- High loads due to concrete cone failure
- 3 embedment depths for maximum flexibility



Technical data	
<b>Head configuration</b>	Externally threaded
<b>Environmental conditions</b>	Indoor, dry conditions
<b>Type of fastening</b>	Pre-fastening, Through-fastening
<b>Material composition</b>	Steel, zinc-plated (min. 5 µm)
<b>Installation direction</b>	All
<b>Tested/approved for diamond drilling</b>	Yes
<b>PROFIS</b>	Yes
<b>LEED information available</b>	Yes
<b>Material, corrosion</b>	Steel, zinc-plated
<b>Accessories</b>	HSV/ HSA/ HST/ KB3/ KB-TZ, Hilti HIT



**Standard stud anchor HSA**



Ordering designation	Anchor size	Anchor length	Base plate clearance hole	Required tightening torque	Socket size	Wrench size	Thread length	Sales pack quantity	Item number
HSA M6x50 5/-/-	M6	50 mm	7 mm	5 Nm	10 mm	10 mm	15 mm	200 pc	2036084
HSA M6x65 20/10/-	M6	65 mm	7 mm	5 Nm	10 mm	10 mm	30 mm	200 pc	2036085
HSA M6 x 85 40/30/10	M6	85 mm	7 mm	5 Nm	10 mm	10 mm	50 mm	100 pc	2036086
HSA M6x100 55/45/25	M6	100 mm	7 mm	5 Nm	10 mm	10 mm	65 mm	100 pc	2036087
HSA M8x55 5/-/-	M8	55 mm	9 mm	15 Nm	13 mm	13 mm	17 mm	100 pc	2004122
HSA M8x70 20/10/-	M8	70 mm	9 mm	15 Nm	13 mm	13 mm	32 mm	100 pc	2004123
HSA M8x85 35/25/-	M8	85 mm	9 mm	15 Nm	13 mm	13 mm	47 mm	80 pc	2004124
HSA M8x105 55/45/15	M8	105 mm	9 mm	15 Nm	13 mm	13 mm	67 mm	50 pc	2004125
HSA M8x130 80/70/40	M8	130 mm	9 mm	15 Nm	13 mm	13 mm	92 mm	50 pc	2004126
HSA M10x68 5/-/-	M10	68 mm	12 mm	25 Nm	17 mm	17 mm	19 mm	50 pc	2004127
HSA M10x83 20/10/-	M10	83 mm	12 mm	25 Nm	17 mm	17 mm	34 mm	50 pc	2004128
HSA M10x98 35/25/-	M10	98 mm	12 mm	25 Nm	17 mm	17 mm	49 mm	40 pc	2004129
HSA M10x113 50/40/10	M10	113 mm	12 mm	25 Nm	17 mm	17 mm	64 mm	40 pc	2004150
HSA M10x133 70/60/30	M10	133 mm	12 mm	25 Nm	17 mm	17 mm	81 mm	25 pc	2004151
HSA M10x153 90/80/50	M10	153 mm	12 mm	25 Nm	17 mm	17 mm	101 mm	25 pc	2004152
HSA M10x168 105/95/65	M10	168 mm	12 mm	25 Nm	17 mm	17 mm	116 mm	25 pc	2004153
HSA M12x85 5/-/-	M12	85 mm	14 mm	50 Nm	19 mm	19 mm	22 mm	25 pc	2004154
HSA M12x100 20/5/-	M12	100 mm	14 mm	50 Nm	19 mm	19 mm	37 mm	25 pc	2004155
HSA M12x115 35/20/-	M12	115 mm	14 mm	50 Nm	19 mm	19 mm	52 mm	25 pc	2004156
HSA M12x145 65/50/15	M12	145 mm	14 mm	50 Nm	19 mm	19 mm	82 mm	25 pc	2004157
HSA M12x175 95/80/45	M12	175 mm	14 mm	50 Nm	19 mm	19 mm	112 mm	25 pc	2004158
HSA M12x205 125/110/75	M12	205 mm	14 mm	50 Nm	19 mm	19 mm	142 mm	25 pc	2004159
HSA M12x225 145/130/95	M12	225 mm	14 mm	50 Nm	19 mm	19 mm	162 mm	25 pc	2004160
HSA M16x102 5/-/-	M16	102 mm	18 mm	80 Nm	24 mm	24 mm	26 mm	16 pc	2004161
HSA M16x117 20/5/-	M16	117 mm	18 mm	80 Nm	24 mm	24 mm	41 mm	16 pc	2004162
HSA M16x137 40/25/-	M16	137 mm	18 mm	80 Nm	24 mm	24 mm	61 mm	16 pc	2004163
HSA M16x182 85/70/30	M16	182 mm	18 mm	80 Nm	24 mm	24 mm	106 mm	16 pc	2004164
HSA M16x232 135/120/80	M16	232 mm	18 mm	80 Nm	24 mm	24 mm	156 mm	16 pc	2004165
HSA M20x125 10/-/-	M20	125 mm	22 mm	200 Nm	30 mm	30 mm	36 mm	10 pc	2036088
HSA M20x170 55/30/15	M20	170 mm	22 mm	200 Nm	30 mm	30 mm	81 mm	10 pc	2036089



## Stud anchor with large washer HSA-BW



### Key applications and advantages

- Wide range of fastening applications in concrete
- Especially when fastening through slotted or oversized holes
- Fastening brackets and channels
- High loads (optimal utilization of the concrete strength)
- Excellent edge and spacing distances

### Technical data

<b>Head configuration</b>	Externally threaded
<b>Environmental conditions</b>	Indoor, dry conditions
<b>Type of fastening</b>	Pre-fastening, Through-fastening
<b>Material composition</b>	Steel, zinc-plated (min. 5 µm)
<b>Installation direction</b>	All
<b>Tested/approved for diamond drilling</b>	Yes
<b>PROFIS</b>	Yes
<b>LEED information available</b>	Yes
<b>Material, corrosion</b>	Steel, zinc-plated
<b>Accessories</b>	HSV/ HSA/ HST/ KB3/ KB-TZ, Hiiti HIT



Ordering designation	Anchor size	Anchor length	Base plate clearance hole	Required tightening torque	Wrench/nut size	Socket size	Wrench size	Sales pack quantity	Item number
HSA M8x55 5/-/- BW	M8	55 mm	9 mm	15 Nm	13 mm	13 mm	13 mm	100 pc	2004223
HSA M8x70 20/10/- BW	M8	70 mm	9 mm	15 Nm	13 mm	13 mm	13 mm	100 pc	2004224
HSA M10x68 5/-/- BW	M10	68 mm	12 mm	30 Nm	17 mm	17 mm	17 mm	25 pc	2004225
HSA M10x83 20/10/- BW	M10	83 mm	12 mm	30 Nm	17 mm	17 mm	17 mm	25 pc	2004226
HSA M12x85 5/-/- BW	M12	85 mm	14 mm	50 Nm	19 mm	19 mm	19 mm	20 pc	2004227
HSA M12x100 20/5/- BW	M12	100 mm	14 mm	50 Nm	19 mm	19 mm	19 mm	16 pc	2004228
HSA M16x102 5/-/- BW	M16	102 mm	18 mm	100 Nm	24 mm	24 mm	24 mm	12 pc	2004229
HSA M16x117 20/5/- BW	M16	117 mm	18 mm	100 Nm	24 mm	24 mm	24 mm	12 pc	2004230
HSA M16x137 40/25/- BW	M16	137 mm	18 mm	100 Nm	24 mm	24 mm	24 mm	12 pc	2004231

## Standard hot-dip galvanized stud anchor HSA-F



### Key applications and advantages

- Fastening brackets and channels
- Fastening columns and beams
- Wide range of fastening applications in concrete
- Fast, convenient and reliable torquing using SIW 14-A or 22-A impact wrench with S-TB
- Suitable for presetting and through-fastening in uncracked concrete

### Technical data

<b>Head configuration</b>	Externally threaded
<b>Environmental conditions</b>	Indoor, damp conditions
<b>Type of fastening</b>	Pre-fastening, Through-fastening
<b>Material composition</b>	Steel, hot-dip galvanized (min. 35 µm)
<b>Installation direction</b>	All
<b>Tested/approved for diamond drilling</b>	Yes
<b>LEED information available</b>	Yes
<b>Material, corrosion</b>	Steel, sherardised / hot-dip galvanized
<b>Accessories</b>	HSV/ HSA/ HST/ KB3/ KB-TZ, Hiiti HIT



Ordering designation	Anchor size	Anchor length	Base plate clearance hole	Required tightening torque	Socket size	Thread length	Length identification mark	Sales pack quantity	Item number
HSA-F M6x50 5/-/-	M6	50 mm	7 mm	5 Nm	10 mm	15 mm	z	200 pc	2036310
HSA-F M6x65 20/10/-	M6	65 mm	7 mm	5 Nm	10 mm	30 mm	w	200 pc	2036311
HSA-F M8x55 5/-/-	M8	55 mm	9 mm	15 Nm	13 mm	17 mm	z	100 pc	2004113
HSA-F M8x70 20/10/-	M8	70 mm	9 mm	15 Nm	13 mm	32 mm	w	100 pc	2004114
HSA-F M8x85 35/25/-	M8	85 mm	9 mm	15 Nm	13 mm	47 mm	t	80 pc	2004115
HSA-F M8x105 55/45/15	M8	105 mm	9 mm	15 Nm	13 mm	67 mm	p	50 pc	2004116
HSA-F M8x130 80/70/40	M8	130 mm	9 mm	15 Nm	13 mm	92 mm	k	50 pc	2004117
HSA-F M10x68 5/-/-	M10	68 mm	12 mm	25 Nm	17 mm	19 mm	z	50 pc	2004118
HSA-F M10x83 20/10/-	M10	83 mm	12 mm	25 Nm	17 mm	34 mm	w	50 pc	2004119
HSA-F M10x98 35/25/-	M10	98 mm	12 mm	25 Nm	17 mm	49 mm	t	40 pc	2004170
HSA-F M10x113 50/40/10	M10	113 mm	12 mm	25 Nm	17 mm	64 mm	q	40 pc	2004171
HSA-F M12x85 5/-/-	M12	85 mm	14 mm	50 Nm	19 mm	22 mm	z	25 pc	2004172
HSA-F M12x100 20/5/-	M12	100 mm	14 mm	50 Nm	19 mm	37 mm	w	25 pc	2004173
HSA-F M12x115 35/20/-	M12	115 mm	14 mm	50 Nm	19 mm	52 mm	t	25 pc	2004174

Ordering designation	Anchor size	Anchor length	Base plate clearance hole	Required tightening torque	Socket size	Thread length	Length identification mark	Sales pack quantity	Item number
HSA-F M12x145 65/50/15	M12	145 mm	14 mm	50 Nm	19 mm	82 mm	n	25 pc	2004175
HSA-F M12x225 145/130/95	M12	225 mm	14 mm	50 Nm	19 mm	162 mm	a	25 pc	2004176
HSA-F M16x102 5/-/-	M16	102 mm	18 mm	80 Nm	24 mm	26 mm	z	16 pc	2004177
HSA-F M16x137 40/25/-	M16	137 mm	18 mm	80 Nm	24 mm	61 mm	s	16 pc	2004178
HSA-F M16x182 85/70/30	M16	182 mm	18 mm	80 Nm	24 mm	106 mm	J	16 pc	2004179
HSA-F M20x125 10/-/-	M20	125 mm	22 mm	200 Nm	24 mm	36 mm	y	10 pc	2036312
HSA-F M20x170 55/30/15	M20	170 mm	22 mm	200 Nm	24 mm	81 mm	p	10 pc	2036313

**Standard stud anchor HSA-R2**



**Key applications and advantages**

- Fastening facade brackets
- Fastening brackets and channels
- Fastening columns and beams
- High loads (optimal utilization of the concrete strength)
- 3 embedment depths offering maximum flexibility

**Technical data**

<b>Head configuration</b>	Externally threaded
<b>Type of fastening</b>	Pre-fastening, Through-fastening
<b>Material composition</b>	Steel, A2 (SS 304)
<b>Installation direction</b>	All
<b>Tested/approved for diamond drilling</b>	Yes
<b>PROFIS</b>	Yes
<b>LEED information available</b>	Yes
<b>Material, corrosion</b>	Steel, stainless
<b>Accessories</b>	HSV/ HSA/ HST/ KB3/ KB-TZ, Hilti HIT
<b>Installation tools</b>	SIW 14-A



Ordering designation	Anchor size	Anchor length	Base plate clearance hole	Required tightening torque	Socket size	Wrench size	Fastening thickness at embed.1	Sales pack quantity	Item number
HSA-R2 M8x70 20/10/-	M8	70 mm	9 mm	15 Nm	13 mm	13 mm	20 mm	100 pc	2004218
HSA-R2 M10x83 20/10/-	M10	83 mm	12 mm	25 Nm	17 mm	17 mm	20 mm	50 pc	2004219
HSA-R2 M12x100 20/5/-	M12	100 mm	14 mm	50 Nm	19 mm	19 mm	20 mm	25 pc	2004220
HSA-R2 M12x115 35/20/-	M12	115 mm	14 mm	50 Nm	19 mm	19 mm	35 mm	25 pc	2004221
HSA-R2 M16x137 40/25/-	M16	137 mm	18 mm	80 Nm	24 mm	24 mm	40 mm	16 pc	2004222

**Standard stud anchor HSA-R**



**Key applications and advantages**

- Fastening facade brackets
- Fastening columns and beams
- Fastening brackets and channels
- High loads (optimal utilization of the concrete strength)
- 3 embedment depths offering maximum flexibility

**Technical data**

<b>Head configuration</b>	Externally threaded
<b>Environmental conditions</b>	Outdoor
<b>Type of fastening</b>	Pre-fastening, Through-fastening
<b>Material composition</b>	Steel, A4 (SS316)
<b>Installation direction</b>	All
<b>Tested/approved for diamond drilling</b>	Yes
<b>PROFIS</b>	Yes
<b>LEED information available</b>	Yes
<b>Material, corrosion</b>	Steel, stainless
<b>Accessories</b>	HSV/ HSA/ HST/ KB3/ KB-TZ, Hilti HIT



Ordering designation	Anchor size	Anchor length	Base plate clearance hole	Required tightening torque	Socket size	Wrench size	Thread length	Sales pack quantity	Item number
HSA-R M6x50 5/-/-	M6	50 mm	7 mm	5 Nm	10 mm	10 mm	15 mm	200 pc	2036314
HSA-R M6x65 20/10/-	M6	65 mm	7 mm	5 Nm	10 mm	10 mm	30 mm	200 pc	2036315
HSA-R M6x85 40/30/10	M6	85 mm	7 mm	5 Nm	10 mm	10 mm	50 mm	100 pc	2036316
HSA-R M8x55 5/-/-	M8	55 mm	9 mm	15 Nm	13 mm	13 mm	17 mm	100 pc	2004197
HSA-R M8x70 20/10/-	M8	70 mm	9 mm	15 Nm	13 mm	13 mm	32 mm	100 pc	2004198
HSA-R M8x85 35/25/-	M8	85 mm	9 mm	15 Nm	13 mm	13 mm	47 mm	80 pc	2004199
HSA-R M8x105 55/45/15	M8	105 mm	9 mm	15 Nm	13 mm	13 mm	67 mm	50 pc	2004200
HSA-R M10x68 5/-/-	M10	68 mm	12 mm	25 Nm	17 mm	17 mm	19 mm	50 pc	2004201

Ordering designation	Anchor size	Anchor length	Base plate clearance hole	Required tightening torque	Socket size	Wrench size	Thread length	Sales pack quantity	Item number
HSA-R M10x83 20/10/-	M10	83 mm	12 mm	25 Nm	17 mm	17 mm	34 mm	50 pc	2004202
HSA-R M10x98 35/25/-	M10	98 mm	12 mm	25 Nm	17 mm	17 mm	49 mm	40 pc	2004203
HSA-R M10x113 50/40/10	M10	113 mm	12 mm	25 Nm	17 mm	17 mm	64 mm	40 pc	2004204
HSA-R M10x133 70/60/30	M10	133 mm	12 mm	25 Nm	17 mm	17 mm	84 mm	25 pc	2004205
HSA-R M10x153 90/80/50	M10	153 mm	12 mm	25 Nm	17 mm	17 mm	104 mm	25 pc	2004206
HSA-R M12x85 5/-/-	M12	85 mm	14 mm	50 Nm	19 mm	19 mm	22 mm	25 pc	2004207
HSA-R M12x100 20/5/-	M12	100 mm	14 mm	50 Nm	19 mm	19 mm	37 mm	25 pc	2004208
HSA-R M12x115 35/20/-	M12	115 mm	14 mm	50 Nm	19 mm	19 mm	52 mm	25 pc	2004209
HSA-R M12x145 65/50/15	M12	145 mm	14 mm	50 Nm	19 mm	19 mm	82 mm	25 pc	2004210
HSA-R M12x175 95/80/45	M12	175 mm	14 mm	50 Nm	19 mm	19 mm	112 mm	25 pc	2004211
HSA-R M12x205 125/110/75	M12	205 mm	14 mm	50 Nm	19 mm	19 mm	142 mm	25 pc	2004212
HSA-R M12x225 145/130/95	M12	225 mm	14 mm	50 Nm	19 mm	19 mm	162 mm	25 pc	2004213
HSA-R M16x102 5/-/-	M16	102 mm	18 mm	80 Nm	24 mm	24 mm	26 mm	16 pc	2004214
HSA-R M16x117 20/5/-	M16	117 mm	18 mm	80 Nm	24 mm	24 mm	41 mm	16 pc	2004215
HSA-R M16x137 40/25/-	M16	137 mm	18 mm	80 Nm	24 mm	24 mm	61 mm	16 pc	2004216
HSA-R M16x182 85/70/30	M16	182 mm	18 mm	80 Nm	24 mm	24 mm	106 mm	16 pc	2004217
HSA-R M20x125 10/-/-	M20	125 mm	22 mm	200 Nm	30 mm	30 mm	36 mm	10 pc	2036317
HSA-R M20x170 55/30/-	M20	170 mm	22 mm	200 Nm	30 mm	30 mm	81 mm	10 pc	2036318

## Standard stud anchor HSV



### Key applications and advantages

- Wide range of applications in uncracked concrete
- Made from cold-formed carbon steel, zinc-plated to 5µm
- Two embedment depths for a wide range of fastening thicknesses

### Technical data

<b>Head configuration</b>	Externally threaded
<b>Environmental conditions</b>	Indoor, dry conditions
<b>Type of fastening</b>	Pre-fastening, Through-fastening
<b>Material composition</b>	Steel, zinc-plated (min. 5 µm)
<b>Installation direction</b>	All
<b>Material, corrosion</b>	Steel, zinc-plated
<b>Accessories</b>	HSV/ HSA/ HST/ KB3/ KB-TZ

Ordering designation	Anchor size	Anchor length	Base plate clearance hole	Required tightening torque	Wrench/nut size	Socket size	Wrench size	Sales pack quantity	Item number
HSV M8x75	M8	75 mm	9 mm	15 Nm	13 mm	13 mm	13 mm	100 pc	2041604
HSV M10x90	M10	90 mm	12 mm	30 Nm	17 mm	17 mm	17 mm	50 pc	2041605
HSV M10x100	M10	100 mm	12 mm	30 Nm	17 mm	17 mm	17 mm	50 pc	2041606
HSV M12x100	M12	100 mm	14 mm	50 Nm	19 mm	19 mm	19 mm	30 pc	2041607
HSV M12x110	M12	110 mm	14 mm	50 Nm	19 mm	19 mm	19 mm	30 pc	2041608
HSV M12x120	M12	120 mm	14 mm	50 Nm	19 mm	19 mm	19 mm	30 pc	2041609
HSV M12x150	M12	150 mm	14 mm	50 Nm	19 mm	19 mm	19 mm	25 pc	2041610
HSV M16x120	M16	120 mm	18 mm	100 Nm	24 mm	24 mm	24 mm	16 pc	2041611
HSV M16x140	M16	140 mm	18 mm	100 Nm	24 mm	24 mm	24 mm	16 pc	2041612

## Standard stud anchor HSV-BW



### Key applications and advantages

- Wide range of applications in uncracked concrete
- Made from cold-formed carbon steel, zinc-plated to at least 5µm
- Two embedment depths

### Technical data

<b>Head configuration</b>	Externally threaded
<b>Environmental conditions</b>	Indoor, dry conditions
<b>Type of fastening</b>	Pre-fastening, Through-fastening
<b>Material composition</b>	Steel, zinc-plated (min. 5 µm)
<b>Installation direction</b>	All
<b>Material, corrosion</b>	Steel, zinc-plated
<b>Accessories</b>	HSV/ HSA/ HST/ KB3/ KB-TZ

Ordering designation	Anchor size	Anchor length	Base plate clearance hole	Required tightening torque	Wrench/nut size	Socket size	Wrench size	Sales pack quantity	Item number
HSV-BW M8x75	M8	75 mm	9 mm	15 Nm	13 mm	13 mm	13 mm	100 pc	2041256
HSV-BW M10x90	M10	90 mm	12 mm	30 Nm	17 mm	17 mm	17 mm	50 pc	2041257

Ordering designation	Anchor size	Anchor length	Base plate clearance hole	Required tightening torque	Wrench/nut size	Socket size	Wrench size	Sales pack quantity	Item number
HSV-BW M12x100	M12	100 mm	14 mm	50 Nm	19 mm	19 mm	19 mm	25 pc	2041258
HSV-BW M12x110	M12	110 mm	14 mm	50 Nm	19 mm	19 mm	19 mm	25 pc	2041259
HSV-BW M12x120	M12	120 mm	14 mm	50 Nm	19 mm	19 mm	19 mm	25 pc	2041600
HSV-BW M12x150	M12	150 mm	14 mm	50 Nm	19 mm	19 mm	19 mm	20 pc	2041601
HSV-BW M16x120	M16	120 mm	18 mm	100 Nm	24 mm	24 mm	24 mm	10 pc	2041602
HSV-BW M16x140	M16	140 mm	18 mm	100 Nm	24 mm	24 mm	24 mm	10 pc	2041603

**Machine setting tool for stud anchors HSV/ HSA/ HST/ KB3/ KB-TZ**

**Key applications and advantages**

- Ideal for overhead use
- Drives expansion anchors quickly and easily



Ordering designation	Sales pack quantity	Item number
Setting tool HS-SC M6 - M16	1 pc	2051443
Setting tool HS-SC 150	1 pc	337918
Setting tool HS-SC 300	1 pc	337919

**Torque bar S-TB**



**Key applications and advantages**

- For setting HSA stud anchors with maximum accuracy and productivity
- Reliable ETA approved system using SIW 14-A, 22-A or 22T-A impact wrench
- No more over or undertorquing of HSA stud anchors

**Technical data**

<b>Base material</b>	Concrete (uncracked)
<b>Connection end size</b>	12.7 mm
<b>Drive connection</b>	1/2 in square, female
<b>Drive head</b>	1/2 in, square, male
<b>Material coating/plating/finish</b>	Black
<b>Material composition</b>	Impact-grade chrome molybdenum steel
<b>Tool type</b>	Impact tools, SIW

Ordering designation	Weight	Sales pack quantity	Item number
S-TB HSA M8	0.11 kg	1 pc	423774
S-TB HSA M10	0.12 kg	1 pc	423775
S-TB HSA M12	0.12 kg	1 pc	423776
S-TB HSA M16	0.13 kg	1 pc	423777



### Key applications and advantages

- For medium-duty loads with anchor bolts and threaded rods, e.g. suspension systems for pipes, air ducts, sprinkler systems etc.
- For redundant applications in cracked concrete or single-point applications in uncracked concrete
- "Intelligent" stepped expansion cone allows easy, correct setting even in harder materials
- Available in a variety of sizes for maximized coverage of applications

### Technical data

<b>Head configuration</b>	Inner thread
<b>Environmental conditions</b>	Indoor, dry conditions
<b>Type of fastening</b>	Pre-fastening
<b>Material composition</b>	Steel, zinc-plated (min. 5 µm)
<b>Installation direction</b>	All
<b>Suitable for cracked concrete with redundant fastenings</b>	Yes
<b>PROFIS</b>	Yes
<b>Material, corrosion</b>	Steel, zinc-plated
<b>Accessories</b>	HSD-M, HSD-G

### Approvals

ETA	ETA 02/0032 for HKD drop-in anchor (ETAG 001-04, Option 7)
ETA, Fire resistance	ETA 06/0047 for HKD drop-in anchor multiple applications (ETAG 001-06, Option -)

Approvals and test reports may apply to selected products only. Please refer to the documents for details.



## Drop-in (flush) anchor HKD



Ordering designation	Internal thread size	Thread engagement depth - max.	Base plate clearance hole	Max. tightening torque	Packaging	Anchor length	Thread length	Sales pack quantity	Item number
HKD M6x25	6 mm	13 mm	7 mm	4 Nm	Box	25 mm	12 mm	100 pc	376894
HKD M8x40	8 mm		9 mm	8 Nm	Box	40 mm	18 mm	50 pc	376961
HKD M8x25	8 mm		9 mm	8 Nm	Box	25 mm	12 mm	100 pc	376957
HKD M8x30	8 mm		9 mm	8 Nm	Box	30 mm	15 mm	100 pc	376959
HKD M8x25 bucket	8 mm		9 mm	8 Nm	Bucket	25 mm	12 mm	500 pc	376958
HKD M10x40	10 mm		12 mm	15 Nm	Box	40 mm	18 mm	50 pc	376967
HKD M10x25	10 mm		12 mm	15 Nm	Box	25 mm	12 mm	100 pc	2037453
HKD M10x30	10 mm		12 mm	15 Nm	Box	30 mm	13 mm	100 pc	376965
HKD M10x25 bucket	10 mm		12 mm	15 Nm	Bucket	25 mm	12 mm	500 pc	2037454
HKD M12x50	12 mm		14 mm	35 Nm	Box	50 mm	22 mm	50 pc	378544
HKD M12x25	12 mm		14 mm	35 Nm	Box	25 mm	12 mm	100 pc	378431
HKD M12x50 bucket	12 mm		14 mm	35 Nm	Bucket	50 mm	22 mm	250 pc	378553
HKD M16x65	16 mm	31 mm	18 mm	60 Nm	Box	65 mm	31 mm	25 pc	382941
HKD M20x80	20 mm	42 mm	22 mm	120 Nm	Box	80 mm	42 mm	25 pc	382955

## Setting tool HKD-TE-CX (short)



### Key applications and advantages

- Installation of the Hilti HKD short drop-in anchor for fastening pipes, air ducts and suspended ceilings
- Installation of the HKD short drop-in anchor
- Holes always drilled to the correct depth
- 25 mm anchor length reduces the risk of rebar hits when drilling

### Technical data

<b>Working length</b>	27 mm
<b>Tool type</b>	All TE-C tools
<b>Insert connection end</b>	TE-C (SDS-plus)



Ordering designation	Diameter	Length	Sales pack quantity	Item number
HKD-TE-CX M6 1/4"x25	8 mm	142 mm	1 pc	414472
HKD-TE-CX M8x25	10 mm	162 mm	1 pc	414475

Ordering designation	Diameter	Length	Sales pack quantity	Item number
HKD-TE-CX M10x25	12 mm	162 mm	1 pc	414480
HKD-TE-CX M12x25	15 mm	200 mm	1 pc	2097386

**Setting tool HKD-TE-CX (long)**



**Key applications and advantages**

- Installation of the Hilti HKD short drop-in anchor for fastening pipes, air ducts and suspended ceilings
- Installation of all HKD anchors with embedment depth greater than 30 mm
- Holes always drilled to the correct depth
- Installation of all HKD anchors with embedment depth greater than 30 mm

**Technical data**

<b>Insert connection end</b>	TE-C (SDS-plus)
------------------------------	-----------------



SDS plus

Ordering designation	Diameter	Length	Working length	Sales pack quantity	Item number
HKD-TE-CX M8 5/16"x30	10 mm	169 mm	33 mm	1 pc	2112619
HKD-TE-CX M8x40	10 mm	185 mm	44 mm	1 pc	2112750
HKD-TE-CX M10 3/8"x30	12 mm	169 mm	33 mm	1 pc	2112751
HKD-TE-CX M10 3/8"x40	12 mm	191 mm	44 mm	1 pc	2112752
HKD-TE-CX M12x50 ø15	15 mm	238 mm	55 mm	1 pc	2112753

**Stop drill bit HKD-TE-CX-B (long)**



**Key applications and advantages**

- Spare part for HKD setting tool for embedment depths greater than 30 mm
- Spare part for HKD setting tool for embedment depths greater than 30 mm

**Technical data**

<b>Working mode</b>	Hammer drilling, Drilling only
<b>Insert connection end</b>	TE-C (SDS-plus)



SDS plus

Ordering designation	Diameter	Length	Working length	Sales pack quantity	Item number
HKD-TE-CX-B M8 5/16"x30	10 mm	112 mm	33 mm	1 pc	2112755
HKD-TE-CX-B M8x40	10 mm	123 mm	44 mm	1 pc	2112756
HKD-TE-CX-B M10 3/8"x30	12 mm	107 mm	33 mm	1 pc	2112757
HKD-TE-CX-B M10 3/8"x40	12 mm	123 mm	44 mm	1 pc	2112758
HKD-TE-CX-B M12x50 ø15	15 mm	144 mm	55 mm	1 pc	2112759

**Stop drill bit HKD-TE-CX-B (short)**



**Key applications and advantages**

- Spare part for HKD setting tool (short) for embedment depth of 25 mm
- Spare part for HKD setting tool (short) for embedment depth of 25 mm

**Technical data**

<b>Working length</b>	27 mm
<b>Working mode</b>	Hammer drilling, Drilling only
<b>Insert connection end</b>	TE-C (SDS-plus)



SDS plus

Ordering designation	Diameter	Length	Sales pack quantity	Item number
HKD-TE-CX-B M6x25	8 mm	102 mm	1 pc	2097381
HKD-TE-CX-B M8x25	10 mm	106 mm	1 pc	2097382
HKD-TE-CX-B M10x25	12 mm	101 mm	1 pc	2097383
HKD-TE-CX-B M12x25	15 mm	106 mm	1 pc	2097384

## Drop-in anchor HKD-SR



### Key applications and advantages

- For medium-duty loads with anchor bolts and threaded rods, e.g. suspension systems for pipes, air ducts, sprinkler systems etc.
- For redundant applications in cracked concrete or single-point applications in uncracked concrete
- Available in a variety of sizes for maximized coverage of applications
- Visual check for correct setting when used with Hilti setting tool

### Technical data

<b>Head configuration</b>	Inner thread
<b>Environmental conditions</b>	Outdoor
<b>Type of fastening</b>	Pre-fastening
<b>Material composition</b>	Steel, A4 (SS316)
<b>Installation direction</b>	All
<b>Suitable for cracked concrete with redundant fastenings</b>	Yes
<b>PROFIS</b>	Yes
<b>Material, corrosion</b>	Steel, stainless
<b>Accessories</b>	HSD-M, HSD-G



Ordering designation	Internal thread size	Base plate clearance hole	Max. tightening torque	Packaging	Anchor length	Thread length	Useable thread length	Sales pack quantity	Item number
HKD-SR M6x25	6 mm	7 mm	4 Nm	Box	25 mm	12 mm	12 mm	100 pc	247951
HKD-SR M8x30	8 mm	9 mm	8 Nm	Box	30 mm	15 mm	15 mm	100 pc	247952
HKD-SR M10x40	10 mm	12 mm	15 Nm	Box	40 mm	18 mm	18 mm	50 pc	247953
HKD-SR M12x50	12 mm	14 mm	35 Nm	Box	50 mm	22 mm	22 mm	50 pc	247954
HKD-SR M16x65	16 mm	18 mm	60 Nm	Box	65 mm	31 mm	31 mm	25 pc	247955
HKD-SR M20x80	20 mm	22 mm	120 Nm	Box	80 mm	42 mm	42 mm	25 pc	247956

## Drop-in anchor (metric) HKV



### Key applications and advantages

- Medium-duty anchor for use with anchor bolts and threaded rods, e.g. suspension systems for pipes, air ducts and sprinkler systems etc.
- Fastening diamond core drilling rigs / base plates (M16 only – DD120 and up)
- No collar – can be set at greater depth
- No damage to the thread when tapping in and expanding

### Technical data

<b>Head configuration</b>	Inner thread
<b>Environmental conditions</b>	Indoor, dry conditions
<b>Type of fastening</b>	Pre-fastening
<b>Material composition</b>	Steel, zinc-plated (min. 5 µm)
<b>Installation direction</b>	All
<b>Material, corrosion</b>	Steel, zinc-plated
<b>Accessories</b>	HSD-M, HSD-G

Ordering designation	Internal thread size	Thread engagement depth - max.	Base plate clearance hole	Max. tightening torque	Packaging	Anchor length	Thread length	Sales pack quantity	Item number
HKV M6x25	6 mm	13 mm	7 mm	3 Nm	Bag	25 mm	13 mm	100 pc	384616
HKV M6x25 bucket	6 mm	13 mm	7 mm	3 Nm	Bucket	25 mm	13 mm	1000 pc	384617
HKV M8x30	8 mm		9 mm	7 Nm	Bag	30 mm	15 mm	100 pc	384966
HKV M10x30	10 mm		12 mm	15 Nm	Bag	30 mm	14 mm	50 pc	384968
HKV M10x40	10 mm		12 mm	15 Nm	Bag	40 mm	19 mm	50 pc	384969
HKV M12x50	12 mm	23 mm	14 mm	30 Nm	Bag	50 mm	23 mm	25 pc	384971
HKV M12x50 bucket	12 mm	23 mm	14 mm	30 Nm	Bucket	50 mm	23 mm	250 pc	384972
HKV M16x65	16 mm	32 mm	18 mm	60 Nm	Bag	65 mm	32 mm	25 pc	384973



**Key applications and advantages**

- Base plate fastening in steel and metal applications
- Formwork and bracing
- Temporary applications
- Higher productivity - less drilling and fewer operations than with conventional anchors
- abZ (DiBt) approval for reusability in fresh concrete (10/15/20 Nmm<sup>2</sup>) for temporary applications

Technical data	
<b>Head configuration</b>	Hex head
<b>Material composition</b>	Steel, zinc-plated (min. 5 µm)
<b>Tested/approved for diamond drilling</b>	No
<b>Suitable for cracked concrete with redundant fastenings</b>	Yes
<b>PROFIS</b>	Yes
<b>Material, corrosion</b>	Carbon steel
<b>Accessories</b>	HRG 8/10/14/16
<b>Installation tools</b>	SIW 22T-A 1/2"

Approvals	
DIBt	DiBt Z-21.1-2021 for HUS3 adjustability
ETA	ETA 13/1038 for HUS3-H/C/HF screw anchor (ETAG 13/1038, Option 1)

Approvals and test reports may apply to selected products only. Please refer to the documents for details.



**Screw anchor HUS3-H 8/10/14**



Ordering designation	Anchor size	Base plate clearance hole	Wrench/nut size	Wrench size	Anchor length	Embedment depth 1	Embedment depth 2	Sales pack quantity	Item number
HUS3-H 8x55 5/-/-	8	12 mm	13 mm	13 mm	55 mm	50 mm		50 pc	2079794
HUS3-H 8x65 15/5/-	8	12 mm	13 mm	13 mm	65 mm	50 mm	60 mm	50 pc	2079795
HUS3-H 8x75 25/15/5	8	12 mm	13 mm	13 mm	75 mm	50 mm	60 mm	50 pc	2079796
HUS3-H 8x85 35/25/15	8	12 mm	13 mm	13 mm	85 mm	50 mm	60 mm	50 pc	2079797
HUS3-H 8x100 50/40/30	8	12 mm	13 mm	13 mm	100 mm	50 mm	60 mm	50 pc	2079798
HUS3-H 8x120 70/60/50	8	12 mm	13 mm	13 mm	120 mm	50 mm	60 mm	50 pc	2079799
HUS3-H 8x150 100/90/80	8	12 mm	13 mm	13 mm	150 mm	50 mm	60 mm	50 pc	2079910
HUS3-H 10x60 5/-/-	10	14 mm	15 mm	15 mm	60 mm	55 mm		50 pc	2079911
HUS3-H 10x70 15/-/-	10	14 mm	15 mm	15 mm	70 mm	55 mm		50 pc	2079912
HUS3-H 10x80 25/5/-	10	14 mm	15 mm	15 mm	80 mm	55 mm	75 mm	50 pc	2079913
HUS3-H 10x90 35/15/5	10	14 mm	15 mm	15 mm	90 mm	55 mm	75 mm	50 pc	2079914
HUS3-H 10x100 45/25/15	10	14 mm	15 mm	15 mm	100 mm	55 mm	75 mm	50 pc	2079915
HUS3-H 10x110 55/35/25	10	14 mm	15 mm	15 mm	110 mm	55 mm	75 mm	50 pc	2079916
HUS3-H 10x130 75/55/45	10	14 mm	15 mm	15 mm	130 mm	55 mm	75 mm	50 pc	2079917
HUS3-H 10x150 95/75/65	10	14 mm	15 mm	15 mm	150 mm	55 mm	75 mm	50 pc	2079918
HUS3-H 14x75 10/-/-	14	18 mm	21 mm	21 mm	75 mm	65 mm		16 pc	2079921
HUS3-H 14x100 35/15/-	14	18 mm	21 mm	21 mm	100 mm	65 mm	85 mm	16 pc	2079922
HUS3-H 14x130 65/45/15	14	18 mm	21 mm	21 mm	130 mm	65 mm	85 mm	16 pc	2079923
HUS3-H 14x150 85/65/35	14	18 mm	21 mm	21 mm	150 mm	65 mm	85 mm	16 pc	2079924

Anchor Systems

**Anchor reusability gauge HRG 8/10/14/16**



- Key applications and advantages**
- Temporary applications on all grades of concrete
  - Indicates whether the screw anchor can be reused
  - Always available on site in combination with the SIW 22T-A and SIW 22-A

Technical data	
<b>Head configuration</b>	n/a
<b>Material composition</b>	Steel, zinc-plated (min. 5 µm)
<b>Installation tools</b>	SIW 22T-A 1/2"

Ordering designation	Anchor size	Sales pack quantity	Item number
Check gauge HRG 8	HUS 8	1 pc	2092003
Check gauge HRG 10	HUS 10	1 pc	2090674
Check gauge HRG 14	HUS 14	1 pc	2090675



## Countersunk carbon steel screw anchor HUS3-C 8/10



### Key applications and advantages

- Railings and balustrades
- Architectural metal
- ETA approval for cracked and un-cracked concrete
- Seismic approval ETA C1

### Technical data

<b>Head configuration</b>	Countersunk Torx
<b>Material composition</b>	Steel, zinc-plated (min. 5 µm)
<b>Tested/approved for diamond drilling</b>	No
<b>Suitable for cracked concrete with redundant fastenings</b>	Yes
<b>PROFIS</b>	Yes
<b>Material, corrosion</b>	Carbon steel
<b>Accessories</b>	S-IS
<b>Installation tools</b>	SIW 22T-A 1/2"



Ordering designation	Anchor size	Base plate clearance hole	Bit size	Anchor length	Embedment depth 1	Embedment depth 2	Embedment depth 3	Sales pack quantity	Item number
HUS3-C 8x65 15/-/-	8	12 mm	T45	65 mm	50 mm			50 pc	2079931
HUS3-C 8x75 25/15/-	8	12 mm	T45	75 mm	50 mm	60 mm	70 mm	50 pc	2079932
HUS3-C 8x85 35/25/15	8	12 mm	T45	85 mm	50 mm	60 mm	70 mm	50 pc	2079933
HUS3-C 10x70 15/-/-	10	14 mm	T50	70 mm	55 mm			50 pc	2079934
HUS3-C 10x90 35/15/-	10	14 mm	T50	90 mm	55 mm	75 mm		50 pc	2079935
HUS3-C 10x100 45/25/15	10	14 mm	T50	100 mm	55 mm	75 mm	85 mm	50 pc	2079936

## Screw anchor HUS3-HF 8/10/14



### Key applications and advantages

- Base plate fastening in steel and metal applications
- Structural steel
- Railings and handrails
- Higher productivity - less drilling and fewer operations than with conventional anchors
- Multilayer coating (≥14 µm) for additional corrosion resistance

### Technical data

<b>Head configuration</b>	Hex head
<b>Material composition</b>	Steel, multilayer coating
<b>Tested/approved for diamond drilling</b>	No
<b>Suitable for cracked concrete with redundant fastenings</b>	Yes
<b>PROFIS</b>	Yes
<b>Material, corrosion</b>	Steel, sherardised / hot-dip galvanised
<b>Installation tools</b>	SIW 22T-A 1/2"



Ordering designation	Anchor size	Base plate clearance hole	Wrench/nut size	Socket size	Wrench size	Anchor length	Embedment depth 1	Sales pack quantity	Item number
HUS3-HF 10x60 5/-/-	10	14 mm	15 mm	15 mm	15 mm	60 mm	55 mm	50 pc	2079925
HUS3-HF 10x80 25/5/	10	14 mm	15 mm	15 mm	15 mm	80 mm	55 mm	50 pc	2079926
HUS3-HF 10x100 45/25/15	10	14 mm	15 mm	15 mm	15 mm	100 mm	55 mm	50 pc	2079927
HUS3-HF 10x110 55/35/25	10	14 mm	15 mm	15 mm	15 mm	110 mm	55 mm	50 pc	2079928
HUS3-HF 14x75 10/-/-	14	18 mm	21 mm	21 mm	21 mm	75 mm	65 mm	16 pc	2079929
HUS3-HF 14x100 35/15/-	14	18 mm	21 mm	21 mm	21 mm	100 mm	65 mm	16 pc	2079930

**Screw anchor HUS-HR**



**Key applications and advantages**

- Installing railings
- Anchoring facade panels
- Fitting installation channels
- Seismic approval ETA C1
- Higher productivity - less drilling and fewer operations than with conventional anchors

**Technical data**

<b>Head configuration</b>	Hex head
<b>Environmental conditions</b>	Indoor, damp conditions, Indoor, dry conditions, Outdoor
<b>Type of fastening</b>	Through-fastening
<b>Material composition</b>	Steel, A4 (SS316)
<b>Installation direction</b>	All
<b>Tested/approved for diamond drilling</b>	No
<b>Suitable for cracked concrete with redundant fastenings</b>	Yes
<b>PROFIS</b>	Yes
<b>Material, corrosion</b>	Steel, stainless
<b>Installation tools</b>	SIW 22T-A 1/2", SIW 14-A, SIW 22-A



Ordering designation	Anchor size	Base plate clearance hole	Wrench size	Anchor length	Embedment depth 1	Embedment depth 2	Fastening thickness at embed.1	Sales pack quantity	Item number
HUS-HR 6x35 5/-/-	6	9 mm	13 mm	35 mm	30 mm		5 mm	50 pc	290005
HUS-HR 6x45 15/-	6	9 mm	13 mm	45 mm	30 mm		15 mm	50 pc	290011
HUS-HR 8x65 15/5/-	8	12 mm	13 mm	65 mm	50 mm	60 mm	15 mm	25 pc	290030
HUS-HR 10x65 5/-/-	10	14 mm	15 mm	65 mm	60 mm		5 mm	25 pc	290062



### Key applications and advantages

- Piping or ventilation applications where channels are fastened directly to the ceiling
- Fastening handrails, railings and other ornamental steelwork
- Suitable for serial applications
- ETA approval - also for cracked concrete

Reduced edge and spacing distances

### Technical data

<b>Head configuration</b>	Torx hex head
<b>Environmental conditions</b>	Indoor, dry conditions
<b>Type of fastening</b>	Through-fastening
<b>Material composition</b>	Steel, zinc-plated (min. 5 µm)
<b>Installation direction</b>	All
<b>Suitable for cracked concrete with redundant fastenings</b>	Yes
<b>PROFIS</b>	Yes
<b>Material, corrosion</b>	Steel, zinc-plated
<b>Installation tools</b>	SID 14-A, SIW 14-A, SID 22-A, SIW 22-A

### Approvals

ETA	ETA 13/1038 for HUS3-H/C/HF screw anchor (ETAG 13/1038, Option 1)
ETA, Fire resistance	ETA 10/0005 for HUS3 screw anchor size 6 multiple applications (ETAG 001-06, Option -)
ETA, Fire resistance, Seismic	ETA 08/0307 for HUS screw anchor single point (ETAG 001-03, Option 1)

Approvals and test reports may apply to selected products only. Please refer to the documents for details.



## Screw anchor HUS-H



Ordering designation	Anchor size	Base plate clearance hole	Wrench size	Bit size	Anchor length	Embedment depth 1	Embedment depth 2	Sales pack quantity	Item number
HUS3-H 6x60/5/25	6	9 mm	13 mm	T30	60 mm	35 mm	55 mm	100 pc	416736
HUS3-H 6x80/25/45	6	9 mm	13 mm	T30	80 mm	35 mm	55 mm	100 pc	416737

## Screw anchor HUS-A



### Key applications and advantages

- Higher productivity - less drilling and fewer operations than with conventional anchors
- ETA approval - also for cracked concrete

### Technical data

<b>Head configuration</b>	Externally threaded
<b>Environmental conditions</b>	Indoor, dry conditions
<b>Type of fastening</b>	Pre-fastening
<b>Material composition</b>	Steel, zinc-plated (min. 5 µm)
<b>Installation direction</b>	All
<b>Suitable for cracked concrete with redundant fastenings</b>	Yes
<b>PROFIS</b>	Yes
<b>Material, corrosion</b>	Steel, zinc-plated
<b>Installation tools</b>	SID 14-A, SIW 14-A, SID 22-A, SIW 22-A



Ordering designation	Anchor size	Base plate clearance hole	Wrench size	Anchor length	Thread length	Embedment depth 1	Embedment depth 2	Sales pack quantity	Item number
HUS3-A 6x35 M10/21	6 / M10	9 mm	13 mm	35 mm	21 mm	35 mm		100 pc	416742
HUS3-A 6x35 M8/16	6 / M8	9 mm	13 mm	35 mm	18 mm	35 mm		100 pc	416741
HUS3-A 6x55 M10/21	6 / M10	9 mm	13 mm	55 mm	21 mm	35 mm	55 mm	100 pc	416744
HUS3-A 6x55 M8/16	6 / M8	9 mm	13 mm	55 mm	18 mm	35 mm	55 mm	100 pc	416743

### Screw anchor HUS-I

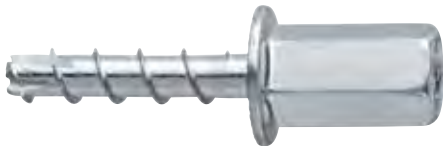

#### Key applications and advantages

- Various piping and ventilation applications
- Rod hangers for single or multiple pipes
- Suitable for serial applications
- M8 and M10 internally threaded heads for direct attachment of threaded rods
- M8 and M10 dual boss allows smaller inventories One product for 2 diameters

#### Technical data

<b>Head configuration</b>	Inner thread
<b>Environmental conditions</b>	Indoor, dry conditions
<b>Type of fastening</b>	Pre-fastening
<b>Material composition</b>	Steel, zinc-plated (min. 5 µm)
<b>Installation direction</b>	All
<b>Suitable for cracked concrete with redundant fastenings</b>	Yes
<b>PROFIS</b>	Yes
<b>Material, corrosion</b>	Steel, zinc-plated
<b>Installation tools</b>	SID 14-A, SIW 14-A, SID 22-A, SIW 22-A
<b>Internal thread size</b>	8 mm



Ordering designation	Anchor size	Thread engagement depth - min.	Wrench size	Anchor length	Embedment depth 1	Drilling depth at embed. 1	Sales pack quantity	Item number
HUS3-I 6x35 M8/M10	6	10 mm	13 mm	35 mm	35 mm	45 mm	100 pc	416740

### Screw anchor HUS-P



#### Key applications and advantages

- Piping or ventilation applications with channels fastened directly to the ceiling
- Various applications with ornamental fittings in steel such as handrails or railings
- Suitable for serial applications
- ETA approval - also for cracked concrete
- Neat head appearance No extra time spent finishing

#### Technical data

<b>Head configuration</b>	Round head
<b>Environmental conditions</b>	Indoor, dry conditions
<b>Type of fastening</b>	Through-fastening
<b>Material composition</b>	Steel, zinc-plated (min. 5 µm)
<b>Installation direction</b>	All
<b>Suitable for cracked concrete with redundant fastenings</b>	Yes
<b>PROFIS</b>	Yes
<b>Material, corrosion</b>	Steel, zinc-plated
<b>Installation tools</b>	SID 14-A, SIW 14-A, SID 22-A, SIW 22-A



Ordering designation	Anchor size	Base plate clearance hole	Bit size	Anchor length	Embedment depth 1	Embedment depth 2	Fastening thickness at embed.1	Sales pack quantity	Item number
HUS3-P 6x40/5	6	9 mm	T30	40 mm	35 mm		5 mm	100 pc	416745
HUS3-P 6x60/5/25	6	9 mm	T30	60 mm	35 mm	55 mm	25 mm	100 pc	416746

## Frame screw anchor HUS-S



### Key applications and advantages

- Big productivity gains and labour savings
- Removable

### Technical data

<b>Head configuration</b>	Socket head cap (Allen head)
<b>Environmental conditions</b>	Indoor, dry conditions
<b>Type of fastening</b>	Through-fastening
<b>Material composition</b>	Steel, zinc-plated (min. 5 µm)
<b>Installation direction</b>	All
<b>Suitable for cracked concrete with redundant fastenings</b>	Yes
<b>Material, corrosion</b>	Steel, zinc-plated
<b>Installation tools</b>	SID 14-A

Ordering designation	Anchor size	Base plate clearance hole	Bit size	Anchor length	Embedment depth 1	Embedment depth 2	Embedment depth 3	Sales pack quantity	Item number
HUS-S 6x100	6	9 mm	T30	100 mm	34 mm	44 mm	64 mm	100 pc	<b>381406</b>
HUS-S 6x120	6	9 mm	T30	120 mm	34 mm	44 mm	64 mm	100 pc	<b>381407</b>
HUS-S 6x160	6	9 mm	T30	160 mm	34 mm	44 mm	64 mm	100 pc	<b>381409</b>

### Coil anchor HCA



Technical data	
<b>Head configuration</b>	Hex head
<b>Environmental conditions</b>	Indoor, dry conditions
<b>Type of fastening</b>	Through-fastening
<b>Material composition</b>	Steel, zinc-plated (min. 5 µm)
<b>Installation direction</b>	All
<b>Material, corrosion</b>	Steel, zinc-plated



#### Key applications and advantages

- Fastening braces to support tilt-up and formwork
- Non-specified, temporary fastenings
- Multiple-use design offers practical and cost-effective fastening solution
- Easily removable because only the coil remains in the hole

Ordering designation	Anchor diameter (imperial)	Base plate clearance hole	Required tightening torque	Wrench/nut size	Wrench size	Anchor length	Standard embedment depth	Sales pack quantity	Item number
HCA 5/8x3 1/2	5/8 in	18 mm	180 Nm	24 mm	24 mm	90 mm	60 mm	25 pc	252014

### Coil HCT

#### Key applications and advantages

- Fastening braces to support tilt-ups and formwork
- Temporary fastenings for which no approval is required
- Simple accessory that allows the HCA anchor to be reused in a new hole



Ordering designation	Sales pack quantity	Item number
HCT 5/8	100 pc	255989

## Sleeve anchor (hex head) HLC-H



### Key applications and advantages

- Suitable for a large range of temporary applications, fastening small items etc.
- Variety of lengths and sizes for a multitude of applications
- Pre-assembled anchor for fast, easy installation

### Technical data

<b>Head configuration</b>	Hex head
<b>Environmental conditions</b>	Indoor, dry conditions
<b>Type of fastening</b>	Pre-fastening, Through-fastening
<b>Material composition</b>	Steel, 8.8 grade, zinc-plated (min. 5 µm)
<b>Installation direction</b>	All
<b>Material, corrosion</b>	Steel, zinc-plated
<b>Accessories</b>	S-IS

Ordering designation	Anchor diameter (imperial)	Anchor size	Anchor length	Base plate clearance hole	Required tightening torque	Wrench/nut size	Wrench size	Sales pack quantity	Item number
HLC-H 8x40/10	5/16 in	8 mm	40 mm	10 mm	8 Nm	10 mm	10 mm	100 pc	385836
HLC-H 8x70/40	5/16 in	8 mm	70 mm	10 mm	8 Nm	10 mm	10 mm	100 pc	385840
HLC-H 10x40/5	3/8 in	10 mm	40 mm	12 mm	25 Nm	13 mm	13 mm	50 pc	385841
HLC-H 10x80/45	3/8 in	10 mm	80 mm	12 mm	25 Nm	13 mm	13 mm	50 pc	385845
HLC-H 10x100/65	3/8 in	10 mm	100 mm	12 mm	25 Nm	13 mm	13 mm	50 pc	385847
HLC-H 12x55/15	1/2 in	12 mm	55 mm	14 mm	40 Nm	17 mm	17 mm	50 pc	385848
HLC-H 12x75/35	1/2 in	12 mm	75 mm	14 mm	40 Nm	17 mm	17 mm	50 pc	385849
HLC-H 12x100/60	1/2 in	12 mm	100 mm	14 mm	40 Nm	17 mm	17 mm	25 pc	385852
HLC-H 16x60/10	5/8 in	16 mm	60 mm	18 mm	50 Nm	19 mm	19 mm	10 pc	385853
HLC-H 16x100/50	5/8 in	16 mm	100 mm	18 mm	50 Nm	19 mm	19 mm	15 pc	385854

## Sleeve anchor (hex head) HLC



### Key applications and advantages

- Suitable for a large range of temporary applications, fastening small items etc.
- Variety of lengths and sizes for a multitude of applications
- Pre-assembled anchor for fast, easy installation

### Technical data

<b>Head configuration</b>	Hex head
<b>Environmental conditions</b>	Indoor, dry conditions
<b>Type of fastening</b>	Pre-fastening, Through-fastening
<b>Material composition</b>	Steel, zinc-plated (min. 5 µm)
<b>Installation direction</b>	All
<b>Material, corrosion</b>	Steel, zinc-plated

Ordering designation	Anchor size	Anchor length	Base plate clearance hole	Required tightening torque	Wrench/nut size	Wrench size	Max. fixture thickness at standard embedment depth	Sales pack quantity	Item number
HLC 6,5x25/5	6.5 mm	25 mm	7 mm	5 Nm	8 mm	8 mm	5 mm	100 pc	385811
HLC 6,5x40/20	6.5 mm	40 mm	7 mm	5 Nm	8 mm	8 mm	20 mm	100 pc	385812
HLC 6,5x60/40	6.5 mm	60 mm	7 mm	5 Nm	8 mm	8 mm	40 mm	100 pc	385813
HLC 8x40/10	8 mm	40 mm	10 mm	8 Nm	10 mm	10 mm	10 mm	100 pc	385814
HLC 8x55/25	8 mm	55 mm	10 mm	8 Nm	10 mm	10 mm	25 mm	100 pc	385816
HLC 8x70/40	8 mm	70 mm	10 mm	8 Nm	10 mm	10 mm	40 mm	100 pc	385817
HLC 8x85/55	8 mm	85 mm	10 mm	8 Nm	10 mm	10 mm	55 mm	100 pc	385818
HLC 10x40/5	10 mm	40 mm	12 mm	25 Nm	13 mm	13 mm	5 mm	50 pc	385819
HLC 10x50/15	10 mm	50 mm	12 mm	25 Nm	13 mm	13 mm	15 mm	50 pc	385820
HLC 10x60/25	10 mm	60 mm	12 mm	25 Nm	13 mm	13 mm	25 mm	50 pc	385822
HLC 10x80/45	10 mm	80 mm	12 mm	25 Nm	13 mm	13 mm	45 mm	50 pc	385823
HLC 10x100/65	10 mm	100 mm	12 mm	25 Nm	13 mm	13 mm	65 mm	50 pc	385824
HLC 12x55/15	12 mm	55 mm	14 mm	40 Nm	15 mm	15 mm	15 mm	50 pc	385825
HLC 12x75/35	12 mm	75 mm	14 mm	40 Nm	15 mm	15 mm	35 mm	50 pc	385827
HLC 12x100/60	12 mm	100 mm	14 mm	40 Nm	15 mm	15 mm	60 mm	25 pc	385829
HLC 16x60/10	16 mm	60 mm	18 mm	50 Nm	19 mm	19 mm	10 mm	25 pc	385830
HLC 16x100/50	16 mm	100 mm	18 mm	50 Nm	19 mm	19 mm	50 mm	10 pc	385831
HLC 16x140/90	16 mm	140 mm	18 mm	50 Nm	19 mm	19 mm	90 mm	10 pc	385832
HLC 20x115/60	20 mm	115 mm	21 mm	80 Nm	24 mm	24 mm	60 mm	10 pc	385834

### Sleeve anchor (inner thread) HLC-A



#### Key applications and advantages

- Suitable for a large range of applications
- Consists of sleeve and cone for tailor made” solutions”
- Suitable for various base materials thanks to the expansion principle

#### Technical data

<b>Head configuration</b>	Inner thread
<b>Environmental conditions</b>	Indoor, dry conditions
<b>Type of fastening</b>	Pre-fastening, Through-fastening
<b>Material composition</b>	Steel, zinc-plated (min. 5 µm)
<b>Installation direction</b>	All
<b>Material, corrosion</b>	Steel, zinc-plated

Ordering designation	Anchor size	Anchor length	Base plate clearance hole	Required tightening torque	Max. fixture thickness at standard embedment depth	Drilling depth	Sales pack quantity	Item number
HLC-A 8x36	8 mm	36 mm	10 mm	8 Nm	10 mm	40 mm	100 pc	385878
HLC-A 10x35	10 mm	35 mm	12 mm	25 Nm	4 mm	50 mm	50 pc	385879
HLC-A 12x48	12 mm	48 mm	14 mm	40 Nm	15 mm	65 mm	50 pc	385880
HLC-A 16x100	16 mm	100 mm	18 mm	50 Nm	59 mm	75 mm	10 pc	385881

### Sleeve anchor (closed eyebolt) HLC-EC



#### Key applications and advantages

- Pre-assembled anchor for fast, easy installation
- Eyelet version

#### Technical data

<b>Head configuration</b>	Closed eye bolt
<b>Environmental conditions</b>	Indoor, dry conditions
<b>Material composition</b>	Steel, zinc-plated (min. 5 µm)
<b>Installation direction</b>	All
<b>Material, corrosion</b>	Steel, zinc-plated

Ordering designation	Anchor size	Anchor length	Base plate clearance hole	Required tightening torque	Max. fixture thickness at standard embedment depth	Drilling depth	Sales pack quantity	Item number
HLC-EC 8x40	8 mm	40 mm	10 mm	8 Nm	14 mm	40 mm	50 pc	385871
HLC-EC 10x50	10 mm	50 mm	12 mm	25 Nm	20 mm	50 mm	50 pc	385872
HLC-EC 16x100	16 mm	100 mm	18 mm	50 Nm	59 mm	75 mm	10 pc	385873
HLC-EC 16x160	16 mm	160 mm	18 mm	50 Nm	119 mm	75 mm	15 pc	385874

### Sleeve anchor (open eyebolt) HLC-EO



#### Key applications and advantages

- Suitable for a large range of applications in different base materials
- Pre-assembled anchor for fast, easy installation
- Hook version

#### Technical data

<b>Head configuration</b>	Open eye bolt
<b>Environmental conditions</b>	Indoor, dry conditions
<b>Material composition</b>	Steel, zinc-plated (min. 5 µm)
<b>Installation direction</b>	All
<b>Material, corrosion</b>	Steel, zinc-plated

Ordering designation	Anchor size	Anchor length	Base plate clearance hole	Required tightening torque	Drilling depth	Sales pack quantity	Item number
HLC-EO 8x40	8 mm	40 mm	10 mm	8 Nm	40 mm	50 pc	385875



## Sleeve anchor (tie wire) HLC-T



### Key applications and advantages

- Suitable for different base materials
- Pre-assembled anchor for fast, easy installation
- Ideal for through-fastening applications

### Technical data

<b>Head configuration</b>	Tie wire
<b>Environmental conditions</b>	Indoor, dry conditions
<b>Material composition</b>	Steel, 8.8 grade, zinc-plated (min. 5 µm)
<b>Installation direction</b>	All
<b>Material, corrosion</b>	Steel, zinc-plated

Ordering designation	Anchor size	Anchor length	Base plate clearance hole	Required tightening torque	Drilling depth	Sales pack quantity	Item number
HLC-T 6,5x25	6.5 mm	25 mm	7 mm	5 Nm	30 mm	50 pc	385877

## Sleeve anchor (counter sunk) HLC-SK



### Key applications and advantages

- Suitable for various base materials thanks to the expansion principle
- Variety of lengths and sizes for a multitude of applications
- Pre-assembled anchor for fast, easy installation

### Technical data

<b>Head configuration</b>	Countersunk
<b>Environmental conditions</b>	Indoor, dry conditions
<b>Type of fastening</b>	Through-fastening
<b>Material composition</b>	Steel, 8.8 grade, zinc-plated (min. 5 µm)
<b>Installation direction</b>	All
<b>Material, corrosion</b>	Steel, zinc-plated

Ordering designation	Anchor size	Anchor length	Base plate clearance hole	Required tightening torque	Bit size	Max. fixture thickness at standard embedment depth	Drilling depth	Sales pack quantity	Item number
HLC-SK 6,5x45/20	6.5 mm	45 mm	7 mm	5 Nm	PZ3	20 mm	30 mm	100 pc	385856
HLC-SK 6,5x65/40	6.5 mm	65 mm	7 mm	5 Nm	PZ3	40 mm	30 mm	100 pc	385857
HLC-SK 6,5x85/60	6.5 mm	85 mm	7 mm	5 Nm	PZ3	60 mm	30 mm	100 pc	385858
HLC-SK 8x60/25	8 mm	60 mm	10 mm	8 Nm	T30	25 mm	40 mm	100 pc	385859
HLC-SK 8x75/40	8 mm	75 mm	10 mm	8 Nm	T30	40 mm	40 mm	100 pc	385860
HLC-SK 8x90/55	8 mm	90 mm	10 mm	8 Nm	T30	55 mm	40 mm	100 pc	385861
HLC-SK 10x45/5	10 mm	45 mm	12 mm	25 Nm	T40	5 mm	50 mm	50 pc	385862
HLC-SK 10x85/45	10 mm	85 mm	12 mm	25 Nm	T40	45 mm	50 mm	50 pc	385863
HLC-SK 10x105/65	10 mm	105 mm	12 mm	25 Nm	T40	65 mm	50 mm	50 pc	385864
HLC-SK 10x130/95	10 mm	130 mm	12 mm	25 Nm	T40	95 mm	50 mm	25 pc	385865
HLC-SK 12x80/35	12 mm	80 mm	14 mm	40 Nm	T40	35 mm	65 mm	50 pc	385866

## Metal frame anchor HT



### Key applications and advantages

- Stress-free fastening through in-place frames
- Expansion cone cannot be lost

### Technical data

<b>Head configuration</b>	Countersunk, Flat head
<b>Environmental conditions</b>	Indoor, dry conditions
<b>Type of fastening</b>	Through-fastening
<b>Material composition</b>	Steel, 4.6 grade, zinc-plated (min. 5 µm), Sheet steel, sendzimir zinc-plated to approx. 16µm
<b>Installation direction</b>	All
<b>Material, corrosion</b>	Steel, zinc-plated



Ordering designation	Anchor size	Anchor length	Bit size	Standard embedment depth	Max. fixture thickness at standard embedment depth	Drilling depth	Sales pack quantity	Item number
HT 10X72	10 mm	72 mm	PZ3	30 mm	42 mm	50 mm	100 pc	369263
HT 10X92	10 mm	92 mm	PZ3	30 mm	62 mm	50 mm	100 pc	369264
HT 10X112	10 mm	112 mm	PZ3	30 mm	82 mm	50 mm	100 pc	369265
HT 10X132	10 mm	132 mm	PZ3	30 mm	102 mm	50 mm	100 pc	369266
HT 10X152	10 mm	152 mm	PZ3	30 mm	122 mm	50 mm	100 pc	369267
HT 10X182	10 mm	182 mm	PZ3	30 mm	152 mm	50 mm	100 pc	369268
HT 10X202	10 mm	202 mm	PZ3	30 mm	172 mm	50 mm	100 pc	369269



**Key applications and advantages**

- Fastening battens, channels, panels, decorative items, etc. into hollow brick and gypsum panels.
- Pre-assembled with screw
- Ergonomic setting tool for thread sizes M4 to M8

Technical data	
Head configuration	Round head
Environmental conditions	Indoor, dry conditions
Type of fastening	Pre-fastening, Through-fastening
Material composition	Steel, zinc-plated
Installation direction	All
Additional product information	With pre-assembled screw
Material, corrosion	Steel, zinc-plated
Accessories	HHD, HHD Pro

**Cavity anchor HHD-S**



Ordering designation	Anchor size	Anchor length	Bit size	Max. fixture thickness at standard embedment depth	Sales pack quantity	Item number
HHD-S M4/4X20	M4	20 mm	PH1	15 mm	100 pc	332060
HHD-S M4/6X32	M4	32 mm	PH1	25 mm	100 pc	332061
HHD-S M4/12X38	M4	38 mm	PH1	25 mm	100 pc	332062
HHD-S M4/19X45	M4	45 mm	PH1	25 mm	50 pc	332063
HHD-S M5/8X38	M5	38 mm	PH2	25 mm	100 pc	332065
HHD-S M5/12X52	M5	52 mm	PH2	30 mm	50 pc	332066
HHD-S M5/25X65	M5	65 mm	PH2	30 mm	50 pc	332067
HHD-S M6/9X38	M6	38 mm	PH3	20 mm	100 pc	332069
HHD-S M6/12X52	M6	52 mm	PH3	30 mm	50 pc	332070
HHD-S M6/24X65	M6	65 mm	PH3	30 mm	50 pc	332071
HHD-S M6/40X80	M6	80 mm	PH3	30 mm	50 pc	332072

**Cavity anchor with hex head bolt HHD-S**



Key applications and advantages	
■ Fastening battens, channels, panels, decorative items, etc. to hollow brick and gypsum panels	
■ With pre-assembled hex head bolt	
■ Ergonomic setting tool	

Technical data	
Head configuration	Hex head
Material, corrosion	Steel, zinc-plated
Accessories	HHD, HHD Pro

Ordering designation	Anchor size	Anchor length	Wrench/nut size	Socket size	Max. fixture thickness at standard embedment depth	Sales pack quantity	Item number
HHD-S M8/12X54	M8	54 mm	13 mm	13 mm	30 mm	50 pc	332073
HHD-S M8/24X66	M8	66 mm	13 mm	13 mm	30 mm	50 pc	332074
HHD-S M8/40X83	M8	83 mm	13 mm	13 mm	35 mm	50 pc	332075

**Setting tool HHD**



Key applications and advantages	
■ Setting tool for HHD-S and HHD cavity anchors	

Technical data	
Dispenser, setting tool, accessory, tester type	Setting tools

Ordering designation	Sales pack quantity	Item number
Setting tool HHD-S	1 pc	332076

## Wedge anchor DBZ



### Key applications and advantages

- Suspensions from concrete ceilings with slit-steel straps, punched band, nonius system hangers or wood battens
- For redundant applications in cracked concrete or single-point applications in uncracked concrete
- Simple and fast through-fastening
- Impact expansion by hammering in, no setting tool is needed

### Technical data

<b>Head configuration</b>	Flat head
<b>Environmental conditions</b>	Indoor, dry conditions
<b>Type of fastening</b>	Through-fastening
<b>Material composition</b>	Steel, zinc-plated (min. 5 µm)
<b>Installation direction</b>	All
<b>Suitable for cracked concrete with redundant fastenings</b>	Yes
<b>Material, corrosion</b>	Steel, zinc-plated



Ordering designation	Anchor size	Anchor length	Base plate clearance hole	Standard embedment depth	Max. fixture thickness at standard embedment depth	Thickness fastened - min.	Drilling depth	Sales pack quantity	Item number
DBZ 6/4.5	6 mm	40 mm	7 mm	32 mm	5 mm	0 mm	40 mm	100 pc	256312
DBZ 6/35	6 mm	71 mm	7 mm	32 mm	35 mm	5 mm	55 mm	100 pc	256311

## Aerated concrete anchor HPD



### Key applications and advantages

- Virtually all kinds of light-duty fastening on aerated concrete
- MQ channels
- Sprinkler systems
- Fast and easy setting procedure, no drilling required
- Always set correctly thanks to the blue safety mark on the rod

### Technical data

<b>Head configuration</b>	Externally threaded, Inner thread
<b>Environmental conditions</b>	Indoor, dry conditions
<b>Type of fastening</b>	Pre-fastening
<b>Material composition</b>	Steel, zinc-plated (min. 5 µm)
<b>Installation direction</b>	All
<b>Material, corrosion</b>	Steel, zinc-plated
<b>Accessories</b>	HPE-G/-M



Ordering designation	Anchor size	Anchor length	Internal thread size	Base plate clearance hole	Required tightening torque	Wrench/nut size	Socket size	Sales pack quantity	Item number
HPD M8/20	M8	98 mm	8 mm	9 mm	5 Nm	13 mm	13 mm	25 pc	373477
HPD M10/30	M10	110 mm	10 mm	12 mm	8 Nm		17 mm	25 pc	373479

## Sleeve anchor with screw and washer HAM with bolt



### Key applications and advantages

- Internally-threaded solution for all solid base materials
- Works on all solid base materials
- Protective plastic ring eliminates deformation caused by hammering

### Technical data

<b>Head configuration</b>	Hex head
<b>Environmental conditions</b>	Indoor, dry conditions
<b>Type of fastening</b>	Pre-fastening
<b>Installation direction</b>	All
<b>Material, corrosion</b>	Steel, zinc-plated

Ordering designation	Anchor size	Anchor length	Internal thread size	Base plate clearance hole	Thread length	Useable thread length	Standard embedment depth	Sales pack quantity	Item number
HAM M6X50	M6	60 mm	6 mm	7 mm	5 mm	5 mm	60 mm	100 pc	305857
HAM M8X60	M8	75 mm	8 mm	9 mm	10 mm	10 mm	75 mm	50 pc	305858
HAM M10X80	M10	85 mm	10 mm	12 mm	15 mm	15 mm	85 mm	25 pc	305859
HAM M12X90	M12	95 mm	12 mm	14 mm	20 mm	20 mm	95 mm	25 pc	305860



Technical data	
Head configuration	Inner thread
Environmental conditions	Indoor, dry conditions
Type of fastening	Pre-fastening
Installation direction	All
Material, corrosion	Steel, zinc-plated

**Key applications and advantages**

- Internally-threaded solution for all solid base materials
- Environmentally friendly coating used as a substitute for blue chromate
- Protective plastic ring eliminates deformation caused by hammering

**Hard sleeve anchor HAM without bolt**



Ordering designation	Anchor size	Anchor length	Internal thread size	Base plate clearance hole	Thread length	Useable thread length	Standard embedment depth	Sales pack quantity	Item number
HAM M6	M6	60 mm	6 mm	7 mm	5 mm	5 mm	60 mm	100 pc	305853
HAM M8	M8	75 mm	8 mm	9 mm	10 mm	10 mm	75 mm	50 pc	305854
HAM M10	M10	85 mm	10 mm	12 mm	15 mm	15 mm	85 mm	25 pc	305855
HAM M12	M12	95 mm	12 mm	14 mm	20 mm	20 mm	95 mm	25 pc	305856

**Hook and ring anchors HA 8**



- Key applications and advantages**
- Suspensions from concrete ceilings e.g. suspended ceilings etc.
  - Time-saving, easy manual expansion
  - Reliable thanks to automatic follow-up expansion

Technical data	
Head configuration	Closed eye bolt, Open eye bolt
Environmental conditions	Indoor, dry conditions
Type of fastening	Pre-fastening
Material composition	Steel, zinc-plated (min. 5 µm)
Installation direction	All
Suitable for cracked concrete with redundant fastenings	Yes
Material, corrosion	Steel, zinc-plated



Ordering designation	Anchor size	Anchor length	Standard embedment depth	Drilling depth	Sales pack quantity	Item number
HA 8 H1	8 mm	66 mm	40 mm	50 mm	100 pc	57036
HA 8 R1	8 mm	66 mm	40 mm	50 mm	100 pc	57059

## Frame anchor with countersunk head HRD-C



### Key applications and advantages

- Typical applications for metal fabricators such as fastening handrails, window bars, railings, balustrades, etc.
- Fastening wooden substructures for ventilated facades
- Fastening door and window frames
- Flexible embedment depth (approved at 50 mm and 70 mm embedment depth) - the ideal anchor for a huge range of applications in virtually all base materials
- Suitable for fastening thicknesses up to 260 mm (anchor lengths from 60 mm to 310 mm)

### Technical data

<b>Anchor type</b>	Anchor with screw
<b>Head configuration</b>	Countersunk
<b>Environmental conditions</b>	Indoor, dry conditions
<b>Type of fastening</b>	Through-fastening
<b>Material composition</b>	Steel, zinc-plated (min. 5 µm), Polyamide
<b>Suitable for cracked concrete with redundant fastenings</b>	Yes
<b>Material, corrosion</b>	Steel, zinc-plated
<b>Installation temperature - min.</b>	-10 °C



Ordering designation	Anchor size	Anchor length	Base plate clearance hole	Screw head diameter	Bit size	Embedment depth 1	Embedment depth 2	Sales pack quantity	Item number
HRD-C 8x60	8 mm	60 mm	9 mm	11 mm	T30	50 mm		50 pc	202341
HRD-C 8x80	8 mm	80 mm	9 mm	11 mm	T30	50 mm		50 pc	202342
HRD-C 8x100	8 mm	100 mm	9 mm	11 mm	T30	50 mm		50 pc	202343
HRD-C 8x120	8 mm	120 mm	9 mm	11 mm	T30	50 mm		50 pc	202344
HRD-C 8x140	8 mm	140 mm	9 mm	11 mm	T30	50 mm		50 pc	202345
HRD-C 10x60	10 mm	60 mm	11 mm	14 mm	T40	50 mm		50 pc	423859
HRD-C 10x80	10 mm	80 mm	11 mm	14 mm	T40	50 mm	70 mm	50 pc	423860
HRD-C 10x100	10 mm	100 mm	11 mm	14 mm	T40	50 mm	70 mm	50 pc	423861
HRD-C 10x120	10 mm	120 mm	11 mm	14 mm	T40	50 mm	70 mm	50 pc	423862
HRD-C 10x140	10 mm	140 mm	11 mm	14 mm	T40	50 mm	70 mm	50 pc	423863
HRD-C 10x160	10 mm	160 mm	11 mm	14 mm	T40	50 mm	70 mm	50 pc	423864
HRD-C 10x180	10 mm	180 mm	11 mm	14 mm	T40	50 mm	70 mm	50 pc	423865
HRD-C 10x200	10 mm	200 mm	11 mm	14 mm	T40	50 mm	70 mm	50 pc	423866
HRD-C 10x230	10 mm	230 mm	11 mm	14 mm	T40	50 mm	70 mm	50 pc	423867
HRD-C 10x270	10 mm	270 mm	11 mm	14 mm	T40	50 mm	70 mm	50 pc	423868
HRD-C 10x310	10 mm	310 mm	11 mm	14 mm	T40	50 mm	70 mm	50 pc	423869

## Frame anchor with countersunk head HRD-CR



### Key applications and advantages

- Typical applications for metal fabricators such as fastening handrails, window bars, railings, balustrades, etc.
- Fastening wooden substructures for ventilated facades
- Fastening door and window frames
- Flexible embedment depth (approved at 50 mm and 70 mm embedment depth) - the ideal anchor for a huge range of applications in virtually all base materials
- Suitable for fastening thicknesses up to 260 mm (anchor lengths from 60 mm to 310 mm)

### Technical data

<b>Anchor type</b>	Anchor with screw
<b>Head configuration</b>	Countersunk
<b>Environmental conditions</b>	Outdoor
<b>Type of fastening</b>	Through-fastening
<b>Material composition</b>	Steel, A4 (SS 316) or duplex equivalent, Polyamide
<b>Suitable for cracked concrete with redundant fastenings</b>	Yes
<b>Material, corrosion</b>	Steel, stainless
<b>Installation temperature - min.</b>	-10 °C



Ordering designation	Anchor size	Anchor length	Base plate clearance hole	Screw head diameter	Bit size	Embedment depth 1	Embedment depth 2	Sales pack quantity	Item number
HRD-CR 10x60	10 mm	60 mm	11 mm	14 mm	T40	50 mm		50 pc	423885
HRD-CR 10x100	10 mm	100 mm	11 mm	14 mm	T40	50 mm	70 mm	50 pc	423886
HRD-CR 10x140	10 mm	140 mm	11 mm	14 mm	T40	50 mm	70 mm	50 pc	423887

**Frame anchor with countersunk head HRD-CR2**



**Key applications and advantages**

- Typical applications for metal fabricators such as fastening handrails, window bars, railings, balustrades, etc.
- Fastening wooden substructures for ventilated facades
- Fastening door and window frames
- Flexible embedment depth (approved at 50 mm and 70 mm embedment depth) - the ideal anchor for a huge range of applications in virtually all base materials
- Suitable for fastening thicknesses up to 260 mm (anchor lengths from 60 mm to 310 mm)

**Technical data**

<b>Anchor type</b>	Anchor with screw
<b>Head configuration</b>	Countersunk
<b>Environmental conditions</b>	Outdoor
<b>Type of fastening</b>	Through-fastening
<b>Material composition</b>	Steel, A2 (SS 304) or duplex equivalent, Polyamide
<b>Suitable for cracked concrete with redundant fastenings</b>	Yes
<b>Material, corrosion</b>	Steel, stainless
<b>Installation temperature - min.</b>	-10 °C



Ordering designation	Anchor size	Anchor length	Base plate clearance hole	Screw head diameter	Bit size	Embedment depth 1	Embedment depth 2	Sales pack quantity	Item number
HRD-CR2 10x60	10 mm	60 mm	11 mm	14 mm	T40	50 mm		50 pc	423892
HRD-CR2 10x80	10 mm	80 mm	11 mm	14 mm	T40	50 mm	70 mm	50 pc	423893
HRD-CR2 10x100	10 mm	100 mm	11 mm	14 mm	T40	50 mm	70 mm	50 pc	423894
HRD-CR2 10x120	10 mm	120 mm	11 mm	14 mm	T40	50 mm	70 mm	50 pc	423895
HRD-CR2 10x140	10 mm	140 mm	11 mm	14 mm	T40	50 mm	70 mm	50 pc	423896



### Key applications and advantages

- Fastening metal substructures for ventilated facades
- Typical applications for metal fabricators such as fastening handrails, window bars, railings, balustrades, etc.
- Flexible embedment depth (approved at 50 mm and 70 mm embedment depth) - the ideal anchor for a huge range of applications in virtually all base materials
- Suitable for fastening thicknesses up to 150 mm (anchor lengths from 60 mm to 200 mm)

### Technical data

<b>Anchor type</b>	Anchor with screw
<b>Head configuration</b>	Hex head
<b>Environmental conditions</b>	Indoor, dry conditions
<b>Type of fastening</b>	Through-fastening
<b>Material composition</b>	Steel, zinc-plated (min. 5 µm), Polyamide
<b>Suitable for cracked concrete with redundant fastenings</b>	Yes
<b>Material, corrosion</b>	Steel, zinc-plated
<b>Installation temperature - min.</b>	-10 °C



## Frame anchor with hex head HRD-H



Ordering designation	Anchor size	Anchor length	Base plate clearance hole	Wrench size	Screw head diameter	Bit size	Embedment depth 1	Sales pack quantity	Item number
HRD-H 10x60	10 mm	60 mm	12 mm	13 mm	18 mm	T40	50 mm	50 pc	423870
HRD-H 10x80	10 mm	80 mm	12 mm	13 mm	18 mm	T40	50 mm	50 pc	423871
HRD-H 10x100	10 mm	100 mm	12 mm	13 mm	18 mm	T40	50 mm	50 pc	423872
HRD-H 10x120	10 mm	120 mm	12 mm	13 mm	18 mm	T40	50 mm	50 pc	423873
HRD-H 10x140	10 mm	140 mm	12 mm	13 mm	18 mm	T40	50 mm	50 pc	423874
HRD-H 10x160	10 mm	160 mm	12 mm	13 mm	18 mm	T40	50 mm	50 pc	423875
HRD-H 10x180	10 mm	180 mm	12 mm	13 mm	18 mm	T40	50 mm	50 pc	423876
HRD-H 10x200	10 mm	200 mm	12 mm	13 mm	18 mm	T40	50 mm	50 pc	423877

## Frame anchor with hex head HRD-HF



### Key applications and advantages

- Fastening metal substructures for ventilated facades
- Typical applications for metal fabricators such as fastening handrails, window bars, railings, balustrades, etc.
- Flexible embedment depth (approved at 50 mm and 70 mm embedment depth) - the ideal anchor for a huge range of applications in virtually all base materials
- Suitable for fastening thicknesses up to 150 mm (anchor lengths from 60 mm to 200 mm)

### Technical data

<b>Anchor type</b>	Anchor with screw
<b>Head configuration</b>	Hex head
<b>Environmental conditions</b>	Indoor, damp conditions
<b>Type of fastening</b>	Through-fastening
<b>Material composition</b>	Steel, hot-dip galvanized (min. 65 µm), Polyamide
<b>Suitable for cracked concrete with redundant fastenings</b>	Yes
<b>Material, corrosion</b>	Steel, sherardised / hot-dip galvanised
<b>Installation temperature - min.</b>	-10 °C



Ordering designation	Anchor size	Anchor length	Base plate clearance hole	Wrench size	Screw head diameter	Embedment depth 1	Embedment depth 2	Sales pack quantity	Item number
HRD-HF 10x60	10 mm	60 mm	12 mm	13 mm	18 mm	50 mm		50 pc	423909
HRD-HF 10x80	10 mm	80 mm	12 mm	13 mm	18 mm	50 mm	70 mm	50 pc	423910
HRD-HF 10x100	10 mm	100 mm	12 mm	13 mm	18 mm	50 mm	70 mm	50 pc	423911
HRD-HF 10x120	10 mm	120 mm	12 mm	13 mm	18 mm	50 mm	70 mm	50 pc	423912

### Frame anchor with hex head HRD-HR



#### Key applications and advantages

- Fastening metal substructures for ventilated facades
- Typical applications for metal fabricators such as fastening handrails, window bars, railings, balustrades, etc.
- Flexible embedment depth (approved at 50 mm and 70 mm embedment depth) - the ideal anchor for a huge range of applications in virtually all base materials
- Suitable for fastening thicknesses up to 150 mm (anchor lengths from 60 mm to 200 mm)

#### Technical data

<b>Anchor type</b>	Anchor with screw
<b>Head configuration</b>	Hex head
<b>Environmental conditions</b>	Outdoor
<b>Type of fastening</b>	Through-fastening
<b>Material composition</b>	Steel, A4 (SS 316) or duplex equivalent, Polyamide
<b>Suitable for cracked concrete with redundant fastenings</b>	Yes
<b>Material, corrosion</b>	Steel, stainless
<b>Installation temperature - min.</b>	-10 °C



Ordering designation	Anchor size	Anchor length	Base plate clearance hole	Wrench size	Screw head diameter	Embedment depth 1	Embedment depth 2	Sales pack quantity	Item number
HRD-HR 10x60	10 mm	60 mm	12 mm	13 mm	18 mm	50 mm		50 pc	423888
HRD-HR 10x80	10 mm	80 mm	12 mm	13 mm	18 mm	50 mm	70 mm	50 pc	423889
HRD-HR 10x100	10 mm	100 mm	12 mm	13 mm	18 mm	50 mm	70 mm	50 pc	423890
HRD-HR 10x140	10 mm	140 mm	12 mm	13 mm	18 mm	50 mm	70 mm	50 pc	423891

### Frame anchor with hex head HRD-HR2



#### Key applications and advantages

- Fastening metal substructures for ventilated facades
- Typical applications for metal fabricators such as fastening handrails, window bars, railings, balustrades, etc.
- Flexible embedment depth (approved at 50 mm and 70 mm embedment depth) - the ideal anchor for a huge range of applications in virtually all base materials
- Suitable for fastening thicknesses up to 150 mm (anchor lengths from 60 mm to 200 mm)

#### Technical data

<b>Anchor type</b>	Anchor with screw
<b>Head configuration</b>	Hex head
<b>Environmental conditions</b>	Outdoor
<b>Type of fastening</b>	Through-fastening
<b>Material composition</b>	Steel, A2 (SS 304) or duplex equivalent, Polyamide
<b>Suitable for cracked concrete with redundant fastenings</b>	Yes
<b>Material, corrosion</b>	Steel, stainless
<b>Installation temperature - min.</b>	-10 °C



Ordering designation	Anchor size	Anchor length	Base plate clearance hole	Wrench size	Screw head diameter	Embedment depth 1	Embedment depth 2	Sales pack quantity	Item number
HRD-HR2 10x60	10 mm	60 mm	12 mm	13 mm	18 mm	50 mm		50 pc	423897
HRD-HR2 10x80	10 mm	80 mm	12 mm	13 mm	18 mm	50 mm	70 mm	50 pc	423898
HRD-HR2 10x100	10 mm	100 mm	12 mm	13 mm	18 mm	50 mm	70 mm	50 pc	423899
HRD-HR2 10x120	10 mm	120 mm	12 mm	13 mm	18 mm	50 mm	70 mm	50 pc	423900
HRD-HR2 10x140	10 mm	140 mm	12 mm	13 mm	18 mm	50 mm	70 mm	50 pc	423901



## Frame anchor with hex head HRD-K



### Key applications and advantages

- Fastening metal substructures for ventilated facades
- Typical applications for metal fabricators such as fastening handrails, window bars, railings, balustrades, etc.
- Flexible embedment depth (approved at 50 mm and 70 mm embedment depth) - the ideal anchor for a huge range of applications in virtually all base materials
- Suitable for fastening thicknesses up to 90 mm (anchor lengths from 60 mm to 140 mm)

### Technical data

<b>Anchor type</b>	Anchor with screw
<b>Head configuration</b>	Hex head
<b>Environmental conditions</b>	Indoor, dry conditions
<b>Type of fastening</b>	Through-fastening
<b>Material composition</b>	Steel, zinc-plated (min. 5 µm), Polyamide
<b>Suitable for cracked concrete with redundant fastenings</b>	Yes
<b>Material, corrosion</b>	Steel, zinc-plated
<b>Installation temperature - min.</b>	-10 °C



Ordering designation	Anchor size	Anchor length	Base plate clearance hole	Wrench size	Screw head diameter	Bit size	Embedment depth 1	Sales pack quantity	Item number
HRD-K 10x60	10 mm	60 mm	12 mm	13 mm	18 mm	T40	50 mm	50 pc	423878
HRD-K 10x80	10 mm	80 mm	12 mm	13 mm	18 mm	T40	50 mm	50 pc	423879
HRD-K 10x100	10 mm	100 mm	12 mm	13 mm	18 mm	T40	50 mm	50 pc	423880
HRD-K 10x120	10 mm	120 mm	12 mm	13 mm	18 mm	T40	50 mm	50 pc	423881
HRD-K 10x140	10 mm	140 mm	12 mm	13 mm	18 mm	T40	50 mm	50 pc	423882

## Frame anchor with hex head HRD-KR2



### Key applications and advantages

- Fastening metal substructures for ventilated facades
- Typical applications for metal fabricators such as fastening handrails, window bars, railings, balustrades, etc.
- Flexible embedment depth (approved at 50 mm and 70 mm embedment depth) - the ideal anchor for a huge range of applications in virtually all base materials
- Suitable for fastening thicknesses up to 90 mm (anchor lengths from 60 mm to 140 mm)

### Technical data

<b>Anchor type</b>	Anchor with screw
<b>Head configuration</b>	Hex head
<b>Environmental conditions</b>	Outdoor
<b>Type of fastening</b>	Through-fastening
<b>Material composition</b>	Steel, A2 (SS 304) or duplex equivalent, Polyamide
<b>Suitable for cracked concrete with redundant fastenings</b>	Yes
<b>Material, corrosion</b>	Steel, stainless
<b>Installation temperature - min.</b>	-10 °C



Ordering designation	Anchor size	Anchor length	Base plate clearance hole	Wrench size	Screw head diameter	Embedment depth 1	Embedment depth 2	Sales pack quantity	Item number
HRD-KR2 10x60	10 mm	60 mm	12 mm	13 mm	18 mm	50 mm		50 pc	423902
HRD-KR2 10x80	10 mm	80 mm	12 mm	13 mm	18 mm	50 mm	70 mm	50 pc	423903
HRD-KR2 10x100	10 mm	100 mm	12 mm	13 mm	18 mm	50 mm	70 mm	50 pc	423904
HRD-KR2 10x120	10 mm	120 mm	12 mm	13 mm	18 mm	50 mm	70 mm	50 pc	423905
HRD-KR2 10x140	10 mm	140 mm	12 mm	13 mm	18 mm	50 mm	70 mm	50 pc	423906

### Frame anchor with pan head HRD-P



#### Key applications and advantages

- Typical applications for metal fabricators such as fastening handrails, window bars, railings, balustrades, etc.
- Flexible embedment depth (approved at 50 mm and 70 mm embedment depth) - the ideal anchor for a huge range of applications in virtually all base materials
- Available in 2 different materials for optimum suitability in all corrosive environments

#### Technical data

<b>Anchor type</b>	Anchor with screw
<b>Head configuration</b>	Round head
<b>Environmental conditions</b>	Indoor, dry conditions
<b>Type of fastening</b>	Through-fastening
<b>Material composition</b>	Steel, zinc-plated (min. 5 µm), Polyamide
<b>Suitable for cracked concrete with redundant fastenings</b>	Yes
<b>Material, corrosion</b>	Steel, zinc-plated
<b>Installation temperature - min.</b>	-10 °C



Ordering designation	Anchor size	Anchor length	Base plate clearance hole	Bit size	Embedment depth 1	Embedment depth 2	Fastening thickness at embed.1	Sales pack quantity	Item number
HRD-P 10x60	10 mm	60 mm	12 mm	T40	50 mm		10 mm	50 pc	423883
HRD-P 10x80	10 mm	80 mm	12 mm	T40	50 mm	70 mm	30 mm	50 pc	423884

### Frame anchor with pan head HRD-PR2



#### Key applications and advantages

- Typical applications for metal fabricators such as fastening handrails, window bars, railings, balustrades, etc.
- Flexible embedment depth (approved at 50 mm and 70 mm embedment depth) - the ideal anchor for a huge range of applications in virtually all base materials
- Available in 2 different materials for optimum suitability in all corrosive environments

#### Technical data

<b>Anchor type</b>	Anchor with screw
<b>Head configuration</b>	Round head
<b>Environmental conditions</b>	Outdoor
<b>Type of fastening</b>	Through-fastening
<b>Material composition</b>	Steel, A2 (SS 304) or duplex equivalent, Polyamide
<b>Suitable for cracked concrete with redundant fastenings</b>	Yes
<b>Material, corrosion</b>	Steel, stainless
<b>Installation temperature - min.</b>	-10 °C



Ordering designation	Anchor size	Anchor length	Base plate clearance hole	Bit size	Embedment depth 1	Embedment depth 2	Fastening thickness at embed.1	Sales pack quantity	Item number
HRD-PR2 10x60	10 mm	60 mm	12 mm	T40	50 mm		10 mm	50 pc	423907
HRD-PR2 10x80	10 mm	80 mm	12 mm	T40	50 mm	70 mm	30 mm	50 pc	423908



### Key applications and advantages

- Fastening trim strips, battens and components for electrical and plumbing installations
- Fastening components for electrical and plumbing installations
- For universal use on many materials, including perforated brick and block
- The hammer-driven screw can also be driven or unscrewed using a screwdriver

### Technical data

<b>Anchor type</b>	Plastic anchor
<b>Head configuration</b>	Countersunk Phillips
<b>Environmental conditions</b>	Indoor, dry conditions
<b>Type of fastening</b>	Through-fastening
<b>Material composition</b>	Body: polyamide, Screw: steel, zinc-plated (min. 5 µm)
<b>Installation direction</b>	All
<b>Material, corrosion</b>	Steel, zinc-plated
<b>In-service temperature – range</b>	-40 - 80 °C

## Impact anchor HPS-1



Ordering designation	Anchor size	Bit size	Packaging	Standard embedment depth	Max. fixture thickness at standard embedment depth	Drilling depth	Sales pack quantity	Item number
HPS-1 4/0x20	M4	PZ2	Box	20 mm	2 mm	25 mm	250 pc	260369
HPS-1 5/10x30	M5	PZ2	Box	20 mm	10 mm	30 mm	200 pc	230515
HPS-1 5/5x25	M5	PZ2	Box	20 mm	5 mm	30 mm	200 pc	260347
HPS-1 5/15x35	M5	PZ2	Box	20 mm	15 mm	30 mm	200 pc	260348
HPS-1 5/0x20	M5	PZ2	Box	20 mm	2 mm	25 mm	250 pc	260395
HPS-1 6/30x55	M6	PZ2	Box	25 mm	30 mm	40 mm	100 pc	230517
HPS-1 6/25x50	M6	PZ2	Box	25 mm	25 mm	40 mm	100 pc	260351
HPS-1 6/40x65	M6	PZ2	Box	25 mm	40 mm	40 mm	100 pc	260352
HPS-1 6/10x35	M6	PZ2	Box	25 mm	10 mm	40 mm	150 pc	230516
HPS-1 6/5x30	M6	PZ2	Box	25 mm	5 mm	40 mm	150 pc	260349
HPS-1 6/15x40	M6	PZ2	Box	25 mm	15 mm	40 mm	150 pc	260350
HPS-1 6/5x30 (1800)	M6	PZ2	Bucket	25 mm	5 mm	40 mm	1800 pc	253530
HPS-1 8/20x50	M8	PZ2	Box	30 mm	20 mm	50 mm	50 pc	230518
HPS-1 8/40x70	M8	PZ2	Box	30 mm	40 mm	50 mm	50 pc	230519
HPS-1 8/30x60	M8	PZ2	Box	30 mm	30 mm	50 mm	50 pc	260354
HPS-1 8/60x90	M8	PZ2	Box	30 mm	60 mm	50 mm	50 pc	260355
HPS-1 8/80x110	M8	PZ2	Box	30 mm	80 mm	50 mm	50 pc	260356
HPS-1 8/0x25	M8	PZ2	Box	30 mm	2 mm	50 mm	100 pc	238160
HPS-1 8/10x40	M8	PZ2	Box	30 mm	10 mm	50 mm	100 pc	260353
HPS-1 8/100x130	M8	PZ2	Box	30 mm	100 mm	50 mm	100 pc	260367

## Impact anchor HPS-1 R



### Key applications and advantages

- Anchoring light frames, battens and profiles in hollow and solid base materials
- Corrosion-resistant for outdoor use
- Fastening components for electrical and plumbing installations
- Stainless steel hammer-driven screw for outdoor use
- Quick impact installation using a hammer

### Technical data

<b>Anchor type</b>	Plastic anchor
<b>Head configuration</b>	Countersunk Phillips
<b>Environmental conditions</b>	Outdoor
<b>Type of fastening</b>	Through-fastening
<b>Material composition</b>	Body: polyamide, Screw: 304 stainless steel
<b>Installation direction</b>	All
<b>Material, corrosion</b>	Steel, stainless
<b>In-service temperature – range</b>	-40 - 80 °C

Ordering designation	Anchor size	Anchor length	Bit size	Standard embedment depth	Max. fixture thickness at standard embedment depth	Drilling depth	Sales pack quantity	Item number
HPS-1 R 5/5x25	M5	27 mm	PZ2	20 mm	5 mm	30 mm	200 pc	260357
HPS-1 R 5/15x35	M5	37 mm	PZ2	20 mm	15 mm	30 mm	200 pc	260358
HPS-1 R 6/0x25	M6	27 mm	PZ2	25 mm	2 mm	40 mm	150 pc	238161
HPS-1 R 6/5x30	M6	32 mm	PZ2	25 mm	5 mm	40 mm	150 pc	260359
HPS-1 R 6/15x40	M6	42 mm	PZ2	25 mm	15 mm	40 mm	100 pc	260360
HPS-1 R 6/25x50	M6	52 mm	PZ2	25 mm	25 mm	40 mm	100 pc	260361

Ordering designation	Anchor size	Anchor length	Bit size	Standard embedment depth	Max. fixture thickness at standard embedment depth	Drilling depth	Sales pack quantity	Item number
<b>HPS-1 R 6/40x65</b>	M6	67 mm	PZ2	25 mm	40 mm	40 mm	100 pc	<b>260362</b>
<b>HPS-1 R 8/10x40</b>	M8	43 mm	PZ2	30 mm	10 mm	50 mm	100 pc	<b>260363</b>
<b>HPS-1 R 8/30x60</b>	M8	63 mm	PZ2	30 mm	30 mm	50 mm	50 pc	<b>260364</b>
<b>HPS-1 R 8/40x70</b>	M8	73 mm	PZ2	30 mm	40 mm	50 mm	50 pc	<b>230528</b>
<b>HPS-1 R 8/60x90</b>	M8	93 mm	PZ2	30 mm	60 mm	50 mm	50 pc	<b>260365</b>
<b>HPS-1 R 8/80x110</b>	M8	113 mm	PZ2	30 mm	80 mm	50 mm	50 pc	<b>260366</b>

## Universal plastic anchor HUD-1



### Key applications and advantages

- Many kinds of light-duty fastenings, especially electrical installations, sanitary fixtures, etc.
- For use on a wide range of materials: concrete, solid brick, hollow brick, gas (aerated) concrete, gypsum panel
- High holding power

Technical data	
<b>Anchor type</b>	Plastic anchor
<b>Head configuration</b>	n/a
<b>Environmental conditions</b>	Indoor, damp conditions, Indoor, dry conditions, Outdoor
<b>Type of fastening</b>	Pre-fastening, Through-fastening
<b>Material composition</b>	Polyamide PA 6
<b>Installation direction</b>	All



Ordering designation	Anchor size	Anchor length	Base plate clearance hole	Packaging	Standard embedment depth	Drilling depth	Sales pack quantity	Item number
HUD-1 5x25	5 mm	25 mm	5 mm	Bag	25 mm	35 mm	500 pc	331615
HUD-1 6x30	6 mm	30 mm	6 mm	Bag	30 mm	40 mm	200 pc	338709
HUD-1 6x30	6 mm	30 mm	6 mm	Bag	30 mm	40 mm	500 pc	331616
HUD-1 8x40	8 mm	40 mm	8 mm	Bag	40 mm	55 mm	200 pc	338710
HUD-1 8x40	8 mm	40 mm	8 mm	Bag	40 mm	55 mm	400 pc	331617
HUD-1 10x50	10 mm	50 mm	10 mm	Bag	50 mm	65 mm	100 pc	338711
HUD-1 10x50	10 mm	50 mm	10 mm	Bag	50 mm	65 mm	200 pc	331618
HUD-1 12x60	12 mm	60 mm	13 mm	Bag	60 mm	80 mm	100 pc	331619

## Universal plastic anchor HUD-L



### Key applications and advantages

- Refurbishing work on thick layers of plaster and on double-clad drywall panels, e.g. battens, junction boxes, cables, light switches, lights, brackets, signs, shelves, plumbing fixtures, wall brackets etc.
- Extra-long plastic anchor for refurbishment and renovation work or drywall installation
- Extra long, for bridging thick layers of plaster up to 30 mm
- Forms a "knot" when set in hollow materials and double-clad drywall panels

### Technical data

<b>Anchor type</b>	Plastic anchor
<b>Head configuration</b>	n/a
<b>Environmental conditions</b>	Indoor, damp conditions, Indoor, dry conditions, Outdoor
<b>Type of fastening</b>	Pre-fastening, Through-fastening
<b>Material composition</b>	Body: polyamide
<b>Installation direction</b>	All
<b>LEED information available</b>	Yes
<b>Material, corrosion</b>	Plastic
<b>In-service temperature – range</b>	-40 - 80 °C
<b>Installation tools</b>	SFC 14-A



Ordering designation	Anchor diameter (imperial)	Anchor size	Anchor length	Base plate clearance hole	Packaging	Standard embedment depth	Drilling depth	Sales pack quantity	Item number
HUD-L 6x50	1/4 in	6 mm	47 mm	6 mm	Box	47 mm	70 mm	400 pc	315938
HUD-L 8x60	5/16 in	8 mm	57 mm	8 mm	Box	57 mm	80 mm	200 pc	315939
HUD-L 10x70	3/8 in	10 mm	70 mm	10 mm	Box	70 mm	90 mm	100 pc	315940



**Key applications and advantages**

- Many kinds of light-duty fastenings on gas concrete
- Higher loads through well-balanced distribution of forces in the base material
- Reliable setting

Technical data	
<b>Anchor type</b>	Plastic anchor
<b>Head configuration</b>	Countersunk, Round head, Hex head, Flat head
<b>Environmental conditions</b>	Highly corrosive special applications, Indoor, damp conditions, Indoor, dry conditions, Outdoor
<b>Type of fastening</b>	Pre-fastening, Through-fastening
<b>Material composition</b>	Polyamide PA 6
<b>Installation direction</b>	All
<b>Material, corrosion</b>	Plastic

**Gas concrete anchor HGN**



Ordering designation	Anchor size	Anchor length	Standard embedment depth	Drilling depth	Sales pack quantity	Item number
HGN 12	12 mm	75 mm	75 mm	95 mm	50 pc	45626
HGN 14	14 mm	85 mm	85 mm	110 mm	50 pc	45627

**Light-duty anchor HLD**



**Key applications and advantages**

- Fastening on low-strength materials with cavities - for use with standard wood screws
- Anchoring in perforated brick or block, drywall, concrete
- The wings spring out and adapt to all materials
- Allows flexibility when selecting screws

Technical data	
<b>Anchor type</b>	Plastic anchor
<b>Head configuration</b>	Flat head, Round head
<b>Environmental conditions</b>	Indoor, damp conditions, Indoor, dry conditions, Outdoor
<b>Type of fastening</b>	Pre-fastening, Through-fastening
<b>Material composition</b>	Polyamide PA 6
<b>Installation direction</b>	Wall



Ordering designation	Anchor diameter (imperial)	Anchor size	Anchor length	Packaging	Max. fixture thickness at standard embedment depth	Drilling depth	Sales pack quantity	Item number
HLD 2	3/8 in	10 mm	28 mm	Box	33 mm	50 mm	150 pc	335506
HLD 3	3/8 in	10 mm	35 mm	Box	40 mm	56 mm	100 pc	335507
HLD 4	3/8 in	10 mm	44 mm	Box	49 mm	66 mm	100 pc	335508



### Key applications and advantages

- Insulation fastenings with fire resistance requirements
- Certified fire resistance
- Fire resistant fastener for insulation materials up to 150 mm



### Technical data

<b>Anchor type</b>	Insulation holder
<b>Environmental conditions</b>	Indoor, ventilated facades
<b>Type of fastening</b>	Through-fastening
<b>Material composition</b>	Steel, zinc-plated (min. 5 µm)
<b>Installation direction</b>	All
<b>Material, corrosion</b>	Steel, zinc-plated
<b>ETICS</b>	No

## Metal insulation fastener IDMS



Ordering designation	Anchor length	Insulation material thickness fastened - min.	Insulation material thickness fastened - max.	Standard embedment depth	Sales pack quantity	Item number
IDMS 0/ 3	80 mm	0 mm	30 mm	50 mm	250 pc	65752
IDMS 3/ 6	110 mm	30 mm	60 mm	50 mm	250 pc	65753
IDMS 6/ 9	140 mm	60 mm	90 mm	50 mm	250 pc	65754
IDMS 9/12	170 mm	90 mm	120 mm	50 mm	150 pc	65725
IDMS 12/15	200 mm	120 mm	150 mm	50 mm	150 pc	45358

## Stainless steel insulation fastener IDMR



### Key applications and advantages

- Insulation fastenings with corrosion and fire resistance requirements
- Fire resistant fastener in A2 steel for insulation materials up to 150 mm
- Set simply by hammering in

### Technical data

<b>Anchor type</b>	Insulation holder
<b>Environmental conditions</b>	Outdoor
<b>Type of fastening</b>	Through-fastening
<b>Material composition</b>	Steel, A2 (SS 304)
<b>Installation direction</b>	All
<b>Material, corrosion</b>	Steel, stainless
<b>ETICS</b>	No

Ordering designation	Anchor length	Insulation material thickness fastened - min.	Insulation material thickness fastened - max.	Standard embedment depth	Sales pack quantity	Item number
IDMR 3/ 6	110 mm	30 mm	60 mm	50 mm	250 pc	65787

## Insulation fastener and plug IZ, IZ-P



Ordering designation	Anchor length	Colour	Insulation material thickness fastened - min.	Insulation material thickness fastened - max.	Standard embedment depth	Sales pack quantity	Item number
IZ 8x70	70 mm	White	10 mm	20 mm	40 mm	250 pc	378160
IZ 8x90 black	90 mm	Black	20 mm	40 mm	40 mm	250 pc	285450
IZ 8x90	90 mm	White	20 mm	40 mm	40 mm	250 pc	378161
IZ 8x110	110 mm	White	40 mm	60 mm	40 mm	200 pc	378162
IZ 8x130	130 mm	White	60 mm	80 mm	40 mm	200 pc	378163
IZ 8x150	150 mm	White	80 mm	120 mm	40 mm	150 pc	378164
IZ 8x190	190 mm	White	140 mm	160 mm	40 mm	100 pc	378166

Ordering designation	Anchor length	Colour	Insulation material thickness fastened - min.	Insulation material thickness fastened - max.	Standard embedment depth	Sales pack quantity	Item number
IZ 8x210 black	210 mm	Black	160 mm	180 mm	40 mm	100 pc	285456
IZ 8x210	210 mm	White	160 mm	180 mm	40 mm	100 pc	378167
IZ 8x250 (50)	250 mm	Black	200 mm	220 mm	40 mm	50 pc	2022695

**Insulation anchor IDP**



**Key applications and advantages**

- Fastening rigid, self-supporting, insulating materials such as expanded polystyrene
- Quick and easy impact installation
- Insulating material thickness: up to 150 mm

**Technical data**

<b>Anchor type</b>	Insulation holder
<b>Type of fastening</b>	Through-fastening
<b>Material composition</b>	Polypropylene
<b>Installation direction</b>	All
<b>Material, corrosion</b>	Plastic
<b>Installation temperature - max.</b>	40 °C
<b>Installation temperature - min.</b>	0 °C
<b>ETICS</b>	No

Ordering designation	Colour	Min. embedment depth	Insulation material thickness fastened - min.	Insulation material thickness fastened - max.	Standard embedment depth	Sales pack quantity	Item number
IDP 0/2	White	28 mm	0 mm	20 mm	25 mm	250 pc	332105
IDP 2/4	White	28 mm	20 mm	40 mm	25 mm	250 pc	332106
IDP 4/6	White	28 mm	40 mm	60 mm	25 mm	250 pc	332107
IDP 6/8	White	28 mm	60 mm	80 mm	25 mm	250 pc	332108
IDP 8/10	White	28 mm	80 mm	100 mm	25 mm	250 pc	332109
IDP 10/12	White	28 mm	100 mm	120 mm	25 mm	250 pc	332110
IDP 13/15	White	28 mm	120 mm	150 mm	25 mm	250 pc	332111

**Hilti insulation fastener HIF**



Ordering designation	Anchor length	Colour	Min. embedment depth	Insulation material thickness fastened - min.	Insulation material thickness fastened - max.	Standard embedment depth	Max. fixture thickness at standard embedment depth	Sales pack quantity	Item number
HIF 60	85 mm	Black	20 mm	40 mm	60 mm	20 mm	60 mm	250 pc	2061576
HIF 80	105 mm	Black	20 mm	60 mm	80 mm	20 mm	80 mm	250 pc	2061577
HIF 100	125 mm	Black	20 mm	80 mm	100 mm	20 mm	100 mm	200 pc	2061578
HIF 120	145 mm	Black	20 mm	100 mm	120 mm	20 mm	120 mm	200 pc	2061579
HIF 140	165 mm	Black	20 mm	120 mm	140 mm	20 mm	140 mm	150 pc	2061610
HIF 160	185 mm	Black	20 mm	140 mm	160 mm	20 mm	160 mm	150 pc	2061611
HIF 180	205 mm	Black	20 mm	160 mm	180 mm	20 mm	180 mm	100 pc	2061612
HIF 200	225 mm	Black	20 mm	180 mm	200 mm	20 mm	200 mm	100 pc	2061613
HIF 220	245 mm	Black	20 mm	200 mm	220 mm	20 mm	220 mm	100 pc	2061614
HIF 240	265 mm	Black	20 mm	220 mm	240 mm	20 mm	240 mm	100 pc	2061615



# INNOVATION IN V-FORM.

With over 60 years of experience in fastening systems, Hilti is your reliable partner for secure anchor solutions. We have now further extended our range of products to include a new generation of cast-in anchor channels for reliable load transfer to concrete structures – the Hilti HAC anchor channel.



## Designed for static and dynamic loads as well as loads occurring in the event of fire.

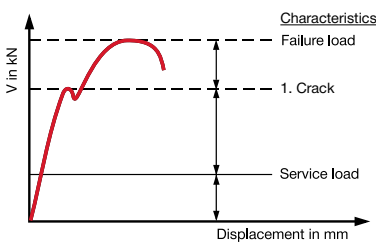

### Designed for static loads.

Only very low displacement occurs under service loads with Hilti anchor channels in cracked concrete. The anchor channels exhibit ductile behavior when the ultimate limit state is exceeded and provide clear advance warning before failure occurs

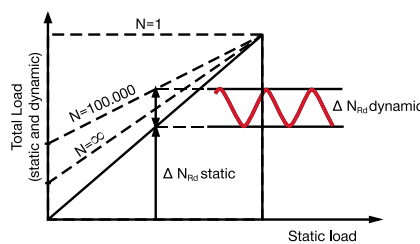

### Designed for dynamic loads.

The new design method employed allows dynamic loads to be taken into account in terms of short-term as well as long-term fatigue strength for tensile loads acting in conjunction with static loads. The basis for this is formed by the Wöhler fatigue strength curves determined experimentally for the entire oscillation spectrum.

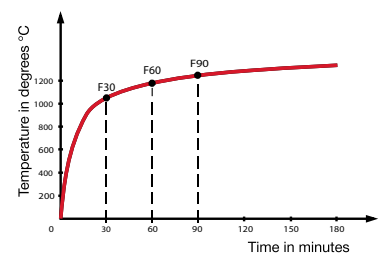

### Designed for loads occurring on exposure to fire.

An all-encompassing design concept for anchor channels was developed for the first time. This concept takes the loads that occur during exposure to fire into account in accordance with the standard temperature curve (ETK and ISO 834, DIN 4102 T.2) for pure tensile as well as shear loading. Design calculations are made according to EOTA TR020 or, respectively, CEN/TS 1992-4.



## New design software.

Hilti PROFIS Anchor Channel for cast-in anchor channels and hammerhead bolts.

The specification of anchor channels in accordance with CEN demands use of flexible, up-to-date software that lets engineers work efficiently. PROFIS Anchor Channel, the new PC application from Hilti, meets these requirements admirably.

- Fast, flexible and user-friendly – based on the proven PROFIS application platform.
- Detailed, easy-to-follow calculation approach shown on the screen and on printed copies.
- Database link to DWX/DWG files in 2D and 3D for integration in CAD drawings.

## New design method.

For anchor channels, based on CEN/TS 1992-4-3.

Already several years ago, the design of anchor fastenings in concrete with partial safety factors in accordance with European guidelines led to better utilization of each fastening point. This is now also possible with the design of cast-in anchor channels. Both of these fastening methods have thus been adapted to the European standards applicable in the field of construction.

- Design of fastening points for static and dynamic loads as well as loads occurring in the event of fire is according to the state of the art.

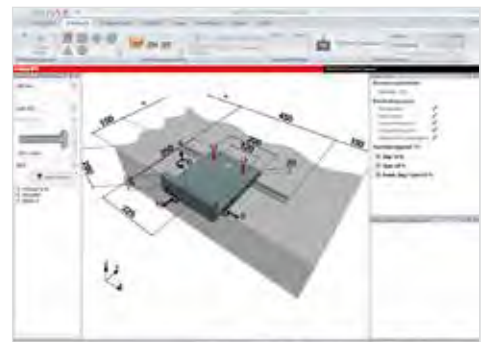

- Individual design of anchor channels and T-head bolts
- Loads can be entered directly on the baseplate
- Instant display of calculation results upon changing parameters
- Optimisation options

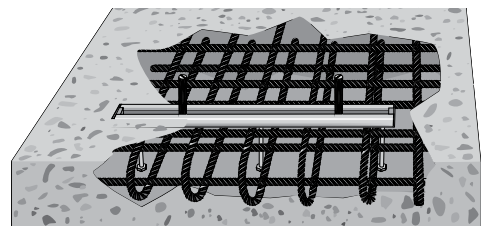

Takes specific conditions into account, such as

- Concrete member thickness
- Concrete grade
- Supplementary reinforcement
- Edge distances
- Type of load / direction of application

## Anchor channel HAC-20



### Key applications and advantages

- Brick wall ties
- Connection of brick walls to concrete structures using wall-ties
- Connection of pre-cast components using connectors
- Simplification of the range available  
Versatile channel geometry allowing usage of same bolt type in HAC-10 and HAC-20 channels
- Fast and convenient removal of LDPE foam filling

### Technical data

<b>Anchor type</b>	Anchor channel
<b>Environmental conditions</b>	Indoor, damp conditions
<b>Type of fastening</b>	Pre-fastening
<b>Material composition</b>	Steel, hot-dip galvanized
<b>Width</b>	28 mm
<b>Height</b>	18 mm
<b>Material, corrosion</b>	Steel, sherardised / hot-dip galvanized



Ordering designation	Length	Number of anchors	Anchor distance	Standard embedment depth	Sales pack quantity	Item number
HAC-20 76/150 F	150 mm	2	100 mm	76 mm	1 pc	431880
HAC-20 76/200 F	200 mm	2	150 mm	76 mm	1 pc	431881
HAC-20 76/250 F	250 mm	2	200 mm	76 mm	1 pc	431882
HAC-20 76/350 F	350 mm	3	150 mm	76 mm	1 pc	431883
HAC-20 76/450 F	450 mm	3	200 mm	76 mm	1 pc	431884
HAC-20 76/1050 F	1050 mm	6	200 mm	76 mm	1 pc	431885
HAC-20 76/2250 F	2250 mm	12	200 mm	76 mm	1 pc	431886
HAC-20 76/3050 F	3050 mm	16	200 mm	76 mm	1 pc	431887
HAC-20 76/5850 F	5850 mm	30	200 mm	76 mm	1 pc	431888

## Anchor channel HAC-30



### Key applications and advantages

- Installation of building services in the basement backbone, risers and backbones for each level
- Floor or ceiling grid systems for applications with demanding requirements in terms of flexibility and dust or noise reduction e.g. semiconductor manufacturing or showrooms
- Main runs of pipes or ducts for heating, plumbing, ventilation and air conditioning
- Serrated channel is compatible with Hilti MQ41 installation components
- Faster installation of building services than with traditional anchor fastening methods

### Technical data

<b>Anchor type</b>	Anchor channel
<b>Environmental conditions</b>	Indoor, damp conditions
<b>Type of fastening</b>	Pre-fastening
<b>Material composition</b>	Steel, hot-dip galvanized (min. 50 µm)
<b>Tooth configuration</b>	Toothed
<b>Width</b>	41 mm
<b>Height</b>	26 mm
<b>Material, corrosion</b>	Steel, sherardised / hot-dip galvanized



Ordering designation	Length	Number of anchors	Anchor distance	Standard embedment depth	Sales pack quantity	Item number
HAC-30 68/250 F	250 mm	2	200 mm	68 mm	1 pc	431890
HAC-30 68/300 F	300 mm	2	250 mm	68 mm	1 pc	431891
HAC-30 68/550 F	550 mm	3	250 mm	68 mm	1 pc	431892
HAC-30 68/800 F	800 mm	4	250 mm	68 mm	1 pc	431893
HAC-30 68/1050 F	1050 mm	5	250 mm	68 mm	1 pc	431894
HAC-30 68/2300 F	2300 mm	10	250 mm	68 mm	1 pc	431897
HAC-30 68/3050 F	3050 mm	13	250 mm	68 mm	1 pc	431898
HAC-30 68/5800 F	5800 mm	24	250 mm	68 mm	1 pc	431900

## Anchor channel HAC-40

### Key applications and advantages

- Fastening curtain wall brackets
- Fastening guide rails for elevators and counterweights
- Fastening sliding door mechanisms for elevators
- Innovative V-shape provides high load resistance and close edge distances
- New type of protective, environmentally friendly foam insert (LDPE) and end caps seal the channel effectively, preventing concrete slurry from entering the channel

### Technical data

<b>Anchor type</b>	Anchor channel
<b>Environmental conditions</b>	Indoor, damp conditions
<b>Type of fastening</b>	Pre-fastening
<b>Material composition</b>	Steel, hot-dip galvanized (min. 55 µm)
<b>Width</b>	41 mm
<b>Height</b>	28 mm
<b>Material, corrosion</b>	Steel, sherardised / hot-dip galvanized



Ordering designation	Length	Number of anchors	Anchor distance	Standard embedment depth	Sales pack quantity	Item number
HAC-40 91/150 F	150 mm	2	100 mm	91 mm	1 pc	2019810
HAC-40 91/200 F	200 mm	2	150 mm	91 mm	1 pc	431906
HAC-40 91/250 F	250 mm	2	200 mm	91 mm	1 pc	431907
HAC-40 91/300 F	300 mm	2	250 mm	91 mm	1 pc	431908
HAC-40 91/350 F	350 mm	3	150 mm	91 mm	1 pc	431909
HAC-40 91/450 F	450 mm	3	200 mm	91 mm	1 pc	431910
HAC-40 91/550 F	550 mm	3	250 mm	91 mm	1 pc	431911
HAC-40 91/800 F	800 mm	4	250 mm	91 mm	1 pc	431912
HAC-40 91/1050 F	1050 mm	5	250 mm	91 mm	1 pc	431913
HAC-40 91/1300 F	1300 mm	6	250 mm	91 mm	1 pc	431914
HAC-40 91/1550 F	1550 mm	7	250 mm	91 mm	1 pc	431905
HAC-40 91/2050 F	2050 mm	9	250 mm	91 mm	1 pc	2014824
HAC-40 91/2300 F	2300 mm	10	250 mm	91 mm	1 pc	431915
HAC-40 91/5800 F	5800 mm	24	250 mm	91 mm	1 pc	431916

## Anchor channel HAC-50



### Key applications and advantages

- Fastening curtain wall brackets
- For the installation of guide rails and doors in elevator installation
- Fastening guide rails for elevators and counterweights
- Innovative V-shape provides high load resistance and close edge distances
- Only one HBC-C bolt type required for HAC-40 to HAC-70 channels

### Technical data

<b>Anchor type</b>	Anchor channel
<b>Environmental conditions</b>	Indoor, damp conditions
<b>Type of fastening</b>	Pre-fastening
<b>Material composition</b>	Steel, hot-dip galvanized (min. 55 µm)
<b>Width</b>	42 mm
<b>Height</b>	31 mm
<b>Material, corrosion</b>	Steel, sherardised / hot-dip galvanized

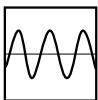

Ordering designation	Length	Number of anchors	Anchor distance	Standard embedment depth	Sales pack quantity	Item number
HAC-50 106/150 F	150 mm	2	100 mm	106 mm	1 pc	2019811
HAC-50 106/200 F	200 mm	2	150 mm	106 mm	1 pc	431835
HAC-50 106/250 F	250 mm	2	200 mm	106 mm	1 pc	431836
HAC-50 106/300 F	300 mm	2	250 mm	106 mm	1 pc	431837
HAC-50 106/350 F	350 mm	3	150 mm	106 mm	1 pc	431838
HAC-50 106/450 F	450 mm	3	200 mm	106 mm	1 pc	431839
HAC-50 106/550 F	550 mm	3	250 mm	106 mm	1 pc	431840
HAC-50 106/800 F	800 mm	4	250 mm	106 mm	1 pc	431841
HAC-50 106/1050 F	1050 mm	5	250 mm	106 mm	1 pc	431842
HAC-50 106/1300 F	1300 mm	6	250 mm	106 mm	1 pc	431843
HAC-50 106/1550 F	1550 mm	7	250 mm	106 mm	1 pc	431846
HAC-50 106/2300 F	2300 mm	10	250 mm	106 mm	1 pc	431844
HAC-50 106/5800 F	5800 mm	24	250 mm	106 mm	1 pc	431845

## Anchor channel HAC-60

### Key applications and advantages

- Fastening curtain wall brackets
- For the installation of guide rails and doors in elevator installation
- Fastening guide rails for elevators and counterweights
- Innovative V-shape provides high load resistance and close edge distances
- Only one HBC-C bolt type required for HAC-40 to HAC-70 channels

### Technical data

<b>Anchor type</b>	Anchor channel
<b>Environmental conditions</b>	Indoor, damp conditions
<b>Type of fastening</b>	Pre-fastening
<b>Material composition</b>	Steel, hot-dip galvanized (min. 70 µm)
<b>Width</b>	43 mm
<b>Height</b>	36 mm
<b>Material, corrosion</b>	Steel, sherardised / hot-dip galvanized



Ordering designation	Length	Number of anchors	Anchor distance	Standard embedment depth	Sales pack quantity	Item number
HAC-60 148/300 F	300 mm	2	250 mm	148 mm	1 pc	431850
HAC-60 148/350 F	350 mm	3	150 mm	148 mm	1 pc	431851
HAC-60 148/450 F	450 mm	3	200 mm	148 mm	1 pc	431852
HAC-60 148/550 F	550 mm	3	250 mm	148 mm	1 pc	431853
HAC-60 148/1050 F	1050 mm	5	250 mm	148 mm	1 pc	431854
HAC-60 148/2300 F	2300 mm	10	250 mm	148 mm	1 pc	431855
HAC-60 148/5800 F	5800 mm	24	250 mm	148 mm	1 pc	431856

## Anchor channel HAC-70

### Key applications and advantages

- Fastening curtain wall brackets
- Fastening guide rails for elevators and counterweights
- Fastening sliding door mechanisms for elevators
- Innovative V-shape provides high load resistance and close edge distances
- Only one HBC-C bolt type required for HAC-40 to HAC-70 channels

### Technical data

<b>Anchor type</b>	Anchor channel
<b>Environmental conditions</b>	Indoor, damp conditions
<b>Type of fastening</b>	Pre-fastening
<b>Material composition</b>	Steel, hot-dip galvanized (min. 70 µm)
<b>Width</b>	45 mm
<b>Height</b>	40 mm
<b>Material, corrosion</b>	Steel, sherardised / hot-dip galvanized

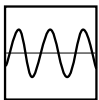

Ordering designation	Length	Number of anchors	Anchor distance	Standard embedment depth	Sales pack quantity	Item number
HAC-70 175/300 F	300 mm	2	250 mm	175 mm	1 pc	431860
HAC-70 175/350 F	350 mm	3	150 mm	175 mm	1 pc	431861
HAC-70 175/450 F	450 mm	3	200 mm	175 mm	1 pc	431862
HAC-70 175/550 F	550 mm	3	250 mm	175 mm	1 pc	431863
HAC-70 175/1050 F	1050 mm	5	250 mm	175 mm	1 pc	431864
HAC-70 175/1550 F	1550 mm	7	250 mm	175 mm	1 pc	2021269
HAC-70 175/2300 F	2300 mm	10	250 mm	175 mm	1 pc	431865
HAC-70 175/5800 F	5800 mm	24	250 mm	175 mm	1 pc	431866

### T-head bolt (galvanized) HBC-A

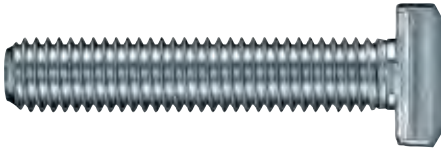

#### Key applications and advantages

- For use with HAC-10 and HAC-20 anchor channels
- European approval in accordance with the latest technical specifications
- Dustless, low-noise fastening method

#### Technical data

<b>Anchor type</b>	T-head bolt
<b>Environmental conditions</b>	Indoor, dry conditions
<b>Type of fastening</b>	Pre-fastening
<b>Material composition</b>	Steel, zinc-plated (min. 5 µm)
<b>Material, corrosion</b>	Steel, zinc-plated



Ordering designation	Anchor size	Useable thread length	Sales pack quantity	Item number
HBC-A M8x15 4.6G	M8	10 mm	150 pc	433482
HBC-A M8x20 4.6G	M8	15 mm	100 pc	433483
HBC-A M8x25 4.6G	M8	20 mm	100 pc	433484
HBC-A M8x30 4.6G	M8	25 mm	100 pc	433485
HBC-A M8x40 4.6G	M8	35 mm	150 pc	433486
HBC-A M10x25 4.6G	M10	19 mm	150 pc	433488
HBC-A M10x30 4.6G	M10	24 mm	100 pc	433489
HBC-A M10x40 4.6G	M10	34 mm	100 pc	433490
HBC-A M10x60 4.6G	M10	54 mm	100 pc	433491
HBC-A M10x100 4.6G	M10	94 mm	100 pc	433492
HBC-A M12x30 4.6G	M12	23 mm	100 pc	433493
HBC-A M12x40 4.6G	M12	33 mm	100 pc	433495
HBC-A M12x50 4.6G	M12	43 mm	100 pc	433496
HBC-A M12x60 4.6G	M12	53 mm	100 pc	433497
HBC-A M12x100 4.6G	M12	93 mm	100 pc	433499
HBC-A M12x150 4.6G	M12	143 mm	50 pc	433500

### Hot-dip galvanized T-head bolt HBC-A

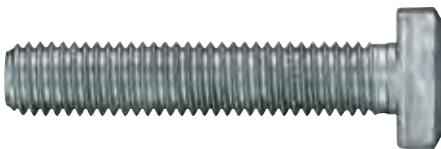

#### Key applications and advantages

- For use with HAC-10 and HAC-20 anchor channels
- European approval in accordance with the latest technical specifications
- Dustless, low-noise fastening method

#### Technical data

<b>Anchor type</b>	T-head bolt
<b>Environmental conditions</b>	Indoor, damp conditions
<b>Type of fastening</b>	Pre-fastening
<b>Material composition</b>	Steel, hot-dip galvanized (min. 45 µm)
<b>Material, corrosion</b>	Steel, sherardised / hot-dip galvanised



Ordering designation	Anchor size	Useable thread length	Sales pack quantity	Item number
HBC-A M10x30 4.6F	M10	24 mm	100 pc	433501
HBC-A M10x40 4.6F	M10	34 mm	100 pc	433502
HBC-A M10x60 4.6F	M10	54 mm	100 pc	433503
HBC-A M12x30 4.6F	M12	23 mm	100 pc	433504
HBC-A M12x60 4.6F	M12	53 mm	100 pc	433507
HBC-A M12x80 4.6F	M12	73 mm	100 pc	433508
HBC-A M12x100 4.6F	M12	93 mm	100 pc	433509

### T-head bolt (stainless) HBC-A

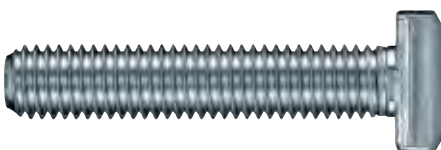

#### Key applications and advantages

- For use with HAC-10 and HAC-20 anchor channels
- European approval in accordance with the latest technical specifications
- Dustless, low-noise fastening method

#### Technical data

<b>Anchor type</b>	T-head bolt
<b>Environmental conditions</b>	Outdoor
<b>Type of fastening</b>	Pre-fastening
<b>Material composition</b>	Steel, A4
<b>Material, corrosion</b>	Steel, stainless



Ordering designation	Anchor size	Useable thread length	Sales pack quantity	Item number
HBC-A M10x20 50R	M10	14 mm	50 pc	433511
HBC-A M10x30 50R	M10	24 mm	50 pc	433513
HBC-A M10x40 50R	M10	34 mm	25 pc	433514
HBC-A M10x50 50R	M10	44 mm	25 pc	433515
HBC-A M10x80 50R	M10	74 mm	25 pc	433517
HBC-A M12x30 50R	M12	23 mm	25 pc	433518
HBC-A M12x50 50R	M12	43 mm	25 pc	433519
HBC-A M12x60 50R	M12	53 mm	25 pc	433521
HBC-A M12x80 50R	M12	73 mm	25 pc	433522
HBC-A M12x100 50R	M12	93 mm	25 pc	433523



Technical data	
Anchor type	T-head bolt
Environmental conditions	Indoor, dry conditions
Type of fastening	Pre-fastening
Material composition	Steel, 4.6 grade, zinc-plated (min. 8 µm)
Tooth configuration	Toothed
Material, corrosion	Steel, zinc-plated



**Key applications and advantages**

- For use with HAC-30 anchor channels
- Dustless, low-noise fastening method
- European approval in accordance with the latest technical specifications

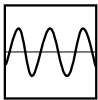

**T-head bolt (galvanized) HBC-B**

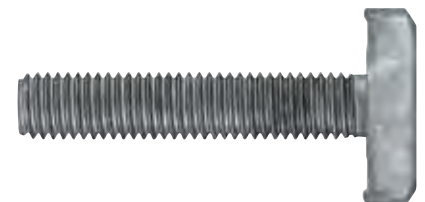

Ordering designation	Anchor size	Useable thread length	Sales pack quantity	Item number
HBC-B M10x40 4.6G	M10	33 mm	100 pc	433527
HBC-B M10x100 4.6G	M10	93 mm	100 pc	433529
HBC-B M12x40 4.6G	M12	30 mm	100 pc	433530
HBC-B M12x60 4.6G	M12	50 mm	100 pc	433531
HBC-B M12x80 4.6G	M12	70 mm	100 pc	433532
HBC-B M12x150 4.6G	M12	140 mm	50 pc	433533

**Hot-dip galvanized T-head bolt HBC-B**



Key applications and advantages	
■ For use with HAC-30 anchor channels	
■ Dustless, low-noise fastening method	
■ European approval in accordance with the latest technical specifications	

Technical data	
Anchor type	T-head bolt
Environmental conditions	Outdoor
Type of fastening	Pre-fastening
Material composition	Steel, 4.6 grade, hot-dip galvanized (min. 45 µm)
Tooth configuration	Toothed
Material, corrosion	Steel, sherardised / hot-dip galvanised

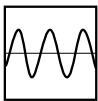

Ordering designation	Anchor size	Useable thread length	Sales pack quantity	Item number
HBC-B M12x60 4.6F	M12	50 mm	100 pc	433535
HBC-B M12x100 4.6F	M12	90 mm	100 pc	433536



## Galvanized T-head bolt HBC-C 4.6

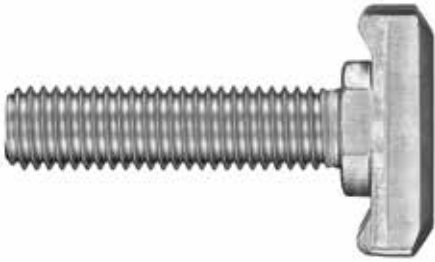

### Key applications and advantages

- European Technical Approval according to the latest technical specifications
- Simplification of the available range  
Only one universal bolt needed to cover all channel geometries from HAC-40 to HAC-70

### Technical data

<b>Anchor type</b>	T-head bolt
<b>Environmental conditions</b>	Indoor, dry conditions
<b>Type of fastening</b>	Pre-fastening
<b>Material composition</b>	Steel, 4.6 grade, zinc-plated (min. 8 µm)
<b>Material, corrosion</b>	Steel, zinc-plated

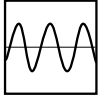

Ordering designation	Anchor size	Useable thread length	Sales pack quantity	Item number
HBC-C M10x30 4.6G	M10	21 mm	100 pc	434353
HBC-C M10x40 4.6G	M10	31 mm	100 pc	434354
HBC-C M10x50 4.6G	M10	41 mm	100 pc	434355
HBC-C M10x60 4.6G	M10	51 mm	100 pc	434356
HBC-C M10x70 4.6G	M10	61 mm	100 pc	434358
HBC-C M10x80 4.6G	M10	71 mm	100 pc	434359
HBC-C M10x100 4.6G	M10	91 mm	100 pc	434360
HBC-C M12x30 4.6G	M12	21 mm	100 pc	434362
HBC-C M12x80 4.6G	M12	71 mm	100 pc	434366
HBC-C M12x100 4.6G	M12	91 mm	100 pc	434367
HBC-C M12x125 4.6G	M12	116 mm	50 pc	434368
HBC-C M16x30 4.6G	M16	20 mm	100 pc	434369
HBC-C M16x50 4.6G	M16	40 mm	100 pc	434371
HBC-C M16x80 4.6G	M16	70 mm	50 pc	434373
HBC-C M16x100 4.6G	M16	90 mm	50 pc	434374
HBC-C M16x125 4.6G	M16	115 mm	50 pc	434375
HBC-C M16x150 4.6G	M16	140 mm	50 pc	434376
HBC-C M16x200 4.6G	M16	190 mm	50 pc	434377

## T-head bolt (galvanized) HBC-C

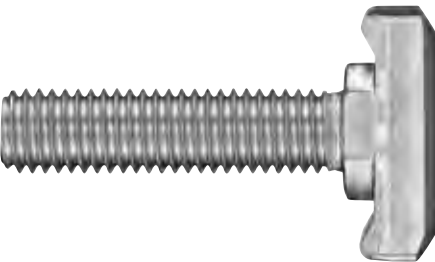

### Key applications and advantages

- For use with HAC-40 to HAC-70 anchor channels
- European approval according to latest technical specifications
- Dustless and noiseless fastening method

### Technical data

<b>Anchor type</b>	T-head bolt
<b>Environmental conditions</b>	Indoor, dry conditions
<b>Type of fastening</b>	Pre-fastening
<b>Material composition</b>	Steel, 8.8 grade, zinc-plated (min. 8 µm)
<b>Material, corrosion</b>	Steel, zinc-plated



Ordering designation	Anchor size	Useable thread length	Sales pack quantity	Item number
HBC-C M16x50 8.8G	M16	40 mm	100 pc	434378
HBC-C M16x60 8.8G	M16	50 mm	100 pc	434379
HBC-C M16x70 8.8G	M16	60 mm	100 pc	434380
HBC-C M16x80 8.8G	M16	70 mm	50 pc	434381
HBC-C M16x100 8.8G	M16	90 mm	50 pc	434382

### Hot-dip galvanized T-head bolt HBC-C



#### Key applications and advantages

- European Technical Approval according to the latest technical specifications

#### Technical data

<b>Anchor type</b>	T-head bolt
<b>Environmental conditions</b>	Indoor, damp conditions
<b>Type of fastening</b>	Pre-fastening
<b>Material composition</b>	Steel, 4.6 grade, hot-dip galvanized (min. 45 µm)
<b>Material, corrosion</b>	Steel, sherardised / hot-dip galvanized



Ordering designation	Anchor size	Useable thread length	Sales pack quantity	Item number
HBC-C M10x30 4.6F	M10	21 mm	100 pc	434383
HBC-C M12x30 4.6F	M12	21 mm	100 pc	434385
HBC-C M12x40 4.6F	M12	31 mm	100 pc	434386
HBC-C M12x50 4.6F	M12	41 mm	100 pc	434387
HBC-C M12x60 4.6F	M12	51 mm	100 pc	434388
HBC-C M12x100 4.6F	M12	91 mm	100 pc	434389
HBC-C M16x40 4.6F	M16	30 mm	100 pc	434390
HBC-C M16x50 4.6F	M16	40 mm	100 pc	434391
HBC-C M16x60 4.6F	M16	50 mm	100 pc	434392
HBC-C M16x70 4.6F	M16	60 mm	100 pc	434393
HBC-C M16x80 4.6F	M16	70 mm	50 pc	434394
HBC-C M16x100 4.6F	M16	90 mm	50 pc	434395
HBC-C M20x60 4.6F	M20	48 mm	50 pc	434397
HBC-C M20x80 4.6F	M20	68 mm	50 pc	434398
HBC-C M20x100 4.6F	M20	88 mm	50 pc	434399
HBC-C M20x150 4.6F	M20	138 mm	25 pc	434400

### Hot-dip galvanized T-head bolt HBC-C

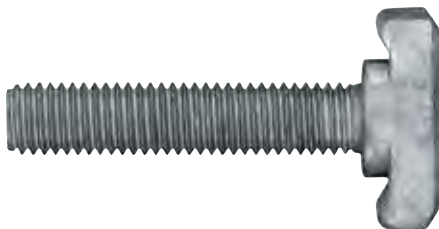

#### Key applications and advantages

- For use with HAC-40 to HAC-70 anchor channels
- Simplification of the range available  
Only one universal bolt type needed to cover HAC-40 to HAC-70 anchor channels
- European approval according to latest technical specifications

#### Technical data

<b>Anchor type</b>	T-head bolt
<b>Environmental conditions</b>	Indoor, damp conditions
<b>Type of fastening</b>	Pre-fastening
<b>Material composition</b>	Steel, 8.8 grade, hot-dip galvanized (min. 45 µm)
<b>Material, corrosion</b>	Steel, sherardised / hot-dip galvanized

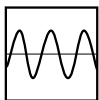

Ordering designation	Anchor size	Useable thread length	Sales pack quantity	Item number
HBC-C M12x40 8.8F	M12	31 mm	100 pc	434401
HBC-C M12x50 8.8F	M12	41 mm	100 pc	434402
HBC-C M12x60 8.8F	M12	51 mm	100 pc	434403
HBC-C M12x80 8.8F	M12	71 mm	100 pc	2019732
HBC-C M16x60 8.8F	M16	50 mm	100 pc	434405
HBC-C M16x80 8.8F	M16	70 mm	50 pc	434406
HBC-C M16x100 8.8F	M16	90 mm	50 pc	434407
HBC-C M20x60 8.8F	M20	48 mm	50 pc	434408
HBC-C M20x100 8.8F	M20	88 mm	50 pc	434409
HBC-C M20x125 8.8F	M20	113 mm	25 pc	434410
HBC-C M20x150 8.8F	M20	138 mm	25 pc	434411

## T-head bolt (stainless steel) HBC-C

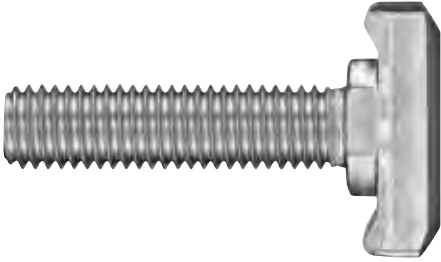

### Key applications and advantages

- For use with HAC-40 to HAC-70 anchor channels
- Simplification of the range available  
Only one universal bolt type needed to cover HAC-40 to HAC-70 anchor channels
- European approval according to latest technical specifications

### Technical data

<b>Anchor type</b>	T-head bolt
<b>Environmental conditions</b>	Outdoor
<b>Type of fastening</b>	Pre-fastening
<b>Material composition</b>	Steel, A4
<b>Material, corrosion</b>	Steel, stainless



Ordering designation	Anchor size	Useable thread length	Sales pack quantity	Item number
HBC-C M10x30 50R	M10	21 mm	50 pc	433459
HBC-C M10x40 50R	M10	31 mm	25 pc	433460
HBC-C M10x50 50R	M10	41 mm	25 pc	433461
HBC-C M12x30 50R	M12	21 mm	25 pc	433462
HBC-C M12x40 50R	M12	31 mm	25 pc	433463
HBC-C M12x50 50R	M12	41 mm	25 pc	433465
HBC-C M12x80 50R	M12	71 mm	25 pc	433466
HBC-C M12x100 50R	M12	91 mm	25 pc	433467
HBC-C M12x125 50R	M12	116 mm	25 pc	433468
HBC-C M16x30 50R	M16	20 mm	50 pc	433469
HBC-C M16x40 50R	M16	30 mm	50 pc	433470
HBC-C M16x50 50R	M16	40 mm	50 pc	433471
HBC-C M16x60 50R	M16	50 mm	50 pc	433472
HBC-C M16x65 50R	M16	55 mm	50 pc	433473
HBC-C M16x80 50R	M16	70 mm	25 pc	433474
HBC-C M16x100 50R	M16	90 mm	25 pc	433475
HBC-C M16x125 50R	M16	115 mm	25 pc	433476
HBC-C M16x150 50R	M16	140 mm	25 pc	433477

## T-head bolt (galvanized) HBC-C-E

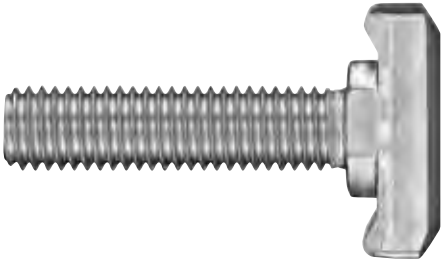

### Key applications and advantages

- Special geometry for elevator applications
- For use with HAC-40 to HAC-70 anchor channels
- Simplification of the available range  
Only one universal bolt type needed to cover HAC-40 to HAC-70 anchor channel
- Dustless, low-noise fastening method

### Technical data

<b>Anchor type</b>	T-head bolt
<b>Environmental conditions</b>	Indoor, dry conditions
<b>Type of fastening</b>	Pre-fastening
<b>Material composition</b>	Steel, 8.8 grade, zinc-plated (min. 8 µm)
<b>Material, corrosion</b>	Steel, zinc-plated



Ordering designation	Anchor size	Useable thread length	Sales pack quantity	Item number
HBC-C-E M12x40 8.8G	M12	30 mm	100 pc	433538
HBC-C-E M12x50 8.8G	M12	40 mm	100 pc	433539
HBC-C-E M12x60 8.8G	M12	50 mm	100 pc	433540
HBC-C-E M12x100 8.8G	M12	90 mm	100 pc	433541
HBC-C-E M12x150 8.8G	M12	140 mm	50 pc	433542
HBC-C-E M16x50 8.8G	M16	38 mm	100 pc	433543
HBC-C-E M16x60 8.8G	M16	48 mm	100 pc	434347
HBC-C-E M16x80 8.8G	M16	68 mm	50 pc	434348
HBC-C-E M16x100 8.8G	M16	88 mm	50 pc	434349
HBC-C-E M16x125 8.8G	M16	113 mm	50 pc	434350
HBC-C-E M16x150 8.8G	M16	138 mm	50 pc	434351
HBC-C-E M16x290 8.8G	M16	278 mm	25 pc	434352

## Hot-dip galvanized T-head bolt HBC-C-N

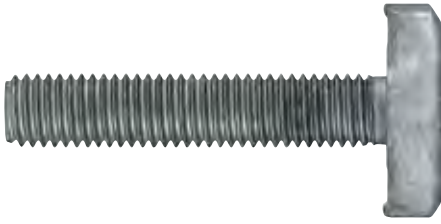

### Key applications and advantages

- For use with HAC-40 to HAC-70 anchor channels
- Simplification of the available range  
Only one universal bolt type needed to cover HAC-40 to HAC-70 anchor channel
- Toothed bolts for reliable load transfer in a longitudinal direction

### Technical data

<b>Anchor type</b>	T-head bolt
<b>Environmental conditions</b>	Indoor, damp conditions
<b>Type of fastening</b>	Pre-fastening
<b>Material composition</b>	Steel, 8.8 grade, hot-dip galvanized (min. 45 µm)
<b>Tooth configuration</b>	Notched
<b>Material, corrosion</b>	Steel, sherardised / hot-dip galvanized



Ordering designation	Anchor size	Useable thread length	Sales pack quantity	Item number
HBC-C-N M16x50 8.8F	M16	40 mm	100 pc	433478
HBC-C-N M16x60 8.8F	M16	50 mm	100 pc	2019736
HBC-C-N M16x80 8.8F	M16	70 mm	50 pc	433479
HBC-C-N M20x60 8.8F	M20	47 mm	50 pc	434345
HBC-C-N M20x100 8.8F	M20	87 mm	50 pc	434346

### Anchor rod (rail anchor) HRC



#### Key applications and advantages

- For fastening rails to concrete slabs
- For bottom up (post-installed) construction method
- For light/urban and heavy rail
- Corrosion resistant
- High electrical insulation values with regard to stray current

#### Technical data

<b>Anchor type</b>	Post-installed
<b>Head configuration</b>	Externally threaded
<b>Type of fastening</b>	Through-fastening
<b>Tested/approved for diamond drilling</b>	Yes

Ordering designation	Anchor size	Maximum axial load	Maximum fastening height	Standard embedment depth	Drilling depth	Sales pack quantity	Item number
HRC-BR M22x238 assy	M22	250 kN		106 mm	110 mm	10 pc	288489
HRC-BR M22X263	M22	250 kN		106 mm	110 mm	10 pc	288762
HRC M22X215 (26)	M22	250 kN	40 mm	106 mm	110 mm	10 pc	251674

### Anchor rod HRT-IP



#### Key applications and advantages

- For fastening rails to concrete slabs
- For top down (cast-in) construction method
- For light/urban and heavy rail
- Corrosion resistant
- High electrical insulation values with regard to stray current

#### Technical data

<b>Anchor type</b>	Cast-in
<b>Head configuration</b>	Hex head

Ordering designation	Anchor size	Maximum axial load	Sales pack quantity	Item number
HRT-IP M22x190	M22	180 kN	5 pc	2004599
HRT-IP M22x175	M22	180 kN	5 pc	2004660
HRT-IP M22x185	M22	180 kN	5 pc	2004662
HRT-IP M22x210	M22	180 kN	5 pc	2004681
HRT-I M22x200	M22	180 kN	5 pc	2046956
HRT-IP M27x240	M27	250 kN	10 pc	2020804

### Rail anchor HRT-I



#### Key applications and advantages

- For fastening rails to concrete slabs
- For bottom up (post-installed) construction method
- For light/urban and heavy rail
- Corrosion resistant
- High electrical insulation values help avoid stray electric currents

#### Technical data

<b>Anchor type</b>	Post-installed
<b>Head configuration</b>	Hex head
<b>Type of fastening</b>	Through-fastening
<b>Tested/approved for diamond drilling</b>	Yes

Ordering designation	Anchor size	Maximum axial load	Standard embedment depth	Drilling depth	Sales pack quantity	Item number
HRT-I M22x175	M22	180 kN	120 mm	125 mm	5 pc	2004596
HRT-I M22x185	M22	180 kN	120 mm	125 mm	5 pc	2004661
HRT-I M22x210	M22	180 kN	120 mm	125 mm	5 pc	2004682
HRT-I M22x200 exc	M22	180 kN	120 mm	125 mm	10 pc	2049479
HRT-I M22x190	M22	180 kN	120 mm	125 mm	20 pc	2004598
HRT-I M27x240	M27	250 kN	150 mm	155 mm	10 pc	2020803

### Sleeve (repair anchor) HRS



#### Key applications and advantages

- Refurbishment of wooden sleepers
- For hardwood and softwood sleepers
- Superior mechanical properties in terms of tensile strength, flexural strength, flexural modulus, hardness, impact strength and temperature behaviour
- Simple, quick and problem-free installation without special tools

#### Technical data

<b>Anchor type</b>	Post-installed
--------------------	----------------

Ordering designation	Sales pack quantity	Item number
HRS-22	100 pc	216962