



The following excerpt are pages from the North American Product Technical Guide, Volume 2: Anchor Fastening, Edition 22.

Please refer to the publication in its entirety for complete details on this product including data development, product specifications, general suitability, installation, corrosion and spacing and edge distance guidelines.

US&CA: <https://submittals.us.hilti.com/PTGVol2/>

To consult directly with a team member regarding our anchor fastening products, contact Hilti's team of technical support specialists between the hours of 7:00am – 6:00pm CST.

US: 877-749-6337 or HNATechnicalServices@hilti.com

CA: 1-800-363-4458, ext. 6 or CATechnicalServices@hilti.com

3.3.5 KWIK BOLT TZ2 EXPANSION ANCHOR

PRODUCT DESCRIPTION

KWIK BOLT TZ2 Expansion anchor

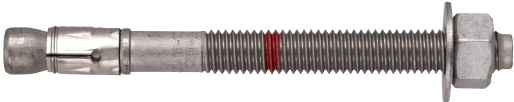
Anchor System	Features and Benefits
 <p>Carbon steel KB-TZ2</p>  <p>Stainless Steel 304/316 KB-TZ2</p>	<ul style="list-style-type: none"> • IFU provides multiple installation methods including no hole cleaning with hammer drill, Hilti Dust Removal System (DRS) for virtually dustless installation (OSHA 1926.1153 Table 1 compliant) and core drilling installation. • More accurate SafeSet™ installation when using the Hilti SIW-6AT-A22 impact wrench and the SI-AT-A22 Adaptive Torque Module. • Product and length identification marks help facilitate quality control after installation. • Maximized thread lengths and multiple embedment depths to accommodate various base plate thicknesses. • Mechanical expansion allows immediate load application. • Raised impact section (dog point) helps protect threads from damage during installation. • Bolt meets ductility requirements of ACI 318 Section 2.3. • Functional coatings and profile on expansion wedges provide increased reliability.

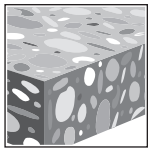

Uncracked concrete

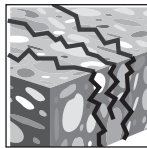

Cracked concrete

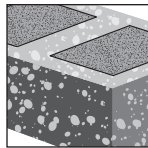

Grout-filled concrete masonry

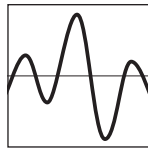

Seismic Design Categories A-F

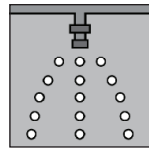

Fire sprinkler listings



Profis Engineering design software



Hollow Drill Bit and Adaptive Torque Tool (AT)

Approvals/ Listings

ICC-ES (International Code Council) <ul style="list-style-type: none"> • 2021 International Building Code / International Residential Code (IBC/IRC) • 2015 National Building Code of Canada (NBC-C) 	ESR-4266 in concrete per ACI 318 Ch. 17 / ACI 355.2/ ICC-ES AC193 ESR-4561 in grout-filled CMU per ICC-ES AC01 ELC-4266 in concrete per CSA A23.3 / ACI 355.2
City of Los Angeles	2020 LABC Supplement (within ESR-4266 & ESR-4561)
Florida Building Code	2020 FBC Supplement with HVHZ (within ESR-4266 & ESR-4561)
FM (Factory Mutual) – Carbon steel KB-TZ2 only	Pipe hanger components for automatic sprinkler systems 3/8 (up to 4-inch nominal pipe diameter) 1/2 ¹ (up to 8-inch nominal pipe diameter) 3/4 (up to 12-inch nominal pipe diameter)
UL and cUL (Underwriters Laboratory) – Carbon steel KB-TZ2 only	Pipe hanger equipment for fire protection services 3/8 (up to 4-inch nominal pipe diameter) 1/2 ¹ (up to 8-inch nominal pipe diameter) 5/8 & 3/4 (up to 12-inch nominal pipe diameter)
ANSI/MSS SP-58-2018	Anchors conform to ANSI/MSSP-58-2018. Contact Hilti for more information.



Pipe Hanger 757G

1 1/2-inch dia. with 1-1/2-inch effective embedment does not have FM or UL certification.

MATERIAL SPECIFICATIONS

Carbon steel with electroplated zinc-nickel plating

- Carbon steel anchor components plated in accordance with ASTM F1941 to a minimum thickness of 5 µm.
- Nuts conform to the requirements of ASTM A563, Grade A, Hex.
- Washers meet the requirements of ASTM F844.
- Expansion sleeves (wedges) are manufactured from carbon or stainless steel.
- Nuts and bolts are finished with a proprietary coating. Only Hilti KB-TZ2 nuts can be used with KB-TZ2 bolts.
- Carbon steel bolts are manufactured from carbon steel.

Stainless steel

- All nuts and washers for type 304 anchors are made from type 304 stainless.
- All nuts and washers for type 316 anchors are made from type 316 stainless.
- Nuts meet the dimensional requirements of ASTM F594.
- Washers meet the dimensional requirements of ANSI B18.22.1, Type A, plain.
- Expansion sleeve (wedges) are made from stainless steel.
- Nuts and bolts are finished with a proprietary coating. Only Hilti KB-TZ2 nuts can be used with KB-TZ2 bolts.
- Stainless steel 304 bolts are manufactured from AISI Type 304 stainless steel.
- Stainless steel 316 bolts are manufactured from AISI Type 316 stainless steel.

INSTALLATION PARAMETERS

Table 1 – Hilti KB-TZ2 setting information for installation in concrete and grout-filled concrete masonry units (CMU)¹

3.3.5

Setting information		Symbol	Units	Nominal anchor diameter (in)															
				1/4	3/8		1/2		5/8		3/4		1						
Nominal bit diameter		d _o	in.	1/4	3/8		1/2		5/8		3/4		1						
Effective minimum embedment		h _{ef}	in. (mm)	1-1/2 (38)	1-1/2 (38)	2 (51)	2-1/2 (64)	1-1/2 ² (38)	2 (51)	2-1/2 (64)	3-1/4 (83)	2-3/4 (70)	3-1/4 (83)	4 (102)	3-1/4 (83)	3-3/4 (95)	4-3/4 (121)	4 (102)	5-3/4 (146)
Nominal minimum embedment		h _{nom}	in. (mm)	1-3/4 (44)	1-7/8 (48)	2-1/2 (64)	3 (76)	2 2 (51)	2-1/2 (64)	3 (76)	3-3/4 (95)	3-1/4 (83)	3-3/4 (95)	4-1/2 (114)	4 (102)	4-1/2 (114)	5-1/2 (140)	4-5/8 (117)	6-3/8 (162)
Min. hole depth		h _o	in. (mm)	2 (51)	2 (51)	2-3/4 (70)	3-1/4 (83)	2-1/4 ² (57)	2-3/4 (70)	3-1/4 (83)	4-1/4 (108)	3-3/4 (95)	4-1/4 (108)	4-3/4 (121)	4-1/4 (108)	4-3/4 (121)	5-3/4 (146)	5 (127)	6-3/4 (171)
Fixture hole diameter		d _h	in. (mm)	5/16 (7.9)	7/16 (11.1)		9/16 (14.3)		11/16 (17.5)		13/16 (20.6)		1-1/8 (28.6)						
Concrete	Installation torque Carbon steel	T _{inst,conc}	ft-lb (Nm)	4 (5)	30 (41)		50 (68)		40 (54)		110 (149)		185 (251)						
	Installation torque Stainless steel	T _{inst,conc}	ft-lb (Nm)	6 (8)	30 (41)		40 (54)		60 (81)		125 (169)		185 (251)						
Grout-filled CMU	Installation torque Carbon steel	T _{inst,CMU}	ft-lb (Nm)	4 (5)	15 (20)		25 (34)		30 (41)		50 (68)		N/A N/A						
	Installation torque Stainless steel	T _{inst,CMU}	ft-lb (Nm)	6 (8)	15 (20)		25 (34)		35 (48)		50 (68)		N/A N/A						

1 Shaded cells are not applicable for installations in grout-filled CMU.
 2 Design information for h_{ef} = 1-1/2 is only applicable to carbon steel (CS) KB-TZ2 bolts.

Hilti KWIK Bolt TZ2 Fracture Load (lb)¹

Nominal Anchor Diameter (in)	Carbon Steel	Stainless Steel
1/4	2920	2920
3/8	6490	6180
1/2	11240	11870
5/8	17535	18835
3/4	25335	f _{uta} ≥ 105, f _y ≥ 84 ²
1	f _{uta} ≥ 88, f _y ≥ 75 ²	f _{uta} ≥ 99.9, f _y ≥ 65 ²

1 Bolt fracture loads are determined by testing in a universal tensile machine for quality control at the manufacturing facility. These loads are not intended for design use.
 2 All 3/4-in. stainless steel, all 1-in. carbon steel and all 1-in. stainless steel material strengths specified by the tensile and yield strengths expressed in (ksi). Bolt fracture loads not applicable for these models.

Figure 1 — Hilti KWIK Bolt TZ 2 specifications

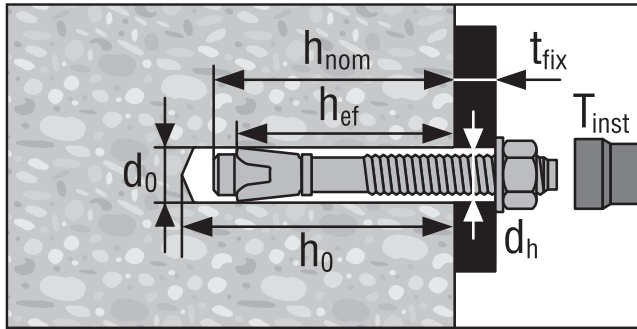

DESIGN INFORMATION IN CONCRETE PER ACI 318

ACI 318 Chapter 17 Design

The load values contained in this section are Hilti Simplified Design Tables. The load tables in this section were developed using the Strength Design parameters and variables of ICC-ES ESR-4266 and the equations within ACI 318 Chapter 17. For a detailed explanation of the Hilti Simplified Design Tables refer to section 3.1.8. Data tables from ESR-4266 are not contained in this section but can be found at www.icc-es.org or at www.hilti.com

Table 2 — Hilti Carbon Steel KB-TZ2 design strength based on concrete failure modes in uncracked concrete per ACI 318 Ch. 17, applicable for both hammer and core drilled installations^{1,2,3,4}

Nominal anchor diameter in.	Effective embedment in. (mm)	Nominal embedment in. (mm)	Tension (lesser of concrete breakout / pullout) - ΦN_n				Shear (lesser of concrete breakout or pryout) - ΦV_n			
			$f'_c = 2,500$ psi (17.2 MPa) lb (kN)	$f'_c = 3,000$ psi (20.7 MPa) lb (kN)	$f'_c = 4,000$ psi (27.6 MPa) lb (kN)	$f'_c = 6,000$ psi (41.1 MPa) lb (kN)	$f'_c = 2,500$ psi (17.2 MPa) lb (kN)	$f'_c = 3,000$ psi (20.7 MPa) lb (kN)	$f'_c = 4,000$ psi (27.6 MPa) lb (kN)	$f'_c = 6,000$ psi (41.1 MPa) lb (kN)
1/4	1-1/2 (38)	1 3/4 (44)	945 (4.2)	980 (4.4)	1,040 (4.6)	1,125 (5.0)	1,545 (6.9)	1,690 (7.5)	1,950 (8.7)	2,390 (10.6)
	1-1/2 (38)	1 7/8 (48)	1,435 (6.4)	1,570 (7.0)	1,815 (8.1)	2,220 (9.9)	1,545 (6.9)	1,690 (7.5)	1,950 (8.7)	2,390 (10.6)
3/8	2 (51)	2 1/2 (64)	2,205 (9.8)	2,415 (10.7)	2,790 (12.4)	3,420 (15.2)	2,375 (10.6)	2,605 (11.6)	3,005 (13.4)	3,680 (16.4)
	2-1/2 (64)	3 (76)	2,715 (12.1)	2,895 (12.9)	3,205 (14.3)	3,690 (16.4)	6,640 (29.5)	7,275 (32.4)	8,400 (37.4)	10,290 (45.8)
1/2	1-1/2 (38)	2 (51)	1,610 (7.2)	1,765 (7.9)	2,040 (9.1)	2,495 (11.1)	1,735 (7.7)	1,900 (8.5)	2,195 (9.8)	2,690 (12.0)
	2 (51)	2 1/2 (64)	2,480 (11.0)	2,720 (12.1)	3,140 (14.0)	3,845 (17.1)	2,675 (11.9)	2,930 (13.0)	3,380 (15.0)	4,140 (18.4)
	2-1/2 (64)	3 (76)	3,085 (13.7)	3,375 (15.0)	3,900 (17.3)	4,775 (21.2)	6,640 (29.5)	7,275 (32.4)	8,400 (37.4)	10,290 (45.8)
	3-1/4 (83)	3 3/4 (95)	4,570 (20.3)	5,005 (22.3)	5,780 (25.7)	7,080 (31.5)	9,845 (43.8)	10,785 (48.0)	12,450 (55.4)	15,250 (67.8)
5/8	2-3/4 (70)	3 1/4 (83)	3,495 (15.5)	3,830 (17.0)	4,425 (19.7)	5,420 (24.1)	7,660 (34.1)	8,395 (37.3)	9,690 (43.1)	11,870 (52.8)
	3-1/4 (83)	3 3/4 (95)	4,570 (20.3)	5,005 (22.3)	5,780 (25.7)	7,080 (31.5)	9,845 (43.8)	10,785 (48.0)	12,450 (55.4)	15,250 (67.8)
	4 (102)	4 1/2 (114)	5,845 (26.0)	6,405 (28.5)	7,395 (32.9)	9,060 (40.3)	13,440 (59.8)	14,725 (65.5)	17,000 (75.6)	20,820 (92.6)
3/4	3-1/4 (83)	4 (102)	5,140 (22.9)	5,630 (25.0)	6,505 (28.9)	7,965 (35.4)	11,075 (49.3)	12,130 (54.0)	14,005 (62.3)	17,155 (76.3)
	3-3/4 ⁵ (95)	4 1/2 (114)	6,370 (28.3)	6,980 (31.0)	8,060 (35.9)	9,870 (43.9)	13,725 (61.1)	15,035 (66.9)	17,360 (77.2)	21,265 (94.6)
	4-3/4 (121)	5 1/2 (140)	8,075 (35.9)	8,845 (39.3)	10,215 (45.4)	12,510 (55.6)	17,390 (77.4)	19,050 (84.7)	22,000 (97.9)	26,945 (119.9)
1	4 (102)	4 5/8 (117)	7,020 (31.2)	7,690 (34.2)	8,880 (39.5)	10,875 (48.4)	15,120 (67.3)	16,565 (73.7)	19,125 (85.1)	23,425 (104.2)
	5-3/4 (146)	6 3/8 (162)	10,755 (47.8)	11,780 (52.4)	13,605 (60.5)	16,660 (74.1)	23,165 (103.0)	25,375 (112.9)	29,300 (130.3)	35,885 (159.6)

1 See Section 3.1.8 to convert design strength value to ASD value.

2 Linear interpolation between embedment depths and concrete compressive strengths is not permitted.

3 Apply spacing, edge distance, and concrete thickness factors in tables 6 to 15 as necessary. Compare to the steel values in table 4. The lesser of the values is to be used for the design.

4 Tabular values are for normal weight concrete only. For lightweight concrete multiply design strength by λ_n as follows: For sand-lightweight, $\lambda_n = 0.68$; for all-lightweight, $\lambda_n = 0.60$.

5 For core drilled installations of 3/4" anchors installed at 3-3/4" effective embedment, apply a reduction factor of 0.89 to the design tension strength.

Table 3 – Hilti Carbon Steel KB-TZ2 design strength based on concrete failure modes in cracked concrete per ACI 318 Ch. 17, applicable for both hammer and core drilled installations^{1,2,3,4,5}

Nominal anchor diameter in.	Effective embedment in. (mm)	Nominal embedment in. (mm)	Tension (lesser of concrete breakout / pullout) - ΦN_n				Shear (lesser of concrete breakout or pryout) - ΦV_n			
			$f'_c = 2,500$ psi (17.2 MPa) lb (kN)	$f'_c = 3,000$ psi (20.7 MPa) lb (kN)	$f'_c = 4,000$ psi (27.6 MPa) lb (kN)	$f'_c = 6,000$ psi (41.1 MPa) lb (kN)	$f'_c = 2,500$ psi (17.2 MPa) lb (kN)	$f'_c = 3,000$ psi (20.7 MPa) lb (kN)	$f'_c = 4,000$ psi (27.6 MPa) lb (kN)	$f'_c = 6,000$ psi (41.1 MPa) lb (kN)
1/4	1-1/2 (38)	1 3/4 (44)	280 (1.2)	300 (1.3)	340 (1.5)	395 (1.8)	1,095 (4.9)	1,195 (5.3)	1,385 (6.2)	1,695 (7.5)
	3/8	1 7/8 (48)	1,255 (5.6)	1,375 (6.1)	1,585 (7.1)	1,940 (8.6)	1,350 (6.0)	1,480 (6.6)	1,710 (7.6)	2,090 (9.3)
3/8	2 (51)	2 1/2 (64)	1,930 (8.6)	2,115 (9.4)	2,440 (10.9)	2,990 (13.3)	2,080 (9.3)	2,275 (10.1)	2,630 (11.7)	3,220 (14.3)
	2-1/2 (64)	3 (76)	2,185 (9.7)	2,390 (10.6)	2,765 (12.3)	3,385 (15.1)	4,705 (20.9)	5,155 (22.9)	5,950 (26.5)	7,285 (32.4)
1/2	1-1/2 (38)	2 (51)	1,435 (6.4)	1,570 (7.0)	1,815 (8.1)	2,220 (9.9)	1,545 (6.9)	1,690 (7.5)	1,950 (8.7)	2,390 (10.6)
	2 (51)	2 1/2 (64)	1,930 (8.6)	2,115 (9.4)	2,440 (10.9)	2,990 (13.3)	2,080 (9.3)	2,275 (10.1)	2,630 (11.7)	3,220 (14.3)
	2-1/2 (64)	3 (76)	2,700 (12.0)	2,955 (13.1)	3,415 (15.2)	4,180 (18.6)	5,810 (25.8)	6,365 (28.3)	7,350 (32.7)	9,000 (40.0)
	3-1/4 (83)	3 3/4 (95)	3,235 (14.4)	3,545 (15.8)	4,095 (18.2)	5,015 (22.3)	6,970 (31.0)	7,640 (34.0)	8,820 (39.2)	10,800 (48.0)
5/8	2-3/4 (70)	3 1/4 (83)	3,110 (13.8)	3,410 (15.2)	3,935 (17.5)	4,820 (21.4)	6,705 (29.8)	7,345 (32.7)	8,480 (37.7)	10,385 (46.2)
	3-1/4 (83)	3 3/4 (95)	4,000 (17.8)	4,380 (19.5)	5,060 (22.5)	6,195 (27.6)	8,615 (38.3)	9,435 (42.0)	10,895 (48.5)	13,345 (59.4)
	4 (102)	4 1/2 (114)	4,420 (19.7)	4,840 (21.5)	5,590 (24.9)	6,845 (30.4)	9,520 (42.3)	10,430 (46.4)	12,040 (53.6)	14,750 (65.6)
3/4	3-1/4 (83)	4 (102)	4,000 (17.8)	4,380 (19.5)	5,060 (22.5)	6,195 (27.6)	8,615 (38.3)	9,435 (42.0)	10,895 (48.5)	13,345 (59.4)
	3-3/4 (95)	4 1/2 (114)	4,955 (22.0)	5,430 (24.2)	6,270 (27.9)	7,680 (34.2)	10,675 (47.5)	11,695 (52.0)	13,505 (60.1)	16,540 (73.6)
	4-3/4 (121)	5 1/2 (140)	5,745 (25.6)	6,055 (26.9)	6,580 (29.3)	7,405 (32.9)	15,220 (67.7)	16,670 (74.2)	19,250 (85.6)	23,575 (104.9)
1	4 (102)	4 5/8 (117)	5,460 (24.3)	5,980 (26.6)	6,905 (30.7)	8,460 (37.6)	11,760 (52.3)	12,880 (57.3)	14,875 (66.2)	18,220 (81.0)
	5-3/4 (146)	6 3/8 (162)	7,675 (34.1)	8,410 (37.4)	9,710 (43.2)	11,890 (52.9)	20,270 (90.2)	22,205 (98.8)	25,640 (114.1)	31,400 (139.7)

3.3.5

1 See Section 3.1.8 to convert design strength value to ASD value.
 2 Linear interpolation between embedment depths and concrete compressive strengths is not permitted.
 3 Apply spacing, edge distance, and concrete thickness factors in tables 6 to 17 as necessary. Compare to the steel values in table 4. The lesser of the values is to be used for the design.
 4 Tabular values are for normal weight concrete only. For lightweight concrete multiply design strength by λ_s as follows: For sand-lightweight, $\lambda_s = 0.68$; for all-lightweight, $\lambda_s = 0.60$.
 5 Tabular values are for static loads only. Seismic design is not permitted for uncracked concrete. For seismic tension loads, multiply cracked concrete tabular values in tension only by $\alpha_{N,seis} = 0.75$, except for 3/4 x 4-3/4 h_{ef} where $\alpha_{N,seis} = 0.73$. No reduction needed for seismic shear. See Section 3.1.8 for additional information on seismic applications.

Table 4 — Hilti Carbon Steel KB-TZ2 design strength based on steel failure per ACI 318 Ch. 17 ^{1,2}

Nominal anchor diameter in.	Effective embedment depth in. (mm)			Tensile ³ ΦN _{sa} lb (kN)	Shear ⁴ ΦV _{sa} lb (kN)	Seismic Shear ⁵ ΦV _{sa} lb (kN)
1/4	1-1/2 (38)			2,190 (9.7)	875 (3.9)	875 (3.9)
3/8	1-1/2 (38)			4,870 (21.7)	2,095 (9.3)	2,095 (9.3)
3/8	2 (51)	2-1/2 (64)		4,870 (21.7)	2,200 (9.8)	2,200 (9.8)
1/2	1-1/2 (38)	2 (51)		8,430 (37.5)	3,600 (16.0)	3,600 (16.0)
1/2	2-1/2 (64)		3-1/4 (83)	8,430 (37.5)	4,470 (19.9)	4,470 (19.9)
5/8	2-3/4 (70)	3-1/4 (83)	4 (102)	13,150 (58.5)	6,665 (29.6)	6,665 (29.6)
3/4	3-1/4 (83)	3-3/4 (95)	4-3/4 (121)	19,000 (84.5)	8,975 (39.9)	8,975 (39.9)
1 (25.4)	4 (102)			31,025 (138.0)	12,215 (54.3)	8,975 (39.9)
1 (25.4)	5-3/4 (146)			31,025 (138.0)	14,875 (66.2)	8,975 (39.9)

- 1 See Section 3.1.8 to convert design strength value to ASD value.
- 2 Hilti KB-TZ2 carbon steel anchors are to be considered ductile steel elements.
- 3 Tensile $\Phi N_{sa} = \phi A_{se,N} f_{uta}$ as noted in ACI 318 Ch. 17.
- 4 Shear values determined by static shear tests with $\Phi V_{sa} < \phi 0.60 A_{se,V} f_{uta}$ as noted in ACI 318 Ch. 17.
- 5 Seismic shear values determined by seismic shear tests with $\Phi V_{sa} \leq \phi 0.60 A_{se,V} f_{uta}$ as noted in ACI 318 Ch. 17. See Section 3.1.8 for additional information on seismic applications.

Figure 2

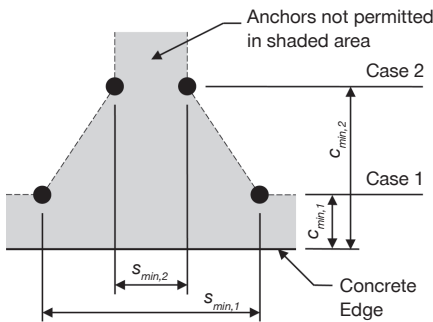

For a specific edge distance, the permitted spacing is calculated as follows:

$$s \geq s_{min,2} + \frac{(s_{min,1} - s_{min,2})}{(c_{min,1} - c_{min,2})} (c - c_{min,2})$$

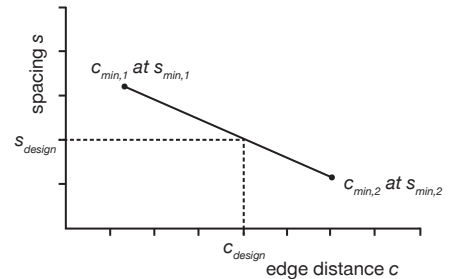

Table 5 — Hilti KB-TZ2 carbon steel installation parameters ¹

Setting information	Symbol	Units	Nominal Anchor diameter (in.)															
			1/4	3/8		1/2			5/8		3/4			1				
Effective embedment	h_{ef}	in. (mm)	1-1/2 (38)	1-1/2 (38)	2 (51)	2-1/2 (64)	1-1/2 (38)	2 (51)	2-1/2 (64)	3 1/4 (83)	2-3/4 (70)	3-1/4 (83)	4 (102)	3-1/4 (83)	3-3/4 (95)	4-3/4 (121)	4 (102)	5-3/4 (146)
Min. member thickness	h_{min}	in. (mm)	3-1/4 (83)	3-1/4 (83)	4 (102)	5 (127)	3-1/2 (89)	4 (102)	5 (127)	5-1/2 (140)	5 (127)	5-1/2 (140)	6 (152)	5-1/2 (140)	6 (152)	8 (203)	8 (203)	10 (254)
Case 1	$c_{min,1}$	in. (mm)	1-1/2 (38)	5 (127)	2-1/2 (64)	2-1/2 (64)	8 (203)	2-3/4 (70)	2-3/4 (70)	2-1/4 (57)	4-1/2 (114)	3-1/2 (89)	2-3/4 (70)	5 (127)	4 (102)	3-1/2 (89)	8 (203)	3 (76)
	for $s_{min,1} \geq$	in. (mm)	1-1/2 (38)	8 (203)	6 (152)	5 (127)	12 (305)	5-1/2 (140)	9-3/4 (248)	5-1/4 (133)	6-1/2 (165)	5-1/2 (140)	7-1/4 (184)	10 (254)	5-3/4 (146)	5-1/2 (140)	8 (203)	6-3/4 (171)
Case 2	$c_{min,2}$	in. (mm)	1-1/2 (38)	8 (203)	3-1/2 (89)	4 (102)	8 (203)	10 (254)	8 (203)	4-3/4 (121)	5-1/2 (140)	7 (178)	4-1/4 (108)	6 (152)	7-1/4 (184)	4-3/4 (121)	8 (203)	3-3/4 (95)
	for $s_{min,2} \geq$	in. (mm)	1-1/2 (38)	5 (127)	2-1/4 (57)	2 (51)	12 (305)	3-1/2 (89)	3 (76)	2 (51)	4-1/2 (114)	2-3/4 (70)	2-1/4 (57)	4-1/2 (114)	3-3/4 (95)	3-3/4 (95)	8 (203)	4-3/4 (121)

¹ Linear interpolation is permitted to establish an edge distance and spacing combination between Case 1 and Case 2. Linear interpolation for a specific edge distance c, where $c_{min,1} < c < c_{min,2}$, will determine the permissible spacings.

Table 6 – Load adjustment factors for Carbon Steel 1/4-in. diameter KB-TZ2 in uncracked concrete ^{1,2}

1/4-in. KB-TZ2 uncracked concrete		Spacing factor in tension f_{AN}	Edge distance factor in tension f_{RN}	Spacing factor in shear ³ f_{AV}			Concrete thickness factor in shear ⁴ f_{HV}
					⊥ Toward edge f_{RV}	∥ To edge f_{RV}	
Effective Embedment h_{ef}	in. (mm)	1-1/2 (38)	1-1/2 (38)	1-1/2 (38)	1-1/2 (38)	1-1/2 (38)	1-1/2 (38)
Nominal Embedment h_{nom}	in. (mm)	1-3/4 (44)	1-3/4 (44)	1-3/4 (44)	1-3/4 (44)	1-3/4 (44)	1-3/4 (44)
Spacing (s) / Edge Distance (c_s) / Concrete Thickness (h) - in. (mm)	1-1/2 (38)	0.67	0.42	0.56	0.23	0.42	n/a
	2 (51)	0.72	0.51	0.58	0.35	0.51	n/a
	2-1/2 (64)	0.78	0.63	0.60	0.49	0.63	n/a
	3 (76)	0.83	0.75	0.63	0.65	0.75	n/a
	3-1/4 (83)	0.86	0.81	0.64	0.73	0.81	0.74
	3-1/2 (89)	0.89	0.88	0.65	0.82	0.88	0.76
	4 (102)	0.94	1.00	0.67	1.00	1.00	0.82
	5 (127)	1.00		0.71			0.91
	6 (152)			0.75			1.00
	7 (178)			0.79			
	8 (203)			0.83			
	9 (229)			0.88			
> 12 (305)			1.00				

3.3.5

Table 7 – Load adjustment factors for Carbon Steel 1/4-in. diameter KB-TZ2 in cracked concrete ^{1,2}

1/4-in. KB-TZ2 cracked concrete		Spacing factor in tension f_{AN}	Edge distance factor in tension f_{RN}	Spacing factor in shear ³ f_{AV}			Concrete thickness factor in shear ⁴ f_{HV}
					⊥ Toward edge f_{RV}	∥ To edge f_{RV}	
Effective Embedment h_e	in. (mm)	1-1/2 (38)	1-1/2 (38)	1-1/2 (38)	1-1/2 (38)	1-1/2 (38)	1-1/2 (38)
Nominal Embedment h_{nom}	in. (mm)	1-3/4 (44)	1-3/4 (44)	1-3/4 (44)	1-3/4 (44)	1-3/4 (44)	1-3/4 (44)
Spacing (s) / Edge Distance (c_s) / Concrete Thickness (h) - in. (mm)	1-1/2 (38)	0.67	0.75	0.57	0.29	0.59	n/a
	2 (51)	0.72	0.91	0.60	0.45	0.91	n/a
	2-1/2 (64)	0.78	1.00	0.62	0.63	1.00	n/a
	3 (76)	0.83		0.65	0.83		n/a
	3-1/4 (83)	0.86		0.66	0.94		0.80
	3-1/2 (89)	0.89		0.67	1.00		0.83
	4 (102)	0.94		0.70			0.89
	5 (127)	1.00		0.75			0.99
	6 (152)			0.80			1.00
	7 (178)			0.84			
	8 (203)			0.89			
	9 (229)			0.94			
> 12 (305)			1.00				

1 Linear interpolation not permitted

2 When combining multiple load adjustment factors (e.g. for a 4 anchor pattern in a corner with thin concrete member) the design can become very conservative.

To optimize the design, use Hilti PROFIS Engineering Design software or perform anchor calculation using design equations from ACI 318 Ch. 17 or CSA A23.3 Annex D.

3 Spacing factor reduction in shear, f_{AV} , is applicable when edge distance $c < 3h_{ef}$. If $c \geq 3h_{ef}$ then $f_{AV} = f_{AN}$.

4 Concrete thickness reduction factor in shear, f_{HV} , is applicable when edge distance $c < 3h_{ef}$. If $c \geq 3h_{ef}$ then $f_{HV} = 1.0$.

Table 8 – Load adjustment factors for Carbon Steel 3/8-in. diameter KB-TZ2 in uncracked concrete^{1,2}

3/8-in. KB-TZ2 uncracked concrete	Spacing factor in tension f_{AN}			Edge distance factor in tension f_{RN}			Spacing factor in shear ³ f_{AV}			Edge distance in shear						Concrete thickness factor in shear ⁴ f_{HV}			
										⊥ Toward edge f_{RV}			∥ To edge f_{RV}						
Effective Embedment h_{ef}	in. (mm)	1-1/2 (38)	2 (51)	2-1/2 (64)	1-1/2 (38)	2 (51)	2-1/2 (64)	1-1/2 (38)	2 (51)	2-1/2 (64)	1-1/2 (38)	2 (51)	2-1/2 (64)	1-1/2 (38)	2 (51)	2-1/2 (64)	1-1/2 (38)	2 (51)	2-1/2 (64)
Nominal Embedment h_{nom}	in. (mm)	1-7/8 (48)	2-1/2 (64)	3 (76)	1-7/8 (48)	2-1/2 (64)	3 (76)	1-7/8 (48)	2-1/2 (64)	3 (76)	1-7/8 (48)	2-1/2 (64)	3 (76)	1-7/8 (48)	2-1/2 (64)	3 (76)	1-7/8 (48)	2-1/2 (64)	3 (76)
Spacing (s) / Edge Distance (c_e) / Concrete Thickness (h) - in. (mm)	2 (51)	n/a	n/a	0.63	n/a	n/a	n/a	n/a	n/a	0.54	n/a	n/a	n/a	n/a	n/a	n/a	n/a	n/a	n/a
	2-1/4 (57)	n/a	0.69	0.65	n/a	n/a	n/a	n/a	0.59	0.55	n/a	n/a	n/a	n/a	n/a	n/a	n/a	n/a	n/a
	2-1/2 (64)	n/a	0.71	0.67	n/a	0.60	0.51	n/a	0.60	0.55	n/a	0.43	0.18	n/a	0.60	0.37	n/a	n/a	n/a
	3 (76)	n/a	0.75	0.70	n/a	0.69	0.58	n/a	0.61	0.56	n/a	0.57	0.24	n/a	0.69	0.48	n/a	n/a	n/a
	3-1/4 (83)	n/a	0.77	0.72	n/a	0.74	0.61	n/a	0.62	0.57	n/a	0.64	0.27	n/a	0.74	0.54	0.66	n/a	n/a
	3-1/2 (89)	n/a	0.79	0.73	n/a	0.80	0.65	n/a	0.63	0.58	n/a	0.72	0.30	n/a	0.80	0.61	0.68	n/a	n/a
	4 (102)	n/a	0.83	0.77	n/a	0.91	0.73	n/a	0.65	0.59	n/a	0.87	0.37	n/a	0.91	0.73	0.73	0.78	n/a
	5 (127)	1.00	0.92	0.83	1.00	1.00	0.91	0.67	0.69	0.61	1.00	1.00	0.52	1.00	1.00	0.91	0.82	0.87	0.66
	6 (152)	1.00	1.00	0.90	1.00		1.00	0.70	0.73	0.63	1.00		0.68	1.00		1.00	0.89	0.96	0.72
	8 (203)	1.00		1.00	1.00			0.77	0.80	0.67	1.00		1.00	1.00			1.00	1.00	0.83
	12 (305)							0.90	0.96	0.76									
18 (457)							1.00	1.00	0.89										
> 24 (610)									1.00										

Table 9 – Load adjustment factors for Carbon Steel 3/8-in. diameter KB-TZ2 in cracked concrete^{1,2}

3/8-in. KB-TZ2 cracked concrete	Spacing factor in tension f_{AN}			Edge distance factor in tension f_{RN}			Spacing factor in shear ³ f_{AV}			Edge distance in shear						Concrete thickness factor in shear ⁴ f_{HV}			
										⊥ Toward edge f_{RV}			∥ To edge f_{RV}						
Effective Embedment h_{ef}	in. (mm)	1-1/2 (38)	2 (51)	2-1/2 (64)	1-1/2 (38)	2 (51)	2-1/2 (64)	1-1/2 (38)	2 (51)	2-1/2 (64)	1-1/2 (38)	2 (51)	2-1/2 (64)	1-1/2 (38)	2 (51)	2-1/2 (64)	1-1/2 (38)	2 (51)	2-1/2 (64)
Nominal Embedment h_{nom}	in. (mm)	1-7/8 (48)	2-1/2 (64)	3 (76)	1-7/8 (48)	2-1/2 (64)	3 (76)	1-7/8 (48)	2-1/2 (64)	3 (76)	1-7/8 (48)	2-1/2 (64)	3 (76)	1-7/8 (48)	2-1/2 (64)	3 (76)	1-7/8 (48)	2-1/2 (64)	3 (76)
Spacing (s) / Edge Distance (c_e) / Concrete Thickness (h) - in. (mm)	2 (51)	n/a	n/a	0.63	n/a	n/a	n/a	n/a	n/a	0.54	n/a	n/a	n/a	n/a	n/a	n/a	n/a	n/a	n/a
	2-1/4 (57)	n/a	0.69	0.65	n/a	n/a	n/a	n/a	0.58	0.55	n/a	n/a	n/a	n/a	n/a	n/a	n/a	n/a	n/a
	2-1/2 (64)	n/a	0.71	0.67	n/a	0.87	0.75	n/a	0.59	0.55	n/a	0.40	0.18	n/a	0.80	0.37	n/a	n/a	n/a
	3 (76)	n/a	0.75	0.70	n/a	1.00	0.85	n/a	0.61	0.56	n/a	0.52	0.24	n/a	1.00	0.48	n/a	n/a	n/a
	3-1/4 (83)	n/a	0.77	0.72	n/a	1.00	0.90	n/a	0.62	0.57	n/a	0.59	0.27	n/a	1.00	0.55	0.78	n/a	n/a
	3-1/2 (89)	n/a	0.79	0.73	n/a	1.00	0.95	n/a	0.63	0.58	n/a	0.66	0.31	n/a	1.00	0.61	0.81	n/a	n/a
	4 (102)	n/a	0.83	0.77	n/a		1.00	n/a	0.64	0.59	n/a	0.81	0.37	n/a		0.75	0.86	0.76	n/a
	5 (127)	1.00	0.92	0.83	1.00			0.73	0.68	0.61	1.00	1.00	0.52	1.00		1.00	0.96	0.85	0.66
	6 (152)	1.00	1.00	0.90	1.00			0.78	0.72	0.63	1.00		0.69	1.00			1.00	0.93	0.72
	8 (203)	1.00		1.00	1.00			0.87	0.79	0.67	1.00		1.00	1.00				1.00	0.83
	12 (305)							1.00	0.93	0.76									
18 (457)								1.00	0.89										
> 24 (610)									1.00										

1 Linear interpolation not permitted
 2 When combining multiple load adjustment factors (e.g. for a 4 anchor pattern in a corner with thin concrete member) the design can become very conservative. To optimize the design, use Hilti PROFIS Engineering Design software or perform anchor calculation using design equations from ACI 318 Ch. 17 or CSA A23.3 Annex D.
 3 Spacing factor reduction in shear, f_{AV} , is applicable when edge distance $c < 3h_{ef}$. If $c \geq 3h_{ef}$, then $f_{AV} = f_{AN}$.
 4 Concrete thickness reduction factor in shear, f_{HV} , is applicable when edge distance $c < 3h_{ef}$. If $c \geq 3h_{ef}$, then $f_{HV} = 1.0$.

■ If a reduction factor value is in a shaded cell, this indicates that this specific edge distance may not be permitted with a certain spacing (or vice versa). Check with Figure 2 and Table 5 to calculate permissible edge distance, spacing and concrete thickness combinations.

Table 12 — Load adjustment factors for Carbon Steel 5/8-in. diameter KB-TZ2 in uncracked concrete ^{1,2}

	5/8-in. KB-TZ2 uncracked concrete	Spacing factor in tension f_{AN}			Edge distance factor in tension f_{RN}			Spacing factor in shear ³ f_{AV}			Edge distance in shear						Concrete thickness factor in shear ⁴ f_{HV}		
		Toward edge f_{RV}		To edge f_{RV}		Toward edge f_{RV}		To edge f_{RV}		Toward edge f_{RV}		To edge f_{RV}		Toward edge f_{RV}		To edge f_{RV}			
Effective Embedment h_{ef}	in. (mm)	2-3/4 (70)	3-1/4 (83)	4 (102)	2-3/4 (70)	3-1/4 (83)	4 (102)	2-3/4 (70)	3-1/4 (83)	4 (102)	2-3/4 (70)	3-1/4 (83)	4 (102)	2-3/4 (70)	3-1/4 (83)	4 (102)	2-3/4 (70)	3-1/4 (83)	4 (102)
Nominal Embedment h_{nom}	in. (mm)	3-1/4 (83)	3-3/4 (95)	4-1/2 (114)	3-1/4 (83)	3-3/4 (95)	4-1/2 (114)	3-1/4 (83)	3-3/4 (95)	4-1/2 (114)	3-1/4 (83)	3-3/4 (95)	4-1/2 (114)	3-1/4 (83)	3-3/4 (95)	4-1/2 (114)	3-1/4 (83)	3-3/4 (95)	4-1/2 (114)
Spacing (s) / Edge Distance (c _e) / Concrete Thickness (h) - in. (mm)	2-1/4 (57)	n/a	0.62	n/a	n/a	n/a	0.38	n/a	0.53	n/a	n/a	n/a	0.10	n/a	n/a	0.20	n/a	n/a	n/a
	2-3/4 (70)	n/a	0.64	0.61	n/a	n/a	0.42	n/a	0.54	0.54	n/a	n/a	0.13	n/a	n/a	0.27	n/a	n/a	n/a
	3 (76)	n/a	0.65	0.63	n/a	0.30	0.44	n/a	0.54	0.55	n/a	0.13	0.15	n/a	0.27	0.30	n/a	n/a	n/a
	3-1/2 (89)	n/a	0.68	0.65	n/a	0.33	0.48	n/a	0.55	0.56	n/a	0.17	0.19	n/a	0.33	0.38	n/a	n/a	n/a
	4 (102)	0.74	0.71	0.67	0.40	0.37	0.51	0.57	0.56	0.56	0.25	0.21	0.23	0.40	0.37	0.47	n/a	n/a	n/a
	4-1/2 (114)	0.77	0.73	0.69	0.45	0.40	0.56	0.58	0.57	0.57	0.30	0.24	0.28	0.45	0.40	0.56	n/a	n/a	n/a
	5 (127)	0.80	0.76	0.71	0.50	0.43	0.60	0.58	0.57	0.58	0.35	0.29	0.33	0.50	0.43	0.60	0.58	n/a	n/a
	5-1/2 (140)	0.83	0.78	0.73	0.55	0.48	0.64	0.59	0.58	0.59	0.41	0.33	0.38	0.55	0.48	0.64	0.61	0.56	n/a
	6 (152)	0.86	0.81	0.75	0.60	0.52	0.69	0.60	0.59	0.59	0.46	0.38	0.43	0.60	0.52	0.69	0.63	0.59	0.62
	6-1/2 (165)	0.89	0.83	0.77	0.65	0.57	0.74	0.61	0.59	0.60	0.52	0.42	0.48	0.65	0.57	0.74	0.66	0.61	0.64
	7 (178)	0.92	0.86	0.79	0.70	0.61	0.80	0.62	0.60	0.61	0.59	0.47	0.54	0.70	0.61	0.80	0.68	0.64	0.67
	7-1/4 (184)	0.94	0.87	0.80	0.73	0.63	0.83	0.62	0.61	0.61	0.62	0.50	0.57	0.73	0.63	0.83	0.70	0.65	0.68
	12 (305)	1.00	1.00	1.00	1.00	1.00	1.00	0.70	0.67	0.69	1.00	1.00	1.00	1.00	1.00	1.00	0.89	0.83	0.87
24 (610)							0.90	0.85	0.88							1.00	1.00	1.00	
> 36 (914)							1.00	1.00	1.00										

Table 13 — Load adjustment factors for Carbon Steel 5/8-in. diameter KB-TZ2 in cracked concrete ^{1,2}

	5/8-in. KB-TZ2 cracked concrete	Spacing factor in tension f_{AN}			Edge distance factor in tension f_{RN}			Spacing factor in shear ³ f_{AV}			Edge distance in shear						Concrete thickness factor in shear ⁴ f_{HV}		
		Toward edge f_{RV}		To edge f_{RV}		Toward edge f_{RV}		To edge f_{RV}		Toward edge f_{RV}		To edge f_{RV}		Toward edge f_{RV}		To edge f_{RV}			
Effective Embedment h_{ef}	in. (mm)	2-3/4 (70)	3-1/4 (83)	4 (102)	2-3/4 (70)	3-1/4 (83)	4 (102)	2-3/4 (70)	3-1/4 (83)	4 (102)	2-3/4 (70)	3-1/4 (83)	4 (102)	2-3/4 (70)	3-1/4 (83)	4 (102)	2-3/4 (70)	3-1/4 (83)	4 (102)
Nominal Embedment h_{nom}	in. (mm)	3-1/4 (83)	3-3/4 (95)	4-1/2 (114)	3-1/4 (83)	3-3/4 (95)	4-1/2 (114)	3-1/4 (83)	3-3/4 (95)	4-1/2 (114)	3-1/4 (83)	3-3/4 (95)	4-1/2 (114)	3-1/4 (83)	3-3/4 (95)	4-1/2 (114)	3-1/4 (83)	3-3/4 (95)	4-1/2 (114)
Spacing (s) / Edge Distance (c _e) / Concrete Thickness (h) - in. (mm)	2-1/4 (57)	n/a	0.62	n/a	n/a	n/a	0.56	n/a	0.54	n/a	n/a	n/a	0.10	n/a	n/a	0.20	n/a	n/a	n/a
	2-3/4 (70)	n/a	0.64	0.61	n/a	n/a	0.61	n/a	0.55	0.54	n/a	n/a	0.13	n/a	n/a	0.27	n/a	n/a	n/a
	3 (76)	n/a	0.65	0.63	n/a	0.71	0.64	n/a	0.55	0.55	n/a	0.16	0.15	n/a	0.32	0.31	n/a	n/a	n/a
	3-1/2 (89)	n/a	0.68	0.65	n/a	0.79	0.69	n/a	0.56	0.56	n/a	0.20	0.19	n/a	0.41	0.39	n/a	n/a	n/a
	4 (102)	0.74	0.71	0.67	0.98	0.86	0.75	0.58	0.57	0.56	0.31	0.25	0.24	0.62	0.50	0.47	n/a	n/a	n/a
	4-1/2 (114)	0.77	0.73	0.69	1.00	0.94	0.81	0.59	0.57	0.57	0.37	0.30	0.28	0.74	0.60	0.56	n/a	n/a	n/a
	5 (127)	0.80	0.76	0.71	1.00	1.00	0.87	0.60	0.58	0.58	0.43	0.35	0.33	0.87	0.70	0.66	0.62	n/a	n/a
	5-1/2 (140)	0.83	0.78	0.73	1.00	1.00	0.93	0.61	0.59	0.59	0.50	0.40	0.38	1.00	0.81	0.76	0.65	0.60	n/a
	6 (152)	0.86	0.81	0.75		1.00	1.00	0.61	0.60	0.60	0.57	0.46	0.43		0.92	0.87	0.68	0.63	0.62
	6-1/2 (165)	0.89	0.83	0.77		1.00		0.62	0.61	0.60	0.64	0.52	0.49		1.00	0.98	0.71	0.66	0.64
	7 (178)	0.92	0.86	0.79		1.00		0.63	0.62	0.61	0.72	0.58	0.55		1.00	1.00	0.73	0.68	0.67
	7-1/4 (184)	0.94	0.87	0.80				0.64	0.62	0.62	0.76	0.61	0.58				0.74	0.69	0.68
	12 (305)	1.00	1.00	1.00				0.73	0.70	0.69	1.00	1.00	1.00				0.96	0.89	0.87
24 (610)							0.96	0.90	0.88							1.00	1.00	1.00	
> 36 (914)							1.00	1.00	1.00										

1 Linear interpolation not permitted

2 When combining multiple load adjustment factors (e.g. for a 4 anchor pattern in a corner with thin concrete member) the design can become very conservative.

To optimize the design, use Hilti PROFIS Engineering Design software or perform anchor calculation using design equations from ACI 318 Ch. 17 or CSA A23.3 Annex D.

3 Spacing factor reduction in shear, f_{AV} , is applicable when edge distance $c < 3h_{ef}$. If $c \geq 3h_{ef}$ then $f_{AV} = f_{AN}$.

4 Concrete thickness reduction factor in shear, f_{HV} , is applicable when edge distance $c < 3h_{ef}$. If $c \geq 3h_{ef}$ then $f_{HV} = 1.0$.

■ If a reduction factor value is in a shaded cell, this indicates that this specific edge distance may not be permitted with a certain spacing (or vice versa). Check with Figure 2 and Table 5 to calculate permissible edge distance, spacing and concrete thickness combinations.

Table 14 – Load adjustment factors for Carbon Steel 3/4-in. diameter KB-TZ2 in uncracked concrete ^{1,2}

3/4-in. KB-TZ2 uncracked concrete	Spacing factor in tension f_{AN}	Spacing factor in tension			Edge distance factor in tension f_{RN}			Spacing factor in shear f_{AV}			Edge distance in shear						Concrete thickness factor in shear f_{HV}		
		3-1/4	3-3/4	4-3/4	3-1/4	3-3/4	4-3/4	3-1/4	3-3/4	4-3/4	⊥ Toward edge f_{RV}	∥ To edge f_{RV}			3-1/4	3-3/4	4-3/4		
Effective Embedment h_{ef}	in. (mm)	3-1/4 (83)	3-3/4 (95)	4-3/4 (121)	3-1/4 (83)	3-3/4 (95)	4-3/4 (121)	3-1/4 (83)	3-3/4 (95)	4-3/4 (121)	3-1/4 (83)	3-3/4 (95)	4-3/4 (121)	3-1/4 (83)	3-3/4 (95)	4-3/4 (121)	3-1/4 (83)	3-3/4 (95)	4-3/4 (121)
Nominal Embedment h_{nom}	in. (mm)	4 (102)	4-1/2 (114)	5-1/2 (140)	4 (102)	4-1/2 (114)	5-1/2 (140)	4 (102)	4-1/2 (114)	5-1/2 (140)	4 (102)	4-1/2 (114)	5-1/2 (140)	4 (102)	4-1/2 (114)	5-1/2 (140)	4 (102)	4-1/2 (114)	5-1/2 (140)
Spacing (s) / Edge Distance (c _y) / Concrete Thickness (h) - in. (mm)	3-1/2 (89)	n/a	n/a	n/a	n/a	n/a	0.50	n/a	n/a	n/a	n/a	n/a	0.16	n/a	n/a	0.32	n/a	n/a	n/a
	3-3/4 (95)	n/a	0.67	0.63	n/a	n/a	0.52	n/a	0.56	0.55	n/a	n/a	0.18	n/a	n/a	0.36	n/a	n/a	n/a
	4 (102)	n/a	0.68	0.64	n/a	0.44	0.54	n/a	0.56	0.56	n/a	0.24	0.20	n/a	0.44	0.40	n/a	n/a	n/a
	4-1/2 (114)	0.73	0.70	0.66	n/a	0.48	0.57	0.56	0.57	0.56	n/a	0.29	0.24	n/a	0.48	0.47	n/a	n/a	n/a
	4-3/4 (121)	0.74	0.71	0.67	n/a	0.49	0.59	0.57	0.58	0.57	n/a	0.31	0.26	n/a	0.49	0.51	n/a	n/a	n/a
	5 (127)	0.76	0.72	0.68	0.42	0.51	0.61	0.57	0.58	0.57	0.27	0.33	0.28	0.42	0.51	0.55	n/a	n/a	n/a
	5-1/2 (140)	0.78	0.74	0.69	0.46	0.55	0.65	0.58	0.59	0.58	0.31	0.39	0.32	0.46	0.55	0.64	0.55	n/a	n/a
	5-3/4 (146)	0.79	0.76	0.70	0.48	0.58	0.67	0.58	0.59	0.58	0.33	0.41	0.34	0.48	0.58	0.67	0.57	n/a	n/a
	6 (152)	0.81	0.77	0.71	0.50	0.60	0.69	0.58	0.60	0.58	0.35	0.44	0.36	0.50	0.60	0.69	0.58	0.62	n/a
	7 (178)	0.86	0.81	0.75	0.58	0.70	0.78	0.60	0.61	0.60	0.45	0.55	0.46	0.58	0.70	0.78	0.62	0.67	n/a
	7-1/4 (184)	0.87	0.82	0.75	0.60	0.73	0.81	0.60	0.62	0.60	0.47	0.58	0.48	0.60	0.73	0.81	0.63	0.68	n/a
	8 (203)	0.91	0.86	0.78	0.67	0.80	0.89	0.61	0.63	0.61	0.54	0.68	0.56	0.67	0.80	0.89	0.67	0.72	0.67
	9 (229)	0.96	0.90	0.82	0.75	0.90	1.00	0.63	0.64	0.63	0.65	0.81	0.67	0.75	0.90	1.00	0.71	0.76	0.71
	10 (254)	1.00	0.94	0.85	0.83	1.00		0.64	0.66	0.64	0.76	0.94	0.78	0.83	1.00		0.75	0.80	0.75
	11 (279)		0.99	0.89	0.92			0.65	0.68	0.66	0.88	1.00	0.90	0.92			0.78	0.84	0.79
	12 (305)		1.00	0.92	1.00			0.67	0.69	0.67	1.00		1.00	1.00			0.82	0.88	0.82
	16 (406)			1.00				0.72	0.76	0.73							0.94	1.00	0.95
	18 (457)							0.75	0.79	0.75							1.00		1.00
	24 (610)							0.83	0.89	0.84									
> 36 (914)							1.00	1.00	1.00										

3.3.5

Table 15 – Load adjustment factors for Carbon Steel 3/4-in. diameter KB-TZ2 in cracked concrete ^{1,2}

3/4-in. KB-TZ2 cracked concrete	Spacing factor in tension f_{AN}	Spacing factor in tension			Edge distance factor in tension f_{RN}			Spacing factor in shear f_{AV}			Edge distance in shear						Concrete thickness factor in shear f_{HV}		
		3-1/4	3-3/4	4-3/4	3-1/4	3-3/4	4-3/4	3-1/4	3-3/4	4-3/4	⊥ Toward edge f_{RV}	∥ To edge f_{RV}			3-1/4	3-3/4	4-3/4		
Effective Embedment h_{ef}	in. (mm)	3-1/4 (83)	3-3/4 (95)	4-3/4 (121)	3-1/4 (83)	3-3/4 (95)	4-3/4 (121)	3-1/4 (83)	3-3/4 (95)	4-3/4 (121)	3-1/4 (83)	3-3/4 (95)	4-3/4 (121)	3-1/4 (83)	3-3/4 (95)	4-3/4 (121)	3-1/4 (83)	3-3/4 (95)	4-3/4 (121)
Nominal Embedment h_{nom}	in. (mm)	4 (102)	4-1/2 (114)	5-1/2 (140)	4 (102)	4-1/2 (114)	5-1/2 (140)	4 (102)	4-1/2 (114)	5-1/2 (140)	4 (102)	4-1/2 (114)	5-1/2 (140)	4 (102)	4-1/2 (114)	5-1/2 (140)	4 (102)	4-1/2 (114)	5-1/2 (140)
Spacing (s) / Edge Distance (c _y) / Concrete Thickness (h) - in. (mm)	3-1/2 (89)	n/a	n/a	n/a	n/a	n/a	0.63	n/a	n/a	n/a	n/a	n/a	0.13	n/a	n/a	0.26	n/a	n/a	n/a
	3-3/4 (95)	n/a	0.67	0.63	n/a	n/a	0.65	n/a	0.56	0.55	n/a	n/a	0.15	n/a	n/a	0.29	n/a	n/a	n/a
	4 (102)	n/a	0.68	0.64	n/a	0.78	0.68	n/a	0.56	0.55	n/a	0.22	0.16	n/a	0.44	0.32	n/a	n/a	n/a
	4-1/2 (114)	0.73	0.70	0.66	n/a	0.85	0.73	0.58	0.57	0.56	n/a	0.26	0.19	n/a	0.52	0.39	n/a	n/a	n/a
	4-3/4 (121)	0.74	0.71	0.67	n/a	0.88	0.75	0.58	0.57	0.56	n/a	0.28	0.21	n/a	0.57	0.42	n/a	n/a	n/a
	5 (127)	0.76	0.72	0.68	1.00	0.91	0.77	0.59	0.58	0.56	0.37	0.31	0.23	0.74	0.61	0.45	n/a	n/a	n/a
	5-1/2 (140)	0.78	0.74	0.69	1.00	0.98	0.83	0.59	0.58	0.57	0.43	0.35	0.26	0.85	0.71	0.52	0.61	n/a	n/a
	5-3/4 (146)	0.79	0.76	0.70	1.00	1.00	0.85	0.60	0.59	0.57	0.46	0.38	0.28	0.91	0.76	0.56	0.63	n/a	n/a
	6 (152)	0.81	0.77	0.71	1.00	1.00	0.88	0.60	0.59	0.57	0.49	0.40	0.30	0.97	0.81	0.59	0.64	0.60	n/a
	7 (178)	0.86	0.81	0.75		1.00	0.99	0.62	0.61	0.59	0.61	0.51	0.37	1.00	1.00	0.75	0.69	0.65	n/a
	7-1/4 (184)	0.87	0.82	0.75			1.00	0.62	0.61	0.59	0.64	0.54	0.39	1.00	1.00	0.79	0.71	0.66	n/a
	8 (203)	0.91	0.86	0.78				0.64	0.62	0.60	0.75	0.62	0.46			0.91	0.74	0.70	0.63
	9 (229)	0.96	0.90	0.82				0.65	0.64	0.61	0.89	0.74	0.54			1.00	0.79	0.74	0.67
	10 (254)	1.00	0.94	0.85				0.67	0.65	0.62	1.00	0.87	0.64			0.83	0.78	0.70	
	11 (279)		0.99	0.89				0.69	0.67	0.64		1.00	0.74			0.87	0.82	0.74	
	12 (305)		1.00	0.92				0.71	0.68	0.65			0.84			0.91	0.85	0.77	
	16 (406)			1.00				0.77	0.74	0.70			1.00			1.00	0.98	0.89	
	18 (457)							0.81	0.77	0.72							1.00	0.94	
	24 (610)							0.91	0.86	0.80									
> 36 (914)							1.00	1.00	0.94										

1 Linear interpolation not permitted

2 When combining multiple load adjustment factors (e.g. for a 4 anchor pattern in a corner with thin concrete member) the design can become very conservative.

To optimize the design, use Hilti PROFIS Engineering Design software or perform anchor calculation using design equations from ACI 318 Ch. 17 or CSA A23.3 Annex D.

3 Spacing factor reduction in shear, f_{AV} , is applicable when edge distance $c < 3h_{ef}$. If $c \geq 3h_{ef}$ then $f_{AV} = f_{AN}$.

4 Concrete thickness reduction factor in shear, f_{HV} , is applicable when edge distance $c < 3h_{ef}$. If $c \geq 3h_{ef}$ then $f_{HV} = 1.0$.

■ If a reduction factor value is in a shaded cell, this indicates that this specific edge distance may not be permitted with a certain spacing (or vice versa). Check with Figure 2 and Table 5 to calculate permissible edge distance, spacing and concrete thickness combinations.

Table 16 – Load adjustment factors for Carbon Steel 1-in. diameter KB-TZ2 in uncracked concrete^{1,2}

1-in. KB-TZ2 uncracked concrete	Spacing factor in tension f_{AN}		Edge distance factor in tension f_{RN}		Spacing factor in shear ³ f_{AV}		Edge distance in shear				Concrete thickness factor in shear ⁴ f_{HV}		
							⊥ Toward edge f_{RV}		∥ To edge f_{RV}				
Effective Embedment h_{ef}	in. (mm)	4 (102)	5-3/4 (146)	4 (102)	5-3/4 (146)	4 (102)	5-3/4 (146)	4 (102)	5-3/4 (146)	4 (102)	5-3/4 (146)	4 (102)	5-3/4 (146)
Nominal Embedment h_{nom}	in. (mm)	4-5/8 (117)	6-3/8 (162)	4-5/8 (117)	6-3/8 (162)	4-5/8 (117)	6-3/8 (162)	4-5/8 (117)	6-3/8 (162)	4-5/8 (117)	6-3/8 (162)	4-5/8 (117)	6-3/8 (162)
Spacing (s) / Edge Distance (c _e) / Concrete Thickness (h) - in. (mm)	3 (76)	n/a	n/a	n/a	0.292	n/a	n/a	n/a	0.081	n/a	0.162	n/a	n/a
	3-3/4 (95)	n/a	n/a	n/a	0.321	n/a	n/a	n/a	0.113	n/a	0.227	n/a	n/a
	4 (102)	n/a	n/a	n/a	0.331	n/a	n/a	n/a	0.125	n/a	0.250	n/a	n/a
	4-1/4 (108)	n/a	n/a	n/a	0.341	n/a	n/a	n/a	0.137	n/a	0.274	n/a	n/a
	4-3/4 (121)	n/a	0.638	n/a	0.362	n/a	0.549	n/a	0.162	n/a	0.324	n/a	n/a
	5 (127)	n/a	0.645	n/a	0.372	n/a	0.552	n/a	0.175	n/a	0.349	n/a	n/a
	6 (152)	n/a	0.674	n/a	0.415	n/a	0.563	n/a	0.230	n/a	0.415	n/a	n/a
	6-3/4 (171)	n/a	0.696	n/a	0.449	n/a	0.570	n/a	0.274	n/a	0.449	n/a	n/a
	8 (203)	0.833	0.732	0.727	0.508	0.621	0.583	0.620	0.354	0.727	0.508	0.696	n/a
	10 (254)	0.917	0.790	0.909	0.625	0.652	0.604	0.867	0.494	0.909	0.625	0.778	0.645
	12 (305)	1.000	0.848	1.000	0.750	0.682	0.625	1.000	0.650	1.000	0.750	0.853	0.707
	18 (457)		1.000		1.000	0.773	0.688		1.000		1.000	1.000	0.866
	24 (610)					0.864	0.750						1.000
36 (914)					1.000	0.875							
> 48 (1219)						1.000							

Table 17 – Load adjustment factors for Carbon Steel 1-in. diameter KB-TZ2 in cracked concrete^{1,2}

1-in. KB-TZ2 cracked concrete	Spacing factor in tension f_{AN}		Edge distance factor in tension f_{RN}		Spacing factor in shear ³ f_{AV}		Edge distance in shear				Concrete thickness factor in shear ⁴ f_{HV}		
							⊥ Toward edge f_{RV}		∥ To edge f_{RV}				
Effective Embedment h_{ef}	in. (mm)	4 (102)	5-3/4 (146)	4 (102)	5-3/4 (146)	4 (102)	5-3/4 (146)	4 (102)	5-3/4 (146)	4 (102)	5-3/4 (146)	4 (102)	5-3/4 (146)
Nominal Embedment h_{nom}	in. (mm)	4-5/8 (117)	6-3/8 (162)	4-5/8 (117)	6-3/8 (162)	4-5/8 (117)	6-3/8 (162)	4-5/8 (117)	6-3/8 (162)	4-5/8 (117)	6-3/8 (162)	4-5/8 (117)	6-3/8 (162)
Spacing (s) / Edge Distance (c _e) / Concrete Thickness (h) - in. (mm)	3 (76)	n/a	n/a	n/a	0.542	n/a	n/a	n/a	0.081	n/a	0.162	n/a	n/a
	3-3/4 (95)	n/a	n/a	n/a	0.596	n/a	n/a	n/a	0.113	n/a	0.226	n/a	n/a
	4 (102)	n/a	n/a	n/a	0.614	n/a	n/a	n/a	0.124	n/a	0.249	n/a	n/a
	4-1/4 (108)	n/a	n/a	n/a	0.633	n/a	n/a	n/a	0.136	n/a	0.272	n/a	n/a
	4-3/4 (121)	n/a	0.638	n/a	0.671	n/a	0.549	n/a	0.161	n/a	0.322	n/a	n/a
	5 (127)	n/a	0.645	n/a	0.690	n/a	0.552	n/a	0.174	n/a	0.348	n/a	n/a
	6 (152)	n/a	0.674	n/a	0.770	n/a	0.562	n/a	0.228	n/a	0.457	n/a	n/a
	6-3/4 (171)	n/a	0.696	n/a	0.833	n/a	0.570	n/a	0.273	n/a	0.545	n/a	n/a
	8 (203)	0.833	0.732	1.000	0.943	0.619	0.583	0.606	0.352	1.000	0.703	0.691	n/a
	10 (254)	0.917	0.790		1.000	0.649	0.604	0.847	0.491		0.983	0.773	0.644
	12 (305)	1.000	0.848			0.679	0.625	1.000	0.646		1.000	0.846	0.706
	18 (457)		1.000			0.769	0.687		1.000			1.000	0.864
	24 (610)					0.858	0.749						0.998
36 (914)					1.000	0.874						1.000	
> 48 (1219)						0.998							

1 Linear interpolation not permitted

2 When combining multiple load adjustment factors (e.g. for a 4 anchor pattern in a corner with thin concrete member) the design can become very conservative.

To optimize the design, use Hilti PROFIS Engineering Design software or perform anchor calculation using design equations from ACI 318 Ch. 17 or CSA A23.3 Annex D.

3 Spacing factor reduction in shear, f_{AV} , is applicable when edge distance $c < 3h_{ef}$. If $c \geq 3h_{ef}$ then $f_{AV} = f_{AN}$.

4 Concrete thickness reduction factor in shear, f_{HV} , is applicable when edge distance $c < 3h_{ef}$. If $c \geq 3h_{ef}$ then $f_{HV} = 1.0$.

■ If a reduction factor value is in a shaded cell, this indicates that this specific edge distance may not be permitted with a certain spacing (or vice versa). Check with Figure 2 and Table 5 to calculate permissible edge distance, spacing and concrete thickness combinations.

Table 18 — Hilti Stainless Steel KB-TZ2 design strength based on concrete failure modes in uncracked concrete per ACI 318 Ch. 17, applicable for both hammer and core drilled installations^{1,2,3,4}

Nominal anchor diameter in.	Effective embedment in. (mm)	Nominal embedment in. (mm)	Tension (lesser of concrete breakout / pullout) - ΦN_n				Shear (lesser of concrete breakout or pryout) - ΦV_n			
			$f'_c = 2,500$ psi (17.2 MPa) lb (kN)	$f'_c = 3,000$ psi (20.7 MPa) lb (kN)	$f'_c = 4,000$ psi (27.6 MPa) lb (kN)	$f'_c = 6,000$ psi (41.1 MPa) lb (kN)	$f'_c = 2,500$ psi (17.2 MPa) lb (kN)	$f'_c = 3,000$ psi (20.7 MPa) lb (kN)	$f'_c = 4,000$ psi (27.6 MPa) lb (kN)	$f'_c = 6,000$ psi (41.1 MPa) lb (kN)
1/4	1-1/2 (38)	1 3/4 (44)	705 (3.1)	760 (3.4)	850 (3.8)	995 (4.4)	1,545 (6.9)	1,690 (7.5)	1,950 (8.7)	2,390 (10.6)
	1-1/2 (38)	1 7/8 (48)	1,435 (6.4)	1,570 (7.0)	1,815 (8.1)	2,220 (9.9)	1,545 (6.9)	1,690 (7.5)	1,950 (8.7)	2,390 (10.6)
3/8	2 (51)	2 1/2 (64)	2,205 (9.8)	2,415 (10.7)	2,790 (12.4)	3,420 (15.2)	2,375 (10.6)	2,605 (11.6)	3,005 (13.4)	3,680 (16.4)
	2-1/2 (64)	3 (76)	2,720 (12.1)	2,910 (12.9)	3,235 (14.4)	3,760 (16.7)	6,640 (29.5)	7,275 (32.4)	8,400 (37.4)	10,290 (45.8)
1/2	2 (51)	2 1/2 (64)	2,195 (9.8)	2,390 (10.6)	2,725 (12.1)	3,285 (14.6)	2,375 (10.6)	2,605 (11.6)	3,005 (13.4)	3,680 (16.4)
	2-1/2 (64)	3 (76)	2,605 (11.6)	2,855 (12.7)	3,295 (14.7)	4,040 (18.0)	6,640 (29.5)	7,275 (32.4)	8,400 (37.4)	10,290 (45.8)
5/8	3-1/4 (83)	3 3/4 (95)	3,575 (15.9)	3,915 (17.4)	4,520 (20.1)	5,540 (24.6)	9,845 (43.8)	10,785 (48.0)	12,450 (55.4)	15,250 (67.8)
	2-3/4 (70)	3 1/4 (83)	2,655 (11.8)	2,910 (12.9)	3,360 (14.9)	4,115 (18.3)	7,660 (34.1)	8,395 (37.3)	9,690 (43.1)	11,870 (52.8)
3/4	3-1/4 (83)	3 3/4 (95)	3,910 (17.4)	4,220 (18.8)	4,765 (21.2)	5,645 (25.1)	9,845 (43.8)	10,785 (48.0)	12,450 (55.4)	15,250 (67.8)
	4 (102)	4 1/2 (114)	5,235 (23.3)	5,700 (25.4)	6,525 (29.0)	7,895 (35.1)	13,440 (59.8)	14,725 (65.5)	17,000 (75.6)	20,820 (92.6)
1	3-1/4 (83)	4 (102)	4,570 (20.3)	5,005 (22.3)	5,780 (25.7)	7,080 (31.5)	9,845 (43.8)	10,785 (48.0)	12,450 (55.4)	15,250 (67.8)
	3-3/4 ⁶ (95)	4 1/2 (114)	6,370 (28.3)	6,980 (31.0)	8,060 (35.9)	9,870 (43.9)	13,725 (61.1)	15,035 (66.9)	17,360 (77.2)	21,265 (94.6)
1	4-3/4 (121)	5 1/2 (140)	8,075 (35.9)	8,845 (39.3)	10,215 (45.4)	12,510 (55.6)	17,390 (77.4)	19,050 (84.7)	22,000 (97.9)	26,945 (119.9)
	4 (102)	4 5/8 (117)	7,020 (31.2)	7,690 (34.2)	8,880 (39.5)	10,875 (48.4)	15,120 (67.3)	16,565 (73.7)	19,125 (85.1)	23,425 (104.2)
1	5-3/4 (146)	6 3/8 (162)	12,100 (53.8)	13,255 (59.0)	15,305 (68.1)	18,745 (83.4)	26,060 (115.9)	28,545 (127.0)	32,965 (146.6)	40,370 (179.6)

3.3.5

Table 19 — Hilti Stainless Steel KB-TZ2 design strength based on concrete failure modes in cracked concrete per ACI 318 Ch. 17, applicable for both hammer and core drilled installations^{1,2,3,4,5}

Nominal anchor diameter in.	Effective embedment in. (mm)	Nominal embedment in. (mm)	Tension (lesser of concrete breakout / pullout) - ΦN_n				Shear (lesser of concrete breakout or pryout) - ΦV_n			
			$f'_c = 2,500$ psi (17.2 MPa) lb (kN)	$f'_c = 3,000$ psi (20.7 MPa) lb (kN)	$f'_c = 4,000$ psi (27.6 MPa) lb (kN)	$f'_c = 6,000$ psi (41.1 MPa) lb (kN)	$f'_c = 2,500$ psi (17.2 MPa) lb (kN)	$f'_c = 3,000$ psi (20.7 MPa) lb (kN)	$f'_c = 4,000$ psi (27.6 MPa) lb (kN)	$f'_c = 6,000$ psi (41.1 MPa) lb (kN)
1/4	1-1/2 (38)	1 3/4 (44)	300 (1.3)	330 (1.5)	380 (1.7)	465 (2.1)	1,095 (4.9)	1,195 (5.3)	1,385 (6.2)	1,695 (7.5)
	1-1/2 (38)	1 7/8 (48)	1,255 (5.6)	1,375 (6.1)	1,585 (7.1)	1,940 (8.6)	1,350 (6.0)	1,480 (6.6)	1,710 (7.6)	2,090 (9.3)
3/8	2 (51)	2 1/2 (64)	1,930 (8.6)	2,115 (9.4)	2,440 (10.9)	2,990 (13.3)	2,080 (9.3)	2,275 (10.1)	2,630 (11.7)	3,220 (14.3)
	2-1/2 (64)	3 (76)	2,185 (9.7)	2,390 (10.6)	2,765 (12.3)	3,385 (15.1)	4,705 (20.9)	5,155 (22.9)	5,950 (26.5)	7,285 (32.4)
1/2	2 (51)	2 1/2 (64)	1,565 (7.0)	1,710 (7.6)	1,975 (8.8)	2,420 (10.8)	1,685 (7.5)	1,845 (8.2)	2,130 (9.5)	2,605 (11.6)
	2-1/2 (64)	3 (76)	2,700 (12.0)	2,955 (13.1)	3,415 (15.2)	4,180 (18.6)	5,810 (25.8)	6,365 (28.3)	7,350 (32.7)	9,000 (40.0)
5/8	3-1/4 ⁸ (83)	3 3/4 (95)	3,235 (14.4)	3,545 (15.8)	4,095 (18.2)	5,015 (22.3)	6,970 (31.0)	7,640 (34.0)	8,820 (39.2)	10,800 (48.0)
	2-3/4 (70)	3 1/4 (83)	3,110 (13.8)	3,410 (15.2)	3,935 (17.5)	4,820 (21.4)	6,705 (29.8)	7,345 (32.7)	8,480 (37.7)	10,385 (46.2)
1	3-1/4 (83)	3 3/4 (95)	4,000 (17.8)	4,380 (19.5)	5,060 (22.5)	6,195 (27.6)	8,615 (38.3)	9,435 (42.0)	10,895 (48.5)	13,345 (59.4)
	4 (102)	4 1/2 (114)	4,420 (19.7)	4,840 (21.5)	5,590 (24.9)	6,845 (30.4)	9,520 (42.3)	10,430 (46.4)	12,040 (53.6)	14,750 (65.6)
3/4	3-1/4 (83)	4 (102)	4,000 (17.8)	4,380 (19.5)	5,060 (22.5)	6,195 (27.6)	8,615 (38.3)	9,435 (42.0)	10,895 (48.5)	13,345 (59.4)
	3-3/4 ⁷ (95)	4 1/2 (114)	4,955 (22.0)	5,430 (24.2)	6,270 (27.9)	7,680 (34.2)	10,675 (47.5)	11,695 (52.0)	13,505 (60.1)	16,540 (73.6)
1	4-3/4 (121)	5 1/2 (140)	5,715 (25.4)	6,260 (27.8)	7,230 (32.2)	8,855 (39.4)	15,220 (67.7)	16,670 (74.2)	19,250 (85.6)	23,575 (104.9)
	4 (102)	4 5/8 (117)	6,240 (27.8)	6,835 (30.4)	7,895 (35.1)	9,665 (43.0)	13,440 (59.8)	14,725 (65.5)	17,000 (75.6)	20,820 (92.6)
1	5-3/4 (146)	6 3/8 (162)	9,410 (41.9)	10,310 (45.9)	11,905 (53.0)	14,580 (64.9)	20,270 (90.2)	22,205 (98.8)	25,640 (114.1)	31,400 (139.7)

1 See Section 3.1.8 to convert design strength value to ASD value.
 2 Linear interpolation between embedment depths and concrete compressive strengths is not permitted.
 3 Apply spacing, edge distance, and concrete thickness factors in tables 22 to 33 as necessary. Compare to the steel values in Table 20. The lesser of the values is to be used for the design.
 4 Tabular values are for normal weight concrete only. For lightweight concrete multiply design strength by λ_s as follows: For sand-lightweight, $\lambda_s = 0.68$; for all-lightweight, $\lambda_s = 0.60$.
 5 Tabular values are for static loads only. Seismic design is not permitted for uncracked concrete. For seismic tension loads, multiply cracked concrete tabular values in tension only by $\alpha_{N,seis} = 0.75$.
 No reduction needed for seismic shear, except for the 3/4 bolts where $\alpha_{V,seis} = 0.81$. See Section 3.1.8 for additional information on seismic applications.
 6 For core drilled installations of 3/4" anchors installed at 3-3/4" effective embedment, apply a reduction factor of 0.89 to the design tension strength.
 7 For core drilled installations of 3/4" anchors installed at 3-3/4" effective embedment, apply a reduction factor of 0.81 to the design tension strength.
 8 For core drilled installations of 1/2" anchors installed at 3-1/4" effective embedment, apply a reduction factor of 0.85 to the design tension strength.

Table 20 — Hilti Stainless Steel KB-TZ2 design strength based on steel failure per ACI 318 Ch. 17^{1,2}

Nominal anchor diameter in.	Effective embedment depth in. (mm)			Tensile ³ ΦN _{sa} lb (kN)	Shear ⁴ ΦV _{sa} lb (kN)	Seismic Shear ⁵ ΦV _{sa} lb (kN)
1/4	1-1/2 (38)			2,190 (9.7)	950 (4.2)	720 (3.2)
3/8	1-1/2 (38)			4,635 (20.6)	3,000 (13.3)	3,000 (13.3)
3/8	2 (51)	2-1/2 (64)	2-1/2 (64)	4,635 (20.6)	3,175 (14.1)	3,175 (14.1)
1/2	2 (51)	2-1/2 (64)	3-1/4 (83)	8,905 (39.6)	5,425 (24.1)	5,425 (24.1)
5/8	2-3/4 (70)	3-1/4 (83)	4 (102)	14,125 (62.8)	8,030 (35.7)	8,030 (35.7)
3/4	3-1/4 (83)	3-3/4 (95)	4-3/4 (121)	18,035 (80.2)	10,765 (47.9)	8,755 (38.9)
1 (25.4)	4 (102)			35,215 (156.6)	14,920 (66.4)	8,755 (38.9)
1 (25.4)	5-3/4 (146)			35,215 (156.6)	20,410 (90.8)	8,755 (38.9)

- See Section 3.1.8 to convert design strength value to ASD value.
- Hilti KB-TZ2 stainless steel anchors are to be considered ductile steel elements.
- Tensile $\Phi N_{sa} = \Phi A_{se,N} f_{uta}$ as noted in ACI 318 Ch. 17.
- Shear values determined by static shear tests with $\Phi V_{sa} < \Phi 0.60 A_{se,V} f_{uta}$ as noted in ACI 318 Ch. 17.
- Seismic shear values determined by seismic shear tests with $\Phi V_{sa} \leq \Phi 0.60 A_{se,V} f_{uta}$ as noted in ACI 318 Ch. 17. See Section 3.1.8 for additional information on seismic applications.

Figure 3

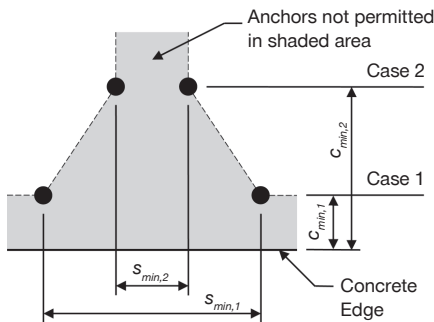

For a specific edge distance, the permitted spacing is calculated as follows:

$$s \geq s_{min,2} + \frac{(s_{min,1} - s_{min,2})}{(c_{min,1} - c_{min,2})} (c - c_{min,2})$$

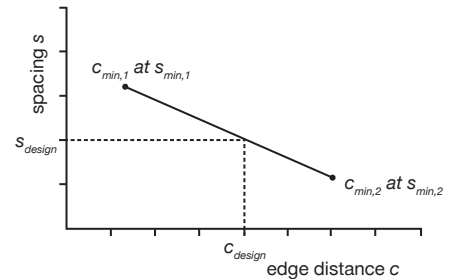

Table 21 — Hilti KB-TZ2 stainless steel installation parameters¹

Setting information	Symbol	Units	Nominal Anchor diameter (in.)														
			1/4	3/8	1/2		5/8		3/4		1						
Effective embedment	h_{ef}	in. (mm)	1-1/2 (38)	1-1/2 (38)	2 (51)	2-1/2 (64)	2 (51)	2-1/2 (64)	3 1/4 (83)	2-3/4 (70)	3-1/4 (83)	4 (102)	3-1/4 (83)	3-3/4 (95)	4-3/4 (121)	4 (102)	5-3/4 (146)
Min. member thickness	h_{min}	in. (mm)	3-1/4 (83)	3-1/4 (83)	4 (102)	5 (127)	4 (102)	5 (127)	5-1/2 (140)	5 (127)	5-1/2 (140)	6 (152)	5-1/2 (140)	6 (152)	8 (203)	8 (203)	10 (254)
Case 1	$c_{min,1}$	in. (mm)	1-1/2 (38)	5 (127)	2-1/2 (64)	2-1/2 (64)	2-3/4 (70)	2-1/2 (64)	2-1/4 (57)	4 (102)	3-1/4 (83)	2-1/4 (57)	5 (127)	4 (102)	3 3/4 (95)	3-3/4 (95)	3 (76)
	for $s_{min,1} \geq$	in. (mm)	1-1/2 (38)	8 (203)	5 (127)	5 (127)	5-1/2 (140)	4-1/2 (114)	5-1/4 (133)	7 (178)	5-1/2 (140)	7 (178)	11 (279)	7-1/2 (191)	5 3/4 (146)	10 (254)	6-3/4 (171)
Case 2	$c_{min,2}$	in. (mm)	1-1/2 (38)	8 (203)	4 (102)	3-1/2 (89)	4-1/8 (105)	4-1/2 (114)	4-1/2 (114)	5-1/2 (140)	4 (102)	4-1/4 (108)	8 (203)	6 (152)	5-1/4 (133)	4-1/4 (108)	3-3/4 (95)
	for $s_{min,2} \geq$	in. (mm)	1-1/2 (38)	5 (127)	2-1/4 (57)	2-1/4 (57)	2-3/4 (70)	2-1/2 (64)	2 (51)	5-1/2 (140)	2-3/4 (70)	3 (76)	5 (127)	4 (102)	4 (102)	5 (127)	4-3/4 (121)

¹ Linear interpolation is permitted to establish an edge distance and spacing combination between Case 1 and Case 2. Linear interpolation for a specific edge distance c , where $c_{min,1} < c < c_{min,2}$, will determine the permissible spacings.

Table 22 – Load adjustment factors for Stainless Steel 1/4-in. diameter KB-TZ2 in uncracked concrete 1,2

1/4-in. KB-TZ2 uncracked concrete	Spacing factor in tension f_{AN}	Edge distance factor in tension f_{RN}	Spacing factor in shear ³ f_{AV}	Edge distance in shear		Conc. thickness factor in shear ⁴ f_{HV}	
				⊥ Toward edge f_{RV}	∥ To edge f_{RV}		
Effective Embedment h_{ef}	in. (mm)	1-1/2 (38)	1-1/2 (38)	1-1/2 (38)	1-1/2 (38)	1-1/2 (38)	
Nominal Embedment h_{nom}	in. (mm)	1-3/4 (44)	1-3/4 (44)	1-3/4 (44)	1-3/4 (44)	1-3/4 (44)	
Spacing (s) / Edge Distance (c _e) / Concrete Thickness (h) - in. (mm)	1-1/2 (38)	0.67	0.42	0.56	0.23	0.42	n/a
	2 (51)	0.72	0.51	0.58	0.35	0.51	n/a
	2-1/2 (64)	0.78	0.63	0.60	0.49	0.63	n/a
	3 (76)	0.83	0.75	0.63	0.65	0.75	n/a
	3-1/4 (83)	0.86	0.81	0.64	0.73	0.81	0.74
	3-1/2 (89)	0.89	0.88	0.65	0.82	0.88	0.76
	4 (102)	0.94	1.00	0.67	1.00	1.00	0.82
	5 (127)	1.00		0.71			0.91
	6 (152)			0.75			1.00
	7 (178)			0.79			
	8 (203)			0.83			
	9 (229)			0.88			
> 12 (305)			1.00				

3.3.5

Table 23 – Load adjustment factors for Stainless Steel 1/4-in. diameter KB-TZ2 in cracked concrete 1,2

1/4-in. KB-TZ2 cracked concrete	Spacing factor in tension f_{AN}	Edge distance factor in tension f_{RN}	Spacing factor in shear ³ f_{AV}	Edge distance in shear		Conc. thickness factor in shear ⁴ f_{HV}	
				⊥ Toward edge f_{RV}	∥ To edge f_{RV}		
Effective Embedment h_{ef}	in. (mm)	1-1/2 (38)	1-1/2 (38)	1-1/2 (38)	1-1/2 (38)	1-1/2 (38)	
Nominal Embedment h_{nom}	in. (mm)	1-3/4 (44)	1-3/4 (44)	1-3/4 (44)	1-3/4 (44)	1-3/4 (44)	
Spacing (s) / Edge Distance (c _e) / Concrete Thickness (h) - in. (mm)	1-1/2 (38)	0.67	0.75	0.57	0.29	0.59	n/a
	2 (51)	0.72	0.91	0.60	0.45	0.91	n/a
	2-1/2 (64)	0.78	1.00	0.62	0.63	1.00	n/a
	3 (76)	0.83		0.65	0.83		n/a
	3-1/4 (83)	0.86		0.66	0.94		0.80
	3-1/2 (89)	0.89		0.67	1.00		0.83
	4 (102)	0.94		0.70			0.89
	5 (127)	1.00		0.75			0.99
	6 (152)			0.80			1.00
	7 (178)			0.84			
	8 (203)			0.89			
	9 (229)			0.94			
> 12 (305)			1.00				

1 Linear interpolation not permitted

2 When combining multiple load adjustment factors (e.g. for a 4 anchor pattern in a corner with thin concrete member) the design can become very conservative.

To optimize the design, use Hilti PROFIS Engineering Design software or perform anchor calculation using design equations from ACI 318 Ch. 17 or CSA A23.3 Annex D.

3 Spacing factor reduction in shear, f_{AV} , is applicable when edge distance $c < 3h_{ef}$. If $c \geq 3h_{ef}$ then $f_{AV} = f_{AN}$.

4 Concrete thickness reduction factor in shear, f_{HV} , is applicable when edge distance $c < 3h_{ef}$. If $c \geq 3h_{ef}$ then $f_{HV} = 1.0$.

Table 24 – Load adjustment factors for Stainless Steel 3/8-in. diameter KB-TZ2 in uncracked concrete^{1,4}

3/8-in. KB-TZ2 uncracked concrete		Spacing factor in tension f_{AN}			Edge distance factor in tension f_{RN}			Spacing factor in shear ³ f_{AV}			Edge distance in shear						Concrete thickness factor in shear ⁴ f_{HV}			
											⊥ Toward edge f_{RV}			∥ To edge f_{RV}						
Effective Embedment h_{ef}	in. (mm)	1-1/2 (38)	2 (51)	2-1/2 (64)	1-1/2 (38)	2 (51)	2-1/2 (64)	1-1/2 (38)	2 (51)	2-1/2 (64)	1-1/2 (38)	2 (51)	2-1/2 (64)	1-1/2 (38)	2 (51)	2-1/2 (64)	1-1/2 (38)	2 (51)	2-1/2 (64)	
Nominal Embedment h_{nom}	in. (mm)	1-7/8 (48)	2-1/2 (64)	3 (76)	1-7/8 (48)	2-1/2 (64)	3 (76)	1-7/8 (48)	2-1/2 (64)	3 (76)	1-7/8 (48)	2-1/2 (64)	3 (76)	1-7/8 (48)	2-1/2 (64)	3 (76)	1-7/8 (48)	2-1/2 (64)	3 (76)	
Spacing (s) / Edge Distance (c_e) / Concrete Thickness (h) - in. (mm)	2-1/4 (57)	n/a	0.69	0.65	n/a	n/a	n/a	n/a	0.57	0.55	n/a	n/a	n/a	n/a	n/a	n/a	n/a	n/a	n/a	
	2-1/2 (64)	n/a	0.71	0.67	n/a	0.48	0.68	n/a	0.58	0.55	n/a	0.31	0.18	n/a	0.48	0.37	n/a	n/a	n/a	
	3 (76)	n/a	0.75	0.70	n/a	0.55	0.77	n/a	0.59	0.56	n/a	0.40	0.24	n/a	0.55	0.48	n/a	n/a	n/a	
	3-1/4 (83)	n/a	0.77	0.72	n/a	0.59	0.81	n/a	0.60	0.57	n/a	0.45	0.27	n/a	0.59	0.54	0.69	n/a	n/a	
	3-1/2 (89)	n/a	0.79	0.73	n/a	0.64	0.86	n/a	0.61	0.58	n/a	0.51	0.30	n/a	0.64	0.61	0.72	n/a	n/a	
	4 (102)	n/a	0.83	0.77	n/a	0.73	0.97	n/a	0.62	0.59	n/a	0.62	0.37	n/a	0.73	0.74	0.77	0.70	n/a	
	5 (127)	1.00	0.92	0.83	1.00	0.91	1.00	0.69	0.65	0.61	1.00	0.87	0.52	1.00	0.91	1.00	0.86	0.78	0.66	
	6 (152)	1.00	1.00	0.90	1.00	1.00		0.72	0.68	0.63	1.00	1.00	0.68	1.00	1.00		0.94	0.85	0.72	
	8 (203)	1.00		1.00	1.00			0.80	0.74	0.67	1.00		1.00	1.00			1.00	0.98	0.83	
	10 (254)							0.87	0.80	0.71								1.00	0.93	
	12 (305)							0.94	0.86	0.76										1.00
	18 (457)							1.00	1.00	0.89										
> 24 (610)									1.00											

Table 25 – Load adjustment factors for Stainless Steel 3/8-in. diameter KB-TZ2 in cracked concrete^{1,4}

3/8-in. KB-TZ2 cracked concrete		Spacing factor in tension f_{AN}			Edge distance factor in tension f_{RN}			Spacing factor in shear ³ f_{AV}			Edge distance in shear						Concrete thickness factor in shear ⁴ f_{HV}			
											⊥ Toward edge f_{RV}			∥ To edge f_{RV}						
Effective Embedment h_{ef}	in. (mm)	1-1/2 (38)	2 (51)	2-1/2 (64)	1-1/2 (38)	2 (51)	2-1/2 (64)	1-1/2 (38)	2 (51)	2-1/2 (64)	1-1/2 (38)	2 (51)	2-1/2 (64)	1-1/2 (38)	2 (51)	2-1/2 (64)	1-1/2 (38)	2 (51)	2-1/2 (64)	
Nominal Embedment h_{nom}	in. (mm)	1-7/8 (48)	2-1/2 (64)	3 (76)	1-7/8 (48)	2-1/2 (64)	3 (76)	1-7/8 (48)	2-1/2 (64)	3 (76)	1-7/8 (48)	2-1/2 (64)	3 (76)	1-7/8 (48)	2-1/2 (64)	3 (76)	1-7/8 (48)	2-1/2 (64)	3 (76)	
Spacing (s) / Edge Distance (c_e) / Concrete Thickness (h) - in. (mm)	2-1/4 (57)	n/a	0.69	0.65	n/a	n/a	n/a	n/a	0.58	0.55	n/a	n/a	n/a	n/a	n/a	n/a	n/a	n/a	n/a	
	2-1/2 (64)	n/a	0.71	0.67	n/a	0.87	0.75	n/a	0.59	0.55	n/a	0.40	0.18	n/a	0.80	0.37	n/a	n/a	n/a	
	3 (76)	n/a	0.75	0.70	n/a	1.00	0.85	n/a	0.61	0.56	n/a	0.52	0.24	n/a	1.00	0.48	n/a	n/a	n/a	
	3-1/4 (83)	n/a	0.77	0.72	n/a	1.00	0.90	n/a	0.62	0.57	n/a	0.59	0.27	n/a	1.00	0.55	0.78	n/a	n/a	
	3-1/2 (89)	n/a	0.79	0.73	n/a	1.00	0.95	n/a	0.63	0.58	n/a	0.66	0.31	n/a	1.00	0.61	0.81	n/a	n/a	
	4 (102)	n/a	0.83	0.77	n/a	1.00	1.00	n/a	0.64	0.59	n/a	0.81	0.37	n/a	1.00	0.75	0.86	0.76	n/a	
	5 (127)	1.00	0.92	0.83	1.00			0.73	0.68	0.61	1.00	1.00	0.52	1.00		1.00	0.96	0.85	0.66	
	6 (152)	1.00	1.00	0.90	1.00			0.78	0.72	0.63	1.00		0.69	1.00			1.00	0.93	0.72	
	8 (203)	1.00		1.00	1.00			0.87	0.79	0.67	1.00		1.00	1.00			1.00	0.83		
	10 (254)							0.96	0.86	0.72									0.93	
	12 (305)							1.00	0.93	0.76										1.00
	18 (457)								1.00	0.89										
> 24 (610)									1.00											

1 Linear interpolation not permitted

2 When combining multiple load adjustment factors (e.g. for a 4 anchor pattern in a corner with thin concrete member) the design can become very conservative.

To optimize the design, use Hilti PROFIS Engineering Design software or perform anchor calculation using design equations from ACI 318 Ch. 17 or CSA A23.3 Annex D.

3 Spacing factor reduction in shear, f_{AV} , is applicable when edge distance $c < 3h_{ef}$. If $c \geq 3h_{ef}$ then $f_{AV} = f_{AN}$.

4 Concrete thickness reduction factor in shear, f_{HV} , is applicable when edge distance $c < 3h_{ef}$. If $c \geq 3h_{ef}$ then $f_{HV} = 1.0$.

■ If a reduction factor value is in a shaded cell, this indicates that this specific edge distance may not be permitted with a certain spacing (or vice versa). Check with Figure 3 and Table 21 to calculate permissible edge distance, spacing and concrete thickness combinations.

Table 26 – Load adjustment factors for Stainless Steel 1/2-in. diameter KB-TZ2 in uncracked concrete ^{1,2}

1/2-in. KB-TZ2 uncracked concrete		Spacing factor in tension f_{AN}			Edge distance factor in tension f_{RN}			Spacing factor in shear f_{AV}			Edge distance in shear						Concrete thickness factor in shear f_{HV}		
											⊥ Toward edge f_{RV}			∥ To edge f_{RV}					
Effective Embedment h_{ef}	in. (mm)	2 (51)	2-1/2 (64)	3-1/4 (83)	2 (51)	2-1/2 (64)	3-1/4 (83)	2 (51)	2-1/2 (64)	3-1/4 (83)	2 (51)	2-1/2 (64)	3-1/4 (83)	2 (51)	2-1/2 (64)	3-1/4 (83)	2 (51)	2-1/2 (64)	3-1/4 (83)
Nominal Embedment h_{nom}	in. (mm)	2-1/2 (64)	3 (76)	3-3/4 (95)	2-1/2 (64)	3 (76)	3-3/4 (95)	2-1/2 (64)	3 (76)	3-3/4 (95)	2-1/2 (64)	3 (76)	3-3/4 (95)	2-1/2 (64)	3 (76)	3-3/4 (95)	2-1/2 (64)	3 (76)	3-3/4 (95)
Spacing (s) / Edge Distance (c _g) / Concrete Thickness (h) - in. (mm)	2 (51)	n/a	n/a	0.60	n/a	n/a	n/a	n/a	n/a	0.54	n/a	n/a	n/a	n/a	n/a	n/a	n/a	n/a	n/a
	2-1/4 (57)	n/a	n/a	0.62	n/a	n/a	0.40	n/a	n/a	0.54	n/a	n/a	0.12	n/a	n/a	0.24	n/a	n/a	n/a
	2-1/2 (64)	n/a	n/a	0.63	n/a	0.45	0.42	n/a	n/a	0.55	n/a	0.20	0.14	n/a	0.40	0.28	n/a	n/a	n/a
	2-3/4 (70)	n/a	0.68	0.64	0.51	0.48	0.44	n/a	0.56	0.55	0.35	0.23	0.16	0.51	0.46	0.33	n/a	n/a	n/a
	3 (76)	0.75	0.70	0.65	0.55	0.51	0.46	0.59	0.57	0.55	0.40	0.26	0.19	0.55	0.51	0.37	n/a	n/a	n/a
	4 (102)	0.83	0.77	0.71	0.73	0.64	0.56	0.62	0.59	0.57	0.62	0.40	0.29	0.73	0.64	0.56	0.70	n/a	n/a
	4-1/8 (105)	0.84	0.78	0.71	0.75	0.66	0.57	0.63	0.59	0.57	0.65	0.42	0.30	0.75	0.66	0.57	0.71	n/a	n/a
	4-1/2 (114)	0.88	0.80	0.73	0.82	0.72	0.61	0.64	0.60	0.58	0.74	0.48	0.34	0.82	0.72	0.61	0.74	n/a	n/a
	4-3/4 (121)	0.90	0.82	0.74	0.86	0.76	0.64	0.64	0.61	0.59	0.80	0.52	0.37	0.86	0.76	0.64	0.76	n/a	n/a
	5 (127)	0.92	0.83	0.76	0.91	0.80	0.67	0.65	0.61	0.59	0.87	0.56	0.40	0.91	0.80	0.67	0.78	0.67	n/a
	5-1/4 (133)	0.94	0.85	0.77	0.95	0.84	0.70	0.66	0.62	0.60	0.93	0.61	0.43	0.95	0.84	0.70	0.80	0.69	n/a
	5-1/2 (140)	0.96	0.87	0.78	1.00	0.88	0.73	0.67	0.63	0.60	1.00	0.65	0.46	1.00	0.88	0.73	0.82	0.71	0.63
	6 (152)	1.00	0.90	0.81		0.96	0.80	0.68	0.64	0.61		0.74	0.53		0.96	0.80	0.85	0.74	0.66
	8 (203)		1.00	0.91		1.00	1.00	0.74	0.68	0.64		1.00	0.81		1.00	1.00	0.98	0.85	0.76
	12 (305)			1.00				0.86	0.77	0.72			1.00				1.00	1.00	0.93
	18 (457)							1.00	0.91	0.83									1.00
	24 (610)								1.00	0.93									
> 30 (762)									1.00										

3.3.5

Table 27 – Load adjustment factors for Stainless Steel 1/2-in. diameter KB-TZ2 in cracked concrete ^{1,2}

1/2-in. KB-TZ2 cracked concrete		Spacing factor in tension f_{AN}			Edge distance factor in tension f_{RN}			Spacing factor in shear f_{AV}			Edge distance in shear						Concrete thickness factor in shear f_{HV}			
											⊥ Toward edge f_{RV}			∥ To edge f_{RV}						
Effective Embedment h_{ef}	in. (mm)	2 (51)	2-1/2 (64)	3-1/4 (83)	2 (51)	2-1/2 (64)	3-1/4 (83)	2 (51)	2-1/2 (64)	3-1/4 (83)	2 (51)	2-1/2 (64)	3-1/4 (83)	2 (51)	2-1/2 (64)	3-1/4 (83)	2 (51)	2-1/2 (64)	3-1/4 (83)	
Nominal Embedment h_{nom}	in. (mm)	2-1/2 (64)	3 (76)	3-3/4 (95)	2-1/2 (64)	3 (76)	3-3/4 (95)	2-1/2 (64)	3 (76)	3-3/4 (95)	2-1/2 (64)	3 (76)	3-3/4 (95)	2-1/2 (64)	3 (76)	3-3/4 (95)	2-1/2 (64)	3 (76)	3-3/4 (95)	
Spacing (s) / Edge Distance (c _g) / Concrete Thickness (h) - in. (mm)	2 (51)	n/a	n/a	0.60	n/a	n/a	n/a	n/a	n/a	0.54	n/a	n/a	n/a	n/a	n/a	n/a	n/a	n/a	n/a	
	2-1/4 (57)	n/a	n/a	0.62	n/a	n/a	0.61	n/a	n/a	0.54	n/a	n/a	0.12	n/a	n/a	0.24	n/a	n/a	n/a	
	2-1/2 (64)	n/a	n/a	0.63	n/a	0.75	0.65	n/a	n/a	0.55	n/a	0.16	0.14	n/a	0.33	0.29	n/a	n/a	n/a	
	2-3/4 (70)	n/a	0.68	0.64	0.93	0.80	0.68	n/a	0.55	0.55	0.62	0.19	0.16	0.93	0.38	0.33	n/a	n/a	n/a	
	3 (76)	0.75	0.70	0.65	1.00	0.85	0.71	0.63	0.56	0.55	0.71	0.21	0.19	1.00	0.43	0.38	n/a	n/a	n/a	
	4 (102)	0.83	0.77	0.71	1.00	1.00	0.86	0.68	0.58	0.57	1.00	0.33	0.29	1.00	0.66	0.58	0.84	n/a	n/a	
	4-1/8 (105)	0.84	0.78	0.71	1.00	1.00	0.88	0.68	0.58	0.58	1.00	0.34	0.30	1.00	0.69	0.61	0.85	n/a	n/a	
	4-1/2 (114)	0.88	0.80	0.73		1.00	0.94	0.70	0.59	0.58		0.39	0.34		0.79	0.69	0.89	n/a	n/a	
	4-3/4 (121)	0.90	0.82	0.74			0.98	0.71	0.59	0.59		0.43	0.37		0.85	0.75	0.91	n/a	n/a	
	5 (127)	0.92	0.83	0.76			1.00	0.72	0.60	0.59		0.46	0.40		0.92	0.81	0.94	0.63	n/a	
	5-1/4 (133)	0.94	0.85	0.77				0.73	0.60	0.60		0.49	0.43		0.99	0.87	0.96	0.65	n/a	
	5-1/2 (140)	0.96	0.87	0.78					0.74	0.61	0.60	0.53	0.47		1.00	0.93	0.98	0.66	0.63	
	6 (152)	1.00	0.90	0.81					0.76	0.62	0.61		0.60	0.53			1.00	1.00	0.69	0.66
	8 (203)		1.00	0.91					0.85	0.66	0.65		0.93	0.82					0.80	0.76
	12 (305)			1.00					1.00	0.74	0.72		1.00	1.00					0.98	0.94
	18 (457)									0.86	0.83								1.00	1.00
	24 (610)									0.98	0.94									
> 30 (762)									1.00	1.00										

1 Linear interpolation not permitted

2 When combining multiple load adjustment factors (e.g. for a 4 anchor pattern in a corner with thin concrete member) the design can become very conservative.

To optimize the design, use Hilti PROFIS Engineering Design software or perform anchor calculation using design equations from ACI 318 Ch. 17 or CSA A23.3 Annex D.

3 Spacing factor reduction in shear, f_{AV} , is applicable when edge distance $c < 3h_{ef}$. If $c \geq 3h_{ef}$ then $f_{AV} = f_{AN}$.

4 Concrete thickness reduction factor in shear, f_{HV} , is applicable when edge distance $c < 3h_{ef}$. If $c \geq 3h_{ef}$ then $f_{HV} = 1.0$.

■ If a reduction factor value is in a shaded cell, this indicates that this specific edge distance may not be permitted with a certain spacing (or vice versa). Check with Figure 3 and Table 21 to calculate permissible edge distance, spacing and concrete thickness combinations.

Table 28 – Load adjustment factors for Stainless Steel 5/8-in. diameter KB-TZ2 in uncracked concrete^{1,2}

5/8-in. KB-TZ2 uncracked concrete	Spacing factor in tension f_{AN}			Edge distance factor in tension f_{RN}			Spacing factor in shear ³ f_{AV}			Edge distance in shear						Concrete thickness factor in shear ⁴ f_{HV}			
										⊥ Toward edge f_{RV}			∥ To edge f_{RV}						
Effective Embedment h_{ef}	in. (mm)	2-3/4 (70)	3-1/4 (83)	4 (102)	2-3/4 (70)	3-1/4 (83)	4 (102)	2-3/4 (70)	3-1/4 (83)	4 (102)	2-3/4 (70)	3-1/4 (83)	4 (102)	2-3/4 (70)	3-1/4 (83)	4 (102)	2-3/4 (70)	3-1/4 (83)	4 (102)
Nominal Embedment h_{nom}	in. (mm)	3-1/4 (83)	3-3/4 (95)	4-1/2 (114)	3-1/4 (83)	3-3/4 (95)	4-1/2 (114)	3-1/4 (83)	3-3/4 (95)	4-1/2 (114)	3-1/4 (83)	3-3/4 (95)	4-1/2 (114)	3-1/4 (83)	3-3/4 (95)	4-1/2 (114)	3-1/4 (83)	3-3/4 (95)	4-1/2 (114)
Spacing (s) / Edge Distance (c_e) / Concrete Thickness (h) - in. (mm)	2-1/4 (57)	n/a	n/a	n/a	n/a	n/a	0.38	n/a	n/a	n/a	n/a	n/a	0.10	n/a	n/a	0.20	n/a	n/a	n/a
	2-3/4 (70)	n/a	0.64	n/a	n/a	n/a	0.42	n/a	0.55	n/a	n/a	n/a	0.13	n/a	n/a	0.27	n/a	n/a	n/a
	3 (76)	n/a	0.65	0.63	n/a	n/a	0.44	n/a	0.56	0.55	n/a	n/a	0.15	n/a	n/a	0.30	n/a	n/a	n/a
	3-1/4 (83)	n/a	0.67	0.64	n/a	0.56	0.46	n/a	0.56	0.55	n/a	0.22	0.17	n/a	0.45	0.34	n/a	n/a	n/a
	4 (102)	n/a	0.71	0.67	0.40	0.65	0.51	n/a	0.58	0.56	0.25	0.31	0.23	0.40	0.61	0.47	n/a	n/a	n/a
	4-1/4 (108)	n/a	0.72	0.68	0.43	0.67	0.53	n/a	0.58	0.57	0.28	0.34	0.26	0.43	0.67	0.51	n/a	n/a	n/a
	5 (127)	n/a	0.76	0.71	0.50	0.77	0.60	n/a	0.59	0.58	0.35	0.43	0.33	0.50	0.77	0.60	0.58	n/a	n/a
	5-1/2 (140)	0.83	0.78	0.73	0.55	0.85	0.64	0.59	0.60	0.59	0.41	0.49	0.38	0.55	0.85	0.64	0.61	0.65	n/a
	6 (152)	0.86	0.81	0.75	0.60	0.92	0.69	0.60	0.61	0.59	0.46	0.56	0.43	0.60	0.92	0.69	0.63	0.67	0.62
	7 (178)	0.92	0.86	0.79	0.70	1.00	0.80	0.62	0.63	0.61	0.59	0.71	0.54	0.70	1.00	0.80	0.68	0.73	0.67
	8 (203)	0.98	0.91	0.83	0.80		0.91	0.63	0.65	0.63	0.72	0.87	0.66	0.80		0.91	0.68	0.78	0.71
	10 (254)	1.00	1.00	0.92	1.00		1.00	0.67	0.69	0.66	1.00	1.00	0.92	1.00		1.00	0.82	0.87	0.80
	12 (305)			1.00				0.70	0.73	0.69			1.00				0.89	0.95	0.87
	24 (610)							0.90	0.95	0.88							1.00	1.00	1.00
> 36 (914)							1.00	1.00	1.00										

Table 29 – Load adjustment factors for Stainless Steel 5/8-in. diameter KB-TZ2 in cracked concrete^{1,2}

5/8-in. KB-TZ2 cracked concrete	Spacing factor in tension f_{AN}			Edge distance factor in tension f_{RN}			Spacing factor in shear ³ f_{AV}			Edge distance in shear						Concrete thickness factor in shear ⁴ f_{HV}			
										⊥ Toward edge f_{RV}			∥ To edge f_{RV}						
Effective Embedment h_{ef}	in. (mm)	2-3/4 (70)	3-1/4 (83)	4 (102)	2-3/4 (70)	3-1/4 (83)	4 (102)	2-3/4 (70)	3-1/4 (83)	4 (102)	2-3/4 (70)	3-1/4 (83)	4 (102)	2-3/4 (70)	3-1/4 (83)	4 (102)	2-3/4 (70)	3-1/4 (83)	4 (102)
Nominal Embedment h_{nom}	in. (mm)	3-1/4 (83)	3-3/4 (95)	4-1/2 (114)	3-1/4 (83)	3-3/4 (95)	4-1/2 (114)	3-1/4 (83)	3-3/4 (95)	4-1/2 (114)	3-1/4 (83)	3-3/4 (95)	4-1/2 (114)	3-1/4 (83)	3-3/4 (95)	4-1/2 (114)	3-1/4 (83)	3-3/4 (95)	4-1/2 (114)
Spacing (s) / Edge Distance (c_e) / Concrete Thickness (h) - in. (mm)	2-1/4 (57)	n/a	n/a	n/a	n/a	n/a	0.56	n/a	n/a	n/a	n/a	n/a	0.10	n/a	n/a	0.20	n/a	n/a	n/a
	2-3/4 (70)	n/a	0.64	n/a	n/a	n/a	0.61	n/a	0.55	n/a	n/a	n/a	0.13	n/a	n/a	0.27	n/a	n/a	n/a
	3 (76)	n/a	0.65	0.63	n/a	n/a	0.64	n/a	0.55	0.55	n/a	n/a	0.15	n/a	n/a	0.31	n/a	n/a	n/a
	3-1/4 (83)	n/a	0.67	0.64	n/a	0.75	0.66	n/a	0.55	0.55	n/a	0.18	0.17	n/a	0.37	0.35	n/a	n/a	n/a
	4 (102)	n/a	0.71	0.67	0.98	0.86	0.75	n/a	0.57	0.56	0.31	0.25	0.24	0.62	0.50	0.47	n/a	n/a	n/a
	4-1/4 (108)	n/a	0.72	0.68	1.00	0.90	0.78	n/a	0.57	0.57	0.34	0.27	0.26	0.68	0.55	0.52	n/a	n/a	n/a
	5 (127)	n/a	0.76	0.71	1.00	1.00	0.87	n/a	0.58	0.58	0.43	0.35	0.33	0.87	0.70	0.66	0.62	n/a	n/a
	5-1/2 (140)	0.83	0.78	0.73	1.00		0.93	0.61	0.59	0.59	0.50	0.40	0.38	1.00	0.81	0.76	0.65	0.60	n/a
	6 (152)	0.86	0.81	0.75			1.00	0.61	0.60	0.60	0.57	0.46	0.43		0.92	0.87	0.68	0.63	0.62
	7 (178)	0.92	0.86	0.79				0.63	0.62	0.61	0.72	0.58	0.55		1.00	1.00	0.73	0.68	0.67
	8 (203)	0.98	0.91	0.83				0.65	0.63	0.63	0.88	0.71	0.67				0.78	0.73	0.71
	10 (254)	1.00	1.00	0.92				0.69	0.67	0.66	1.00	0.99	0.93				0.87	0.81	0.80
	12 (305)			1.00				0.73	0.70	0.69		1.00	1.00				0.96	0.89	0.87
	24 (610)							0.96	0.90	0.88							1.00	1.00	1.00
> 36 (914)							1.00	1.00	1.00										

1 Linear interpolation not permitted

2 When combining multiple load adjustment factors (e.g. for a 4 anchor pattern in a corner with thin concrete member) the design can become very conservative.

To optimize the design, use Hilti PROFIS Engineering Design software or perform anchor calculation using design equations from ACI 318 Ch. 17 or CSA A23.3 Annex D.

3 Spacing factor reduction in shear, f_{AV} , is applicable when edge distance $c < 3h_{ef}$. If $c \geq 3h_{ef}$ then $f_{AV} = f_{AN}$.

4 Concrete thickness reduction factor in shear, f_{HV} , is applicable when edge distance $c < 3h_{ef}$. If $c \geq 3h_{ef}$ then $f_{HV} = 1.0$.

■ If a reduction factor value is in a shaded cell, this indicates that this specific edge distance may not be permitted with a certain spacing (or vice versa). Check with Figure 3 and Table 21 to calculate permissible edge distance, spacing and concrete thickness combinations.

Table 30 – Load adjustment factors for Stainless Steel 3/4-in. diameter KB-TZ2 in uncracked concrete^{1,2}

3/4-in. KB-TZ2 uncracked concrete		Spacing factor in tension f_{AN}			Edge distance factor in tension f_{RN}			Spacing factor in shear ³ f_{AV}			Edge distance in shear						Concrete thickness factor in shear ⁴ f_{HV}		
											⊥ Toward edge f_{RV}			∥ To edge f_{RV}					
Effective Embedment h_{ef}	in. (mm)	3-1/4 (83)	3-3/4 (95)	4-3/4 (121)	3-1/4 (83)	3-3/4 (95)	4-3/4 (121)	3-1/4 (83)	3-3/4 (95)	4-3/4 (121)	3-1/4 (83)	3-3/4 (95)	4-3/4 (121)	3-1/4 (83)	3-3/4 (95)	4-3/4 (121)	3-1/4 (83)	3-3/4 (95)	4-3/4 (121)
Nominal Embedment h_{nom}	in. (mm)	4 (102)	4-1/2 (114)	5-1/2 (140)	4 (102)	4-1/2 (114)	5-1/2 (140)	4 (102)	4-1/2 (114)	5-1/2 (140)	4 (102)	4-1/2 (114)	5-1/2 (140)	4 (102)	4-1/2 (114)	5-1/2 (140)	4 (102)	4-1/2 (114)	5-1/2 (140)
Spacing (s) / Edge Distance (c _e) / Concrete Thickness (h) - in. (mm)	3-3/4 (95)	n/a	n/a	n/a	n/a	n/a	0.47	n/a	n/a	n/a	n/a	n/a	0.18	n/a	n/a	0.36	n/a	n/a	n/a
	4 (102)	n/a	0.68	0.64	n/a	0.44	0.48	n/a	0.56	0.56	n/a	0.24	0.20	n/a	0.44	0.40	n/a	n/a	n/a
	4-1/2 (114)	n/a	0.70	0.66	n/a	0.48	0.52	n/a	0.57	0.56	n/a	0.29	0.24	n/a	0.48	0.47	n/a	n/a	n/a
	5 (127)	0.76	0.72	0.68	0.42	0.51	0.55	0.57	0.58	0.57	0.27	0.33	0.28	0.42	0.51	0.55	n/a	n/a	n/a
	5-1/4 (133)	0.77	0.73	0.68	0.44	0.53	0.57	0.57	0.58	0.57	0.29	0.36	0.30	0.44	0.53	0.57	n/a	n/a	n/a
	5-1/2 (140)	0.78	0.74	0.69	0.46	0.55	0.59	0.58	0.59	0.58	0.31	0.39	0.32	0.46	0.55	0.59	0.55	n/a	n/a
	5-3/4 (146)	0.79	0.76	0.70	0.48	0.58	0.61	0.58	0.59	0.58	0.33	0.41	0.34	0.48	0.58	0.61	0.57	n/a	n/a
	6 (152)	0.81	0.77	0.71	0.50	0.60	0.63	0.58	0.60	0.58	0.35	0.44	0.36	0.50	0.60	0.63	0.58	0.62	n/a
	7 (178)	0.86	0.81	0.75	0.58	0.70	0.70	0.60	0.61	0.60	0.45	0.55	0.46	0.58	0.70	0.70	0.62	0.67	n/a
	7-1/2 (191)	0.88	0.83	0.76	0.63	0.75	0.75	0.60	0.62	0.61	0.49	0.61	0.51	0.63	0.75	0.75	0.65	0.69	n/a
	8 (203)	0.91	0.86	0.78	0.67	0.80	0.80	0.61	0.63	0.61	0.54	0.68	0.56	0.67	0.80	0.80	0.67	0.72	0.67
	9 (229)	0.96	0.90	0.82	0.75	0.90	0.90	0.63	0.64	0.63	0.65	0.81	0.67	0.75	0.90	0.90	0.71	0.76	0.71
	10 (254)	1.00	0.94	0.85	0.83	1.00	1.00	0.64	0.66	0.64	0.76	0.94	0.78	0.83	1.00	1.00	0.75	0.80	0.75
	11 (279)	1.00	0.99	0.89	0.92			0.65	0.68	0.66	0.88	1.00	0.90	0.92			0.78	0.84	0.79
	12 (305)		1.00	0.92	1.00			0.67	0.69	0.67	1.00		1.00	1.00			0.82	0.88	0.82
	16 (406)			1.00				0.72	0.76	0.73							0.94	1.00	0.95
	18 (457)							0.75	0.79	0.75							1.00		1.00
24 (610)							0.83	0.89	0.84										
> 36 (914)							1.00	1.00	1.00										

3.3.5

Table 31 – Load adjustment factors for Stainless Steel 3/4-in. diameter KB-TZ2 in cracked concrete^{1,2}

3/4-in. KB-TZ2 cracked concrete		Spacing factor in tension f_{AN}			Edge distance factor in tension f_{RN}			Spacing factor in shear ³ f_{AV}			Edge distance in shear						Concrete thickness factor in shear ⁴ f_{HV}		
											⊥ Toward edge f_{RV}			∥ To edge f_{RV}					
Effective Embedment h_{ef}	in. (mm)	3-1/4 (83)	3-3/4 (95)	4-3/4 (121)	3-1/4 (83)	3-3/4 (95)	4-3/4 (121)	3-1/4 (83)	3-3/4 (95)	4-3/4 (121)	3-1/4 (83)	3-3/4 (95)	4-3/4 (121)	3-1/4 (83)	3-3/4 (95)	4-3/4 (121)	3-1/4 (83)	3-3/4 (95)	4-3/4 (121)
Nominal Embedment h_{nom}	in. (mm)	4 (102)	4-1/2 (114)	5-1/2 (140)	4 (102)	4-1/2 (114)	5-1/2 (140)	4 (102)	4-1/2 (114)	5-1/2 (140)	4 (102)	4-1/2 (114)	5-1/2 (140)	4 (102)	4-1/2 (114)	5-1/2 (140)	4 (102)	4-1/2 (114)	5-1/2 (140)
Spacing (s) / Edge Distance (c _e) / Concrete Thickness (h) - in. (mm)	3-3/4 (95)	n/a	n/a	n/a	n/a	n/a	0.65	n/a	n/a	n/a	n/a	n/a	0.15	n/a	n/a	0.29	n/a	n/a	n/a
	4 (102)	n/a	0.68	0.64	n/a	0.78	0.68	n/a	0.56	0.55	n/a	0.22	0.16	n/a	0.44	0.32	n/a	n/a	n/a
	4-1/2 (114)	n/a	0.70	0.66	n/a	0.85	0.73	n/a	0.57	0.56	n/a	0.26	0.19	n/a	0.52	0.39	n/a	n/a	n/a
	5 (127)	0.76	0.72	0.68	1.00	0.91	0.77	0.59	0.58	0.56	0.37	0.31	0.23	0.74	0.61	0.45	n/a	n/a	n/a
	5-1/4 (133)	0.77	0.73	0.68	1.00	0.95	0.80	0.59	0.58	0.56	0.40	0.33	0.24	0.79	0.66	0.49	n/a	n/a	n/a
	5-1/2 (140)	0.78	0.74	0.69	1.00	0.98	0.83	0.59	0.58	0.57	0.43	0.35	0.26	0.85	0.71	0.52	0.61	n/a	n/a
	5-3/4 (146)	0.79	0.76	0.70	1.00	1.00	0.85	0.60	0.59	0.57	0.46	0.38	0.28	0.91	0.76	0.56	0.63	n/a	n/a
	6 (152)	0.81	0.77	0.71	1.00	1.00	0.88	0.60	0.59	0.57	0.49	0.40	0.30	0.97	0.81	0.59	0.64	0.60	n/a
	7 (178)	0.86	0.81	0.75	1.00		0.99	0.62	0.61	0.59	0.61	0.51	0.37	1.00	1.00	0.75	0.69	0.65	n/a
	7-1/2 (191)	0.88	0.83	0.76	1.00		1.00	0.63	0.61	0.59	0.68	0.56	0.41	1.00		0.83	0.72	0.67	n/a
	8 (203)	0.91	0.86	0.78	1.00			0.64	0.62	0.60	0.75	0.62	0.46	1.00		0.91	0.74	0.70	0.63
	9 (229)	0.96	0.90	0.82				0.65	0.64	0.61	0.89	0.74	0.54			1.00	0.79	0.74	0.67
	10 (254)	1.00	0.94	0.85				0.67	0.65	0.62	1.00	0.87	0.64			0.83	0.78	0.70	
	11 (279)	1.00	0.99	0.89				0.69	0.67	0.64		1.00	0.74			0.87	0.82	0.74	
	12 (305)		1.00	0.92				0.71	0.68	0.65			0.84			0.91	0.85	0.77	
	16 (406)			1.00				0.77	0.74	0.70			1.00			1.00	0.98	0.89	
	18 (457)							0.81	0.77	0.72							1.00	0.94	
24 (610)							0.91	0.86	0.80								1.00		
> 36 (914)							1.00	1.00	0.94										

1 Linear interpolation not permitted

2 When combining multiple load adjustment factors (e.g. for a 4 anchor pattern in a corner with thin concrete member) the design can become very conservative.

To optimize the design, use Hilti PROFIS Engineering Design software or perform anchor calculation using design equations from ACI 318 Ch. 17 or CSA A23.3 Annex D.

3 Spacing factor reduction in shear, f_{AV} , is applicable when edge distance $c < 3h_{ef}$. If $c \geq 3h_{ef}$ then $f_{AV} = f_{AN}$.

4 Concrete thickness reduction factor in shear, f_{HV} , is applicable when edge distance $c < 3h_{ef}$. If $c \geq 3h_{ef}$ then $f_{HV} = 1.0$.

■ If a reduction factor value is in a shaded cell, this indicates that this specific edge distance may not be permitted with a certain spacing (or vice versa). Check with Figure 3 and Table 21 to calculate permissible edge distance, spacing and concrete thickness combinations.

Table 32 — Load adjustment factors for Stainless Steel 1-in. diameter KB-TZ2 in uncracked concrete^{1,4}

1-in. KB-TZ2 uncracked concrete		Spacing factor in tension f_{AN}		Edge distance factor in tension f_{RN}		Spacing factor in shear ³ f_{AV}		Edge distance in shear				Concrete thickness factor in shear ⁴ f_{HV}	
								⊥ Toward edge f_{RV}		∥ To edge f_{RV}			
Effective Embedment h_{ef}	in. (mm)	4.00 (102)	5.75 (146)	4.00 (102)	5.75 (146)	4.00 (102)	5.75 (146)	4.00 (102)	5.75 (146)	4.00 (102)	5.75 (146)	4.00 (102)	5.75 (146)
Nominal Embedment h_{nom}	in. (mm)	4-5/8 (117)	6-3/8 (162)	4-5/8 (117)	6-3/8 (162)	4-5/8 (117)	6-3/8 (162)	4-5/8 (117)	6-3/8 (162)	4-5/8 (117)	6-3/8 (162)	4-5/8 (117)	6-3/8 (162)
Spacing (s) / Edge Distance (c _e) / Concrete Thickness (h) - in. (mm)	3 (76)	n/a	n/a	n/a	0.302	n/a	n/a	n/a	0.085	n/a	0.170	n/a	n/a
	3-3/4 (95)	n/a	n/a	0.393	0.332	n/a	n/a	0.199	0.119	0.393	0.238	n/a	n/a
	4 (102)	n/a	n/a	0.409	0.342	n/a	n/a	0.219	0.131	0.409	0.262	n/a	n/a
	4-1/4 (108)	n/a	n/a	0.425	0.352	n/a	n/a	0.240	0.144	0.425	0.287	n/a	n/a
	4-3/4 (121)	n/a	0.638	0.458	0.373	n/a	0.551	0.284	0.170	0.458	0.339	n/a	n/a
	5 (127)	0.708	0.645	0.475	0.384	0.576	0.554	0.306	0.183	0.475	0.366	n/a	n/a
	6 (152)	0.750	0.674	0.545	0.429	0.591	0.565	0.403	0.241	0.545	0.429	n/a	n/a
	6-3/4 (171)	0.781	0.696	0.614	0.464	0.602	0.573	0.481	0.287	0.614	0.464	n/a	n/a
	8 (203)	0.833	0.732	0.727	0.525	0.621	0.586	0.620	0.371	0.727	0.525	0.696	n/a
	10 (254)	0.917	0.790	0.909	0.645	0.652	0.608	0.867	0.518	0.909	0.645	0.778	0.656
	12 (305)	1.000	0.848	1.000	0.774	0.682	0.629	1.000	0.681	1.000	0.774	0.853	0.718
	18 (457)		1.000	1.000	1.000	0.773	0.694		1.000		1.000	1.000	0.880
	24 (610)						0.864	0.758					1.000
	36 (914)					1.000	0.887						
> 48 (1219)					1.000								

Table 33 — Load adjustment factors for Stainless Steel 1-in. diameter KB-TZ2 in cracked concrete^{1,4}

1-in. KB-TZ2 cracked concrete		Spacing factor in tension f_{AN}		Edge distance factor in tension f_{RN}		Spacing factor in shear ³ f_{AV}		Edge distance in shear				Concrete thickness factor in shear ⁴ f_{HV}	
								⊥ Toward edge f_{RV}		∥ To edge f_{RV}			
Effective Embedment h_{ef}	in. (mm)	4.00 (102)	5.75 (146)	4.00 (102)	5.75 (146)	4.00 (102)	5.75 (146)	4.00 (102)	5.75 (146)	4.00 (102)	5.75 (146)	4.00 (102)	5.75 (146)
Nominal Embedment h_{nom}	in. (mm)	4-5/8 (117)	6-3/8 (162)	4-5/8 (117)	6-3/8 (162)	4-5/8 (117)	6-3/8 (162)	4-5/8 (117)	6-3/8 (162)	4-5/8 (117)	6-3/8 (162)	4-5/8 (117)	6-3/8 (162)
Spacing (s) / Edge Distance (c _e) / Concrete Thickness (h) - in. (mm)	3 (76)	n/a	n/a	n/a	0.542	n/a	n/a	n/a	0.081	n/a	0.162	n/a	n/a
	3-3/4 (95)	n/a	n/a	0.721	0.596	n/a	n/a	0.170	0.113	0.340	0.226	n/a	n/a
	4 (102)	n/a	n/a	0.750	0.614	n/a	n/a	0.188	0.124	0.375	0.249	n/a	n/a
	4-1/4 (108)	n/a	n/a	0.779	0.633	n/a	n/a	0.205	0.136	0.411	0.272	n/a	n/a
	4-3/4 (121)	n/a	0.638	0.840	0.671	n/a	0.549	0.243	0.161	0.485	0.322	n/a	n/a
	5 (127)	0.708	0.645	0.871	0.690	0.568	0.552	0.262	0.174	0.524	0.348	n/a	n/a
	6 (152)	0.750	0.674	1.000	0.770	0.582	0.562	0.344	0.228	0.689	0.457	n/a	n/a
	6-3/4 (171)	0.781	0.696		0.833	0.592	0.570	0.411	0.273	0.822	0.545	n/a	n/a
	8 (203)	0.833	0.732		0.943	0.609	0.583	0.530	0.352	1.000	0.703	0.661	n/a
	10 (254)	0.917	0.790		1.000	0.636	0.604	0.741	0.491		0.983	0.739	0.644
	12 (305)	1.000	0.848			0.664	0.625	0.974	0.646		1.000	0.809	0.706
	18 (457)		1.000			0.746	0.687	1.000	1.000			0.991	0.864
	24 (610)					0.828	0.749					1.000	0.998
	36 (914)					0.991	0.874						1.000
> 48 (1219)					1.000	0.998							

1 Linear interpolation not permitted

2 When combining multiple load adjustment factors (e.g. for a 4 anchor pattern in a corner with thin concrete member) the design can become very conservative.

To optimize the design, use Hilti PROFIS Engineering Design software or perform anchor calculation using design equations from ACI 318 Ch. 17 or CSA A23.3 Annex D.

3 Spacing factor reduction in shear, f_{AV} , is applicable when edge distance $c < 3h_{ef}$. If $c \geq 3h_{ef}$, then $f_{AV} = f_{AN}$.

4 Concrete thickness reduction factor in shear, f_{HV} , is applicable when edge distance $c < 3h_{ef}$. If $c \geq 3h_{ef}$, then $f_{HV} = 1.0$.

■ If a reduction factor value is in a shaded cell, this indicates that this specific edge distance may not be permitted with a certain spacing (or vice versa). Check with Figure 3 and Table 21 to calculate permissible edge distance, spacing and concrete thickness combinations.

Table 34 – Hilti Carbon Steel KB-TZ2 in the soffit of uncracked lightweight concrete over metal deck, applicable for both hammer and core drilled installations^{1,2,3,4,5,6}

Nominal anchor diameter in.	Effective embedment in. (mm)	Nominal embedment in. (mm)	Installation per Figure 4				Installation per Figure 5			
			Min. conc. thickness ⁸ in. (mm)	Tension - ΦN_n		Shear - ΦV_n	Min. conc. thickness ⁸ in. (mm)	Tension - ΦN_n		Shear - ΦV_n
				$f'_c = 3,000$ psi (20.7 MPa) lb (kN)	$f'_c = 4,000$ psi (27.6 MPa) lb (kN)			$f'_c = 3,000$ psi (20.7 MPa) lb (kN)	$f'_c = 3,000$ psi (20.7 MPa) lb (kN)	
1/4	1-1/2 (38)	1-3/4 (44)	2-1/2 (64)	775 (3.4)	820 (3.6)	1,060 (4.7)	2-1/4 (57)	620 (2.8)	655 (2.9)	730 (3.2)
	1-1/2 (38)	1-7/8 (48)	2-1/2 (64)	1,205 (5.4)	1,285 (5.7)	880 (3.9)	2-1/4 (57)	645 (2.9)	685 (3.0)	1,540 (6.9)
3/8	2 (51)	2-1/2 (64)	2-1/2 (64)	1,705 (7.6)	1,830 (8.1)	1,380 (6.1)	2-1/4 (57)	1,615 (7.2)	1,730 (7.7)	1,630 (7.3)
	2-1/2 (64)	3 (76)	2-1/2 (64)	1,945 (8.7)	2,155 (9.6)	1,380 (6.1)	N/A	N/A	N/A	N/A
1/2	1-1/2 (38)	2 (51)	2-1/2 (64)	1,205 (5.4)	1,390 (6.2)	1,165 (5.2)	2-1/4 (57)	1,180 (5.2)	1,365 (6.1)	1,740 (7.7)
	2 (51)	2-1/2 (64)	2-1/2 (64)	1,790 (8.0)	2,015 (9.0)	1,470 (6.5)	2-1/4 (57)	1,235 (5.5)	1,395 (6.2)	2,065 (9.2)
	2-1/2 (64)	3 (76)	2-1/2 (64)	2,435 (10.8)	2,645 (11.8)	2,135 (9.5)	N/A	N/A	N/A	N/A
	3-1/4 (83)	3-3/4 (95)	2-1/2 (64)	3,065 (13.6)	3,390 (15.1)	2,755 (12.3)	3-1/4 (83)	1,730 (7.7)	1,915 (8.5)	2,250 (10.0)
5/8	2-3/4 (70)	3-1/4 (83)	2-1/2 (64)	2,870 (12.8)	3,315 (14.7)	2,480 (11.0)	3-1/4 (83)	1,925 (8.6)	2,225 (9.9)	2,655 (11.8)
	4 (102)	4-1/2 (114)	2-1/2 (64)	3,780 (16.8)	4,365 (19.4)	3,025 (13.5)	N/A	N/A	N/A	N/A
3/4	3-1/4 (83)	4 (102)	2-1/2 (64)	2,470 (11.0)	2,730 (12.1)	2,655 (11.8)	N/A	N/A	N/A	N/A
	3-3/4 ⁹ (95)	4-1/2 (114)	3-1/4 (83)	3,115 (13.9)	3,405 (15.1)	5,110 (22.7)	N/A	N/A	N/A	N/A

3.3.5

Table 35 – Hilti Carbon Steel KB-TZ2 in the soffit of cracked lightweight concrete over metal deck, applicable for both hammer and core drilled installations^{1,2,3,4,5,6,7}

Nominal anchor diameter in.	Effective embedment in. (mm)	Nominal embedment in. (mm)	Installation per Figure 4				Installation per Figure 5			
			Min. conc. thickness ⁸ in. (mm)	Tension - ΦN_n		Shear - ΦV_n	Min. conc. thickness ⁸ in. (mm)	Tension - ΦN_n		Shear - ΦV_n
				$f'_c = 3,000$ psi (20.7 MPa) lb (kN)	$f'_c = 4,000$ psi (27.6 MPa) lb (kN)			$f'_c = 3,000$ psi (20.7 MPa) lb (kN)	$f'_c = 3,000$ psi (20.7 MPa) lb (kN)	
1/4	1-1/2 (38)	1-3/4 (44)	2-1/2 (64)	230 (1.0)	260 (1.2)	1,060 (4.7)	2-1/4 (57)	185 (0.8)	205 (0.9)	730 (3.2)
	1-1/2 (38)	1-7/8 (48)	2-1/2 (64)	1,055 (4.7)	1,220 (5.4)	880 (3.9)	2-1/4 (57)	565 (2.5)	650 (2.9)	1,540 (6.9)
3/8	2 (51)	2-1/2 (64)	2-1/2 (64)	1,490 (6.6)	1,705 (7.6)	1,380 (6.1)	2-1/4 (57)	1,385 (6.2)	1,580 (7.0)	1,630 (7.3)
	2-1/2 (64)	3 (76)	2-1/2 (64)	1,565 (7.0)	1,695 (7.5)	1,380 (6.1)	N/A	N/A	N/A	N/A
1/2	1-1/2 (38)	2 (51)	2-1/2 (64)	1,075 (4.8)	1,230 (5.5)	1,165 (5.2)	2-1/4 (57)	960 (4.3)	1,100 (4.9)	1,740 (7.7)
	2 (51)	2-1/2 (64)	2-1/2 (64)	1,390 (6.2)	1,600 (7.1)	1,470 (6.5)	2-1/4 (57)	960 (4.3)	1,110 (4.9)	2,065 (9.2)
	2-1/2 (64)	3 (76)	2-1/2 (64)	2,130 (9.5)	2,435 (10.9)	2,135 (9.5)	N/A	N/A	N/A	N/A
	3-1/4 (83)	3-3/4 (95)	2-1/2 (64)	2,170 (9.7)	2,435 (10.8)	2,755 (12.3)	3-1/4 (83)	1,230 (5.5)	1,380 (6.1)	2,250 (10.0)
5/8	2-3/4 (70)	3-1/4 (83)	2-1/2 (64)	2,555 (11.4)	2,950 (13.1)	2,480 (11.0)	3-1/4 (83)	1,715 (7.6)	1,980 (8.8)	2,655 (11.8)
	4 (102)	4-1/2 (114)	2-1/2 (64)	2,855 (12.7)	3,300 (14.7)	3,025 (13.5)	N/A	N/A	N/A	N/A
3/4	3-1/4 (83)	4 (102)	2-1/2 (64)	2,160 (9.6)	2,395 (10.7)	2,655 (11.8)	N/A	N/A	N/A	N/A
	3-3/4 (95)	4-1/2 (114)	3-1/4 (83)	2,425 (10.8)	2,735 (12.2)	5,110 (22.7)	N/A	N/A	N/A	N/A

1 See Section 3.1.8 to convert design strength value to ASD value.
 2 Linear interpolation between embedment depths and concrete compressive strengths is not permitted.
 3 Tabular value is for one anchor per flute. Minimum spacing along the length of the flute is $3 \times h_{ef}$ (effective embedment).
 4 Tabular values are lightweight concrete and no additional reduction factor is needed.
 5 No additional reduction factors for spacing or edge distance need to be applied.
 6 Comparison of the tabular values to the steel strength is not necessary. Tabular values control.
 7 Tabular values are for static loads only. Seismic design is not permitted for uncracked concrete. For seismic tension loads, multiply cracked concrete tabular values in tension only by $\alpha_{N,seis} = 0.75$, except for $3/4 \times 4-3/4 h_{ef}$ where $\alpha_{N,seis} = 0.73$. See Section 3.1.8 for additional information on seismic applications.
 8 Minimum concrete thickness over the upper flute when anchor is installed in the lower flute. See Figure 4 and 5.
 9 For core drilled installations of $3/4"$ anchors installed at $3-3/4"$ effective embedment, apply a reduction factor of 0.89 to the design tension strength of anchors installed in uncracked concrete.

Figure 4 — Installation of Hilti KB-TZ2 carbon steel in the soffit of concrete over metal deck floor and roof assemblies – W deck²

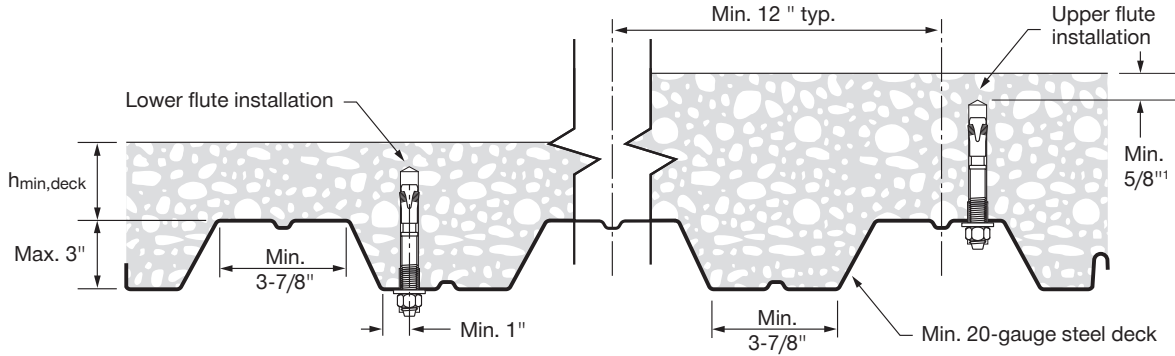
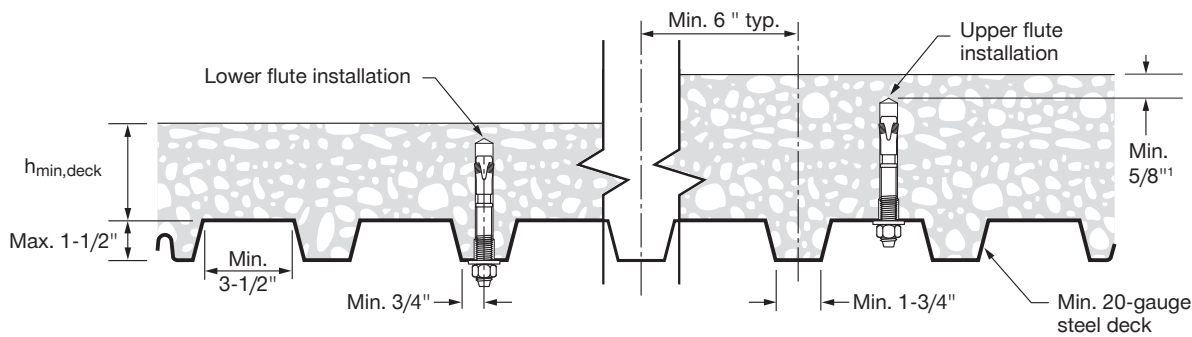

Figure 5 — Installation of Hilti KB-TZ2 carbon steel in the soffit of concrete over metal deck floor and roof assemblies – B deck



- 1 5/8" clearance between the bottom of the drilled hole and the concrete surface is only applicable for upper flute installations. Refer to Tables 34 and 35 for minimum concrete thicknesses for installations into the lower flute.
- 2 For flute widths greater or equal to 4-1/2", the shear strength may be increased. Refer to ESR-4266 for more information.

Table 36 — Hilti KB-TZ2 carbon steel anchors setting information for installation on the top of concrete-filled profile steel deck assemblies according to figure 6^{1,2,3}

Design information	Symbol	Units	Nominal anchor diameter (in)			
			1/4	3/8	1/2	
Effective minimum embedment	h_{ef}	in.	1-1/2	1-1/2	2	2
Nominal minimum embedment	h_{nom}	in.	1-3/4	1-7/8	2-1/2	2-1/2
Minimum hole depth	h_0	in.	2	2	2-1/2	2-3/4
Minimum concrete thickness ⁴	$h_{min,deck}$	in.	2-1/2	2-1/2	2-1/2	3-2/4
Critical edge distance	$c_{ac,deck,top}$	in.	5	8	4-1/2	6
Minimum edge distance	$c_{min,deck,top}$	in.	3	16		7-1/2
Minimum spacing	$s_{min,deck,top}$	in.	3	8		9
Required installation torque	T_{inst}	ft-lb	4	30		50

- 1 Installation must comply with Figure 6 of this report.
- 2 Design capacity shall be based on calculations according to values in Tables 2 and 3 of this report.
- 3 Applicable for $h_{min,deck} < 4$ -in. For $h_{min,deck} \geq 4$ -in, use setting information in Tables 1 and 5 of this section.
- 4 Minimum concrete thickness refers to concrete thickness above the upper flute. See Figure 6.

Figure 6 — KB-TZ2 Installation in the top of concrete filled profile steel deck assemblies

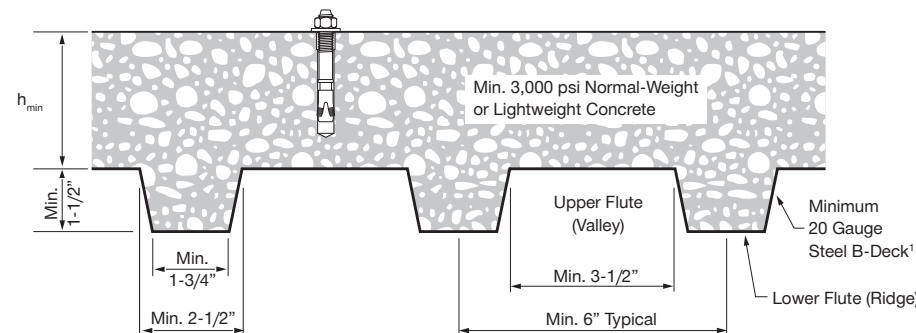

1 1-1/2-in B-deck as a minimum profile size. Other deck profiles meeting the B-deck minimum dimensions are also permitted

DESIGN DATA IN CONCRETE PER CSA A23.3

CSA A23.3 Annex D Design

Limit State Design of anchors is described in the provisions of CSA A23.3 Annex D for post-installed anchors tested and assessed in accordance with ACI 355.2 for mechanical anchors and ACI 355.4 for adhesive anchors. Tables 37, 38, 42 and 43 in this section contains the Limit State Design tables that are based on the published loads in ICC-ES Evaluation Report ESR 4266 and converted for use with CSA A23.3 Annex D. Tables 40, 41, 45 and 46 are Hilti Simplified Design Tables which are pre-factored resistance tables based on the design parameters and variables in Tables 37, 38, 42 and 43. All the figures in the previous ACI 318 Chapter 17 design section are applicable to Limit State Design and the tables will reference these figures.

For a detailed explanation of the tables developed in accordance with CSA A23.3 Annex D, refer to Section 3.1.8. Technical assistance is available by contacting Hilti Canada at (800) 363 4458 or at www.hilti.ca.

Table 37 – Hilti KB-TZ2 carbon steel tension design information in accordance with CSA A23.3 Annex D, applicable for both hammer and core drilled installations¹



Design parameter	Symbol	Units	Nominal anchor diameter (in.)																Ref A23.3	
			1/4		3/8		1/2		5/8		3/4		1							
Effective min. embedment ²	h_{ef}	in. (mm)	1-1/2 (38)	1-1/2 (38)	2 (51)	2-1/2 (64)	1-1/2 (38)	2 (51)	2-1/2 (64)	3-1/4 (83)	2-3/4 (70)	3-1/4 (83)	4 (102)	3-1/4 (83)	3-3/4 (95)	4-3/4 (121)	4 (102)	5-3/4 (146)		
Min. concrete thickness	h_{min}	in. (mm)	See Table 5																	
Minimum edge distance	c_{min}	in. (mm)	See Table 5																	
Minimum anchor spacing	s_{min}	in. (mm)	See Table 5																	
Tension, steel failure modes																				
Steel embed. material resistance factor for reinforcement	Φ_s	-	0.85	0.85	0.85	0.85	0.85	0.85	0.85	0.85	0.85	0.85	0.85	0.85	0.85	0.85	0.85	0.85	8.4.3	
Resistance modification factor for tension, steel failure modes ³	R	-	0.80	0.80	0.80	0.80	0.80	0.80	0.80	0.80	0.80	0.80	0.80	0.80	0.80	0.80	0.80	0.80	D.5.3	
Min. specified yield strength	f_{ya}	psi (N/mm ²)	100,900 (696)	100,900 (696)	100,900 (696)	100,900 (696)	96,300 (664)	96,300 (664)	96,300 (664)	96,300 (664)	87,000 (600)	87,000 (600)	87,000 (600)	84,700 (584)	84,700 (584)	84,700 (584)	84,700 (584)	75,000 (517)		
Min. specified ult. strength	f_{ut}	psi (N/mm ²)	122,400 (844)	122,400 (844)	126,200 (870)	126,200 (870)	114,000 (786)	114,000 (786)	114,000 (786)	114,000 (786)	106,700 (736)	106,700 (736)	106,700 (736)	105,900 (730)	105,900 (730)	105,900 (730)	105,900 (730)	88,000 (607)		
Effective tensile stress area	$A_{se,N}$	in ² (mm ²)	0.024 (15.4)	0.024 (15.4)	0.051 (33.2)	0.051 (33.2)	0.099 (63.6)	0.099 (63.6)	0.099 (63.6)	0.099 (63.6)	0.164 (106.0)	0.164 (106.0)	0.164 (106.0)	0.239 (154.4)	0.239 (154.4)	0.239 (154.4)	0.239 (154.4)	0.470 (303.2)		
Factored steel resistance in tension	N_{sar}	lb (kN)	1,985 (8.8)	1,985 (8.8)	4,420 (19.7)	4,420 (19.7)	7,645 (34.0)	7,645 (34.0)	7,645 (34.0)	7,645 (34.0)	11,925 (53.0)	11,925 (53.0)	11,925 (53.0)	17,230 (76.6)	17,230 (76.6)	17,230 (76.6)	17,230 (76.6)	28,145 (125.2)	D.6.1.2	
Tension, concrete failure modes																				
Anchor category	-	-	3	1	1	1	1	1	1	1	1	1	1	1	1	1	1	1	D.5.3 (c)	
Concrete material resistance factor	Φ_c	-	0.65	0.65	0.65	0.65	0.65	0.65	0.65	0.65	0.65	0.65	0.65	0.65	0.65	0.65	0.65	0.65	8.4.2	
Resistance modification factor for tension and shear, concrete failure modes, Condition B ⁵	R	-	0.75	1.00	1.00	1.00	1.00	1.00	1.00	1.00	1.00	1.00	1.00	1.00	1.00	1.00	1.00	1.00	D.5.3 (c)	
Coeff. for factored conc. breakout resistance, uncracked concrete	$k_{c,uncr}$	-	10.0	10.0	10.0	10.0	11.3	11.3	10.0	10.0	10.0	10.0	10.0	11.3	11.3 ⁷	10.0	11.3	10.0	D.6.2.2	
Coeff. for factored conc. breakout resistance, cracked concrete	$k_{c,cr}$	-	7.1	8.8	8.8	7.1	10.0	8.8	8.8	7.1	8.8	8.8	7.1	8.8	8.8	8.8	8.8	8.8	D.6.2.2	
Modification factor for anchor resistance, tension, uncracked conc. ⁴	$\Psi_{c,N}$	-	1.0	1.0	1.0	1.0	1.0	1.0	1.0	1.0	1.0	1.0	1.0	1.0	1.0	1.0	1.0	1.0		
Critical edge distance	c_{ac}	in. (mm)	4 (102)	5 (127)	4-3/8 (111)	5-1/2 (140)	8 (203)	5-1/2 (140)	6-3/4 (171)	10 (254)	10 (254)	11-1/2 (292)	8-3/4 (222)	12 (305)	10 (254)	9 (229)	11 (279)	16 (406)		
Factored pullout resistance in 20 MPa uncracked concrete ⁶	$N_{pr,uncr}$	lb (kN)	1,055 (4.7)	N/A	N/A	N/A	N/A	N/A	N/A	N/A	N/A	N/A	N/A	N/A	N/A	N/A	N/A	N/A	D.6.3.2	
Factored pullout resistance in 20 MPa cracked concrete ⁶	$N_{pr,cr}$	lb (kN)	325 (1.4)	N/A	N/A	N/A	N/A	N/A	N/A	N/A	N/A	N/A	N/A	N/A	N/A	N/A	N/A	6,000 (26.7)	8,275 (36.8)	D.6.3.2
Factored pullout resistance in 20 MPa cracked concrete, seismic ⁶	$N_{pr,eq}$	lb (kN)	325 (1.4)	N/A	N/A	N/A	N/A	N/A	N/A	N/A	N/A	N/A	N/A	N/A	N/A	N/A	N/A	5,880 (26.1)	8,275 (36.8)	D.6.3.2
Normalization factor, uncracked concrete	n_{uncr}	-	0.20	0.22	0.24	0.35	0.50	0.42	0.29	0.35	0.50	0.48	0.50	0.35	0.31	0.39	N/A	0.38		
Normalization factor, cracked concrete, seismic	n_{cr}	-	0.39	0.50	0.46	0.28	0.47	0.50	0.48	0.40	0.50	0.47	0.50	0.36	0.42	0.29	N/A	0.50		

1 Design information in this table is taken from ICC-ES ESR-4266, dated December, 2020, and revised July, 2021 Tables 4 and 6, and converted for use with CSA A23.3 Annex D.
 2 See Figure 1 of this document.
 3 The KB-TZ2 carbon steel anchor is considered a ductile steel element as defined by CSA A23.3 Annex D section D.2.
 4 For all design cases, $\Psi_{c,N} = 1.0$. The appropriate coefficient for breakout resistance for cracked concrete ($k_{c,cr}$) or uncracked concrete ($k_{c,uncr}$) must be used.
 5 For use with the load combinations of CSA A23.3 chapter 8. Condition B applies where supplementary reinforcement in conformance with CSA A23.3 section D.5.3 is not provided, or where pullout or pryout strength governs. For cases where the presence of supplementary reinforcement can be verified, the resistance modification factors associated with Condition A may be used.
 6 For all design cases, $\Psi_{c,P} = 1.0$. Tabular value for pullout strength is for a concrete compressive strength of 2,900 psi (20.0 MPa). Pullout strength for concrete compressive strength greater than 2,900 psi (20.2 MPa) may be increased by multiplying the tabular pullout strength by $(f'_c / 2,900)^n$ for psi, or $(f'_c / 20.2)^n$ for MPa,
 7 For core drilled installation $k_{c,uncr} = 10.0$ for 3/4" diameter installed at 3-3/4" effective embedment.

Table 38 — Hilti KB-TZ2 carbon steel shear design information in accordance with CSA A23.3 Annex D, applicable for both hammer and core drilled installations ¹



Design parameter	Symbol	Units	Nominal anchor diameter (in.)																Ref A23.3
			1/4	3/8			1/2			5/8			3/4			1			
Anchor O.D.	d_a	in. (mm)	0.25 (6.4)	0.375 (9.5)			0.5 (12.7)			0.625 (15.9)			0.75 (19.1)			1.00 (25.4)			
Effective min. embedment ²	h_{ef}	in. (mm)	1-1/2 (38)	1-1/2 (38)	2 (51)	2-1/2 (64)	1-1/2 (38)	2 (51)	2-1/2 (64)	3-1/4 (83)	2-3/4 (70)	3-1/4 (83)	4 (102)	3-1/4 (83)	3-3/4 (95)	4-3/4 (121)	4 (102)	5-3/4 (146)	
Shear, steel failure modes																			
Steel embed. material resistance factor for reinforcement	Φ_s	-	0.85	0.85			0.85			0.85			0.85			0.85		8.4.3	
Resistance modification factor for shear, steel failure modes ³	R	-	0.75	0.75			0.75			0.75			0.75			0.75		D.5.3	
Factored steel resistance in shear	V_{sar}	lb (kN)	855 (3.8)	2,055 (9.1)			3,530 (15.7)			6,540 (29.1)			8,800 (39.1)			11,980 (53.3)	14,550 (64.7)	D.7.1.2	
Factored steel resistance in shear, seismic	$V_{sar,eq}$	lb (kN)	855 (3.8)	2,055 (9.1)			3,530 (15.7)			6,540 (29.1)			8,800 (39.1)			8,800 (39.1)			
Shear, concrete failure modes																			
Concrete material resistance factor	Φ_c	-	0.65	0.65			0.65			0.65			0.65			0.65		8.4.2	
Resistance modification factor for shear, concrete failure modes ⁴	R	-	1.00	1.00			1.00			1.00			1.00			1.00		D.5.3	
Load bearing length of anchor in shear	l_o	in. (mm)	1-1/2 (38)	1-1/2 (38)	2 (51)	2-1/2 (64)	1-1/2 (38)	2 (51)	2-1/2 (64)	3-1/4 (83)	2-3/4 (70)	3-1/4 (83)	4 (102)	3-1/4 (83)	3-3/4 (95)	4-3/4 (121)	4 (102)	5-3/4 (146)	
Effectiveness factor for pryout	k_{cp}	-	1.0	1.0	1.0	2.0	1.0	1.0	2.0	2.0	2.0	2.0	2.0	2.0	2.0	2.0	2.0	2.0	

¹ Design information in this table is taken from ICC-ES ESR-4266, dated December, 2020, and revised July, 2021 Tables 4 and 6, and converted for use with CSA A23.3 Annex D.

² See Figure 1 of this document.

³ The KB-TZ2 carbon steel anchor is considered a ductile steel element as defined by CSA A23.3 Annex D section D.2.

⁴ For use with the load combinations of CSA A23.3 chapter 8. Condition B applies where supplementary reinforcement in conformance with CSA A23.3 section D.5.3 is not provided, or where pullout or pryout strength governs. For cases where the presence of supplementary reinforcement can be verified, the resistance modification factors associated with Condition A may be used.

Table 39 — Steel resistance for Hilti KB-TZ2 carbon steel anchors ^{1,2}



Nominal anchor diameter in.	Effective embedment depth in. (mm)			Tensile ³ ΦN_{sar} lb (kN)	Shear ⁴ ΦV_{sar} lb (kN)	Seismic Shear ⁵ $\Phi V_{sar,eq}$ lb (kN)
1/4	1-1/2 (38)			1,985 (8.8)	855 (3.8)	855 (3.8)
3/8	1-1/2 (38)			4,420 (19.7)	2,055 (9.1)	2,055 (9.1)
3/8	2 (51)	2-1/2 (64)		4,420 (19.7)	2,160 (9.6)	2,160 (9.6)
1/2	1-1/2 (38)		2 (51)	7,645 (34.0)	3,530 (15.7)	3,530 (15.7)
1/2	2-1/2 (64)		3-1/4 (83)	7,645 (34.0)	4,385 (19.5)	4,385 (19.5)
5/8	2-3/4 (70)	3-1/4 (83)	4 (102)	11,925 (53.0)	6,540 (29.1)	6,540 (29.1)
3/4	3-1/4 (83)	3-3/4 (95)	4-3/4 (121)	17,230 (76.6)	8,800 (39.1)	8,800 (39.1)
1	4 (102)			28,145 (125.2)	11,980 (53.3)	8,800 (39.1)
1	5-3/4 (146)			28,145 (125.2)	14,550 (64.7)	8,800 (39.1)

¹ See Section 3.1.8 to convert factored resistance value to ASD value.

² Hilti KB-TZ2 carbon steel anchors are to be considered ductile steel elements.

³ Tensile $N_{sar} = A_{se,N} \Phi_s f_{uta} R$ as noted in CSA A23.3 Annex D.

⁴ Shear determined by static shear tests with $V_{sar} < 0.6 A_{se,V} \Phi_s f_{uta} R$ as noted in CSA A23.3 Annex D.

⁵ Seismic shear values determined by seismic shear tests with $V_{sar,eq} \leq 0.60 A_{se,V} \Phi_s f_{uta} R$ as noted in CSA A23.3 Annex D.

See Section 3.1.8 for additional information on seismic applications.



Table 40 – Hilti KB-TZ2 carbon steel factored resistance based on concrete failure modes in uncracked concrete, applicable for both hammer and core drilled installations^{1,2,3,4}

Nominal anchor diameter in.	Effective embedment in. (mm)	Nominal embedment in. (mm)	Tension - N_t				Shear - V_r			
			$f'_c = 20$ MPa (2,900 psi) lb (kN)	$f'_c = 25$ MPa (3,625 psi) lb (kN)	$f'_c = 30$ MPa (4,350 psi) lb (kN)	$f'_c = 40$ MPa (5,800 psi) lb (kN)	$f'_c = 20$ MPa (2,900 psi) lb (kN)	$f'_c = 25$ MPa (3,625 psi) lb (kN)	$f'_c = 30$ MPa (4,350 psi) lb (kN)	$f'_c = 40$ MPa (5,800 psi) lb (kN)
1/4	1 1/2 (38)	1 3/4 (44)	1,055 (4.7)	1,105 (4.9)	1,145 (5.1)	1,210 (5.4)	1,535 (6.8)	1,720 (7.6)	1,880 (8.4)	2,175 (9.7)
	1 1/2 (38)	1 7/8 (48)	1,535 (6.8)	1,720 (7.6)	1,880 (8.4)	2,175 (9.7)	1,535 (6.8)	1,720 (7.6)	1,880 (8.4)	2,175 (9.7)
3/8	2 (51)	2 1/2 (64)	2,365 (10.5)	2,645 (11.8)	2,900 (12.9)	3,345 (14.9)	2,365 (10.5)	2,645 (11.8)	2,900 (12.9)	3,345 (14.9)
	2 1/2 (64)	3 (76)	2,865 (12.7)	3,095 (13.8)	3,300 (14.7)	3,650 (16.2)	3,305 (14.7)	3,695 (16.4)	4,050 (18.0)	4,675 (20.8)
1/2	1 1/2 (38)	2 (51)	1,735 (7.7)	1,940 (8.6)	2,125 (9.5)	2,455 (10.9)	1,735 (7.7)	1,940 (8.6)	2,125 (9.5)	2,455 (10.9)
	2 (51)	2 1/2 (64)	2,675 (11.9)	2,990 (13.3)	3,275 (14.6)	3,780 (16.8)	2,675 (11.9)	2,990 (13.3)	3,275 (14.6)	3,780 (16.8)
	2 1/2 (64)	3 (76)	3,305 (14.7)	3,695 (16.4)	4,050 (18.0)	4,675 (20.8)	3,305 (14.7)	3,695 (16.4)	4,050 (18.0)	4,675 (20.8)
	3 1/4 (83)	3 3/4 (95)	4,900 (21.8)	5,480 (24.4)	6,005 (26.7)	6,930 (30.8)	9,805 (43.6)	10,960 (48.8)	12,005 (53.4)	13,865 (61.7)
5/8	2 3/4 (70)	3 1/4 (83)	3,770 (16.8)	4,215 (18.7)	4,615 (20.5)	5,330 (23.7)	7,630 (33.9)	8,530 (37.9)	9,345 (41.6)	10,790 (48.0)
	3 1/4 (83)	3 3/4 (95)	4,900 (21.8)	5,480 (24.4)	6,005 (26.7)	6,930 (30.8)	9,805 (43.6)	10,960 (48.8)	12,005 (53.4)	13,865 (61.7)
	4 (102)	4 1/2 (114)	6,300 (28.0)	7,045 (31.3)	7,720 (34.3)	8,910 (39.6)	13,385 (59.5)	14,965 (66.6)	16,395 (72.9)	18,930 (84.2)
3/4	3 1/4 (83)	4 (102)	4,900 (21.8)	5,480 (24.4)	6,005 (26.7)	6,930 (30.8)	9,805 (43.6)	10,960 (48.8)	12,005 (53.4)	13,865 (61.7)
	3 3/4 (95)	4 1/2 (114)	6,865 (30.5)	7,675 (34.1)	8,405 (37.4)	9,710 (43.2)	13,730 (61.1)	15,350 (68.3)	16,815 (74.8)	19,415 (86.4)
	4 3/4 (121)	5 1/2 (140)	8,660 (38.5)	9,685 (43.1)	10,605 (47.2)	12,250 (54.5)	17,320 (77.0)	19,365 (86.1)	21,215 (94.4)	24,495 (109.0)
1	4 (102)	4 5/8 (117)	7,560 (33.6)	8,455 (37.6)	9,260 (41.2)	10,695 (47.6)	15,125 (67.3)	16,910 (75.2)	18,525 (82.4)	21,390 (95.1)
	5 3/4 (146)	6 3/8 (162)	11,535 (51.3)	12,895 (57.4)	14,125 (62.8)	16,310 (72.6)	23,070 (102.6)	25,790 (114.7)	28,255 (125.7)	32,625 (145.1)

3.3.5

Table 41 – Hilti KB-TZ2 carbon steel factored resistance based on concrete failure modes in cracked concrete, applicable for both hammer and core drilled installations^{1,2,3,4,5}



Nominal anchor diameter in.	Effective embedment in. (mm)	Nominal embedment in. (mm)	Tension - N_t				Shear - V_r			
			$f'_c = 20$ MPa (2,900 psi) lb (kN)	$f'_c = 25$ MPa (3,625 psi) lb (kN)	$f'_c = 30$ MPa (4,350 psi) lb (kN)	$f'_c = 40$ MPa (5,800 psi) lb (kN)	$f'_c = 20$ MPa (2,900 psi) lb (kN)	$f'_c = 25$ MPa (3,625 psi) lb (kN)	$f'_c = 30$ MPa (4,350 psi) lb (kN)	$f'_c = 40$ MPa (5,800 psi) lb (kN)
1/4	1 1/2 (38)	1 3/4 (44)	325 (1.4)	350 (1.6)	380 (1.7)	425 (1.9)	1,090 (4.9)	1,220 (5.4)	1,335 (5.9)	1,545 (6.9)
3/8	1 1/2 (38)	1 7/8 (48)	1,350 (6.0)	1,510 (6.7)	1,655 (7.4)	1,915 (8.5)	1,350 (6.0)	1,510 (6.7)	1,655 (7.4)	1,915 (8.5)
	2 (51)	2 1/2 (64)	2,080 (9.3)	2,330 (10.4)	2,550 (11.3)	2,945 (13.1)	2,080 (9.3)	2,330 (10.4)	2,550 (11.3)	2,945 (13.1)
	2 1/2 (64)	3 (76)	2,350 (10.4)	2,625 (11.7)	2,875 (12.8)	3,320 (14.8)	2,350 (10.4)	2,625 (11.7)	2,875 (12.8)	3,320 (14.8)
1/2	1 1/2 (38)	2 (51)	1,535 (6.8)	1,720 (7.6)	1,880 (8.4)	2,175 (9.7)	1,535 (6.8)	1,720 (7.6)	1,880 (8.4)	2,175 (9.7)
	2 (51)	2 1/2 (64)	2,080 (9.3)	2,330 (10.4)	2,550 (11.3)	2,945 (13.1)	2,080 (9.3)	2,330 (10.4)	2,550 (11.3)	2,945 (13.1)
	2 1/2 (64)	3 (76)	2,910 (12.9)	3,255 (14.5)	3,565 (15.9)	4,115 (18.3)	2,910 (12.9)	3,255 (14.5)	3,565 (15.9)	4,115 (18.3)
	3 1/4 (83)	3 3/4 (95)	3,480 (15.5)	3,890 (17.3)	4,260 (19.0)	4,920 (21.9)	6,960 (31.0)	7,780 (34.6)	8,525 (37.9)	9,845 (43.8)
5/8	2 3/4 (70)	3 1/4 (83)	3,355 (14.9)	3,755 (16.7)	4,110 (18.3)	4,750 (21.1)	6,715 (29.9)	7,505 (33.4)	8,225 (36.6)	9,495 (42.2)
	3 1/4 (83)	3 3/4 (95)	4,315 (19.2)	4,820 (21.5)	5,285 (23.5)	6,100 (27.1)	8,625 (38.4)	9,645 (42.9)	10,565 (47.0)	12,200 (54.3)
	4 (102)	4 1/2 (114)	4,750 (21.1)	5,310 (23.6)	5,820 (25.9)	6,720 (29.9)	9,505 (42.3)	10,625 (47.3)	11,640 (51.8)	13,440 (59.8)
3/4	3 1/4 (83)	4 (102)	4,315 (19.2)	4,820 (21.5)	5,285 (23.5)	6,100 (27.1)	8,625 (38.4)	9,645 (42.9)	10,565 (47.0)	12,200 (54.3)
	3 3/4 (95)	4 1/2 (114)	5,345 (23.8)	5,975 (26.6)	6,545 (29.1)	7,335 (32.6)	10,690 (47.6)	11,955 (53.2)	13,095 (58.2)	15,120 (67.3)
	4 3/4 (121)	5 1/2 (140)	6,000 (26.7)	6,400 (28.5)	6,745 (30.0)	7,335 (32.6)	15,240 (67.8)	17,040 (75.8)	18,670 (83.0)	21,555 (95.9)
1	4 (102)	4 5/8 (117)	5,890 (26.2)	6,585 (29.3)	7,215 (32.1)	8,330 (37.0)	11,780 (52.4)	13,170 (58.6)	14,425 (64.2)	16,660 (74.1)
	5 3/4 (146)	6 3/8 (162)	8,275 (36.8)	9,250 (41.1)	10,135 (45.1)	11,700 (52.0)	20,300 (90.3)	22,695 (101.0)	24,865 (110.6)	28,710 (127.7)

1 See Section 3.1.8 to convert factored resistance value to ASD value.
 2 Linear interpolation between embedment depths and concrete compressive strengths is not permitted.
 3 Apply spacing, edge distance, and concrete thickness factors in tables 6 to 17 as necessary. Compare to the steel values in Table 39. The lesser of the values is to be used for the design.
 4 Tabular values are for normal weight concrete only. For lightweight concrete multiply design strength by λ_c as follows: For sand-lightweight, $\lambda_c = 0.68$; for all-lightweight, $\lambda_c = 0.60$.
 5 Tabular values are for static loads only. Seismic design is not permitted for uncracked concrete. For seismic tension loads, multiply cracked concrete tabular values in tension only by $\alpha_{N,seis} = 0.75$, except for 3/4 x 4-3/4 h_{ef} where $\alpha_{N,seis} = 0.73$. No reduction needed for seismic shear. See Section 3.1.8 for additional information on seismic applications.
 6 For core drilled installations of 3/4" anchors installed at 3-3/4" effective embedment, apply a reduction factor of 0.89 to the design tension strength

Table 42 — Hilti KB-TZ2 stainless steel tension design information in accordance with CSA A23.3 Annex D, applicable for both hammer and core drilled installations ¹



Design parameter	Symbol	Units	Nominal anchor diameter (in.)														Ref A23.3	
			1/4	3/8		1/2		5/8		3/4		1						
Effective min. embedment ²	h_{ef}	in. (mm)	1-1/2 (38)	1-1/2 (38)	2 (51)	2-1/2 (64)	2 (51)	2-1/2 (64)	3-1/4 (83)	2-3/4 (70)	3-1/4 (83)	4 (102)	3-1/4 (83)	3-3/4 (95)	4-3/4 (121)	4 (102)	5-3/4 (146)	
Min. concrete thickness	h_{min}	in. (mm)	See Table 19															
Minimum edge distance	c_{min}	in. (mm)	See Table 19															
Minimum anchor spacing	s_{min}	in. (mm)	See Table 19															
Tension, steel failure modes																		
Steel embed. material resistance factor for reinforcement	Φ_s	-	0.85	0.85		0.85		0.85		0.85		0.85		0.85		0.85		8.4.3
Resistance modification factor for tension, steel failure modes ³	R	-	0.80	0.80		0.80		0.80		0.80		0.80		0.80		0.80		
Min. specified yield strength	f_{ya}	psi (N/mm ²)	100,900 (696)	96,300 (664)		96,300 (664)		91,600 (632)		84,100 (580)		65,000 (448)						
Min. specified ult. strength	f_{ut}	psi (N/mm ²)	122,400 (844)	120,100 (828)		120,400		114,600 (790)		100,500 (693)		99,900 (689)						
Effective tensile stress area	$A_{se,N}$	in ² (mm ²)	0.024 (15.4)	0.051 (33.2)		0.099 (63.6)		0.164 (106.0)		0.239 (154.4)		0.470 (303.2)						
Factored steel resistance in tension	N_{sar}	lb (kN)	2,050 (9.1)	4,210 (18.7)		8,070 (35.9)		12,810 (57.0)		16,350 (72.7)		31,930 (142.0)						D.6.1.2
Tension, concrete failure modes																		
Anchor category	-	-	3	1		1		1		1		1		1		1		D.5.3 (c)
Concrete material resistance factor	Φ_c	-	0.65	0.65		0.65		0.65		0.65		0.65		0.65		0.65		8.4.2
Resistance modification factor for tension and shear, concrete failure modes, Condition B ⁵	R	-	0.75	1.00		1.00		1.00		1.00		1.00		1.00		1.00		D.5.3 (c)
Coeff. for factored conc. breakout resistance, uncracked concrete	$k_{c,uncr}$	-	10.0	10.0	10.0	10.0	10.0	10.0	10.0	10.0	10.0	10.0	10.0	11.3 ⁷	10.0	11.3	11.3	D.6.2.2
Coeff. for factored conc. breakout resistance, cracked concrete	$k_{c,cr}$	-	7.1	8.8	8.8	7.1	7.1	8.8	7.1	8.8	8.8	7.1	8.8	8.8 ⁷	8.8	10.0	8.8	D.6.2.2
Modification factor for anchor resistance, tension, uncracked conc. ⁴	$\Psi_{c,N}$	-	1.0	1.0		1.0		1.0		1.0		1.0		1.0		1.0		
Critical edge distance	c_{ac}	in. (mm)	4 (102)	4-1/2 (114)	5-1/2 (140)	4-1/8 (105)	5-1/2 (140)	6-1/4 (159)	7-1/2 (191)	10 (254)	7 (178)	9 (229)	12 (305)	10 (254)	10 (254)	11 (279)	15-1/2 (394)	
Factored pullout resistance in 20 MPa uncracked concrete ⁶	$N_{pr,uncr}$	lb (kN)	810 (3.6)	N/A	N/A	2,875 (12.8)	2,355 (10.5)	2,810 (12.5)	3,855 (17.1)	2,860 (12.7)	4,165 (18.5)	5,615 (25.0)	N/A	N/A	N/A	N/A	N/A	D.6.3.2
Factored pullout resistance in 20 MPa cracked concrete ⁶	$N_{pr,cr}$	lb (kN)	360 (1.6)	N/A	N/A	N/A	N/A	N/A	N/A ⁸	N/A	N/A	N/A	N/A	N/A	6,160 (27.4)	N/A	N/A	D.6.3.2
Factored pullout resistance in 20 MPa cracked concrete, seismic ⁶	$N_{pr,eq}$	lb (kN)	360 (1.6)	N/A	N/A	N/A	N/A	N/A	N/A ⁸	N/A	N/A	N/A	N/A	N/A	6,160 (27.4)	N/A	N/A	D.6.3.2
Normalization factor, uncracked concrete	n_{uncr}	-	0.39	N/A	N/A	0.37	0.46	0.50	0.50	0.50	0.42	0.47	N/A	N/A	0.30	N/A	N/A	
Normalization factor, cracked concrete, seismic	n_{cr}	-	0.50	N/A	N/A	N/A	N/A	N/A	0.50	N/A	N/A	N/A	N/A	N/A	0.50	N/A	N/A	

1 Design information in this table is taken from ICC-ES ESR-4266, dated December, 2020, and revised July, 2021 Tables 5 and 7, and converted for use with CSA A23.3 Annex D.
2 See Figure 1 of this document.
3 The KB-TZ2 stainless steel anchor is considered a ductile steel element as defined by CSA A23.3 Annex D section D.2.
4 For all design cases, $\Psi_{c,N} = 1.0$. The appropriate coefficient for breakout resistance for cracked concrete ($k_{c,cr}$) or uncracked concrete ($k_{c,uncr}$) must be used.
5 For use with the load combinations of CSA A23.3 chapter 8. Condition B applies where supplementary reinforcement in conformance with CSA A23.3 section D.5.3 is not provided, or where pullout or pryout strength governs. For cases where the presence of supplementary reinforcement can be verified, the resistance modification factors associated with Condition A may be used.
6 For all design cases, $\Psi_{c,p} = 1.0$. Tabular value for pullout strength is for a concrete compressive strength of 2,900 psi (20.0 MPa). Pullout strength for concrete compressive strength greater than 2,900 psi (20.2 MPa) may be increased by multiplying the tabular pullout strength by $(f'_c / 2,900)^n$ for psi, or $(f'_c / 20.2)^n$ for MPa.
7 For core drilled installation $k_{c,uncr} = 10.0$ and $k_{c,cr} = 7.1$ for 3/4" diameter installed at 3-3/4" effective embedment
8 For core drilled installation, $N_{pr,r} = 4245$ lb (18.9 kN) and $N_{pr,eq} = 4245$ lb (18.9 kN) for 1/2-inch diameter anchors installed at 3-3/4 inches (95 mm) effective embedment.

Table 43 – Hilti KB-TZ2 stainless steel shear design information in accordance with CSA A23.3 Annex D, applicable for both hammer and core drilled installations¹



Design parameter	Symbol	Units	Nominal anchor diameter (in.)														Ref A23.3	
			1/4	3/8		1/2		5/8		3/4		1						
Anchor O.D.	d_a	in. (mm)	0.25 (6.4)	0.375 (9.5)		0.5 (12.7)		0.625 (15.9)		0.75 (19.1)		1.00 (25.4)						
Effective min. embedment ²	h_{ef}	in. (mm)	1-1/2 (38)	1-1/2 (38)	2 (51)	2-1/2 (64)	2 (51)	2-1/2 (64)	3-1/4 (83)	2-3/4 (70)	3-1/4 (83)	4 (102)	3-1/4 (83)	3-3/4 (95)	4-3/4 (121)	4 (102)	5-3/4 (146)	
Shear, steel failure modes																		
Steel embed. material resistance factor for reinforcement	Φ_s	-	0.85	0.85		0.85		0.85		0.85		0.85		0.85		0.85		8.4.3
Resistance modification factor for shear, steel failure modes ³	R	-	0.75	0.75		0.75		0.75		0.75		0.75		0.75		0.75		
Factored steel resistance in shear	V_{sar}	lb (kN)	930 (4.1)	2,940 (13.1)	3,115 (13.9)	5,320 (23.7)		7,875 (35.0)		10,555 (47.0)		14,635 (65.1)		20,020 (89.1)				D.7.1.2
Factored steel resistance in shear, seismic	$V_{sar,eq}$	lb (kN)	710 (3.2)	2,940 (13.1)	3,115 (13.9)	5,320 (23.7)		7,875 (35.0)		8,585 (38.2)		8,585 (38.2)		8,585 (38.2)				
Shear, concrete failure modes																		
Concrete material resistance factor	Φ_c	-	0.65	0.65		0.65		0.65		0.65		0.65		0.65		0.65		8.4.2
Resistance modification factor for shear, concrete failure modes ⁴	R	-	0.75	1.00		1.00		1.00		1.00		1.00		1.00		1.00		D.5.3 (c)
Load bearing length of anchor in shear	ℓ_e	in. (mm)	1-1/2 (38)	1-1/2 (38)	2 (51)	2-1/2 (64)	2 (51)	2-1/2 (64)	3-1/4 (83)	2-3/4 (70)	3-1/4 (83)	4 (102)	3-1/4 (83)	3-3/4 (95)	4-3/4 (121)	4 (102)	5-3/4 (146)	
Effectiveness factor for pryout	k_{cp}	-	1.0	1.0	1.0	2.0	1.0	2.0	2.0	2.0	2.0	2.0	2.0	2.0	2.0	2.0	2.0	

1 Design information in this table is taken from ICC-ES ESR-4266, dated December, 2020, and revised July, 2021 Tables 5 and 7, and converted for use with CSA A23.3 Annex D.
 2 See Figure 1 of this document.
 3 The KB-TZ2 stainless steel anchor is considered a ductile steel element as defined by CSA A23.3 Annex D section D.2.
 4 For use with the load combinations of CSA A23.3 chapter 8. Condition B applies where supplementary reinforcement in conformance with CSA A23.3 section D.5.3 is not provided, or where pullout or pryout strength governs. For cases where the presence of supplementary reinforcement can be verified, the resistance modification factors associated with Condition A may be used.

3.3.5

Table 44 – Steel resistance for Hilti KB-TZ2 stainless steel anchors ^{1,2}



Nominal anchor diameter in.	Effective embedment depth in. (mm)			Tensile ³ N_{sar} lb (kN)	Shear ⁴ V_{sar} lb (kN)	Seismic Shear ⁵ $V_{sar,eq}$ lb (kN)
1/4	1-1/2 (38)			2,050 (9.1)	930 (4.1)	710 (3.2)
3/8	1-1/2 (38)			4,210 (18.7)	2,940 (13.1)	2,940 (13.1)
3/8	2 (51)	2-1/2 (64)		4,210 (18.7)	3,115 (13.9)	3,115 (13.9)
1/2	2 (51)	2-1/2 (64)	3-1/4 (83)	8,070 (35.9)	5,320 (23.7)	5,320 (23.7)
5/8	2-3/4 (70)	3-1/4 (83)	4 (102)	12,810 (57.0)	7,875 (35.0)	7,875 (35.0)
3/4	3-1/4 (83)	3-3/4 (95)	4-3/4 (121)	16,350 (72.7)	10,555 (47.0)	8,585 (38.2)
1	4 (102)			31,930 (142.0)	14,635 (65.1)	8,585 (38.2)
1	5-3/4 (146)			31,930 (142.0)	20,020 (89.1)	8,585 (38.2)

1 See Section 3.1.8 to convert factored resistance value to ASD value.
 2 Hilti KB-TZ2 stainless steel anchors are to be considered ductile steel elements.
 3 Tensile $N_{sar} = A_s f_s$ as noted in CSA A23.3 Annex D.
 4 Shear determined by static shear tests with $V_{sar} < 0.6 A_s f_s$ as noted in CSA A23.3 Annex D.
 5 Seismic shear values determined by seismic shear tests with $V_{sar,eq} < 0.6 A_s f_s$ as noted in CSA A23.3 Annex D. See Section 3.1.8 for additional information on seismic applications.

Table 45 — Hilti KB-TZ2 stainless steel factored resistance based on concrete failure modes in uncracked concrete, applicable for both hammer and core drilled installations ^{1,2,3,4}



Nominal anchor diameter in.	Effective embedment in. (mm)	Nominal embedment in. (mm)	Tension - N_t				Shear - V_r			
			$f'_c = 20$ MPa (2,900 psi) lb (kN)	$f'_c = 25$ MPa (3,625 psi) lb (kN)	$f'_c = 30$ MPa (4,350 psi) lb (kN)	$f'_c = 40$ MPa (5,800 psi) lb (kN)	$f'_c = 20$ MPa (2,900 psi) lb (kN)	$f'_c = 25$ MPa (3,625 psi) lb (kN)	$f'_c = 30$ MPa (4,350 psi) lb (kN)	$f'_c = 40$ MPa (5,800 psi) lb (kN)
1/4	1 1/2 (38)	1 3/4 (44)	810 (3.6)	885 (3.9)	950 (4.2)	1,065 (4.7)	1,535 (6.8)	1,720 (7.6)	1,880 (8.4)	2,175 (9.7)
	1 1/2 (38)	1 7/8 (48)	1,535 (6.8)	1,720 (7.6)	1,880 (8.4)	2,175 (9.7)	1,535 (6.8)	1,720 (7.6)	1,880 (8.4)	2,175 (9.7)
3/8	2 (51)	2 1/2 (64)	2,365 (10.5)	2,645 (11.8)	2,900 (12.9)	3,345 (14.9)	2,365 (10.5)	2,645 (11.8)	2,900 (12.9)	3,345 (14.9)
	2 1/2 (64)	3 (76)	2,875 (12.8)	3,125 (13.9)	3,340 (14.9)	3,715 (16.5)	6,615 (29.4)	7,395 (32.9)	8,100 (36.0)	9,355 (41.6)
1/2	2 (51)	2 1/2 (64)	2,355 (10.5)	2,610 (11.6)	2,835 (12.6)	3,240 (14.4)	2,365 (10.5)	2,645 (11.8)	2,900 (12.9)	3,345 (14.9)
	2-1/2 (64)	3 (76)	2,810 (12.5)	3,140 (14.0)	3,440 (15.3)	3,975 (17.7)	6,615 (29.4)	7,395 (32.9)	8,100 (36.0)	9,355 (41.6)
5/8	3 1/4 (83)	3 3/4 (95)	3,855 (17.1)	4,310 (19.2)	4,720 (21.0)	5,450 (24.2)	9,805 (43.6)	10,960 (48.8)	12,005 (53.4)	13,865 (61.7)
	2 3/4 (70)	3 1/4 (83)	2,860 (12.7)	3,200 (14.2)	3,505 (15.6)	4,045 (18.0)	7,630 (33.9)	8,530 (37.9)	9,345 (41.6)	10,790 (48.0)
3/4	3 1/4 (83)	3 3/4 (95)	4,165 (18.5)	4,575 (20.3)	4,935 (22.0)	5,570 (24.8)	9,805 (43.6)	10,960 (48.8)	12,005 (53.4)	13,865 (61.7)
	4 (102)	4 1/2 (114)	5,615 (25.0)	6,235 (27.7)	6,795 (30.2)	7,775 (34.6)	13,385 (59.5)	14,965 (66.6)	16,395 (72.9)	18,930 (84.2)
1	3 1/4 (83)	4 (102)	4,900 (21.8)	5,480 (24.4)	6,005 (26.7)	6,930 (30.8)	9,805 (43.6)	10,960 (48.8)	12,005 (53.4)	13,865 (61.7)
	3 3/4 (95)	4 1/2 (114)	6,865 (30.5)	7,675 (34.1)	8,405 (37.4)	9,710 (43.2)	13,730 (61.1)	15,350 (68.3)	16,815 (74.8)	19,415 (86.4)
1	4 (102)	5 1/2 (140)	8,660 (38.5)	9,685 (43.1)	10,605 (47.2)	12,250 (54.5)	17,320 (77.0)	19,365 (86.1)	21,215 (94.4)	24,495 (109.0)
	4 (102)	4 5/8 (117)	7,560 (33.6)	8,455 (37.6)	9,260 (41.2)	10,695 (47.6)	15,125 (67.3)	16,910 (75.2)	18,525 (82.4)	21,390 (95.1)
1	5 3/4 (146)	6 3/8 (162)	13,035 (58.0)	14,570 (64.8)	15,965 (71.0)	18,435 (82.0)	26,070 (116.0)	29,145 (129.6)	31,925 (142.0)	36,865 (164.0)

Table 46 — Hilti KB-TZ2 stainless steel factored resistance based on concrete failure modes in cracked concrete, applicable for both hammer and core drilled installations ^{1,2,3,4}



Nominal anchor diameter in.	Effective embedment in. (mm)	Nominal embedment in. (mm)	Tension - N_t				Shear - V_r			
			$f'_c = 20$ MPa (2,900 psi) lb (kN)	$f'_c = 25$ MPa (3,625 psi) lb (kN)	$f'_c = 30$ MPa (4,350 psi) lb (kN)	$f'_c = 40$ MPa (5,800 psi) lb (kN)	$f'_c = 20$ MPa (2,900 psi) lb (kN)	$f'_c = 25$ MPa (3,625 psi) lb (kN)	$f'_c = 30$ MPa (4,350 psi) lb (kN)	$f'_c = 40$ MPa (5,800 psi) lb (kN)
1/4	1 1/2 (38)	1 3/4 (44)	470 (2.1)	525 (2.3)	575 (2.6)	665 (3.0)	820 (3.6)	915 (4.1)	1,000 (4.5)	1,155 (5.1)
	1 1/2 (38)	1 7/8 (48)	1,350 (6.0)	1,510 (6.7)	1,655 (7.4)	1,915 (8.5)	1,350 (6.0)	1,510 (6.7)	1,655 (7.4)	1,915 (8.5)
3/8	2 (51)	2 1/2 (64)	2,080 (9.3)	2,330 (10.4)	2,550 (11.3)	2,945 (13.1)	2,080 (9.3)	2,330 (10.4)	2,550 (11.3)	2,945 (13.1)
	2 1/2 (64)	3 (76)	2,350 (10.4)	2,625 (11.7)	2,875 (12.8)	3,320 (14.8)	4,695 (20.9)	5,250 (23.4)	5,750 (25.6)	6,640 (29.5)
1/2	2 (51)	2 1/2 (64)	1,680 (7.5)	1,880 (8.4)	2,060 (9.2)	2,375 (10.6)	1,680 (7.5)	1,880 (8.4)	2,060 (9.2)	2,375 (10.6)
	2-1/2 (64)	3 (76)	2,910 (12.9)	3,255 (14.5)	3,565 (15.9)	4,115 (18.3)	5,820 (25.9)	6,505 (28.9)	7,130 (31.7)	8,230 (36.6)
5/8	3 1/4 (83)	3 3/4 (95)	3,480 (15.5)	3,890 (17.3)	4,260 (19.0)	4,920 (21.9)	6,960 (31.0)	7,780 (34.6)	8,525 (37.9)	9,845 (43.8)
	2 3/4 (70)	3 1/4 (83)	3,355 (14.9)	3,755 (16.7)	4,110 (18.3)	4,750 (21.1)	6,715 (29.9)	7,505 (33.4)	8,225 (36.6)	9,495 (42.2)
3/4	3 1/4 (83)	3 3/4 (95)	4,315 (19.2)	4,820 (21.5)	5,285 (23.5)	6,100 (27.1)	8,625 (38.4)	9,645 (42.9)	10,565 (47.0)	12,200 (54.3)
	4 (102)	4 1/2 (114)	4,750 (21.1)	5,310 (23.6)	5,820 (25.9)	6,720 (29.9)	9,505 (42.3)	10,625 (47.3)	11,640 (51.8)	13,440 (59.8)
1	3 1/4 (83)	4 (102)	4,315 (19.2)	4,820 (21.5)	5,285 (23.5)	6,100 (27.1)	8,625 (38.4)	9,645 (42.9)	10,565 (47.0)	12,200 (54.3)
	3 3/4 (95)	4 1/2 (114)	5,345 (23.8)	5,975 (26.6)	6,545 (29.1)	7,560 (33.6)	10,690 (47.6)	11,955 (53.2)	13,095 (58.2)	15,120 (67.3)
1	4 (102)	5 1/2 (140)	6,160 (27.4)	6,890 (30.6)	7,545 (33.6)	8,715 (38.8)	15,240 (67.8)	17,040 (75.8)	18,670 (83.0)	21,555 (95.9)
	4 (102)	4 5/8 (117)	6,690 (29.8)	7,480 (33.3)	8,195 (36.5)	9,465 (42.1)	13,385 (59.5)	14,965 (66.6)	16,395 (72.9)	18,930 (84.2)
1	5 3/4 (146)	6 3/8 (162)	10,150 (45.2)	11,350 (50.5)	12,430 (55.3)	14,355 (63.9)	20,300 (90.3)	22,695 (101.0)	24,865 (110.6)	28,710 (127.7)

1 See Section 3.1.8 to convert factored resistance value to ASD value.
 2 Linear interpolation between embedment depths and concrete compressive strengths is not permitted.
 3 Apply spacing, edge distance, and concrete thickness factors in tables 22 to 33 as necessary. Compare to the steel values in Table 43. The lesser of the values is to be used for the design.
 4 Tabular values are for normal weight concrete only. For lightweight concrete multiply design strength by λ_a as follows: For sand-lightweight, $\lambda_a = 0.68$; for all-lightweight, $\lambda_a = 0.60$.
 5 Tabular values are for static loads only. Seismic design is not permitted for uncracked concrete. For seismic tension loads, multiply cracked concrete tabular values in tension only by $\alpha_{N,seis} = 0.75$. No reduction needed for seismic shear, except for the 3/4 bolts where $\alpha_{V,seis} = 0.81$. See Section 3.1.8 for additional information on seismic applications.
 6 For core drilled installations of 3/4" anchors installed at 3-3/4" effective embedment, apply a reduction factor of 0.89 to the design tension strength.
 7 For core drilled installations of 3/4" anchors installed at 3-3/4" effective embedment, apply a reduction factor of 0.81 to the design tension strength.
 8 For core drilled installations of 1/2" anchors installed at 3-1/4" effective embedment, apply a reduction factor of 0.85 to the design tension strength.



Table 47 – Hilti KB-TZ2 carbon steel factored resistance in the soffit of uncracked lightweight concrete over metal deck, applicable for both hammer and core drilled installations^{1,2,3,4,5,6}

Nominal anchor diameter in.	Nominal embedment in. (mm)	Installation per Figure 4				Installation per Figure 5			
		Min. conc. thickness ⁸ in. (mm)	Tension - N_r		Shear - V_r	Min. conc. thickness ⁸ in. (mm)	Tension - N_r		Shear - V_r
			$f'_c = 20$ MPa (2,900 psi) lb (kN)	$f'_c = 30$ MPa (4,350 psi) lb (kN)	$f'_c \geq 20$ MPa (2,900 psi) lb (kN)		$f'_c = 20$ MPa (2,900 psi) lb (kN)	$f'_c = 30$ MPa (4,350 psi) lb (kN)	$f'_c \geq 20$ MPa (2,900 psi) lb (kN)
1/4	1-3/4 (44)	2-1/2 (64)	835 (3.7)	905 (4.0)	1,040 (4.6)	2-1/4 (57)	670 (3.0)	725 (3.2)	715 (3.2)
3/8	1-7/8 (48)	2-1/2 (64)	1,195 (5.3)	1,310 (5.8)	865 (3.8)	2-1/4 (57)	640 (2.8)	700 (3.1)	1,510 (6.7)
	2-1/2 (64)	2-1/2 (64)	1,690 (7.5)	1,865 (8.3)	1,350 (6.0)	2-1/4 (57)	1,600 (7.1)	1,765 (7.9)	1,595 (7.1)
	3 (76)	2-1/2 (64)	1,925 (8.6)	2,215 (9.9)	1,350 (6.0)	N/A	N/A	N/A	N/A
1/2	2 (51)	2-1/2 (64)	1,185 (5.3)	1,450 (6.4)	1,140 (5.1)	2-1/4 (57)	1,160 (5.2)	1,420 (6.3)	1,710 (7.6)
	2-1/2 (64)	2-1/2 (64)	1,760 (7.8)	2,090 (9.3)	1,440 (6.4)	2-1/4 (57)	1,220 (5.4)	1,445 (6.4)	2,025 (9.0)
	3-1/4 (83)	2-1/2 (64)	2,410 (10.7)	2,710 (12.1)	2,095 (9.3)	N/A	N/A	N/A	N/A
	3-3/4 (95)	2-1/2 (64)	3,030 (13.5)	3,490 (15.5)	2,700 (12.0)	3-1/4 (83)	1,710 (7.6)	1,975 (8.8)	2,210 (9.8)
5/8	3-1/4 (83)	2-1/2 (64)	2,820 (12.5)	3,455 (15.4)	2,430 (10.8)	3-1/4 (83)	1,890 (8.4)	2,315 (10.3)	2,605 (11.6)
	4-1/2 (114)	2-1/2 (64)	3,715 (16.5)	4,550 (20.2)	2,965 (13.2)	N/A	N/A	N/A	N/A
3/4	4 (102)	2-1/2 (64)	2,440 (10.9)	2,815 (12.5)	2,605 (11.6)	N/A	N/A	N/A	N/A
	4-1/2 ⁹ (114)	3-1/4 (83)	3,085 (13.7)	3,495 (15.5)	5,015 (22.3)	N/A	N/A	N/A	N/A

3.3.5

Table 48 – Hilti KB-TZ2 carbon steel factored resistance in the soffit of cracked lightweight concrete over metal deck, applicable for both hammer and core drilled installations^{1,2,3,4,5,6,7}



Nominal anchor diameter in.	Nominal embedment in. (mm)	Installation per Figure 4				Installation per Figure 5			
		Min. conc. thickness ⁸ in. (mm)	Tension - N_r		Shear - V_r	Min. conc. thickness ⁸ in. (mm)	Tension - N_r		Shear - V_r
			$f'_c = 20$ MPa (2,900 psi) lb (kN)	$f'_c = 30$ MPa (4,350 psi) lb (kN)	$f'_c \geq 20$ MPa (2,900 psi) lb (kN)		$f'_c = 20$ MPa (2,900 psi) lb (kN)	$f'_c = 30$ MPa (4,350 psi) lb (kN)	$f'_c \geq 20$ MPa (2,900 psi) lb (kN)
1/4	1-3/4 (44)	2-1/2 (64)	250 (1.1)	290 (1.3)	1,040 (4.6)	2-1/4 (57)	195 (0.9)	230 (1.0)	715 (3.2)
3/8	1-7/8 (48)	2-1/2 (64)	1,040 (4.6)	1,270 (5.6)	865 (3.8)	2-1/4 (57)	555 (2.5)	680 (3.0)	1,510 (6.7)
	2-1/2 (64)	2-1/2 (64)	1,470 (6.5)	1,770 (7.9)	1,350 (6.0)	2-1/4 (57)	1,365 (6.1)	1,645 (7.3)	1,595 (7.1)
	3 (76)	2-1/2 (64)	1,550 (6.9)	1,735 (7.7)	1,350 (6.0)	N/A	N/A	N/A	N/A
1/2	2 (51)	2-1/2 (64)	1,055 (4.7)	1,275 (5.7)	1,140 (5.1)	2-1/4 (57)	945 (4.2)	1,160 (5.1)	1,710 (7.6)
	2-1/2 (64)	2-1/2 (64)	1,365 (6.1)	1,670 (7.4)	1,440 (6.4)	2-1/4 (57)	945 (4.2)	1,160 (5.2)	2,025 (9.0)
	3-1/4 (83)	2-1/2 (64)	2,095 (9.3)	2,545 (11.3)	2,095 (9.3)	N/A	N/A	N/A	N/A
	3-3/4 (95)	2-1/2 (64)	2,140 (9.5)	2,520 (11.2)	2,700 (12.0)	3-1/4 (83)	1,210 (5.4)	1,425 (6.3)	2,210 (9.8)
5/8	3-1/4 (83)	2-1/2 (64)	2,510 (11.2)	3,075 (13.7)	2,430 (10.8)	3-1/4 (83)	1,685 (7.5)	2,060 (9.2)	2,605 (11.6)
	4-1/2 (114)	2-1/2 (64)	2,810 (12.5)	3,440 (15.3)	2,965 (13.2)	N/A	N/A	N/A	N/A
3/4	4 (102)	2-1/2 (64)	2,135 (9.5)	2,470 (11.0)	2,605 (11.6)	N/A	N/A	N/A	N/A
	4-1/2 (114)	3-1/4 (83)	2,400 (10.7)	2,700 (12.0)	5,015 (22.3)	N/A	N/A	N/A	N/A

1 See Section 3.1.8 to convert design strength value to ASD value.
 2 Linear interpolation between embedment depths and concrete compressive strengths is not permitted.
 3 Tabular value is for one anchor per flute. Minimum spacing along the length of the flute is $3 \times h_{ef}$ (effective embedment).
 4 Tabular values are lightweight concrete and no additional reduction factor is needed.
 5 No additional reduction factors for spacing or edge distance need to be applied.
 6 Comparison of the tabular values to the steel strength is not necessary. Tabular values control.
 7 Tabular values are for static loads only. Seismic design is not permitted for uncracked concrete. For seismic loads, multiply cracked concrete tabular values in tension only by $\alpha_{N,seis} = 0.75$, except for 3/4 x 4-3/4 h_{ef} where $\alpha_{N,seis} = 0.73$. See Section 3.1.8 for additional information on seismic applications.
 8 Minimum concrete thickness over the upper flute when anchor is installed in the lower flute. See Figure 4 and 5.
 9 For core drilled installations of 3/4" anchors installed at 4-1/2" nominal embedment, apply a reduction factor of 0.89 to the design tension strength of anchors installed in uncracked concrete.

DESIGN INFORMATION IN MASONRY

Table 49 — Allowable tensile loads for Hilti KB-TZ2 carbon steel and stainless steel anchors in the face of grout-filled concrete masonry unit (CMU) walls^{1,3,4,5,6}

Nominal anchor diameter in.	Nominal embedment in. (mm)		Allowable Tensile capacity at s_{cr} and c_{cr} lb (kN)		Spacing			Edge Distance						
					Critical spacing, s_{cr} in (mm)		Minimum spacing ² , s_{min} in (mm)	Load Multiplier at s_{min}	Critical edge distance, c_{cr} in (mm)	Minimum edge distance, c_{min} in (mm)	Load Multiplier at c_{min}			
1/4	1-3/4	(44)	145	(0.6)	6	(152)	3	(76)	0.62	12	(305)	4	(102)	0.87
3/8	1-7/8	(48)	405	(1.8)	6	(152)		0.49	0.80					
	3	(76)	590	(2.6)	10	(254)	0.58	0.93						
1/2	2-1/2	(64)	500	(2.2)	8	(203)	4	(102)	0.59					0.94
	3-3/4	(95)	640	(2.8)	13	(330)		0.78	1.00					
5/8	3-1/4	(83)	890	(4.0)	11	(279)	5	(127)	0.66					20
	4-1/2	(114)	940	(4.2)	16	(406)		0.61	0.96					
3/4	4	(102)	1,245	(5.5)	13	(330)	6	(152)	0.49	0.75				
	5-1/2	(140)	1,385	(6.2)	19	(483)		0.45	0.82					

Table 50 — Allowable shear loads for Hilti KB-TZ2 carbon steel and stainless steel anchors in the face of grout-filled concrete masonry unit (CMU) walls^{1,3,4,5,6}

Nominal anchor diameter in.	Nominal embedment in. (mm)		Allowable shear capacity at s_{cr} and c_{cr} lb (kN)		Spacing			Edge Distance											
					Critical spacing, s_{cr} in (mm)		Minimum spacing, s_{min} ² in (mm)	Load multiplier at s_{min}	Critical edge distance, c_{cr} in (mm)	Minimum edge distance, c_{min} in (mm)	Perpendicular load reduction factor at c_{min}	Parallel load reduction factor at c_{min}							
1/4	1-3/4	(44)	320	(1.4)	6	(152)	3	(76)	0.73	12	(305)	4	(102)	1.00	1.00				
3/8	1-7/8	(48)	585	(2.6)	6	(152)		0.76						0.99					
	3	(76)	695	(3.1)	10	(254)	0.50	0.83											
1/2	2-1/2	(64)	1,045	(4.7)	8	(203)	4	(102)						20	(508)	4	(102)	0.36	0.75
	3-3/4	(95)			13	(330)		0.35										0.85	
5/8	3-1/4	(83)	1,735	(7.7)	11	(279)	5	(127)										0.36	0.75
	4-1/2	(114)	2,050	(9.1)	16	(406)		0.35	0.85										
3/4	4	(102)	1,735	(7.7)	13	(330)	6	(152)	0.36	0.75									
	5-1/2	(140)	2,050	(9.1)	19	(483)		0.35	0.85										

1 Values valid for anchors installed in face shells of Type 1, Grade N, lightweight, medium-weight, or normal-weight concrete masonry units conforming to ASTM C90. The masonry units must be fully grouted with coarse grout conforming to 2018 and 2015 IBC Section 2103.3, 2012 IBC Section 2103.13, or 2009 IBC Section 2103.12. Mortar must comply with 2018 and 2015 IBC Section 2103.2.1, 2012 IBC Section 2103.9, or 2009 IBC Section 2103.8. Masonry compressive strength must be at least 1,500 psi at the time of anchor installation.

2 Loads tabulated are applicable to anchors spaced a critical distance of 4 times the effective embedment. The anchors may be placed at a minimum spacing, s_{min} , provided that reductions are applied to the tabulated values.

3 Anchors must be installed a minimum of 1-3/8-inches from any vertical mortar joint in accordance with Figure 6.

4 Embedment depth must be measured from the outside face of the concrete masonry unit.

5 For intermediate edge and spacing distances, allowable loads may be determined by linearly interpolating between the allowable loads at the two tabulated edge or spacing distances.

6 The tabulated allowable loads have been calculated based on a safety factor of 5.0.

Table 51 – Allowable tensile and shear loads for Hilti KB-TZ2 carbon and stainless steel anchors in the top of grout-filled concrete masonry walls ^{1,3,4,5,6}

Nominal anchor diameter in.	Nominal embedment		Minimum edge distance from edge of wall, C_{min}		Minimum spacing, ² s_{min}		Minimum end distance C_{end}		Allowable tensile capacity		Allowable shear capacity			
	in.	(mm)	in.	(mm)	in.	(mm)	in.	(mm)	lb	(kN)	Parallel to edge of masonry wall		Perpendicular to edge of masonry wall	
											lb	(kN)	lb	(kN)
3/8	1-7/8	(48)	1-3/4	(44)	6	(152)	12	(305)	300	(1.3)	325	(1.4)	175	(0.8)
	3	(76)			10	(254)	12	(305)	395	(1.8)	475	(2.1)	220	(1.0)
1/2	2-1/2	(64)			8	(203)	12	(305)	385	(1.7)	500	(2.2)	195	(0.9)
	3-3/4	(95)			13	(330)	12	(305)	485	(2.2)	610	(2.7)	240	(1.1)
5/8	3-1/4	(83)	2-3/4	(70)	11	(279)	12	(305)	620	(2.8)	930	(4.1)	410	(1.8)
	4-1/2	(114)			16	(406)	12	(305)	865	(3.8)	1240	(5.5)	465	(2.1)

- 1 Values valid for anchors installed in face shells of Type 1, Grade N, lightweight, medium-weight, or normal-weight concrete masonry units conforming to ASTM C90. The masonry units must be fully grouted with coarse grout conforming to 2018 and 2015 IBC Section 2103.3, 2012 IBC Section 2103.13, or 2009 IBC Section 2103.12. Mortar must comply with 2018 and 2015 IBC Section 2103.2.1, 2012 IBC Section 2103.9, or 2009 IBC Section 2103.8. Masonry compressive strength must be at least 1,500 psi at the time of anchor installation.
- 2 Loads tabulated are applicable to anchors spaced a critical distance of 4 times the effective embedment. The anchors may be placed at a minimum spacing, s_{min} , provided that reductions are applied to the tabulated values.
- 3 Anchors must be installed a minimum of 1-3/8 inches from any head joint in accordance with Figure 6.
- 4 Embedment depth must be measured from the outside face of the concrete masonry unit.
- 5 For intermediate edge and spacing distances, allowable loads may be determined by linearly interpolating between the allowable loads at the two tabulated edge or spacing distances.
- 6 The tabulated allowable loads have been calculated based on a safety factor of 5.0.

Figure 7 – Acceptable locations (shaded areas) for Hilti KB-TZ2 anchors in the face of grout-filled CMU walls

3.3.5

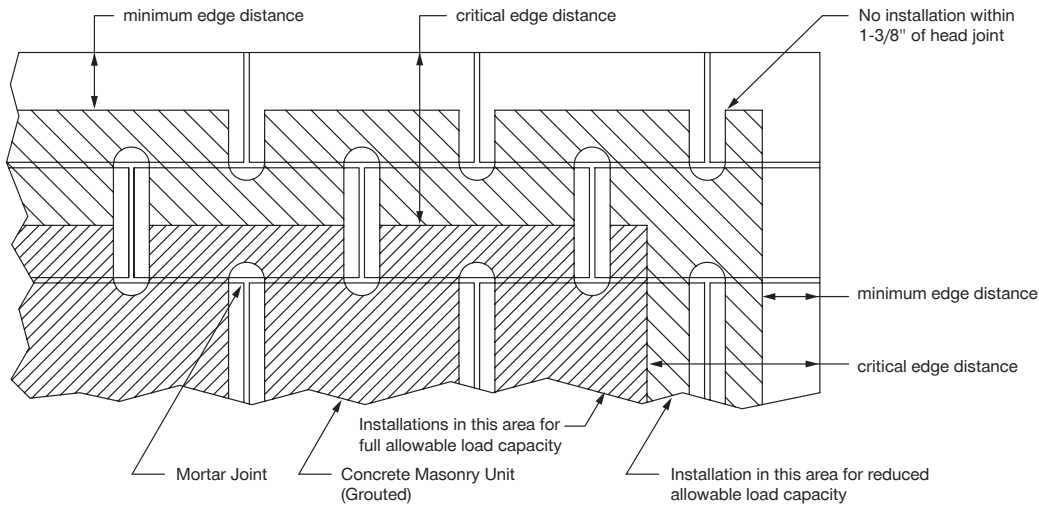

Anchor installation is restricted to shaded areas

Figure 8 – Edge and end distances for the Hilti KB-TZ2 anchors installed in the top of grout-filled CMU walls

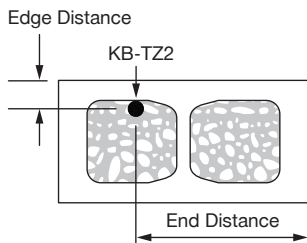

INSTALLATION INSTRUCTIONS

Installation Instructions For Use (IFU) are included with each product package. They can also be viewed or downloaded online at www.hilti.com. Because of the possibility of changes, always verify that downloaded IFU are current when used. Proper installation is critical to achieve full performance. Training is available on request. Contact Hilti Technical Services for applications and conditions not addressed in the IFU.

ORDERING INSTRUCTIONS

Table 52 — Hilti KB-TZ2 carbon steel product portfolio

Description	Length (in)	Length ident. letter	Thread length (in)	Nominal embed. 1 (in)	Min. fixture thickness 1 (in)	Max. fixture thickness 1 (in)	Nominal embed. 2 (in)	Min. fixture thickness 2 (in)	Max. fixture thickness 2 (in)	Nominal embed. 3 (in)	Min. fixture thickness 3 (in)	Max. fixture thickness 3 (in)	Nominal embed. 4 (in)	Min. fixture thickness 4 (in)	Max. fixture thickness 4 (in)	Package quantity
KB-TZ2 1/4 x 2-1/8	2-1/8	B	7/8	1-3/4	0	1/8	-	-	-	-	-	-	-	-	-	100
KB-TZ2 1/4 x 2-1/2	2-1/2	C	1-1/4	1-3/4	0	1/2	-	-	-	-	-	-	-	-	-	100
KB-TZ2 1/4 x 3-1/4	3-1/4	D	2	1-3/4	0	1-1/4	-	-	-	-	-	-	-	-	-	100
KB-TZ2 1/4 x 4-1/2	4-1/2	G	3	1-3/4	1/8	2-1/2	-	-	-	-	-	-	-	-	-	100
KB-TZ2 3/8 x 2-1/2	2-1/2	C	1	1-7/8	0	1/4	-	-	-	-	-	-	-	-	-	50
KB-TZ2 3/8 x 3	3	D	1 1/2	1-7/8	0	3/4	2-1/2	0	1/4	-	-	-	-	-	-	50
KB-TZ2 3/8 x 3-1/2	3-1/2	Q	2	1-7/8	0	1-1/4	2-1/2	0	3/4	3	0	1/4	-	-	-	50
KB-TZ2 3/8 x 3-3/4	3-3/4	E	2-1/4	1-7/8	0	1-1/2	2-1/2	0	1	3	0	1/2	-	-	-	50
KB-TZ2 3/8 x 5	5	H	3-1/2	1-7/8	0	2-3/4	2-1/2	0	2-1/4	3	0	1-3/4	-	-	-	50
KB-TZ2 3/8 x 7	7	L	4-7/8	1-7/8	1/2	4-3/4	2-1/2	0	4-1/4	3	0	3-3/4	-	-	-	50
KB-TZ2 1/2 x 3	3	D	1-1/8	2	1/4	1/2	2-1/2	0	0	-	-	-	-	-	-	20
KB-TZ2 1/2 x 3-3/4	3-3/4	E	1-5/8	2	1/2	1-1/4	2-1/2	0	3/4	3	0	1/4	-	-	-	20
KB-TZ2 1/2 x 4-1/2	4-1/2	G	2-3/8	2	1/2	2	2-1/2	0	1-1/2	3	0	1	3-3/4	0	1/4	20
KB-TZ2 1/2 x 5-1/2	5-1/2	I	3-3/8	2	1/2	3	2-1/2	0	2-1/2	3	0	2	3-3/4	0	1-1/4	20
KB-TZ2 1/2 x 7	7	L	4-3/4	2	5/8	4-1/2	2-1/2	1/8	4	3	0	3-1/2	3-3/4	0	2-3/4	20
KB-TZ2 1/2 x 8-1/2	8-1/2	O	4-7/8	2	2	6	2-1/2	1-1/2	5-1/2	3	1	5	3-3/4	1/4	4-1/4	20
KB-TZ2 1/2 x 10	10	R	4-7/8	2	3-1/2	7-1/2	2-1/2	3	7	3	2-1/2	6-1/2	3-3/4	1-3/4	5-3/4	20
KB-TZ2 5/8 x 4-1/4	4-1/4	F	2-1/4	3-1/4	0	3/8	-	-	-	-	-	-	-	-	-	15
KB-TZ2 5/8 x 4-3/4	4-3/4	G	2-3/4	3-1/4	0	7/8	3-3/4	0	3/8	-	-	-	-	-	-	15
KB-TZ2 5/8 x 5-1/2	5-1/2	I	3-1/2	3-1/4	0	1-5/8	3-3/4	0	1-1/8	4-1/2	0	3/8	-	-	-	15
KB-TZ2 5/8 x 6	6	J	4	3-1/4	0	2-1/8	3-3/4	0	1-5/8	4-1/2	0	7/8	-	-	-	15
KB-TZ2 5/8 x 7	7	L	4-7/8	3-1/4	0	3-1/8	3-3/4	0	2-5/8	4-1/2	0	1-7/8	-	-	-	15
KB-TZ2 5/8 x 8-1/2	8-1/2	O	6-1/2	3-1/4	0	4-5/8	3-3/4	0	4-1/8	4-1/2	0	3-3/8	-	-	-	15
KB-TZ2 5/8 x 10	10	R	7-1/8	3-1/4	1/8	6-1/8	3-3/4	0	5-5/8	4-1/2	0	4-7/8	-	-	-	15
KB-TZ2 3/4 x 4-3/4	4-3/4	G	2-1/2	4	0	1/8	-	-	-	-	-	-	-	-	-	10
KB-TZ2 3/4 x 5-1/2	5-1/2	I	3-1/4	4	0	7/8	4-1/2	0	3/8	-	-	-	-	-	-	10
KB-TZ2 3/4 x 6-1/4	6-1/4	J	3-1/4	4	0	1-5/8	4-1/2	0	1-1/8	5-1/2	0	1/8	-	-	-	10
KB-TZ2 3/4 x 7	7	L	4	4	0	2-3/8	4-1/2	0	1-7/8	5-1/2	0	7/8	-	-	-	10
KB-TZ2 3/4 x 8	8	N	5	4	0	3-3/8	4-1/2	0	2-7/8	5-1/2	0	1-7/8	-	-	-	10
KB-TZ2 3/4 x 9	9	P	6	4	0	4-3/8	4-1/2	0	3-7/8	5-1/2	0	2-7/8	-	-	-	10
KB-TZ2 3/4 x 10	10	R	7	4	0	5-3/8	4-1/2	0	4-7/8	5-1/2	0	3-7/8	-	-	-	10
KB-TZ2 1x6-1/2	6-1/2	K	2 1/2	4 5/8	0	1-1/8	6-3/8	-	-	-	-	-	-	-	-	10
KB-TZ2 1x8	8	N	3 7/8	4 5/8	0	2-5/8	6-3/8	0	7/8	-	-	-	-	-	-	10
KB-TZ2 1x9	9	P	3 7/8	4 5/8	7/8	3-5/8	6-3/8	0	1-7/8	-	-	-	-	-	-	10
KB-TZ2 1x10-1/2	10-1/2	R	6	4 5/8	3/8	5-1/8	6-3/8	0	3-3/8	-	-	-	-	-	-	10
KB-TZ2 1x12	12	T	6	4 5/8	1-7/8	6-5/8	6-3/8	1/8	4-7/8	-	-	-	-	-	-	10

Table 53 – Hilti KB-TZ2 SS304 product portfolio

Description	Length (in)	Length ident. letter	Thread length (in)	Nominal embed. 1 (in)	Min. fixture thickness 1 (in)	Max. fixture thickness 1 (in)	Nominal embed. 2 (in)	Min. fixture thickness 2 (in)	Max. fixture thickness 2 (in)	Nominal embed. 3 (in)	Min. fixture thickness 3 (in)	Max. fixture thickness 3 (in)	Package quantity
KB-TZ2 1/4x2-1/8 SS304	2-1/8	B	7/8	1-3/4	0	1/8	-	-	-	-	-	-	100
KB-TZ2 1/4x2-1/2 SS304	2-1/2	C	1 1/4	1-3/4	0	1/2	-	-	-	-	-	-	100
KB-TZ2 1/4x3-1/4 SS304	3-1/4	D	2	1-3/4	0	1-1/4	-	-	-	-	-	-	100
KB-TZ2 1/4x4-1/2 SS304	4-1/2	G	3	1-3/4	1/8	2-1/2	-	-	-	-	-	-	100
KB-TZ2 3/8x2-1/2 SS304	2-1/2	C	1	1-7/8	0	1/4	-	-	-	-	-	-	50
KB-TZ2 3/8x3 SS304	3	D	1 1/2	1-7/8	0	3/4	2-1/2	0	1/4	-	-	-	50
KB-TZ2 3/8x3-1/2 SS304	3-1/2	Q	2	1-7/8	0	1-1/4	2-1/2	0	3/4	3	0	1/4	50
KB-TZ2 3/8x3-3/4 SS304	3-3/4	E	2 1/4	1-7/8	0	1-1/2	2-1/2	0	1	3	0	1/2	50
KB-TZ2 3/8x5 SS304	5	H	3 1/2	1-7/8	0	2-3/4	2-1/2	0	2-1/4	3	0	1-3/4	50
KB-TZ2 3/8x7 SS304	7	L	4 7/8	1-7/8	1/2	4-3/4	2-1/2	0	4-1/4	3	0	3-3/4	50
KB-TZ2 1/2x3-3/4 SS304	3-3/4	E	1 5/8	2-1/2	0	3/4	3	0	1/4	-	-	-	20
KB-TZ2 1/2x4-1/2 SS304	4-1/2	G	2 3/8	2-1/2	0	1-1/2	3	0	1	3-3/4	0	1/4	20
KB-TZ2 1/2x5-1/2 SS304	5-1/2	I	3 3/8	2-1/2	0	2-1/2	3	0	2	3-3/4	0	1-1/4	20
KB-TZ2 1/2x7 SS304	7	L	4 3/4	2-1/2	1/8	4	3	0	3-1/2	3-3/4	0	2-3/4	20
KB-TZ2 5/8x4-1/4 SS304	4-1/4	F	2 1/4	3-1/4	0	3/8	-	-	-	-	-	-	15
KB-TZ2 5/8x4-3/4 SS304	4-3/4	G	2 3/4	3-1/4	0	7/8	3-3/4	0	3/8	-	-	-	15
KB-TZ2 5/8x6 SS304	6	J	4	3-1/4	0	2-1/8	3-3/4	0	1-5/8	4-1/2	0	7/8	15
KB-TZ2 5/8x7 SS304	7	L	4 7/8	3-1/4	0	3-1/8	3-3/4	0	2-5/8	4-1/2	0	1-7/8	15
KB-TZ2 5/8x8-1/2 SS304	8-1/2	O	6 1/2	3-1/4	0	4-5/8	3-3/4	0	4-1/8	4-1/2	0	3-3/8	15
KB-TZ2 5/8x10 SS304	10	R	7 1/8	3-1/4	1/8	6-1/8	3-3/4	0	5-5/8	4-1/2	0	4-7/8	15
KB-TZ2 3/4x4-3/4 SS304	4-3/4	G	1 3/4	4	0	1/8	-	-	-	-	-	-	10
KB-TZ2 3/4x5-1/2 SS304	5-1/2	I	2 1/2	4	0	7/8	4-1/2	0	3/8	-	-	-	10
KB-TZ2 3/4x6-1/4 SS304	6-1/4	J	3 1/4	4	0	1-5/8	4-1/2	0	1-1/8	5-1/2	0	1/8	10
KB-TZ2 3/4x7 SS304	7	L	4	4	0	2-3/8	4-1/2	0	1-7/8	5-1/2	0	7/8	10
KB-TZ2 3/4x8 SS304	8	N	5	4	0	3-3/8	4-1/2	0	2-7/8	5-1/2	0	1-7/8	10
KB-TZ2 3/4x9 SS304	9	P	6	4	0	4-3/8	4-1/2	0	3-7/8	5-1/2	0	2-7/8	10
KB-TZ2 3/4x10 SS304	10	R	7	4	0	5-3/8	4-1/2	0	4-7/8	5-1/2	0	3-7/8	10
KB-TZ2 3/4x12 SS304	12	T	7	4	1-5/8	7-3/8	4-1/2	1-1/8	6-7/8	5-1/2	1/8	5-7/8	10
KB-TZ2 1x6-1/2 SS304	6-1/2	K	2 1/2	4-5/8	0	7/8	6-3/8	-	-	-	-	-	10
KB-TZ2 1x8 SS304	8	N	3 7/8	4-5/8	0	2-3/8	6-3/8	0	7/8	-	-	-	10
KB-TZ2 1x9 SS304	9	P	3 7/8	4-5/8	1	3-3/8	6-3/8	0	1-7/8	-	-	-	10
KB-TZ2 1x10-1/2 SS304	10-1/2	R	6	4 5/8	1/2	4-7/8	6-3/8	0	3-3/8	-	-	-	10
KB-TZ2 1x12 SS304	12	T	6	4 5/8	2	6-3/8	6-3/8	1/4	4-7/8	-	-	-	10

3.3.5

Table 54 — Hilti KB-TZ2 SS316 product portfolio

Description	Length (in)	Length ident. letter	Thread length (in)	Nominal embed. 1 (in)	Min. fixture thickness 1 (in)	Max. fixture thickness 1 (in)	Nominal embed. 2 (in)	Min. fixture thickness 2 (in)	Max. fixture thickness 2 (in)	Nominal embed. 3 (in)	Min. fixture thickness 3 (in)	Max. fixture thickness 3 (in)	Package quantity
KB-TZ2 1/4x2-1/2 SS316	2-1/2	C	1-1/4	1-3/4	0	1/2	-	-	-	-	-	-	100
KB-TZ2 1/4x3-1/4 SS316	3-1/4	D	2	1-3/4	0	1-1/4	-	-	-	-	-	-	100
KB-TZ2 1/4x4-1/2 SS316	4-1/2	G	3	1-3/4	1/8	2-1/2	-	-	-	-	-	-	100
KB-TZ2 3/8x2-1/2 SS316	2-1/2	C	1	1-7/8	0	1/4	-	-	-	-	-	-	50
KB-TZ2 3/8x3 SS316	3	D	1-1/2	1-7/8	0	3/4	2-1/2	0	1/4	-	-	-	50
KB-TZ2 3/8x3-1/2 SS316	3-1/2	Q	2	1-7/8	0	1-1/4	2-1/2	0	3/4	3	0	1/4	50
KB-TZ2 3/8x3-3/4 SS316	3-3/4	E	2-1/4	1-7/8	0	1-1/2	2-1/2	0	1	3	0	1/2	50
KB-TZ2 3/8x5 SS316	5	H	3-1/2	1-7/8	0	2-3/4	2-1/2	0	2-1/4	3	0	1-3/4	50
KB-TZ2 3/8x7 SS316	7	L	4-7/8	1-7/8	1/2	4-3/4	2-1/2	0	4-1/4	3	0	3-3/4	50
KB-TZ2 1/2x3-3/4 SS316	3-3/4	E	1-5/8	2-1/2	0	3/4	3	0	1/4	-	-	-	20
KB-TZ2 1/2x4-1/2 SS316	4-1/2	G	2-3/8	2-1/2	0	1-1/2	3	0	1	3-3/4	0	1/4	20
KB-TZ2 1/2x5-1/2 SS316	5-1/2	I	3-3/8	2-1/2	0	2-1/2	3	0	2	3-3/4	0	1-1/4	20
KB-TZ2 1/2x7 SS316	7	L	4-3/4	2-1/2	1/8	4	3	0	3-1/2	3-3/4	0	2-3/4	20
KB-TZ2 1/2x8-1/2 SS316	8-1/2	O	4-7/8	2-1/2	1-1/2	5-1/2	3	1	5	3-3/4	1/4	4-1/4	20
KB-TZ2 1/2x10 SS316	10	R	4-7/8	2-1/2	3	7	3	2-1/2	6-1/2	3-3/4	1-3/4	5-3/4	20
KB-TZ2 5/8x4-1/4 SS316	4-1/4	F	2-1/4	3-1/4	0	3/8	-	-	-	-	-	-	15
KB-TZ2 5/8x4-3/4 SS316	4-3/4	G	2-3/4	3-1/4	0	7/8	3-3/4	0	3/8	-	-	-	15
KB-TZ2 5/8x6 SS316	6	J	4	3-1/4	0	2-1/8	3-3/4	0	1-5/8	4-1/2	0	7/8	15
KB-TZ2 5/8x7 SS316	7	L	4-7/8	3-1/4	0	3-1/8	3-3/4	0	2-5/8	4-1/2	0	1-7/8	15
KB-TZ2 5/8x8-1/2 SS316	8-1/2	O	6-1/2	3-1/4	0	4-5/8	3-3/4	0	4-1/8	4-1/2	0	3-3/8	15
KB-TZ2 5/8x10 SS316	10	R	7-1/8	3-1/4	1/8	6-1/8	3-3/4	0	5-5/8	4-1/2	0	4-7/8	15
KB-TZ2 3/4x4-3/4 SS316	4-3/4	G	1-3/4	4	0	1/8	-	-	-	-	-	-	10
KB-TZ2 3/4x5-1/2 SS316	5-1/2	I	2-1/2	4	0	7/8	4-1/2	0	3/8	-	-	-	10
KB-TZ2 3/4x6-1/4 SS316	6-1/4	J	3-1/4	4	0	1-5/8	4-1/2	0	1-1/8	5-1/2	0	1/8	10
KB-TZ2 3/4x7 SS316	7	L	4	4	0	2-3/8	4-1/2	0	1-7/8	5-1/2	0	7/8	10
KB-TZ2 3/4x8 SS316	8	N	5	4	0	3-3/8	4-1/2	0	2-7/8	5-1/2	0	1-7/8	10
KB-TZ2 3/4x9 SS316	9	P	6	4	0	4-3/8	4-1/2	0	3-7/8	5-1/2	0	2-7/8	10
KB-TZ2 3/4x10 SS316	10	R	7	4	0	5-3/8	4-1/2	0	4-7/8	5-1/2	0	3-7/8	10
KB-TZ2 3/4x12 SS316	12	T	7	4	1-5/8	7-3/8	4-1/2	1-1/8	6-7/8	5-1/2	1/8	5-7/8	10

Figure 9 — Anchor head with length identification code and KB-TZ2 head notch embossment

