

ICC-ES Evaluation Report

ESR-2197

Reissued December 2023

This report also contains:

- LABC Supplement

Subject to renewal December 2025

- FBC Supplement

ICC-ES Evaluation Reports are not to be construed as representing aesthetics or any other attributes not specifically addressed, nor are they to be construed as an endorsement of the subject of the report or a recommendation for its use. There is no warranty by ICC Evaluation Service, LLC, express or implied, as to any finding or other matter in this report, or as to any product covered by the report.

Copyright © 2024 ICC Evaluation Service, LLC. All rights reserved.

<p>DIVISION: 05 00 00— METALS</p> <p>Section: 05 05 23— Metal Fastenings</p> <p>Section: 05 31 00— Steel Decking</p>	<p>REPORT HOLDER: HILTI, INC.</p>	<p>EVALUATION SUBJECT: BARE STEEL DECK AND CONCRETE- FILLED STEEL DECK DIAPHRAGMS ATTACHED WITH HILTI X-HSN 24 OR X-ENP-19 L15 POWDER-DRIVEN FRAME FASTENERS</p>	
---	--	---	---

1.0 EVALUATION SCOPE

Compliance with the following codes:

- 2021, 2018, 2015 and 2012 [International Building Code® \(IBC\)](#)

For evaluation for compliance with codes adopted by the [Los Angeles Department of Building and Safety \(LADBS\)](#), see [ESR-2197 LABC Supplement](#).

Property evaluated:

Structural

2.0 USES

Hilti X-HSN 24 and X-ENP-19 L15 powder-driven frame fasteners are used for the attachment of bare steel deck and concrete-filled steel deck diaphragms to structural steel members.

3.0 DESCRIPTION

3.1 Power-driven Fasteners:

The Hilti fasteners are manufactured from hardened carbon steel with an electroplated zinc coating conforming to ASTM B633-07, SC 1, Type III.

The X-HSN 24 fasteners are manufactured from hardened carbon steel with an electroplated zinc coating complying with ASTM B633, SC 1, Type III. The fasteners are 0.960 inch (24.4 mm) long, with a 0.157-inch-diameter (4.0 mm), fully knurled tip and tapered shank. The X-HSN 24 fasteners have a dome-style head and a premounted 0.472-inch-diameter (12 mm) steel top hat washer with red plastic collation strip. See [Table 1](#) for fastener drawings.

The X-ENP-19 L15 fasteners are 0.937 inch (23.8 mm) long with a 0.177-inch-diameter (4.5 mm) knurled, tapered shank fitted with two 0.590-inch-diameter (15.0 mm) steel cupped washers. The X-ENP-19 L15 fasteners have a flattened head design to accept a sealing cap. See [Table 1](#) for fastener drawings.

3.2 Steel Deck Panels:

Bare steel and concrete-filled decks must have nominally 1¹/₂-, 2- or 3-inch-deep flutes and must have nestable-type or interlocking-type (standing seam) sidelaps. The decks must conform to the requirements of ASTM A653 SS, Grade 33 (minimum), with minimum G60 galvanized coating. Bare steel decks may also be

painted or phosphatized steel complying with ASTM A1008 SS, Grade 33 (minimum). Concrete-filled steel decks must have deck embossments or indentations for positive interlock with concrete fill.

The 1½-inch-deep (38 mm) steel deck panels must have minimum base-steel thicknesses of 0.0598, 0.0474, 0.0358 or 0.0295 inch (1.52, 1.19, 0.91 or 0.76 mm) [59, 47, 35 or 29 mils (No. 16, 18, 20 or 22 gage)]. The steel deck panels must have a width of 36 inches (914 mm) with flutes spaced 6 inches (152 mm) on center.

The 2-inch-deep (51 mm) steel deck panels must have minimum base-steel thicknesses of 0.0598, 0.0474, 0.0418 or 0.0358 inch (1.52, 1.19, 1.06 or 0.91 mm) [59, 47, 41 or 35 mils (No. 16, 18, 19 or 20 gage)]. The steel deck panels must have a width of 36 inches (914 mm) with flutes spaced 12 inches (305 mm) on center.

The 3-inch-deep (76 mm) steel deck panels must have minimum base-steel thicknesses of 0.0478, 0.0418, 0.0359 or 0.0299 inch (1.21, 1.06, 0.91 or 0.76 mm) [47, 41, 35 or 29 mils (No. 18, 19, 20 or 22 gage)]. The steel deck panels must have widths of 24 or 36 inches (610 and 914 mm), with flutes spaced 8 or 12 inches (203 and 305 mm) on center, respectively.

3.3 Concrete Fill:

Concrete fill must be either normal weight [145 lb/ft³ (2323 kg/m³)] or lightweight [110 lb/ft³ (1782 kg/m³)] with aggregate conforming to ASTM C33 or ASTM C330, and have a minimum 28-day compressive strength, f'_c , of 3,000 psi (20.7 MPa). Concrete fill must be specified in accordance with the applicable code.

3.4 Reinforcement (Temperature and Shrinkage):

For the 2021 IBC, welded plain wire reinforcement must comply with ASTM A1064-18a (see ACI 318-19).

For the 2018 and 2015 IBC, welded plain wire reinforcement must comply with ASTM A1064-13 (see ACI 318-14).

For the 2012 IBC, welded plain wire reinforcement must comply with ASTM A1064-10 (see ACI 318-11).

For the 2009, welded plain wire reinforcement must consist of plain wires conforming to ASTM A82-07 fabricated into sheets in accordance with ASTM A185-07 (see ACI 318-08).

Wire must be embedded 1 inch (25.4 mm) from the top surface of the concrete slab.

3.5 Sealing Cap:

The Hilti SDK2 sealing cap is made from SAE 316 stainless steel with a neoprene washer, and is intended to be installed over the flattened head of the X-ENP-19 L15 fastener. [Figure 4](#) depicts the Hilti SDK2 sealing cap.

3.6 Sidelap Screws:

The screws for steel deck panel sidelap connections must be minimum No. 10 by ¾-inch-long (19.1 mm), HWH or HHWH, self-drilling steel screws conforming to ASTM C1513 requirements and manufactured by Hilti, Inc. These fasteners are recognized in ICC-ES evaluation report [ESR-2196](#).

3.7 Supports:

Structural steel supports must comply with the minimum strength requirements of ASTM A36, ASTM A572 Grade 50, or ASTM A992. See [Table 1](#) for applicable thicknesses of structural steel supports used with Hilti powder-driven frame fasteners.

4.0 DESIGN AND INSTALLATION

4.1 Design:

Design information for steel deck panels attached to structural steel supports with Hilti X-HSN 24 and X-ENP-19 L15 fasteners is found in the tables of this report.

[Table 1](#) provides guidance for determining the proper fastener.

The required number and placement of fasteners for various spans with allowable diaphragm shears, q , and flexibility factors, F , are shown in [Tables 3](#) through [6](#) for bare-steel deck diaphragms, and in [Tables 8](#) and [9](#) for concrete-filled steel deck diaphragms.

Nominal shear and flexibility factors for the fasteners are provided in [Table 11](#).

Allowable uplift loads for fasteners must be the lower of the allowable pullout and pullover strengths provided in [Tables 12](#) and [13, respectively](#).

The notes after [Table 13](#) describe additional design requirements and limitations.

Allowable diaphragm shear values in [Tables 3](#) through [6](#) are for bare-steel deck diaphragms subjected to earthquake loads or subjected to load combinations which include earthquake loads.

Allowable diaphragm shear values found in [Tables 3](#) through [6](#) must also be limited to the respective ASD and LRFD buckling diaphragm capacities found in [Table 7](#).

The diaphragm shear values in [Tables 3](#) through [6](#) may be increased for other applications as follows:

DESIGN METHOD	FOR	MULTIPLY DIAPHRAGM SHEARS IN TABLE BY
ASD	Bare deck diaphragms subjected to wind loads or load combinations which include wind loads, $\Omega_{df} = 2.00$	1.15
ASD	Bare deck diaphragms subject to earthquake and all other load combinations, $\Omega_{df} = 2.30$	1.00
LRFD	Bare deck diaphragms subjected to earthquake loads and all other load combinations, $\phi_{df} = 0.70$	1.61
LRFD	Bare deck diaphragms subjected to wind loads or load combinations which include wind loads, $\phi_{df} = 0.80$	1.84
ASD	Concrete-filled diaphragms subjected to wind, earthquake or other load combinations, $\Omega_{df} = 3.25$	1.00
LRFD	Concrete-filled diaphragms subjected to wind, earthquake or other load combinations, $\phi_{df} = 0.50$	1.63

Allowable strength design (ASD) diaphragm capacities in [Tables 8](#) and [9](#) are for concrete-filled steel deck diaphragms subjected to earthquake loads or subjected to load combinations which include earthquake loads. For LRFD diaphragm capacities, the tabulated “ q ” value must be multiplied by 1.60.

4.2 Installation:

Frame fastener selection must be in accordance with [Table 1](#). Figures and tables are summarized in the table of contents that appears following the text of this report. Standing seam interlocking-type sidelaps must be well engaged, and the button-punching sharp and deep. The coating of the outer protruding nose of the punched lap should be “starred,” indicating a near-penetration of the button punching tool.

5.0 CONDITIONS OF USE:

The bare steel deck and concrete-filled steel deck diaphragms attached with Hilti X-HSN 24 or X-ENP-19 L15 powder driven fasteners, as described in this report, comply with, or are suitable alternatives to what is specified in, those codes listed in Section 1.0 of this report, subject to the following conditions:

- 5.1 The fasteners are manufactured, identified and installed in accordance with this report, the manufacturer’s instructions and the approved plans. If there is a conflict, this report governs.
- 5.2 The base metal thickness for deck panels delivered to the jobsite must be a least 95% of the design base metal thickness.
- 5.3 Special inspections must comply with IBC Chapter 17.
- 5.4 Steel deck and concrete-filled steel deck diaphragm construction must comply with this report.
- 5.5 Calculations demonstrating that the applied loads do not exceed the capacities in this report must be submitted to the code official for approval. The calculations must be prepared by a registered design professional where required by the statutes of the jurisdiction in which the project is to be constructed.
- 5.6 The Diaphragm Flexibility Limitations in [Table 14](#) must be considered, as applicable.
- 5.7 Concrete-filled steel decks panels must not be used to support loads that are predominantly vibratory, such as those for operation of heavy machinery, reciprocating motors and moving loads.
- 5.8 Fasteners are manufactured by Hilti, Inc. in Schaan, Liechtenstein, under a quality control program with annual inspections by ICC-ES.

- 5.9 When the steel deck panels are used as roof decks, the panels must be covered with an approved code-complying roof covering.
- 5.10 Hilti fasteners may be used for attachment of steel deck roof and floor systems temporarily exposed to the exterior during construction prior to application of a built-up roof covering system or concrete fill. The fasteners on permanently exposed steel deck roof coverings must be covered with a corrosion-resistant paint or sealant. As an alternate to applying a corrosion-resistant paint or sealant to the X-ENP-19 L15 fasteners, these fasteners may be used in conjunction with the SDK2 Stainless Steel Sealing Caps, described in Section 3.6 of this report, on permanently exposed steel deck roof coverings. For permanently exposed steel deck roof covering installations, the roof covering system's compliance with Chapter 15 of the code must be justified to the satisfaction of the code official.

6.0 EVIDENCE SUBMITTED

- 6.1 Data in accordance with the [ICC-ES Acceptance Criteria for Steel Deck Roof and Floor Systems \(AC43\)](#), dated August 2022.
- 6.2 Data in accordance with the [ICC-ES Acceptance Criteria for Power-actuated Fasteners Driven into Concrete, Steel and Masonry Elements \(AC70\)](#), dated December 2019 (editorially revised January 2021).

7.0 IDENTIFICATION

- 7.1 The Hilti X-HSN 24 and X-ENP-19 L15 fasteners are identified by an "H" stamped on the fastener head. Fasteners are packaged in containers noting the fastener type, the Hilti, Inc., name and address, and the evaluation report number (ESR-2197).
- 7.2 The report holder's contact information is the following:

HILTI, INC.
7250 DALLAS PARKWAY, SUITE 1000
PLANO, TEXAS 75024
(800) 879-8000
www.hilti.com/decking
deck@hilti.com

TABLE	TABLE OF CONTENTS	PAGE
1	Table 1 —Frame Fastener Selector Guide for the X-HSN 24 and X-ENP-19 L15 fasteners	5
2	Table 2 – Safety Factors for Allowable Strength Design (ASD) and Resistance Factors for Load and Resistance Factor Design (LRFD) in Accordance with AISI S310	5
ALLOWABLE DIAPHRAGM SHEARS AND FLEXIBILITY FACTORS FOR BARE DECKS		
3 & 4	1 ¹ / ₂ -inch-deep decks with 6-inch on center flutes Hilti X-HSN 24 frame fasteners (36/4, 36/7, 36/9 and 36/11 patterns) Minimum No. 10 Screw Sidelaps	6 & 7
5	1 ¹ / ₂ -inch-deep decks with 6-inch on center flutes Hilti X-ENP-19 L15 frame fasteners (36/7, 36/9, and 36/11 patterns) Minimum No. 10 Screw Sidelaps	8
6	3-inch-deep decks with 8-inch on center flutes Hilti X-ENP-19 L15 frame fasteners (24/4 pattern) Minimum No. 10 Screw Sidelaps	9
ALLOWABLE DIAPHRAGM SHEARS BASED ON STABILITY		
7	1 ¹ / ₂ -inch deep decks with 6-inch on center flutes and 3-inch deep decks with 8-inch on center flutes	10
ALLOWABLE DIAPHRAGM SHEARS AND FLEXIBILITY FACTORS FOR CONCRETE FILLED DECKS		
8	1 ¹ / ₂ -inch-deep decks with 6-inch on center flutes Normal and Lightweight Concrete (2 ¹ / ₂ " to 5 ¹ / ₂ " topping thicknesses) Hilti X-HSN 24 or X-ENP-19 L15 frame fasteners (36/4 pattern) Button Punch Sidelaps	11
9	2- or 3-inch-deep decks with 12-inch on center flutes Normal and Lightweight Concrete (2" to 5" topping thicknesses) Hilti X-HSN 24 or X-ENP-19 L15 frame fasteners (36/4 pattern) Button Punch Sidelaps	12
MISCELLANEOUS		
10	Deck types for concrete-filled diaphragms	13
11	Nominal shear P_{nt} , and Flexibility Factors, S_f , for steel deck attached with X-HSN 24 or X-ENP-19 L15 fasteners	14
12	Allowable (ASD) Tension Pullout loads to resist Tension (uplift) loads for steel decks attached with X-HSN 24 or X-ENP-19 L15 fasteners	14
13	Allowable (ASD) Tension Pullover loads to resist Tension (uplift) loads for steel decks attached with X-HSN 24 or X-ENP-19 L15 fasteners	14
Footnotes to Tables 3 through 18		
14	Diaphragm Flexibility Limitation	16
FIGURE		
1	1 ¹ / ₂ " B Deck – 36" Wide (Type A)	13
2	2" Deck – 36" Wide (Type B)	13
3	3" Deck – 36" Wide (Type C)	13
4	SDK2 Stainless Steel Sealing Cap	14
5	Nail Head Standoff (h_{NVS}) for X-ENP-19 L15 fasteners	15
6	Nail Head Standoff (h_{NVS}) for X-HSN 24 fasteners	15

TABLE 1—FRAME FASTENER SELECTOR GUIDE

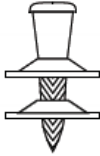
Base Material ^{1,2}	Fastener Type	Reference Tables	
		Bare Steel Deck Diaphragm	Concrete Filled Diaphragm
Bar Joist or Structural Steel Shape with $\frac{1}{8}$ in. $\leq t_f \leq \frac{3}{8}$ in.	 X-HSN 24	Tables 3.4.7	Tables 8.9
Structural Steel, Hardened Structural Steel or Heavy Bar Joist with $t_f \geq \frac{1}{4}$ in.	 X-ENP-19 L15 ²	Tables 5.6.7	Tables 8.9

For SI: 1 inch = 25.4 mm.

¹ t_f = Structural framing minimum uncoated base metal thickness. Steel base material tensile strength (F_u) must range from 58 to 91 ksi for all fasteners and base steel thickness combinations, except for the X-HSN 24 fastener with steel thicknesses greater than $\frac{5}{16}$ inch. In this case, the tensile strength for the X-HSN 24 fastener must range from 58 to 75 ksi. Base metal must comply with minimum strength requirements of ASTM A36.

²Reference [Figure 4](#) for information regarding the use of the SDK2 sealing cap.

TABLE 2—SAFETY FACTORS FOR AVAILABLE SHEAR STRENGTH (ASD) AND RESISTANCE FACTORS FOR FACTORED RESISTANCE (LRFD)^{1,2}

LOAD TYPE OR COMBINATIONS INCLUDING	CONNECTION TYPE		Ω_{df} (ASD)	ϕ_{df} (LRFD)
	FRAME	SIDELAP		
Wind	X-HSN 24, or X-ENP-19 L15	Minimum No.10 Screws or Button Punch	2.00	0.800
Earthquake and all others			2.30	0.700
Wind		Decking with Concrete Fill	3.25	0.500
Earthquake and all others			3.25	0.500

¹For bare decks, [Tables 3 - 6](#) include the available diaphragm shear strength for earthquake and all other load combinations (i.e. $\Omega_{df} = 2.30$). The available diaphragm shear strength or factored diaphragm shear resistance must be the lesser of:

- [Tables 3 - 6](#) values applying the appropriate multiplier per Section 4.1 and
- [Table 7](#) values for buckling.

²For concrete filled decks, [Tables 8 and 9](#) include available shear strength for wind, earthquake, and all other load combinations (i.e. $\Omega_{df} = 3.25$). The factored shear resistance is determined by applying the multiplier in Section 4.1.

TABLE 3—ALLOWABLE DIAPHRAGM SHEARS, S_{nf}/Ω_{nf} (plf) AND FLEXIBILITY FACTORS, F (micro-inches/lb)^{1,2}
 (F = 1000/G') where the diaphragm stiffness (G') is in kips/in

DECK: 1½ -INCH DEEP, 6-INCH ON CENTER FLUTES (see figures below)

FRAME FASTENERS: HILTI X-HSN 24 (see applicable patterns below)

SIDLAP CONNECTIONS: MINIMUM No. 10 SELF-DRILLING SCREW (see Section 3.6)

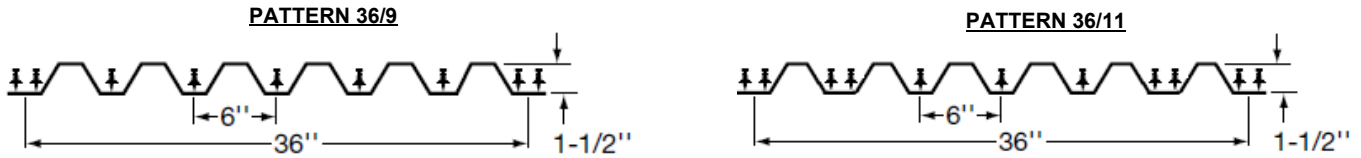

GAGE	SIDELAP CONNECTION	FACTOR	SPAN (FT-IN.)													
			4'-0"		5'-0"		6'-0"		7'-0"		8'-0"		9'-0"		10'-0"	
			FASTENERS PER SHEET TO SUPPORT													
			9	11	9	11	9	11	9	11	9	11	9	11	9	11
22	Screws @ 12" o.c.	S_{nf}/Ω_{nf}	659	762	576	658	516	582	465	520	426	474	398	440	376	415
		F	15.6	15.3	14.1	13.9	13.2	12.9	12.6	12.3	12.2	11.9	11.8	11.5	11.6	11.3
	Screws @ 8" o.c.	S_{nf}/Ω_{nf}	723	831	645	732	589	662	547	610	515	565	489	531	467	505
		F	15.1	14.9	13.6	13.4	12.5	12.3	11.8	11.6	11.3	11.1	10.9	10.7	10.6	10.4
	Screws @ 6" o.c.	S_{nf}/Ω_{nf}	782	896	710	802	658	735	619	686	588	647	564	617	544	592
		F	14.8	14.6	13.1	13.0	12.1	11.9	11.3	11.2	10.8	10.6	10.3	10.2	10.0	9.9
20	Screws @ 12" o.c.	S_{nf}/Ω_{nf}	812	937	713	813	642	725	588	654	541	598	504	555	477	524
		F	11.2	11.0	10.4	10.2	9.9	9.7	9.6	9.4	9.4	9.1	9.2	9.0	9.1	8.9
	Screws @ 8" o.c.	S_{nf}/Ω_{nf}	896	1028	804	910	738	827	689	765	650	718	620	676	595	645
		F	10.8	10.6	9.9	9.7	9.3	9.1	8.9	8.7	8.6	8.5	8.4	8.2	8.2	8.1
	Screws @ 6" o.c.	S_{nf}/Ω_{nf}	972	1113	888	1003	827	924	781	865	746	820	718	784	694	755
		F	10.5	10.4	9.5	9.4	8.9	8.8	8.5	8.3	8.1	8.0	7.9	7.8	7.7	7.6
18	Screws @ 12" o.c.	S_{nf}/Ω_{nf}	1099	1266	973	1106	882	993	814	910	762	841	717	784	678	739
		F	7.3	7.1	7.0	6.8	6.9	6.7	6.8	6.6	6.8	6.5	6.7	6.5	6.7	6.5
	Screws @ 8" o.c.	S_{nf}/Ω_{nf}	1222	1401	1107	1251	1024	1145	962	1067	914	1006	875	958	844	918
		F	6.9	6.8	6.6	6.4	6.3	6.2	6.2	6.0	6.1	5.9	6.0	5.9	5.9	5.8
	Screws @ 6" o.c.	S_{nf}/Ω_{nf}	1333	1526	1229	1387	1154	1288	1097	1214	1053	1157	1018	1112	989	1075
		F	6.7	6.6	6.3	6.2	6.0	5.9	5.8	5.7	5.7	5.6	5.6	5.5	5.5	5.4

For SI: 1 inch = 25.4 mm, 1 foot = 305 mm, 1 plf = 14.6 N/m, 1 psi = 6.89 kPa, 1inch/lb = 5.7 mm/N.

¹Refer to footnotes following Table 13 for additional installation and design requirements.

²Allowable stress design diaphragm capacities are presented for diaphragms mechanically connected to the structure subjected to earthquake loads or load combinations which include earthquake loads. Diaphragm shears may be increased for other applications as prescribed in Section 4.1 of this report.

TABLE 4—ALLOWABLE DIAPHRAGM SHEARS, S_{nf}/Ω_{nf} (plf) AND FLEXIBILITY FACTORS, F (micro-inches/lb)^{1,2}

DECK: 1 1/2 -INCH DEEP, 6-INCH ON CENTER FLUTES (see figure below)

FRAME FASTENERS: HILTI X-HSN 24 (see applicable pattern below)

SIDLAP CONNECTIONS: MINIMUM No. 10 SELF-DRILLING SCREW (see Section 3.6)

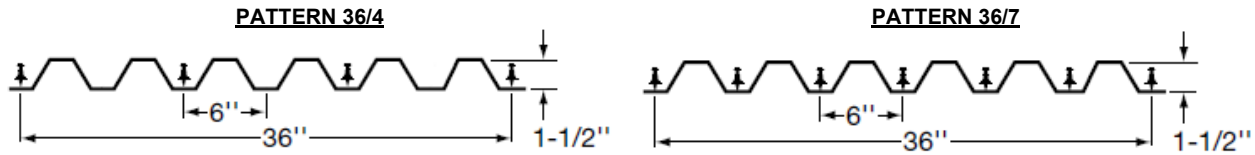

GAGE	SIDELAP CONNECTION	FACTOR	SPAN (FT - IN.)													
			4'-0"		5'-0"		6'-0"		7'-0"		8'-0"		9'-0"		10'-0"	
			FASTENERS PER SHEET TO SUPPORT													
			4	7	4	7	4	7	4	7	4	7	4	7	4	7
22	Screws @ 12" o.c.	S_{nf}/Ω_{nf}	353	480	323	425	302	387	286	358	273	334	263	316	255	303
		F	82.0	16.2	67.6	14.7	57.8	13.8	50.8	13.1	45.7	12.7	41.7	12.3	38.5	12.0
	Screws @ 8" o.c.	S_{nf}/Ω_{nf}	402	550	377	499	359	463	346	437	335	417	327	401	320	388
		F	81.3	15.5	66.2	13.9	56.5	12.9	49.8	12.1	44.4	11.6	40.3	11.2	37.2	10.8
	Screws @ 6" o.c.	S_{nf}/Ω_{nf}	441	615	421	568	407	534	396	510	387	491	380	476	374	464
		F	80.6	15.0	65.8	13.4	55.9	12.3	49.0	11.5	43.7	10.9	39.7	10.5	36.4	10.1
20	Screws @ 12" o.c.	S_{nf}/Ω_{nf}	439	598	405	532	380	487	361	453	347	428	335	405	326	389
		F	52.4	11.8	43.7	11.0	37.7	10.4	33.4	10.1	30.4	9.9	27.9	9.7	26.0	9.6
	Screws @ 8" o.c.	S_{nf}/Ω_{nf}	501	690	473	629	453	587	438	556	426	532	416	514	409	498
		F	51.5	11.1	42.6	10.2	36.6	9.6	32.4	9.2	29.2	8.9	26.7	8.6	24.7	8.5
	Screws @ 6" o.c.	S_{nf}/Ω_{nf}	550	773	528	718	512	680	500	651	490	629	482	612	476	598
		F	51.0	10.7	42.0	9.7	36.1	9.1	31.7	8.6	28.5	8.3	26.0	8.0	24.0	7.8
18	Screws @ 12" o.c.	S_{nf}/Ω_{nf}	603	823	561	739	531	681	508	638	490	606	476	580	464	559
		F	28.2	7.8	23.9	7.5	21.0	7.3	19.0	7.2	17.5	7.2	16.3	7.1	15.4	7.1
	Screws @ 8" o.c.	S_{nf}/Ω_{nf}	689	957	656	882	633	829	615	790	601	760	590	737	581	717
		F	27.4	7.2	23.0	6.8	20.1	6.6	18.0	6.4	16.4	6.3	15.2	6.2	14.3	6.1
	Screws @ 6" o.c.	S_{nf}/Ω_{nf}	754	1078	729	1010	711	963	698	928	687	901	678	879	671	862
		F	27.0	6.9	22.5	6.4	19.6	6.2	17.5	6.0	15.9	5.8	14.6	5.7	13.7	5.6

For SI: 1 inch = 25.4 mm, 1 foot = 305 mm, 1 plf = 14.6 N/m, 1 psi = 6.89 kPa, 1 inch/lb = 5.7 mm/N.

¹Refer to footnotes following Table 13 for additional installation and design requirements.

²Allowable stress design diaphragm capacities are presented for diaphragms mechanically connected to the structure subjected to earthquake loads or load combinations which include earthquake loads. Diaphragm shears may be increased for other applications as prescribed in Section 4.1 of this report.

TABLE 5—ALLOWABLE DIAPHRAGM SHEARS, S_{nf}/Ω_{nf} (plf) AND FLEXIBILITY FACTORS, F (micro-inches/lb)^{1,2}

DECK: 1½ -INCH DEEP, 6-INCH ON CENTER FLUTES (see figures below)

FRAME FASTENERS: HILTI X-ENP-19 L15 (see applicable patterns below)

SIDLAP CONNECTIONS: MINIMUM No. 10 SELF-DRILLING SCREW (see Section 3.6)

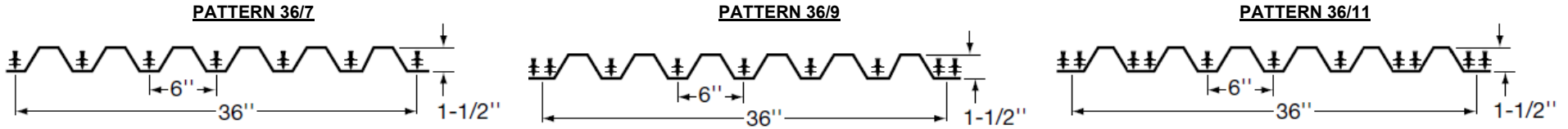

GAGE	SIDELAP CONNECTION	FACTOR	SPAN (FT - IN.)																				
			4'-0"			5'-0"			6'-0"			7'-0"			8'-0"			9'-0"			10'-0"		
			FASTENERS PER SHEET TO SUPPORT																				
			7	9	11	7	9	11	7	9	11	7	9	11	7	9	11	7	9	11	7	9	11
22	Screws @ 12" o.c.	S_{nf}/Ω_{nf}	506	700	810	446	609	697	404	543	612	371	487	546	345	445	496	327	414	460	312	391	432
		F	15.5	14.9	14.6	14.0	13.4	13.2	13.1	12.5	12.2	12.5	11.9	11.6	12.0	11.4	11.1	11.7	11.1	10.8	11.4	10.9	10.6
	Screws @ 8" o.c.	S_{nf}/Ω_{nf}	577	764	879	521	679	771	482	618	695	453	572	637	431	535	587	413	505	551	399	482	523
		F	15.0	14.6	14.4	13.4	13.1	12.9	12.4	12.0	11.9	11.7	11.4	11.2	11.2	10.8	10.7	10.8	10.5	10.3	10.5	10.2	10.0
	Screws @ 6" o.c.	S_{nf}/Ω_{nf}	643	825	945	591	745	842	554	688	770	527	645	715	507	611	674	490	585	640	477	563	614
		F	14.7	14.4	14.3	13.1	12.8	12.7	12.0	11.7	11.6	11.3	11.0	10.9	10.7	10.5	10.3	10.3	10.0	9.9	9.9	9.7	9.6
20	Screws @ 12" o.c.	S_{nf}/Ω_{nf}	629	861	995	558	753	860	508	676	765	472	615	686	442	564	626	418	524	579	400	495	545
		F	11.1	10.6	10.4	10.3	9.8	9.5	9.8	9.3	9.0	9.5	9.0	8.7	9.3	8.7	8.5	9.1	8.6	8.3	9.0	8.5	8.2
	Screws @ 8" o.c.	S_{nf}/Ω_{nf}	722	946	1087	656	845	958	610	773	868	576	719	801	550	677	747	529	644	700	513	617	666
		F	10.7	10.3	10.2	9.8	9.5	9.3	9.2	8.9	8.7	8.8	8.5	8.3	8.5	8.2	8.0	8.3	8.0	7.8	8.1	7.9	7.7
	Screws @ 6" o.c.	S_{nf}/Ω_{nf}	808	1024	1173	747	931	1052	704	864	966	673	814	902	649	775	852	630	743	813	614	718	781
		F	10.4	10.2	10.0	9.5	9.2	9.1	8.8	8.6	8.5	8.4	8.2	8.0	8.1	7.9	7.7	7.8	7.6	7.5	7.6	7.4	7.3
18	Screws @ 12" o.c.	S_{nf}/Ω_{nf}	864	1164	1342	773	1026	1168	710	927	1046	663	853	955	627	796	877	599	744	816	577	702	767
		F	7.2	6.8	6.6	6.9	6.5	6.2	6.8	6.3	6.1	6.7	6.2	6.0	6.6	6.2	5.9	6.6	6.2	5.9	6.6	6.2	5.9
	Screws @ 8" o.c.	S_{nf}/Ω_{nf}	1001	1289	1479	918	1162	1315	860	1071	1199	817	1003	1113	784	950	1047	758	908	995	737	874	952
		F	6.9	6.5	6.4	6.5	6.2	6.0	6.3	6.0	5.8	6.1	5.8	5.7	6.0	5.7	5.6	5.9	5.7	5.5	5.9	5.6	5.5
	Screws @ 6" o.c.	S_{nf}/Ω_{nf}	1125	1403	1606	1050	1288	1453	998	1204	1344	959	1141	1263	929	1093	1201	905	1054	1151	885	1022	1110
		F	6.6	6.4	6.3	6.2	6.0	5.9	5.9	5.7	5.6	5.7	5.5	5.4	5.6	5.4	5.3	5.5	5.3	5.2	5.4	5.3	5.2

For SI: 1 inch = 25.4 mm, 1 foot = 305 mm, 1 plf = 14.6 N/m, 1 psi = 6.89 kPa, 1inch/lb = 5.7 mm/N.

¹Refer to footnotes following Table 13 for additional installation and design requirements.

²Allowable stress design diaphragm capacities are presented for diaphragms mechanically connected to the structure subjected to earthquake loads or load combinations which include earthquake loads. Diaphragm shears may be increased for other applications as prescribed in Section 4.1 of this report.

TABLE 6—ALLOWABLE DIAPHRAGM SHEARS, S_{nf}/Ω_{nf} (plf) AND FLEXIBILITY FACTORS, F (micro-inches/lb)^{1,2}

DECK: 3-INCH DEEP, 8-INCH ON CENTER FLUTES (see figure below)

FRAME FASTENERS: HILTI X-ENP-19 L15 (see applicable pattern below)

SIDELAP CONNECTIONS: MINIMUM No. 10 SELF-DRILLING SCREW (see Section 3.6)

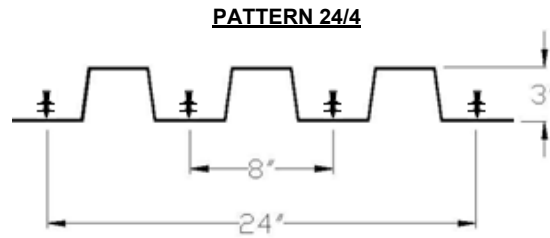

GAGE	SIDELAP CONNECTION	FACTOR	SPAN (FT – IN.)								
			7'-0"	8'-0"	9'-0"	10'-0"	11'-0"	12'-0"	13'-0"	14'-0"	15'-0"
			FASTENERS PER SHEET TO SUPPORT								
			4	4	4	4	4	4	4	4	4
22	Screws @ 12" o.c.	S_{nf}/Ω_{nf}	309	293	281	271	263	256	250	245	241
		F	40.3	36.8	34.1	32.1	30.3	28.8	27.6	26.6	25.7
	Screws @ 8" o.c.	S_{nf}/Ω_{nf}	390	375	363	353	346	339	333	328	324
		F	38.8	35.2	32.5	30.3	28.5	27.0	25.7	24.6	23.7
	Screws @ 6" o.c.	S_{nf}/Ω_{nf}	459	445	434	426	419	413	407	403	399
		F	37.9	34.4	31.5	29.2	27.4	25.9	24.6	23.5	22.5
20	Screws @ 12" o.c.	S_{nf}/Ω_{nf}	396	377	362	350	341	332	325	320	314
		F	27.5	25.4	23.9	22.6	21.6	20.7	20.0	19.4	18.9
	Screws @ 8" o.c.	S_{nf}/Ω_{nf}	498	480	467	455	446	438	432	426	421
		F	26.2	24.0	22.4	21.1	20.0	19.0	18.3	17.6	17.1
	Screws @ 6" o.c.	S_{nf}/Ω_{nf}	587	571	559	549	541	534	528	523	518
		F	25.4	23.2	21.5	20.1	19.0	18.1	17.3	16.6	16.0
18	Screws @ 12" o.c.	S_{nf}/Ω_{nf}	566	541	522	507	494	483	474	466	459
		F	16.6	15.7	14.9	14.4	13.9	13.6	13.3	13.0	12.8
	Screws @ 8" o.c.	S_{nf}/Ω_{nf}	710	689	672	658	646	637	628	621	615
		F	15.5	14.5	13.7	13.0	12.5	12.1	11.8	11.4	11.2
	Screws @ 6" o.c.	S_{nf}/Ω_{nf}	837	819	804	792	781	773	766	760	754
		F	14.8	13.7	12.9	12.3	11.7	11.3	10.9	10.6	10.3
16	Screws @ 12" o.c.	S_{nf}/Ω_{nf}	756	727	704	685	670	656	645	636	628
		F	11.5	11.1	10.7	10.5	10.2	10.1	9.9	9.8	9.7
	Screws @ 8" o.c.	S_{nf}/Ω_{nf}	953	927	907	891	877	866	856	848	840
		F	10.5	10.0	9.6	9.2	9.0	8.7	8.6	8.4	8.3
	Screws @ 6" o.c.	S_{nf}/Ω_{nf}	1121	1099	1082	1068	1056	1047	1038	1031	1025
		F	9.9	9.3	8.9	8.5	8.2	8.0	7.8	7.6	7.5

For SI: 1 inch = 25.4 mm, 1 foot = 305 mm, 1 plf = 14.6 N/m, 1 psi = 6.89 kPa, 1inch/lb = 5.7 mm/N.

¹Refer to footnotes following Table 13 for additional installation and design requirements.

²Allowable stress design diaphragm capacities are presented for diaphragms mechanically connected to the structure subjected to earthquake loads or load combinations which include earthquake loads. Diaphragm shears may be increased for other applications as prescribed in Section 4.1 of this report.

TABLE 7—DIAPHRAGM SHEAR STRENGTH CONTROLLED BY STABILITY (S_{nb}) WHICH IS THE LESSER OF S_{nl} AND S_{no} ^{1,2,4}

STEEL DECK TYPE	DECK GAGE	Minimum Moment of Inertia ³ , I_{xg} in ⁴ /ft	S_{no} BASED ON L_v (SPAN OF PANEL BETWEEN SUPPORTS WITH FASTENERS, FT - IN.) ^{4,6}												
			Any Span	4'-0"	5'-0"	6'-0"	7'-0"	8'-0"	9'-0"	10'-0"	11'-0"	12'-0"	13'-0"	14'-0"	15'-0"
ASD			S_{nl}/Ω_{nl} (plf) ⁵	S_{no}/Ω_{no} where $\Omega_{no} = 2.00$											
Standard 1 1/2-inch Deep Flutes, 6 Inches Center-to-Center	22	0.173	1,661	4,360	2,790	1,938	1,424	1,090	861	698	576	484	413	356	310
	20	0.210	2,350	5,829	3,731	2,591	1,903	1,457	1,151	933	771	648	552	476	415
	18	0.279	3,880	8,904	5,698	3,957	2,907	2,226	1,759	1,425	1,177	989	843	727	633
	16	0.353	5,872	12,644	8,092	5,620	4,129	3,161	2,498	2,023	1,672	1,405	1,197	1,032	899
Standard 3-Inch Deep Flutes, 8 Inches Center-to-Center	22	0.808	624	13,281	8,500	5,903	4,337	3,320	2,623	2,125	1,756	1,476	1,257	1,084	944
	20	0.989	892	17,870	11,437	7,942	5,835	4,467	3,530	2,859	2,363	1,986	1,692	1,459	1,271
	18	1.323	1,492	27,435	17,559	12,193	8,958	6,859	5,419	4,390	3,628	3,048	2,597	2,240	1,951
	16	1.672	2,278	38,928	24,914	17,301	12,711	9,732	7,689	6,228	5,147	4,325	3,685	3,178	2,768
LRFD			$\phi_{nl} \cdot S_{nl}$ (plf) ⁵	$\phi_{no} S_{no}$ where $\phi_{no} = 0.80$											
Standard 1 1/2-inch Deep Flutes, 6 Inches Center-to-Center	22	0.173	2,658	6,975	4,464	3,100	2,278	1,744	1,378	1,116	922	775	843	7,27	633
	20	0.210	3,760	9,327	5,969	4,145	3,046	2,332	1,842	1,492	1,233	1,036	1,197	1,032	899
	18	0.279	6,208	14,246	9,118	6,332	4,652	3,562	2,814	2,279	1,884	1,583	1,257	1,084	944
	16	0.353	9,395	20,231	12,948	8,992	6,606	5,058	3,996	3,237	2,675	2,248	1,692	1,459	1,271
Standard 3-inch Deep Flutes, 8 Inches Center-to-Center	22	0.808	998	21,250	13,600	9,444	6,939	5,312	4,197	3,400	2,810	2,361	2,597	2,240	1,951
	20	0.989	1,427	28,591	18,298	12,707	9,336	7,148	5,648	4,575	3,781	3,177	3,685	3,178	2,768
	18	1.323	2,387	43,896	28,094	19,509	14,334	10,974	8,671	7,023	5,804	4,877	843	727	633
	16	1.672	3,645	62,284	39,862	27,682	20,338	15,571	12,303	9,965	8,236	6,920	1,197	1,032	899

For **SI**: 1 inch = 25.4 mm, 1 ksi = 6.89 MPa, 1 plf = 0.0146 N/mm, 1 in⁴/ft = 1,368 mm⁴/mm.

¹Diaphragm resistance must be limited to lesser S_{nb} and the corresponding respective ASD and LRFD shear capacities shown in [Tables 3](#) through [6](#) or calculated per Section 4.1 of this report.

²Tabulated values are based on AISI S310-20 w/ S1-22 Section D2.

³The tabulated moment of inertia, I_{xg} , is the moment of inertia of the fully effective panel.

⁴ S_{nb} must be based on the lesser of S_{nl} and S_{no} .

⁵ S_{nl} is the diaphragm shear strength controlled by located web buckling of panel over exterior support. S_{nl} is based on a bearing length at exterior support of 3 inches.

⁶ S_{no} is the diaphragm shear strength controlled by panel out-of-plane buckling. S_{no} is based the span panel between supports with fasteners (L_v).

TABLE 8—ALLOWABLE DIAPHRAGM SHEARS, q (plf) AND FLEXIBILITY FACTORS, F (micro-inches/lb)^{1,2,3,4,5,6,7}

DECK: 1½-INCH DEEP, 6-INCH ON CENTER FLUTES (see figure in [Table 10](#))

FRAME FASTENERS: HILTI X-HSN 24 or X-ENP-19 L15

SIDELAP CONNECTIONS: BUTTON PUNCH (see Section 4.2)

CONCRETE FILL: LIGHTWEIGHT OR NORMALWEIGHT (see Section 3.3)

d _c f' _c FILL TYPE	GAGE	SIDELAP CONNECTION	FACTOR	1 1/2-INCH DEEP, 6-INCH ON CENTER FLUTES	1 1/2-INCH DEEP, 6-INCH ON CENTER FLUTES
				Lightweight Concrete	Normalweight Concrete
2½" 3,000 psi Concrete	22	Button Punch @ 36" o.c.	S _{nf} /Ω _{nf}	2800	3626
			F	0.41	0.41
	20	Button Punch @ 36" o.c.	S _{nf} /Ω _{nf}	2851	3671
			F	0.41	0.41
	18	Button Punch @ 36" o.c.	S _{nf} /Ω _{nf}	2944	3753
			F	0.41	0.41
	16	Button Punch @ 36" o.c.	S _{nf} /Ω _{nf}	3043	3841
			F	0.41	0.41
3¼" 3,000 psi Lightweight Concrete 3½" 3,000 psi Normal Weight Concrete	22	Button Punch @ 36" o.c.	S _{nf} /Ω _{nf}	3392	4678
			F	0.32	0.29
	20	Button Punch @ 36" o.c.	S _{nf} /Ω _{nf}	3442	4723
			F	0.32	0.29
	18	Button Punch @ 36" o.c.	S _{nf} /Ω _{nf}	3535	4805
			F	0.32	0.29
	16	Button Punch @ 36" o.c.	S _{nf} /Ω _{nf}	3635	4892
			F	0.32	0.29
4½" 3,000 psi Concrete	22	Button Punch @ 36" o.c.	S _{nf} /Ω _{nf}	4378	5730
			F	0.23	0.23
	20	Button Punch @ 36" o.c.	S _{nf} /Ω _{nf}	4428	5774
			F	0.23	0.23
	18	Button Punch @ 36" o.c.	S _{nf} /Ω _{nf}	4521	5856
			F	0.23	0.23
	16	Button Punch @ 36" o.c.	S _{nf} /Ω _{nf}	4621	5944
			F	0.23	0.23
5½" 3,000 psi Concrete	22	Button Punch @ 36" o.c.	S _{nf} /Ω _{nf}	-	6781
			F	-	0.19
	20	Button Punch @ 36" o.c.	S _{nf} /Ω _{nf}	-	6826
			F	-	0.19
	18	Button Punch @ 36" o.c.	S _{nf} /Ω _{nf}	-	6908
			F	-	0.19
	16	Button Punch @ 36" o.c.	S _{nf} /Ω _{nf}	-	6995
			F	-	0.19

For SI: 1 inch = 25.4 mm, 1 ksi = 6.89 MPa, 1 plf = 0.0146 N/mm, 1 in4/ft = 1,368 mm4/mm.

¹Concrete cover depth as indicated in table above.

²Values based on AISI S310-20 w/ S1-22 Section D4.1.1 for structural concrete-filled diaphragms. The number or spacing of perimeter edge and perimeter end support fasteners for concrete-filled diaphragms must be determined in accordance with AISI S310-20 w/ S1-22 Section D4.1.2.

³Refer to footnotes following [Table 13](#) for additional installation and design requirements.

⁴See [Table 1](#) for required base steel thickness ranges for each fastener.

⁵Steel deck and reinforcement must comply with Section 3.2 and 3.4, respectively.

⁶For LRFD, multiply the tabulated "q" value by 1.60.

⁷Lightweight concrete must comply with ACI 318.

TABLE 9—ALLOWABLE DIAPHRAGM SHEARS, q (plf) AND FLEXIBILITY FACTORS, F (micro-inches/lb)^{1,2,3,4,5,6,7}

DECK: 2 OR 3-INCH-DEEP, 12-INCH ON CENTER FLUTES (see figures in [Table 10](#))

FRAME FASTENERS: HILTI X-HSN 24 or X-ENP-19 L15

(see applicable pattern below)

SIDLAP CONNECTIONS: BUTTON PUNCH (see Section 4.2)

CONCRETE FILL: LIGHTWEIGHT OR NORMALWEIGHT (see Section 3.3)

d _c f' _c FILL TYPE	GAGE	SIDELAP CONNECTION	FACTOR	2-INCH DEEP, 12-INCH ON CENTER FLUTES	2-INCH DEEP, 12-INCH ON CENTER FLUTES	3-INCH DEEP, 12-INCH ON CENTER FLUTES	3-INCH DEEP, 12-INCH ON CENTER FLUTES
				Lightweight Concrete	Normalweight Concrete	Lightweight Concrete	Normalweight Concrete
2" 3,000 psi Concrete	20	Button Punch @ 36" o.c.	S _{ntf} /Ω _{nf}	2697	3447	3054	3939
			F	0.50	0.51	0.50	0.51
	19	Button Punch @ 36" o.c.	S _{ntf} /Ω _{nf}	-	3496	-	3983
			F	-	0.51	-	0.51
	18	Button Punch @ 36" o.c.	S _{ntf} /Ω _{nf}	2805	3541	3149	4023
			F	0.50	0.51	0.50	0.51
	16	Button Punch @ 36" o.c.	S _{ntf} /Ω _{nf}	2919	3642	3251	4113
			F	0.50	0.51	0.50	0.51
3 1/4" 3,000 psi Lightweight Concrete	20	Button Punch @ 36" o.c.	S _{ntf} /Ω _{nf}	3683	4498	4040	4991
			F	0.32	0.34	0.32	0.34
	19	Button Punch @ 36" o.c.	S _{ntf} /Ω _{nf}	-	4547	-	5034
			F	-	0.34	-	0.34
	18	Button Punch @ 36" o.c.	S _{ntf} /Ω _{nf}	3791	4593	4135	5075
			F	0.32	0.34	0.32	0.34
	16	Button Punch @ 36" o.c.	S _{ntf} /Ω _{nf}	3905	4694	4237	5165
			F	0.32	0.34	0.32	0.34
3" 3,000 psi Normal Weight Concrete	20	Button Punch @ 36" o.c.	S _{ntf} /Ω _{nf}	4275	5550	4632	6043
			F	0.26	0.26	0.26	0.26
	19	Button Punch @ 36" o.c.	S _{ntf} /Ω _{nf}	-	5599	-	6086
			F	-	0.26	-	0.26
	18	Button Punch @ 36" o.c.	S _{ntf} /Ω _{nf}	4382	5644	4727	6127
			F	0.26	0.26	0.26	0.26
	16	Button Punch @ 36" o.c.	S _{ntf} /Ω _{nf}	4497	5746	4829	6216
			F	0.26	0.26	0.26	0.26
4" 3,000 psi Concrete	20	Button Punch @ 36" o.c.	S _{ntf} /Ω _{nf}	5064	6602	5420	7094
			F	0.21	0.21	0.21	0.21
	19	Button Punch @ 36" o.c.	S _{ntf} /Ω _{nf}	-	6650	-	7138
			F	-	0.21	-	0.21
	18	Button Punch @ 36" o.c.	S _{ntf} /Ω _{nf}	5171	6696	5516	7178
			F	0.21	0.21	0.21	0.21
	16	Button Punch @ 36" o.c.	S _{ntf} /Ω _{nf}	5286	6797	5617	7268
			F	0.21	0.21	0.21	0.21
5" 3,000 psi Concrete	20	Button Punch @ 36" o.c.	S _{ntf} /Ω _{nf}	5064	6602	5420	7094
			F	0.21	0.21	0.21	0.21
	19	Button Punch @ 36" o.c.	S _{ntf} /Ω _{nf}	-	6650	-	7138
			F	-	0.21	-	0.21
	18	Button Punch @ 36" o.c.	S _{ntf} /Ω _{nf}	5171	6696	5516	7178
			F	0.21	0.21	0.21	0.21
	16	Button Punch @ 36" o.c.	S _{ntf} /Ω _{nf}	5286	6797	5617	7268
			F	0.21	0.21	0.21	0.21

For SI: 1 inch = 25.4 mm, 1 ksi = 6.89 MPa, 1 plf = 0.0146 N/mm, 1 in⁴/ft = 1,368 mm⁴/mm.

¹Concrete cover depth as indicated in table above.

² Values based on AISI S310-20 w/ S1-22 Section D4.1.1 for structural concrete-filled diaphragms. The number or spacing of perimeter edge and perimeter end support fasteners for concrete-filled diaphragms must be determined in accordance with AISI S310 Section D4.1.2.

³Refer to footnotes following [Table 13](#) for additional installation and design requirements.

⁴See [Table 1](#) for required base steel thickness ranges for each fastener.

⁵Steel deck and reinforcement must comply with Section 3.2 and 3.4, respectively.

⁶ For LRFD, multiply the tabulated "q" value by 1.60.

⁷Lightweight concrete must comply with ACI 318.

TABLE 10—DECK TYPES FOR CONCRETE FILLED DIAPHRAGMS

DECK	DECK TYPES	FIGURE
1½" deep B deck – 36" wide	Type A	Figure 1
2" deep – 36" wide	Type B	Figure 2
3" deep – 36" wide	Type C	Figure 3

For SI: 1 inch = 25.4 mm, 1 psi = 6.89 kPa.

Notes:

- 1.) Steel deck panels must comply with Section 3.2.

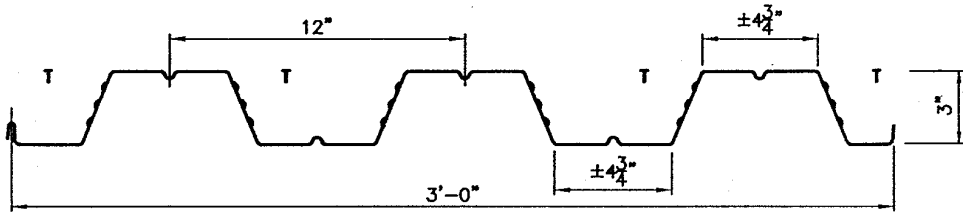

For SI: 1 inch = 25.4 mm.

FIGURE 1—1½" B DECK – 36" WIDE (TYPE A)

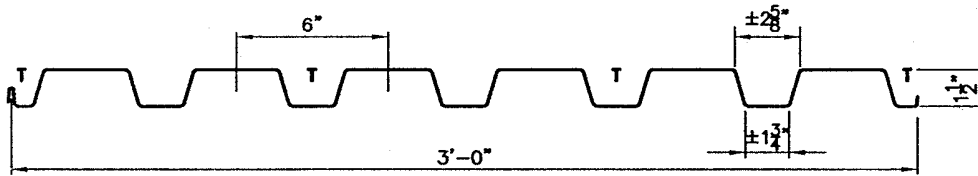

For SI: 1 inch = 25.4 mm.

FIGURE 2—2" DECK – 36" WIDE (TYPE B)

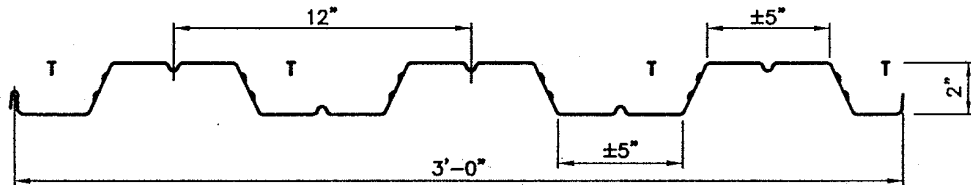

For SI: 1 inch = 25.4 mm.

FIGURE 3—3" DECK – 36" WIDE (TYPE C)

TABLE 11—NOMINAL SHEAR, P_{nf} (LBS), AND FLEXIBILITY FACTORS, S_f (IN./KIP), FOR X-HSN 24 OR X-ENP-19 L15 FASTENERS ATTACHING STEEL DECK TO STEEL SUPPORTS¹

FASTENER	FACTOR	PANEL THICKNESS (IN.)			
		0.0598 (16 GAGE)	0.0474 (18 GAGE)	0.0358 (20 GAGE)	0.0295 (22 GAGE)
X-HSN 24	P_{nf}	2924	2348	1795	1489
	S_f	0.0051	0.0057	0.0066	0.0073
X-ENP-19 L15	P_{nf}	3149	2529	1933	1603
	S_f	0.0031	0.0034	0.0040	0.0044

For SI: 1 inch = 25.4 mm, 1 lbf = 4.45 N, 1 inch/kip = 5.7 mm/kN.

¹Refer to footnotes following [Table 13](#) for additional installation and design requirements.

TABLE 12—ALLOWABLE (ASD) TENSION PULLOUT LOADS TO RESIST TENSION (UPLIFT) LOADS FOR STEEL DECK PANELS ATTACHED WITH X-HSN 24 OR X-ENP-19 L15 FASTENERS (LBS)^{1,2}

FASTENER	BASE MATERIAL THICKNESS, in.						
	1/8	3/16	1/4	5/16	3/8	1/2 ³	≥ 5/8 ⁴
ASTM A36 ($F_y = 36$ ksi, $F_u = 58$ ksi)							
X-HSN 24	435	635	750	750	750	-	-
X-ENP-19 L15	-	-	905	1,010	1,125	1,010	965
ASTM A572 or A992 Grade 50 ($F_y = 50$ ksi, $F_u = 65$ ksi)							
X-HSN 24	445	635	750	750	750	-	-
X-ENP-19 L15	-	-	975	1,090	1,205	1,090	1,040

For SI: 1 inch = 25.4 mm, 1 lbf = 4.45 N, 1 ksi = 6.89 MPa.

¹Tabulated allowable (ASD) values based upon a safety factor (Ω) of 5.0. To obtain LRFD pullout capacities, the tabulated values must be multiplied by 1.6.

²Unless otherwise noted, the tabulated pullout values are based on minimum penetration of fasteners of 9/16-inch for the X-ENP-19 fasteners. The X-HSN 24 fastener tabulated values are based upon fastener stand-off dimensions shown in [Figure 6](#).

³Tabulated pullout capacities in 1/2-inch steel based upon a minimum point penetration of 1/2-inch. If 1/2-inch point penetration is not achieved, but a point penetration of at least 3/8-inch is obtained, the tabulated value must be multiplied by a factor of 0.63.

⁴Tabulated pullout capacities in greater than or equal to 5/8-inch steel based upon a minimum point penetration of 1/2-inch. If 1/2-inch point penetration is not achieved, but a point penetration of at least 3/8-inch is obtained, the tabulated value must be multiplied by a factor of 0.82.

TABLE 13—ALLOWABLE TENSION PULLOVER LOADS TO RESIST TENSION (UPLIFT) LOADS FOR STEEL DECK PANELS ATTACHED WITH X-HSN 24 OR X-ENP-19 L15 FASTENERS (LBS)^{1,2}

FASTENER	BASE STEEL THICKNESS, in.	DECK GAGE (in.)			
		No. 22 (0.0295)	No. 20 (0.0358)	No. 18 (0.0474)	No. 16 (0.0598)
X-HSN 24	1/8 ≤ t_f ≤ 3/8	500	560	725	865
X-ENP-19 L15	≥ 1/4	660	705	805	880

For SI: 1 inch = 25.4 mm, 1 lbf = 4.45 N.

¹Tabulated allowable (ASD) values are based upon a safety factor (Ω) of 3.0. To obtain LRFD pullout capacities, the tabulated values must be multiplied by 1.6.

²Based upon minimum ASTM A653 SS Grade 33 ($F_y = 33$ ksi, $F_u = 45$ ksi) steel deck as described in Section 3.2 of this report.

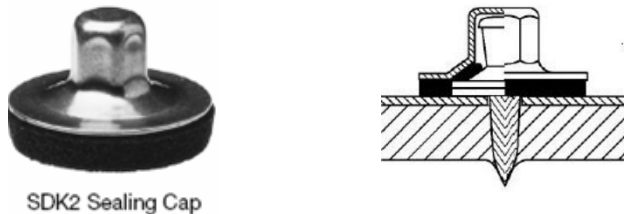

SDK2 Sealing Cap

Note: To be used with X-ENP-19 L15 fasteners. X-ENP-19 Nailhead standoff (h_{NVS}) must be as shown in [Figure 5](#)

FIGURE 4—SDK2 SEALING CAP

FOOTNOTES TO TABLES 3 THROUGH 13

1. Hilti, X-HSN 24 or X-ENP-19 L15 fasteners are used at all panel ends, interior supports and deck edges parallel to the deck corrugations. The sides of adjacent panels parallel to the corrugations are lapped by nesting or interlocking and then fastened with a minimum No. 10 self-drilling steel screws as described in Section 3.6 or button punched.
2. Evenly spaced seam connectors per span length excluding those at supports.
3. The following assumptions apply to the attached tables:
 - a. The deck sheet length is assumed to equal the span times the number of spans.
 - b. All tables are based on a three span condition.
 - c. For steel deck diaphragms in Tables 3 – 6, the number of diaphragm edge fasteners at walls or transfer zones parallel to the deck corrugations is assumed to equal the same number of stitch or sidelap connectors at interior sidelaps.
 - d. For concrete filled diaphragms in Tables 8 and 9, the number of edge fasteners at walls or transfer zones parallel to the deck corrugations shall not exceed 30 inches (762 mm) on center.
4. Tables 3 – 5, 8, and 9 apply to intermediate and wide rib 1 1/2-inch (38 mm) deep steel deck with a flute pitch of 6 inches provided adequate space is available for fastener placement.
5. Tables 6 apply to 3-inch deep steel deck with flute pitch of 8 inches provided adequate space is available for fastener placement.
6. For Tables 8 and 9, No.10 screws or larger may be substituted for the specified button punches.
7. The embedment of Hilti fasteners into the structural support member is such that the standoff dimension, h_{NVS} in Figures 5 and 6 is obtained.
8. Hilti fasteners shall be centered not less than 1 inch (25 mm) from the panel ends and not less than 5/16 inch (7.9 mm) from the panel edges parallel to corrugations at the sidelaps.
9. Diaphragm deflections must be considered in the design. Table 14 describes diaphragm limitations.
 - a. Flexibility Factor F is defined as the average micro-inches a diaphragm web will deflect in a span of one foot under a shear load of one pound per foot.
 $F = 1000/G'$, micro-inches/pound ($\mu\text{m}/\text{N}$)

b. The general deflection equation is:

$$\frac{d^2y}{dx^2} = M / EI + q / B G'$$

For a uniformly loaded rectangular diaphragm on a simple span, the maximum deflection at the centerline of the diaphragm is:

$$\Delta = 5(1728)qL^4 / 384 EI + qLF / 10^6$$

(For SI: $5(1000)^4 qL^4 / 384 EI + qLF/10^6$)

Δ = Diaphragm deflection, inches (mm).

q = Wind or seismic load, kips per lineal foot (N/m)

q_{ave} = Average shear in diaphragm in pounds per foot (N/m) over length L.

L = Length of diaphragm normal to load, feet (m).

B = Width of diaphragm parallel to load, feet (m).

E = Modulus of elasticity of supporting steel chord material, pounds per square inch (kPa).

I = Moment of inertia, inches⁴ (mm⁴).

Diaphragm deflection equations provided apply to rectangular symmetrical diaphragms only. Nonrectangular diaphragms, nonsymmetrical diaphragms with re-entrant corners or diaphragms subjected to torsional loadings require special design considerations.

- c. Roof diaphragms supporting masonry or concrete walls shall have their deflections limited to the following:

$$\Delta = H^2 f_c / 0.01E t$$

(For SI: $694,000 H^2 f_c / EI$)

Δ = Deflection of top of wall, inches (mm).

H = Wall height, feet (mm).

T = Thickness of the wall, inches (mm).

E = Modulus of elasticity of the wall material, pounds per square inch (kPa).

f_c = Allowable flexural compressive strength of the wall material, pounds per square inch (kg/m^3).
 For masonry $f_c = 0.33f'_m$; for concrete $f_c = 0.45f'_c$.

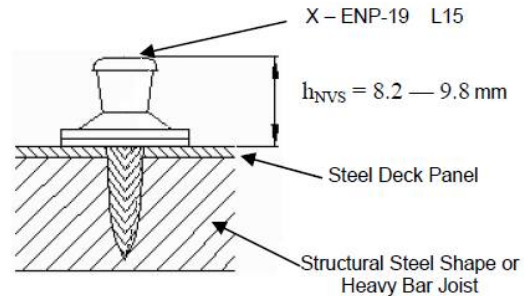

FIGURE 5—NAIL HEAD STANDOFF (h_{NVS}) FOR X-ENP-19 L15 FASTENERS

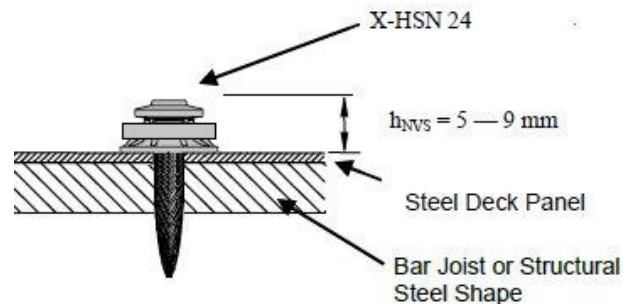

FIGURE 6—NAIL HEAD STANDOFF (h_{NVS}) FOR X-HSN 24 FASTENERS

TABLE 14—DIAPHRAGM FLEXIBILITY LIMITATION^{1,2,3,4,5}

(Only applicable to 2015 IBC and earlier editions)

F	MAXIMUM SPAN IN FEET FOR MASONRY OR CONCRETE WALLS	SPAN-DEPTH LIMITATION			
		Rotation Not Considered in Diaphragm		Rotation Considered in Diaphragm	
		Masonry or Concrete Walls	Flexible Walls	Masonry or Concrete Walls	Flexible Walls
More than 150	Not used	Not used	2:1	Not used	1 ¹ / ₂ :1
70 – 150	200	2:1 or as required for deflection	3:1	Not used	2:1
10 – 70	400	2 ¹ / ₂ :1 or as required for deflection	4:1	As required for deflection	2 ¹ / ₂ :1
1 – 10	No limitation	3:1 or as required for deflection	5:1	As required for deflection	3:1
Less than 1	No limitation	As required for deflection	No limitation	As required for deflection	3 ¹ / ₂ :1

For SI: 1 inch = 25.4 mm, 1 foot = 304.8 mm, 1 plf = 14.594 N/m, 1 psi = 6894 Pa.

¹Diaphragms are to be investigated regarding their flexibility and recommended span-depth limitations.

²Diaphragms supporting masonry or concrete walls are to have their deflections limited to the following amount:

$$\Delta_{wall} = \frac{H^2 f_c}{0.01 Et} \quad \text{For SI: } \Delta_{wall} = \frac{694,000 H^2 f_c}{Et}$$

where:

- H = Unsupported height of wall in feet or millimeters.
- t = Thickness of wall in inches or millimeters.
- E = Modulus of elasticity of wall material for deflection determination in pounds per square inch or kilopascals.
- f_c = Allowable compression strength of wall material in flexure in pounds per square inch or kilopascals. For concrete, f_c = 0.45 f_c. For masonry, f_c = F_b = 0.33 f_m.

³The total deflection Δ of the diaphragm may be computed from the equation: Δ = Δ_f + Δ_w.

where:

- Δ_f = Flexural deflection of the diaphragm determined in the same manner as the deflection of beams.
- Δ_w = The web deflection may be determined by the equation:

$$\Delta_w = \frac{q_{ave} L F}{10^6} \quad \text{For SI: } \Delta_w = \frac{q_{ave} L F}{175}$$

where:

- L = Distance in feet between vertical resisting element (such as shear wall) and the point to which the deflection is to be determined.
- q_{ave} = Average shear in diaphragm in pounds per foot or newtons per meter over length L.
- F = Flexibility factor: The average microinches or micrometers (μm) a diaphragm web will deflect in a span of 1 foot (m) under a shear of 1 pound per foot (N/m).

⁴When applying these limitations to cantilevered diaphragms, the allowable span-depth ratio will be half that shown.

DIVISION: 05 00 00—METALS
Section: 05 05 23—Metal Fastenings
Section: 05 31 00—Steel Decking

REPORT HOLDER:

HILTI, INC.

EVALUATION SUBJECT:

BARE STEEL DECK AND CONCRETE-FILLED STEEL DECK DIAPHRAGMS ATTACHED WITH HILTI X-HSN 24 OR X-ENP-19 L15 POWDER-DRIVEN FRAME FASTENERS

1.0 REPORT PURPOSE AND SCOPE**Purpose:**

The purpose of this evaluation report supplement is to indicate that the bare steel deck and concrete-filled steel deck diaphragms attached with Hilti X-HSN 24 or X- ENP-19 L 15 powder-driven frame fasteners, described in ICC-ES evaluation report [ESR-2197](#), have also been evaluated for compliance with the codes noted below as adopted by the Los Angeles Department of Building and Safety (LADBS).

Applicable code editions:

- 2023 *City of Los Angeles Building Code* (LABC)

2.0 CONCLUSIONS

The bare steel deck and concrete-filled steel deck diaphragms attached with Hilti X-HSN 24 or X- ENP-19 L 15 powder-driven frame fasteners, described in Sections 2.0 through 7.0 of the evaluation report [ESR-2197](#), comply with the LABC Chapter 22, and are subjected to the conditions of use described in this supplement.

3.0 CONDITIONS OF USE

The bare steel deck and concrete-filled steel deck diaphragms attached with Hilti X-HSN 24 or X- ENP-19 L 15 powder-driven frame fasteners described in this evaluation report supplement must comply with all of the following conditions:

- All applicable sections in the evaluation report [ESR-2197](#).
- The design, installation, conditions of use and identification are in accordance with the 2021 *International Building Code*® (2021 IBC) provisions noted in the evaluation report [ESR-2197](#).
- The design, installation and inspection are in accordance with additional requirements of LABC Chapters 16 and 17, as applicable.
- Diaphragm shear strength values in the evaluation report must not be increased for load combinations that include wind or seismic loads.
- For diaphragms that are used to provide wall anchorage, the adequacy of the steel deck panel end and side seam connections must be verified by a registered design professional to the satisfaction of the code official.

This supplement expires concurrently with the evaluation report, reissued December 2023.

DIVISION: 05 00 00—METALS
Section: 05 05 23—Metal Fastenings
Section: 05 31 00—Steel Decking

REPORT HOLDER:

HILTI, INC.

EVALUATION SUBJECT:

BARE STEEL DECK AND CONCRETE-FILLED STEEL DECK DIAPHRAGMS ATTACHED WITH HILTI X-HSN 24 OR X-ENP-19 L15 POWDER-DRIVEN FRAME FASTENERS

1.0 REPORT PURPOSE AND SCOPE**Purpose:**

The purpose of this evaluation report supplement is to indicate that Bare Steel Deck and Concrete-Filled Steel Deck Diaphragms Attached with HILTI X-HSN 24 or X-ENP-19 L15 Power-Driven Frame Fasteners, described in ICC-ES evaluation report ESR-2197, has also been evaluated for compliance with the code noted below.

Applicable code editions:

- 2023 *Florida Building Code—Building*

2.0 CONCLUSIONS

The Bare Steel Deck and Concrete-Filled Steel Deck Diaphragms Attached with HILTI X-HSN 24 or X-ENP-19 L15 Power-Driven Frame Fasteners, described in Sections 2.0 through 7.0 of ICC-ES evaluation report ESR-2197, comply with the *Florida Building Code—Building*. The design requirements must be determined in accordance with the *Florida Building Code—Building*. The installation requirements noted in ICC-ES evaluation report ESR-2197 for the 2021 *International Building Code*® meet the requirements of the *Florida Building Code—Building*, with the following conditions:

Use of the Bare Steel Deck and Concrete-Filled Steel Deck Diaphragms Attached with HILTI X-HSN 24 or X-ENP-19 L15 Power-Driven Frame Fasteners has also been found to be in compliance with the High-Velocity Hurricane Zone provisions of the *Florida Building Code—Building* and must comply with the following conditions of use:

When the power-driven frame fasteners are used with 22 gage or less (thinner) steel decking, the steel decking must have minimum G90 galvanizing in accordance with Section 2222.6.1 of the FBC.

For products falling under Florida Rule 61G20-3, verification that the report holder's quality assurance program is audited by a quality assurance entity approved by the Florida Building Commission for the type of inspections being conducted is the responsibility of an approved validation entity (or the code official when the report holder does not possess an approval by the Commission).

This supplement expires concurrently with the evaluation report, reissued December 2023.