



**2024-25
PRODUCT
CATALOG**

SELECTOR GUIDE

PG# APPLICATION AND PRODUCT

6 LIGHT DUTY STEEL-TO-STEEL APPLICATIONS

- #8, #10, and 1/4" diameter Tekes 1, 2, and 3 drill points
- Hex Head

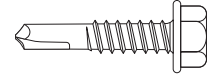

8 MEDIUM DUTY STEEL-TO-STEEL APPLICATIONS

- #12 and 1/4" diameter Tekes 2 and 3 drill points
- Hex head

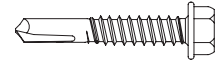

10 HEAVY DUTY STEEL-TO-STEEL APPLICATIONS

- #12, and 1/4" diameter Tekes 4, 4.5, and 5 drill points
- Hex head

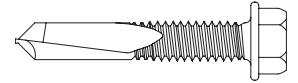

12 HEAVY DUTY STEEL-TO-STEEL APPLICATIONS

- #12 diameter Tekes 5.0 point
- Hex head

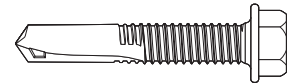

14 ATTACHING SIMILAR OR DISSIMILAR METAL APPLICATIONS

- #10, #12 and 1/4" diameter Tekes 3 and 4 points
- Hex head



16 LOW PROFILE ARCHITECTURAL APPLICATIONS

- #10 and #12 diameter Tekes 3 and Type AB points
- Pancake Phillips and Phillips Square-Driv® heads

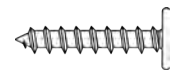

18 WOOD-TO-METAL APPLICATIONS

- #10, #12, and 1/4" diameter Tekes 3 and 4 drill points
- Wafer, Phillips flat, and Phillips Square-Driv® heads



20 METAL ROOF AND WALL APPLICATIONS

- #10, #12, and 1/4" diameter Tekes 1, 2, 3, 4, 4.5 and 5 drill points
- Hex with bonded washer

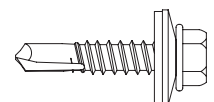

PG# APPLICATION AND PRODUCT

22 PREMIUM METAL ROOF AND WALL APPLICATIONS

- #10, #12, and 1/4" diameter Tekes 1, 2, and 3 drill points
- #17 diameter Type AB sharp point
- Maxiseal® integral washer system

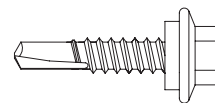

24 LONG LIFE METAL ROOF AND WALL APPLICATIONS

- #12 and 1/4 diameter Tekes 1, 2, 3, and 5 drill points
- #17 diameter Type AB sharp point
- Scots® 300SS encapsulated head with Maxiseal integral washer system

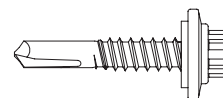

26 METAL-TO-WOOD APPLICATIONS

- #9 diameter, sharp point; #14 diameter Hi-Lo Type 17 point Trugrip™
- Hex with or without bonded washer

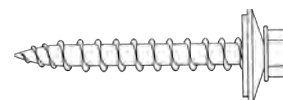

28 PIPE FLASHING APPLICATIONS

- Dektite®
- EPDM and silicone for 1/4" to 13" pipes

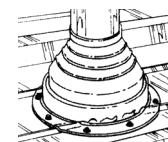

29 METAL ROOF END CAP FLASHING APPLICATIONS

- Dek-Cap™ standing seam roof end cap flashing

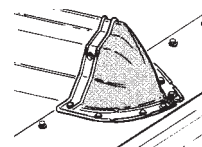

30 DRYWALL ANCHOR APPLICATIONS

- E-Z Ancor®, Stud Solver™, Plastic Plus™, E-Z Toggle™, E-Z Lite™, Twist-N-Lock™

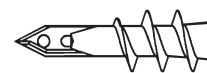

32 CEMENT BOARD APPLICATIONS

- Hi-Lo® and S-12® Rock-On™ screws
- Countersinking wafer head

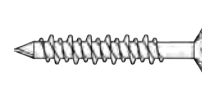

34 EXTERIOR WOOD APPLICATIONS

- #6, #7, #8, and #10 diameter Dec-King™ screws

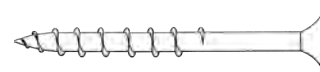

FEATURES

HEAD

Proper head style choice will ensure stability during driving, proper clamping, and desired finished appearance.

THREAD FORM AND DIAMETER

The correct choice of thread form and diameter optimizes low installation torque with high pullout strength

PILOT SECTION

The unthreaded portion of the point assures that the drilling of the steel is completed before the threads begin tapping into the drilled hole.

POINT

The point is designed to efficiently remove material and precisely size the hole for the thread.

FINISH

Platings and coatings provide lubricity during drilling and tapping as well as corrosion resistance.

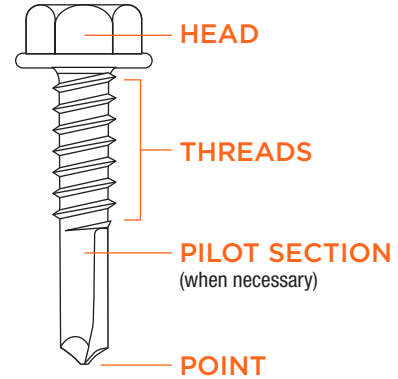

FASTENER DESCRIPTION AND BREAKDOWN EXAMPLE

| | | | | | | |
|--------------------|---|------------------|---|--------------|------------|------------------|
| 10 | - | 16 | x | 3/4" | HWH | TEKS/3 |
| Nominal Screw Size | | Threads Per Inch | | Screw Length | Head Style | Drill Point Type |

| NOMINAL SCREW SIZES | |
|---------------------|----------------------|
| THREAD DIAM. | DECIMAL EQUIV. (IN.) |
| #6 | .140 |
| #7 | .150 |
| #8 | .160 |
| #9 | .180 |
| #10 | .190 |
| #11 | .200 |
| #12 | .210 |
| #13 | .230 |
| #14 | .240 |
| 1/4" | .250 |
| #17 | .286 |

| STEEL GAUGE CHART | | |
|---------------------------|----------------|-------|
| COMMON SHEET STEEL GAUGES | DECIMAL EQUIV. | |
| | IN. | MM |
| 30 | .012 | 0.30 |
| 28 | .015 | 0.38 |
| 26 | .018 | 0.45 |
| 24 | .024 | 0.61 |
| 22 | .030 | 0.76 |
| 20 | .036 | 0.91 |
| 18 | .048 | 1.21 |
| 16 | .060 | 1.52 |
| 14 | .075 | 1.90 |
| 12 | .105 | 2.65 |
| 1/8" | .125 | 3.18 |
| 10 | .134 | 3.42 |
| 3/16" | .187 | 4.77 |
| 1/4" | .250 | 6.36 |
| 1/2 | .500 | 12.72 |

| MAXIMUM RECOMMENDED INSTALLATION RPM | |
|--------------------------------------|------|
| DIAMETER | RPM |
| #6 | 2500 |
| #8 | |
| #10 | |
| #12 | |
| #12* | 1800 |
| 1/4" | |
| 5/16" | 1200 |

*Applies to #12 diameter screws with point types 4, 4.5 and 5

Warranty Information

Proper fastener connection design takes into account where and how fasteners are used. Allowance for special characteristics in materials, differences in types of materials being joined, unique or unusual environmental service or installation conditions, and the safety factors required by anticipating normal or short term loading conditions must be considered. Due to possible differences in specifications, applications and interpretation of results, purchasers and specifiers must make their own evaluation of the products, to determine the suitability of these products for intended use. All warranties of Buildex products, expressed or implied, including the warranties of merchantability and fitness for particular purposes are specifically excluded except for the following: Buildex will repair or replace any product which, within twelve months after sale by Buildex or its distributors, is found by Buildex to be defective in material or workmanship -- normal wear and tear expected. This is the sole warranty of Buildex and the sole remedy available to distributor or buyer. Buildex shall not be liable for any injury, loss or damage, direct, indirect, incidental or consequential, arising out of the use of, or the inability to use, any Buildex product.

CORROSION RESISTANCE OF DIFFERENT COATINGS

Descriptions of coatings available with technical data on composition and application. Visit www.itwbuildex.com to download coating reports. For further assistance, please contact technical support at 630-848-5611.

| COATING | COLOR | ASTM B117 SS (HOURS) |
|------------------------------------|--------|----------------------|
| Gray Spex | Gray | 300 |
| Climacoat | Gray | 500 |
| Gray Climaseal | Gray | 720 |
| Climaseal CR | Silver | 1,000 |
| Silver Climaseal ACR | Silver | 1,000 |
| Electro-Zinc | Silver | 48 |
| Silver Climaseal over Electro-Zinc | Silver | 720 |

POINT SIZE SELECTION - MAXIMUM COMBINED MATERIAL THICKNESS BY POINT TYPE

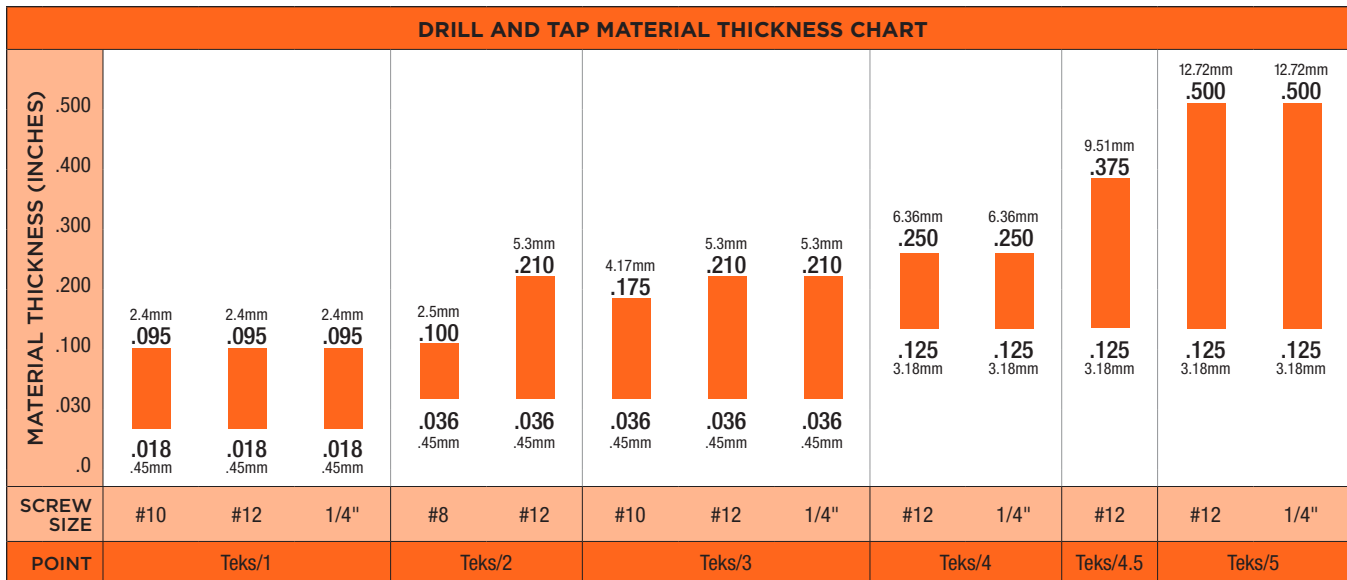
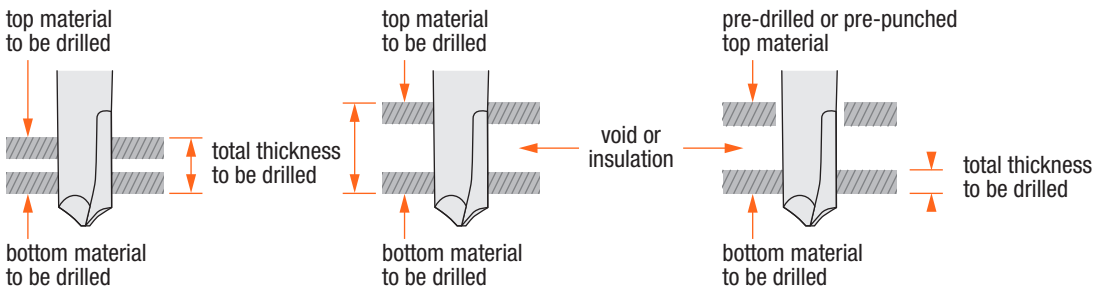

*Drill & tap capacities may vary with special feature designs. Refer to product reports for specifics.

TEKS®

LIGHT DUTY SELF-DRILLING FASTENERS

Preferred most by electrical, decking, HVAC and metal building contractors

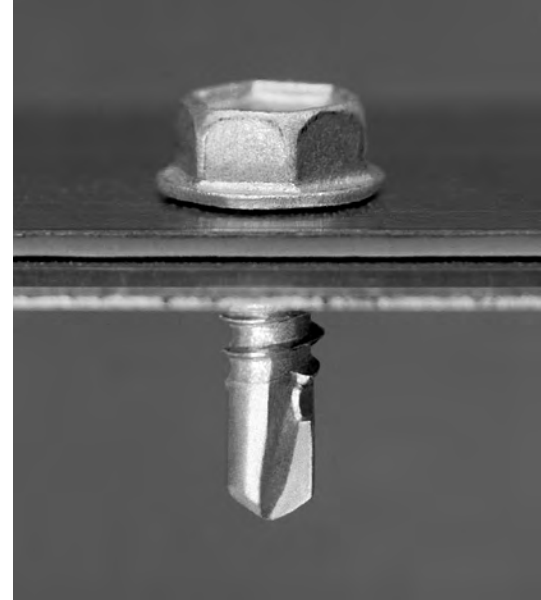

PRODUCT FEATURES

- Sharp convex drill point has precise cutting edges to improve drill performance with less effort
- Non-walking point provides fast material engagement
- Unique point to thread design extrudes the metal preventing stripout
- Point to thread design maximizes pullout performance and minimizes backout
- Four head styles available to handle various applications
- Climaseal® finish provides excellent corrosion resistance and lower tapping torque

SELECTOR GUIDE

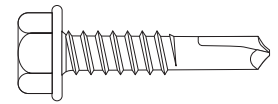

| PART NO. | DESCRIPTION | HEAD STYLE | DRILL POINT | FINISH | DRILL & TAP CAPACITY (IN.) | MAX. MATERIAL ATTACHMENT (IN.) | BOX QTY | APPLICATIONS |
|----------|----------------|------------|-------------|--------------|----------------------------|--------------------------------|---------|--|
| 1196200 | 8-18 x 1/2" | 1/4" HWH | #2 | Electro-zinc | .036 -.100 | .205 | 10,000 | HVAC, electrical trim accessories to steel framing |
| 1107053 | 10-16 x 3/4" | 5/16" HWH | #1 | Climaseal | .018 -.095 | .220 | 5,000 | Stitching roof deck, wall panel sidelaps or duct work |
| †1399000 | 1/4-14 x 7/8" | 5/16" HWH | #1 | Climaseal | .018 -.095 | .380 | 5,000 | |
| †1891000 | 1/4-14 x 7/8" | 3/8" HWH | #1 | Climaseal | .018 -.095 | .380 | 4,000 | |
| 1397000 | 10-16 x 1/2" | 5/16" HWH | #3 | Climaseal | .036 -.175 | .150 | 5,000 | Clips, duct straps, brick ties or accessories to steel framing |
| 1127000 | 10-16 x 5/8" | 5/16" HWH | #3 | Climaseal | .036 -.175 | .200 | 5,000 | |
| 1128000 | 10-16 x 3/4" | 5/16" HWH | #3 | Climaseal | .036 -.175 | .325 | 5,000 | |
| 1129000 | 10-16 x 1" | 5/16" HWH | #3 | Climaseal | .036 -.175 | .575 | 5,000 | |
| 1130000 | 10-16 x 1-1/4" | 5/16" HWH | #3 | Climaseal | .036 -.175 | .825 | 4,000 | |
| 1131000 | 10-16 X 1-1/2" | 5/16" HWH | #3 | Climaseal | .036 -.175 | 1.075 | 3,000 | |
| 1786200 | 10-24 x 3/4" | *5/16" HWH | #2 | Electro-zinc | .036 -.175 | .200 | 5,000 | Vibration resistance; HVAC applications |
| 1821200 | 10-16 x 3/4" | *5/16" HWH | #3 | Electro-zinc | .036 -.175 | .323 | 5,000 | |

†With ABOT™ (Anti-backout threadform) *With serrations under head



INSTALLATION GUIDELINES

- A standard screwgun with a depth sensitive nosepiece should be used to install TekS. For optimal fastener performance, the screwgun should be a minimum of 4 amps and have a RPM range of 0-2500.
- Adjust the screwgun nosepiece to properly seat the fastener.
- New magnetic sockets must be correctly set before use. Remove chip build-up as needed.
- The fastener is fully seated when the head is flush with the work surface.
- Overdriving may result in torsional failure of the fastener or stripout of the substrate.
- The fastener must penetrate beyond the metal structure a minimum of 3 pitches of thread.

HEAD STYLES



APPROVALS AND LISTINGS

Factory Mutual (3050495), ICC ESR-3270, ICC ESR-1976

www.itwbuildex.com

PERFORMANCE DATA

| PULLOUT VALUES (AVERAGE LBS. ULTIMATE) | | | | | | | | | |
|--|-----|-------------|-----|-----|-----|-----|------|------|------|
| FASTENER | | STEEL GAUGE | | | | | | | |
| DIA. | PT. | 26 | 24 | 22 | 20 | 18 | 16 | 14 | 12 |
| #8 | 2 | 119 | 193 | 265 | 298 | 491 | 703 | 959 | - |
| #10 | 1 | 148 | 241 | 311 | 357 | 565 | 826 | 1111 | 1796 |
| #10 | 3 | 124 | 208 | 266 | 299 | 499 | 708 | 967 | 1474 |
| #12 | 1 | 159 | 261 | 338 | 390 | 649 | 908 | 1259 | 1949 |
| 1/4 | 1 | 208 | 329 | 428 | 562 | 800 | 1151 | - | - |

| FASTENER VALUES | | | |
|-----------------------|------------------------|---------------------------|---------------------------|
| FASTENER (DIA-TPI) | TENSILE (LBS. MIN.) | SHEAR (AVG. LBS. ULT.) | TORQUE (MIN. IN. LBS.) |
| 8-18 | 1545 | 1000 | 42 |
| 10-16 | 1936 | 1400 | 61 |
| 10-24 | 2702 | 1500 | 65 |
| 12-14 | 2778 | 2000 | 92 |
| 1/4-14 | 4060 | 2600 | 150 |

| SHEAR VALUES (AVERAGE LBS. ULTIMATE) | | | | | | | | |
|--------------------------------------|-----|----------------------|-----|-----|------|------|------|-----|
| FASTENER | | STEEL GAUGE (LAPPED) | | | | | | |
| DIA. | PT. | 26 | 24 | 22 | 20 | 18 | 16 | 14 |
| #8 | 2 | 294 | 496 | 560 | 740 | 1060 | - | - |
| #10 | 1 | 398 | 584 | 659 | 884 | 1374 | - | 552 |
| #10 | 3 | - | 455 | 526 | 728 | 1266 | 1540 | - |
| #12 | 1 | 432 | 703 | 753 | 1018 | 1452 | - | - |
| 1/4 | 1 | 511 | 849 | 885 | 1244 | 1764 | - | - |

| SHEET STEEL GAUGES | | | | | | | | |
|--------------------|-------|-------|-------|-------|-------|-------|-------|-------|
| GAUGE NO. | 26 | 24 | 22 | 20 | 18 | 16 | 14 | 12 |
| DECIMAL EQUIVALENT | .018" | .024" | .030" | .036" | .048" | .060" | .075" | .105" |

The values listed are ultimate averages achieved under laboratory conditions and apply to Buildex manufactured fasteners only. Appropriate safety factors should be applied to these values for design purposes.



TEKS®

MEDIUM DUTY SELF-DRILLING FASTENERS

*The best point ever for speed and consistency...
optimum for medium duty steel-to-steel applications.*



PRODUCT FEATURES

- Point has precise cutting edges to improve drill performance with less effort.
- Non-walking point provides fast material engagement.
- Point to thread design maximizes pullout performance and minimizes backout.
- Drills and taps in the broadest range of applications.
- Climaseal® finish provides excellent corrosion resistance and lower tapping torque.

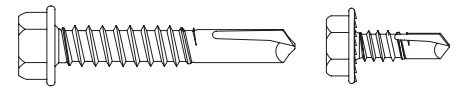

SELECTOR GUIDE

| PART NO. | DESCRIPTION | HEAD STYLE | DRILL POINT | FINISH | DRILL & TAP CAPACITY (IN.) | MAX. MATERIAL ATTACHMENT (IN.) | BOX QTY | APPLICATIONS |
|----------|-----------------|------------|-------------|-----------|----------------------------|--------------------------------|---------|---|
| 1087000 | 12-14 x 3/4" | 5/16" HWH | #3 | Climaseal | .036 - .210 | .270 | 5,000 | Roof deck to steel framing Wall panel to girt Duct work to steel framing Accessories to steel framing Clip to steel framing Retrofit framing |
| 1136000 | 12-14 x 1" | 5/16" HWH | #3 | Climaseal | .036 - .210 | .520 | 4,000 | |
| 1120000 | 12-14 x 1-1/4" | 5/16" HWH | #2 | Climaseal | .036 - .210 | .550 | 4,000 | |
| 1123000 | 12-14 x 1-1/2" | 5/16" HWH | #2 | Climaseal | .036 - .210 | .800 | 2,500 | |
| 1140000 | 12-14 x 2" | 5/16" HWH | #3 | Climaseal | .036 - .210 | 1.450 | 2,000 | |
| 1553000 | 12-14 x 2-1/2" | 5/16" HWH | #3 | Climaseal | .036 - .210 | 1.950 | 1,000 | |
| 1143000 | 12-14 x 3" | 5/16" HWH | #3 | Climaseal | .036 - .210 | 2.450 | 1,000 | |
| 1146000 | 12-14 x 4" | 5/16" HWH | #3 | Climaseal | .036 - .210 | 3.450 | 500 | |
| 1147000 | 1/4-14 x 3/4" | 3/8" HWH | #3 | Climaseal | .036 - .210 | .210 | 3,000 | |
| 1149000 | 1/4-14 x 1" | 3/8" HWH | #3 | Climaseal | .036 - .210 | .400 | 2,500 | |
| 1150000 | 1/4-14 x 1-1/4" | 3/8" HWH | #3 | Climaseal | .036 - .210 | .650 | 2,000 | |
| 1152000 | 1/4-14 x 1-1/2" | 3/8" HWH | #3 | Climaseal | .036 - .210 | .900 | 2,000 | |
| 1155000 | 1/4-14 x 2" | 3/8" HWH | #3 | Climaseal | .036 - .210 | 1.400 | 1,500 | |
| 1554000 | 1/4-14 x 2-1/2" | 3/8" HWH | #3 | Climaseal | .036 - .210 | 1.900 | 1,000 | |
| 1157000 | 1/4-14 x 3" | 3/8" HWH | #3 | Climaseal | .036 - .210 | 2.400 | 1,000 | |
| 1304000 | 1/4-14 x 4" | 3/8" HWH | #3 | Climaseal | .036 - .210 | 3.400 | 500 | |
| 1587000 | 1/4-14 x 1" | *7/16" HWH | #3 | Climaseal | .036 - .210 | .500 | 2,500 | Commercial overhead steel doors, hinges & latches |

*With serrations under head



INSTALLATION GUIDELINES

- A standard screwgun with a depth sensitive nosepiece should be used to install TekS. For optimal fastener performance, the screwgun should be a minimum of 6 amps and have a RPM range of 0-2500.
- Adjust the screwgun nosepiece to properly seat the fastener.
- New magnetic sockets must be correctly set before use. Remove chip build-up as needed.
- The fastener is fully seated when the head is flush with the work surface.
- Overdriving may result in torsional failure of the fastener or stripout of the substrate.
- The fastener must penetrate beyond the metal structure a minimum of 3 pitches of thread.

HEAD STYLES



APPROVALS AND LISTINGS

Factory Mutual (3050495), ICC ESR-3270, ICC ESR-1976

www.itwbuildex.com

PERFORMANCE DATA

| PULLOUT VALUES (AVERAGE LBS. ULTIMATE) | | | | | | | | | | |
|--|-----|-------------|-----|-----|-----|-----|-----|------|------|-------|
| FASTENER | | STEEL GAUGE | | | | | | | | |
| DIA. | PT. | 26 | 24 | 22 | 20 | 18 | 16 | 14 | 12 | 3/16" |
| #12 | 2 | 156 | 243 | 283 | 375 | 605 | 848 | 1181 | 1856 | 3520 |
| #12 | 3 | 142 | 211 | 289 | 341 | 551 | 757 | 1063 | 1631 | 2998 |
| 1/4 | 3 | 141 | 231 | 293 | 346 | 613 | 880 | 1145 | 1858 | 4550 |

| FASTENER VALUES | | | |
|-----------------------|------------------------|---------------------------|---------------------------|
| FASTENER (DIA-TPI) | TENSILE (LBS. MIN.) | SHEAR (AVG. LBS. ULT.) | TORQUE (MIN. IN. LBS.) |
| 12-14 | 2778 | 2000 | 92 |
| 1/4-14 | 4060 | 2600 | 150 |

| SHEAR VALUES (AVERAGE LBS. ULTIMATE) | | | | | | | | | |
|--------------------------------------|-----|----------------------|-----|-----|-----|------|------|------|------|
| FASTENER | | STEEL GAUGE (LAPPED) | | | | | | | |
| DIA. | PT. | 26 | 24 | 22 | 20 | 18 | 16 | 14 | 12 |
| #12 | 2 | 365 | 600 | 623 | 898 | 1370 | 1758 | 2138 | 2202 |
| #12 | 3 | - | - | - | 769 | 1358 | 1620 | 1970 | 1986 |
| 1/4 | 3 | - | - | - | 930 | 1442 | 2100 | 2584 | 2650 |

| SHEET STEEL GAUGES | | | | | | | | |
|--------------------|-------|-------|-------|-------|-------|-------|-------|-------|
| GAUGE NO. | 26 | 24 | 22 | 20 | 18 | 16 | 14 | 12 |
| DECIMAL EQUIVALENT | .018" | .024" | .030" | .036" | .048" | .060" | .075" | .105" |

The values listed are ultimate averages achieved under laboratory conditions and apply to Buildex manufactured fasteners only. Appropriate safety factors should be applied to these values for design purposes.



TEKS®

HEAVY DUTY SELF-DRILLING FASTENERS

*First in performance! Over 40 years of consistent drilling.
The original self-drillers for heavy duty applications.*

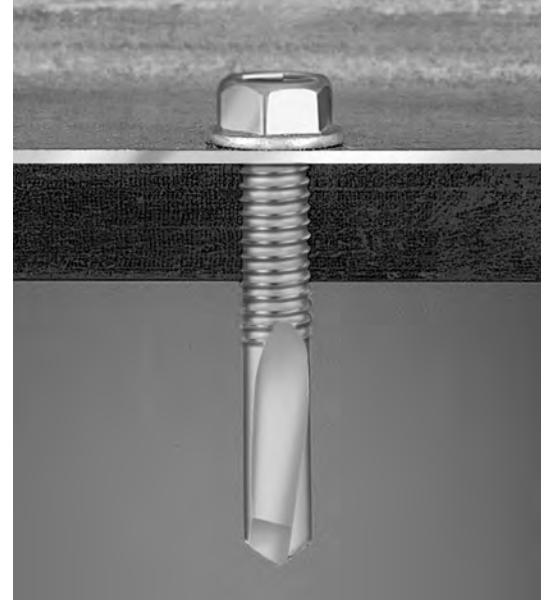

PRODUCT FEATURES

- Engineered for fast drilling and smooth tapping with less effort.
- Climaseal® finish provides excellent corrosion resistance and lower tapping torque.
- Attachments up to 7.15" of material.
- 1/4 Diameter has notched threads to reduce tapping torque.

SELECTOR GUIDE

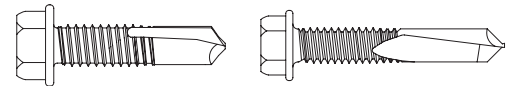

| PART NO. | DESCRIPTION | HEAD STYLE | DRILL POINT | FINISH | DRILL & TAP CAPACITY (IN.) | MAX. MATERIAL ATTACHMENT (IN.) | BOX QTY | APPLICATIONS |
|----------|----------------|------------|-------------|-----------|----------------------------|--------------------------------|---------|---|
| 1088000 | 12-24 x 7/8" | 5/16" HWH | #4 | Climaseal | .125 - .250 | .325 | 5,000 | Metal deck, clips, liner panels or accessories to structural steel or bar joist Longer fasteners can be used in retrofit clip and sheet applications |
| 1414000 | 12-24 x 1-1/4" | 5/16" HWH | #4.5 | Climaseal | .125 - .250 | .575 | 4,000 | |
| 1006000 | 12-24 x 1-1/4" | 5/16" HWH | #5 | Climaseal | .125 - .500 | .375 | 4,000 | |
| 1070000 | 12-24 x 1-1/2" | 5/16" HWH | #5 | Climaseal | .125 - .500 | .625 | 2,500 | |
| 1071000 | 12-24 x 1-1/2" | 3/8" HWH | #5 | Climaseal | .125 - .500 | .625 | 2,000 | |
| 1072000 | 12-24 x 2" | 5/16" HWH | #5 | Climaseal | .125 - .500 | 1.125 | 1,000 | |
| 1074000 | 1/4-28 x 3" | 5/16" HWH | #5 | Climaseal | .125 - .500 | 2.150 | 1,000 | |
| 1075000 | 1/4-28 x 4" | 5/16" HWH | #5 | Climaseal | .125 - .500 | 3.150 | 500 | |
| 1641000 | 1/4-28 x 5" | 3/8" HWH | #5 | Climaseal | .125 - .500 | 4.150 | 250 | |
| 1431000 | 1/4-28 x 6" | 3/8" HWH | #5 | Climaseal | .125 - .500 | 5.150 | 250 | |
| 1590000 | 1/4-28 x 8" | 3/8" HWH | #5 | Climaseal | .125 - .500 | 7.150 | 150 | |

All available with bonded washer



INSTALLATION GUIDELINES

- A standard screwgun with a depth sensitive nosepiece should be used to install TekS. For optimal fastener performance, the screwgun should be a minimum of 6 amps and have a RPM range of 0-2500. (Maximum 1800 RPM is recommended for TekS 5 fasteners)
- Adjust the screwgun nosepiece to properly seat the fastener.
- New magnetic sockets must be correctly set before use. Remove chip build-up as needed.
- The fastener is fully seated when the head is flush with the work surface.
- Overdriving may result in torsional failure of the fastener or stripout of the substrate.
- The fastener must penetrate beyond the metal structure a minimum of 3 pitches of thread.

HEAD STYLE



APPROVALS AND LISTINGS

Factory Mutual (3050495), ICC ESR-3270, ICC ESR-1976

www.itwbuildex.com

PERFORMANCE DATA

| PULLOUT VALUES (AVERAGE LBS. ULTIMATE) | | | | | | |
|--|-----|----|----|------|-------|------|
| FASTENER | | | | | | |
| DIA. | PT. | 16 | 14 | 12 | 3/16" | 1/4" |
| #12 | 4 | - | - | 1532 | 3485 | 3844 |
| #12 | 4.5 | - | - | 1508 | 3865 | 4101 |
| #12 | 5 | - | - | 1527 | 3701 | 3999 |
| 1/4 | 5 | - | - | 1507 | 3300 | 5059 |

| FASTENER VALUES | | | |
|-----------------------|-----------------------------|---------------------------|---------------------------|
| FASTENER (DIA-TPI) | TENSILE (AVG. LBS. ULT.) | SHEAR (AVG. LBS. ULT.) | TORQUE (MIN. IN. LBS.) |
| 12-24 T/4 | 4750 | 2654 | 100 |
| 12-24 T/4.5 | 4750 | 2654 | 100 |
| 12-24 T/5 | 4750 | 2654 | 100 |
| 1/4-28 T/5 | 5577 | 3310 | 234 |

| SHEAR VALUES (AVERAGE LBS. ULTIMATE) | | | | | | |
|--------------------------------------|-----|----------------------|------|------|------|------|
| FASTENER | | STEEL GAUGE (LAPPED) | | | | |
| DIA. | PT. | 16 | 14 | 12 | 1/8" | 1/4" |
| #12 | 4 | - | - | 2048 | 2030 | - |
| #12 | 4.5 | - | - | 2641 | 2887 | 2897 |
| #12 | 5 | - | - | 2650 | 2700 | 2762 |
| 1/4 | 5 | 1597 | 2005 | 2350 | 2792 | 3310 |

| SHEET STEEL GAUGES | | | | | | | | |
|--------------------|-------|-------|-------|-------|-------|-------|-------|-------|
| GAUGE NO. | 26 | 24 | 22 | 20 | 18 | 16 | 14 | 12 |
| DECIMAL EQUIVALENT | .018" | .024" | .030" | .036" | .048" | .060" | .075" | .105" |

Note: Teks fasteners are not categorized as structural bolts. Proper design criteria and strengths must be used for satisfactory application. The values listed are ultimate averages achieved under laboratory conditions and apply to Buildex manufactured fasteners only. Appropriate safety factors should be applied to these values for design purposes.



TEKS® 5.0

HEAVY DUTY SELF-DRILLING FASTENERS

*Faster drilling than the original Tek 5, with the same great performance!
The original self-drillers for heavy duty applications.*



PRODUCT FEATURES

- Patented drill point improves drilling performance in 1/8" through 1/2" steel
- Engineered for fast drilling and smooth tapping with less effort
- Climaseal finish provides excellent corrosion resistance and lower tapping torque

SELECTOR GUIDE

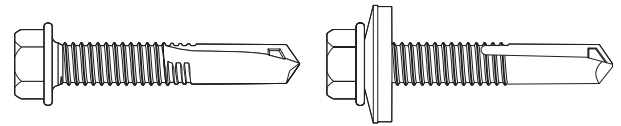

| PART NO. | DESCRIPTION | HEAD STYLE | DRILL POINT | FINISH | DRILL & TAP CAPACITY (IN.) | MAX. MATERIAL ATTACHMENT (IN.) | BOX QTY |
|----------|----------------|------------|-------------|-----------|----------------------------|--------------------------------|---------|
| 1007000 | 12-24 x 1-1/4" | HWH | 5.0 | Climaseal | 0.125 - 0.500 | 0.45 | 4000 |
| 1607000 | 12-24 X 1-1/4" | HWH 2/BD | 5.0 | Climaseal | 0.125 - 0.501 | 0.33 | 2500 |
| 1770000 | 12-24 X 1-1/2" | HWH | 5.0 | Climaseal | 0.125 - 0.502 | 0.7 | 2500 |
| 1670000 | 12-24 X 1-1/2" | HWH w/BD | 5.0 | Climaseal | 0.125 - 0.503 | 0.58 | 2000 |
| 1771000 | 12-24 X 1-1/2" | HWH 3/8 AF | 5.0 | Climaseal | 0.125 - 0.504 | 0.7 | 2500 |
| 1772000 | 12-24 X 2" | HWH | 5.0 | Climaseal | 0.125 - 0.505 | 1.2 | 2000 |
| 1263000 | 12-24 X 2" | Scots | 5.0 | Climaseal | 0.125 - 0.506 | 1.075 | 1500 |



INSTALLATION GUIDELINES

- A standard screwgun with a depth sensitive nosepiece should be used to install Tek 5.0. For optimal fastener performance, the screwgun should be a minimum of 6 amps and have a RPM range of 0-2500. (Maximum 1800 RPM is recommended for Tek 5 fasteners)
- Adjust the screwgun nosepiece to properly seat the fastener.
- New magnetic sockets must be correctly set before use. Remove chip build-up as needed.
- The fastener is fully seated when the head is flush with the work surface.
- Overdriving may result in torsional failure of the fastener or stripout of the substrate.
- The fastener must penetrate beyond the metal structure a minimum of 3 pitches of thread.

HEAD STYLE

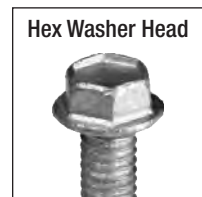

APPROVALS AND LISTINGS

Factory Mutual (3050495), ICC ESR-3270, ICC ESR-1976

PERFORMANCE DATA

| PULLOUT VALUES (AVERAGE LBS. ULTIMATE) | | | | | | |
|--|-----|----|----|------|-------|------|
| FASTENER | | | | | | |
| DIA. | PT. | 16 | 14 | 12 | 3/16" | 1/4" |
| 12 | 5.0 | - | - | 1508 | 3865 | 4101 |

| FASTENER VALUES | | | |
|-----------------------|-----------------------------|---------------------------|---------------------------|
| FASTENER (DIA-TPI) | TENSILE (AVG. LBS. ULT.) | SHEAR (AVG. LBS. ULT.) | TORQUE (MIN. IN. LBS.) |
| 12-24 T/5.0 | 4750 | 2654 | 100 |

| SHEAR VALUES (AVERAGE LBS. ULTIMATE) | | | | | | |
|--------------------------------------|-----|----------------------|----|------|------|------|
| FASTENER | | STEEL GAUGE (LAPPED) | | | | |
| DIA. | PT. | 16 | 14 | 12 | 1/8" | 1/4" |
| 12 | 5.0 | - | - | 2641 | 2887 | 2897 |

| SHEET STEEL GAUGES | | | | | | | | |
|--------------------|-------|-------|-------|-------|-------|-------|-------|-------|
| GAUGE NO. | 26 | 24 | 22 | 20 | 18 | 16 | 14 | 12 |
| DECIMAL EQUIVALENT | .018" | .024" | .030" | .036" | .048" | .060" | .075" | .105" |

Note: Teks fasteners are not categorized as structural bolts. Proper design criteria and strengths must be used for satisfactory application. The values listed are ultimate averages achieved under laboratory conditions and apply to Buildex manufactured fasteners only. Appropriate safety factors should be applied to these values for design purposes.



TEKS[®] SELECT

SELF-DRILLING FASTENERS

Grade 5 performance! TEKS SELECT fasteners have the strength and ductility performance similar to Grade 5 bolts.



PRODUCT FEATURES

- Selectively hardened to eliminate the effects of hydrogen assisted stress corrosion (HASCC).
- Climaseal[®] advanced corrosion resistance coating (ACR) provides the best corrosion resistance available.
- Drill point and thread design enable the TEKS fastener to drill and tap with fewer stalls.

SELECTOR GUIDE



| PART NO. | DESCRIPTION | HEAD STYLE | DRILL POINT | FINISH | DRILL & TAP CAPACITY (IN.) | MAX. MATERIAL ATTACHMENT* (IN.) | APPLICATIONS |
|----------|-----------------|------------|-------------|---------------|----------------------------|---------------------------------|---|
| 1076000 | 10-16 x 3/4" | 5/16" HWH | 3 | Climaseal ACR | .150 | .500 | Glass and metal curtain walls |
| 1080000 | 12-14 x 1" | 5/16" HWH | 3 | Climaseal ACR | .187 | .500 | Designed to meet the challenges of attaching similar or dissimilar metals |
| 1119000 | 1/4-20 x 1" | 3/8" HWH | 3 | Climaseal ACR | .210 | .450 | Grade 5 nut and bolt substitution |
| 1124000 | 1/4-20 x 1-1/8" | 3/8" HWH | 4 | Climaseal ACR | .312 | .500 | Fenestration: Window systems, door systems and glue front systems |
| 1125000 | 1/4-20 x 1-1/2" | 3/8" HWH | 4 | Climaseal ACR | .312 | .830 | Anchoring metal clips to metal structures for masonry facades |
| 1078000 | 1/4-20 x 2" | 3/8" HWH | 4 | Climaseal ACR | .312 | 1.330 | Solar system attachment |

*Maximum material attachment is indicated by arrows.

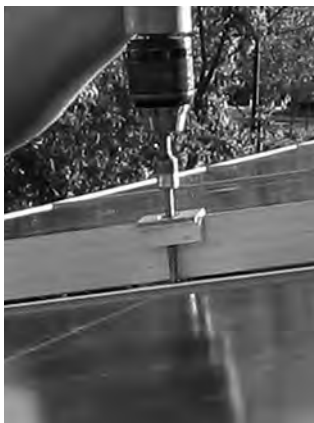

INSTALLATION GUIDELINES

- The screws must be installed perpendicular to the work surface using a screw driving tool. The installation speed for 1/4" screws should not exceed 1,800 RPM. The installation speed for all other screws should not exceed 2,500 RPM.
- Overdriving may result in torsional failure of the fastener or stripout of the substrate.
- The screw must penetrate through the supporting metal with a minimum of three threads protruding past the back side of the supporting metal, or the length which ensures that only the load-bearing area of the screw is engaged in the material being fastened, whichever is greater.
- The fastener must penetrate beyond the metal structure a minimum of 3 threads.

HEAD STYLE



APPROVALS AND LISTINGS

ICC ESR-3223, COLA RR25915

PERFORMANCE DATA

| PULLOUT VALUES (AVERAGE LBS. ULTIMATE) | | | | | | | | | | | | |
|--|-----|----------------|--------------|----------------|--------------|-----------------|------------------|-----------------|------------------|------------------|-----------------|-----------------|
| FASTENER | | STEEL GAUGE | | | | | | | | ALUMINUM 6063-T5 | | |
| DIA. | PT. | 18 45.5 KSI | 16 63 KSI | 14 55.5 KSI | 12 63 KSI | 1/8 56.9 KSI | 3/16 65.3 KSI | 1/4 48.1 KSI | 5/16 49.1 KSI | 1/8 32.4 KSI | 1/4 32.1 KSI | 3/8 27.7 KSI |
| #10 | 3 | 401 | 699 | 1010 | 1680 | 2183 | - | - | - | 745 | - | - |
| #12 | 3 | 400 | 561 | 964 | 1516 | 2149 | 2877 | - | - | 1008 | 2543 | - |

| SHEAR VALUES (AVERAGE LBS. ULTIMATE) | | | | | | | | | | |
|--------------------------------------|-----|---------------|-------|-------|-------|----------|----------|--------|--------------------|---------|
| FASTENER | | STEEL GAUGE** | | | | | | | ALUMINUM 6063-T5** | |
| DIA. | PT. | 18-18 | 18-14 | 16-16 | 14-14 | 1/8-3/16 | 3/16-1/4 | 12-1/4 | 1/8-1/8 | 1/8-1/4 |
| #10 | 3 | 996 | 1872 | 1331 | - | - | - | - | 1526 | - |
| #12 | 3 | 965 | 1803 | 1360 | 1815 | - | - | - | 1846 | 2488 |

** KSI values are the same as listed in the Pullout Values table

| MECHANICAL PROPERTIES | | | |
|-----------------------|-----|---|---|
| FASTENER | | YIELD STRENGTH F _y KSI (MPa) | TENSILE STRENGTH F _u KSI (MPa) |
| DIA. | PT. | | |
| #10 | 3 | 134 ksi (920 MPa) | 152 ksi (1054 MPa) |
| #12 | 3 | 134 ksi (920 MPa) | 152 ksi (1054 MPa) |

| SHEET STEEL GAUGES | | | | | | | | |
|--------------------|-------|-------|-------|-------|-------|-------|-------|-------|
| GAUGE NO. | 26 | 24 | 22 | 20 | 18 | 16 | 14 | 12 |
| DECIMAL EQUIVALENT | .018" | .024" | .030" | .036" | .048" | .060" | .075" | .105" |



TEKS®

LOW PROFILE ARCHITECTURAL METAL ROOF CLIP FASTENERS & RAKE ANGLE SHOULDER TEKS

Incorporates the ITW exclusive Phillips Square-Driv® PSD anti-cam-out system.



PRODUCT FEATURES

- #12 diameter utilizes the ITW exclusive Phillips Square-Driv with patented interlocking components system.
 - Keeps the driver securely mated to the fastener during installation.
 - Hands-free installation.
- #10 Diameter uses the coated Phillips drive system providing improved driver bit to fastener stability and friction fit.
- Sharp convex drill point has precise cutting edges to improve drill performance with less effort.
- Low profile pancake head style ensures proper installation of metal roof panels.

SELECTOR GUIDE

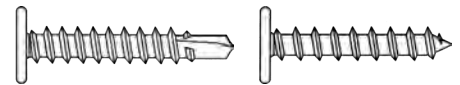

| PART NO. | DESCRIPTION | HEAD STYLE | DRILL POINT | FINISH | DRILL & TAP CAPACITY (IN.) | MAX. MATERIAL ATTACHMENT (IN.) | BOX QTY | APPLICATIONS |
|----------|-------------|---------------------|-------------|-----------|----------------------------|--------------------------------|---------|--|
| 1560553 | 10-16 x 1" | #2 Phillips Pancake | #3 | Climacoat | .036 - .175 | .550 | 4,000 | Low profile architectural metal roof clip to steel purlin |
| 1575553 | 12-14 x 1" | #2 PSD Pancake | #3 | Climacoat | .036 - .210 | .550 | 4,000 | |
| 1596553 | 10-16 x 1" | #2 Phillips Pancake | Type AB | Climacoat | .012 - .048 | .250 | 4,000 | Low profile architectural metal roof clip to wood supports |



INSTALLATION GUIDELINES

- A standard screwgun with a depth-sensitive nosepiece should be used to install TekS. For optimal fastener performance, the screwgun should be a minimum of 6 amps and have an RPM range of 0-2500.
- Adjust the screwgun nosepiece to properly seat the fastener.
- The fastener is fully seated when the head is flush with the work surface.
- Overdriving may result in torsional failure of the fastener or stripout of the substrate.
- The fastener must penetrate a minimum of 3 pitches of thread beyond the metal structure.
- New magnetic sockets must be correctly set before use. Remove chip build-up as needed.

HEAD STYLES

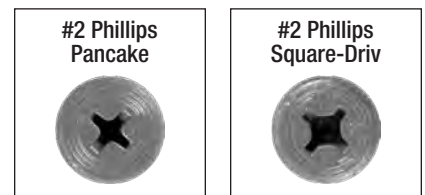

PERFORMANCE DATA

| PULLOUT VALUES - STEEL (AVERAGE LBS. ULTIMATE) | | | | | | | | | |
|--|---------|-------------|-----|-----|-----|-----|-----|-----|------|
| FASTENER | | STEEL GAUGE | | | | | | | |
| DIA. | PT. | 26 | 24 | 22 | 20 | 18 | 16 | 14 | 12 |
| #10 | 3 | 109 | 180 | 218 | 278 | 427 | 583 | 873 | 1406 |
| #12 | 3 | 139 | 194 | 250 | 369 | 450 | 598 | 915 | 1500 |
| #10 | Type AB | 192 | 280 | 360 | 460 | 568 | - | - | - |

| PULLOUT VALUES - WOOD (AVERAGE LBS. ULTIMATE) | | | | | |
|---|---------|-------------------------|--------------|--------------|-------------------------|
| FASTENER | | WOOD TYPE AND THICKNESS | | | |
| DIA. | PT. | 1/2" PLYWOOD | 5/8" PLYWOOD | 3/4" PLYWOOD | YELLOW PINE 5/8" OSB |
| #10 | Type AB | 307 | 487 | 528 | 1164 |

| FASTENER VALUES | | | | |
|-----------------------|---------|------------------------|---------------------------|---------------------------|
| FASTENER (DIA-TPI) | POINT | TENSILE (LBS. MIN.) | SHEAR (AVG. LBS. ULT.) | TORQUE (MIN. IN. LBS.) |
| 10-16 | 3 | 1983 | 1400 | 78 |
| 12-14 | 3 | 2652 | 2000 | 92 |
| 10-16 | Type AB | 1936 | 1526 | 82 |

| SHEAR VALUES (AVERAGE LBS. ULTIMATE) | | | | | |
|--------------------------------------|-----|----------------------|------|------|------|
| FASTENER | | STEEL GAUGE (LAPPED) | | | |
| DIA. | PT. | 20 | 18 | 16 | 14 |
| #10 | 3 | 727 | 1164 | 1366 | 1460 |
| #12 | 3 | 923 | 1279 | 1657 | 1933 |

| SHEET STEEL GAUGES | | | | | | | | | |
|--------------------|-------|-------|-------|-------|-------|-------|-------|-------|--|
| GAUGE NO. | 26 | 24 | 22 | 20 | 18 | 16 | 14 | 12 | |
| DECIMAL EQUIVALENT | .018" | .024" | .030" | .036" | .048" | .060" | .075" | .105" | |

The values listed are ultimate averages achieved under laboratory conditions and apply to Buildex manufactured fasteners only. Appropriate safety factors should be applied to these values for design purposes.



TEKS®

WOOD-TO-METAL FASTENERS

No pre-drilling, fast, efficient attachment of wood to steel.



PRODUCT FEATURES

- Point has precise cutting edges to improve drill performance with less effort.
- Special winged fasteners ream a hole in wood preventing thread engagement during drilling.
- Wafer head design has a large bearing surface ideal for plywood.
- Flat head design countersinks and seats flush in wood.
- Gray Climaseal® finish provides excellent corrosion resistance and lower tapping torque.

SELECTOR GUIDE

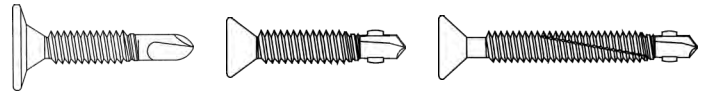

| PART NO. | DESCRIPTION | HEAD STYLE | DRILL POINT | FINISH | DRILL & TAP CAPACITY (IN.) | MAX. MATERIAL ATTACHMENT (IN.) | BOX QTY | APPLICATIONS |
|----------|------------------|-------------------|-------------|----------------|----------------------------|--------------------------------|---------|--|
| 1791000 | 10-16 x 1-13/16" | **#2 PSD Flat | #3 | Gray Climaseal | .030 - .175 | 1/4" - 3/4" | 2,500 | Plywood, mansard, fascia, roofing, flooring to steel framing |
| 1079000 | 10-24 x 1" | #2 Phillips Wafer | #3 | Gray Climaseal | .030 - .175 | 1/4" - 1/2" | 5,000 | |
| †1082000 | 10-24 x 1-7/16" | #2 PFH | #3 | Gray Climaseal | .060 - .175 | 1/4" - 3/4" | 3,000 | Plywood, 2 x 4's headers to steel framing |
| †1552500 | 12-24 x 1-5/8" | #3 PFH | #4 | Gray Climaseal | .125 - .250 | 3/4" - 1-1/4" | 2,000 | |
| †1092000 | 12-24 x 2-1/4" | #3 PFH | #4 | Gray Climaseal | .125 - .250 | 3/4" - 1-3/8" | 2,000 | |
| †1094000 | 12-24 x 2-3/4" | #3 PFH | #4 | Gray Climaseal | .125 - .250 | 3/4" - 1-5/8" | 1,500 | 2 x 4's to steel framing |
| †1096000 | 1/4-20 x 3" | #3 PFH | #4 | Gray Climaseal | .125 - .250 | 3/4" - 2" | 1,000 | |

†With wings **With ribs under head



INSTALLATION GUIDELINES

- A standard screwgun with a depth sensitive nosepiece should be used to install Tek's. For optimal fastener performance, the screwgun should be a minimum of 6 amps and have an RPM range of 0-2500.
- Adjust the screwgun nosepiece to properly seat the fastener.
- Worn or damaged bit tip should be replaced.
- The fastener is fully seated when the head is flush with the work surface.
- Overdriving may result in torsional failure of the fastener or stripout of the substrate.
- The fastener must penetrate beyond the metal structure a minimum of 3 pitches of thread.
- All #10 diameter "Winged" parts must be driven into a minimum of 16 GA steel thickness.
- All 1/4 and #12 diameter "Winged" parts must be driven into a minimum of 1/8" steel in order to break the wings consistently.

HEAD STYLES

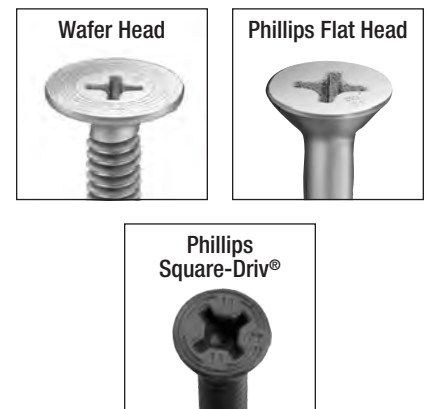

PERFORMANCE DATA

| PULLOUT VALUES (AVERAGE LBS. ULTIMATE) | | | | | | | | | | | |
|--|-----|-------------|-----|-----|-----|-----|-----|-----|------|-------|------|
| FASTENER | | STEEL GAUGE | | | | | | | | | |
| DIA. | PT. | 26 | 24 | 22 | 20 | 18 | 16 | 14 | 12 | 3/16" | 1/4" |
| #10-16 | 3 | - | 208 | 266 | 299 | 499 | 708 | 967 | 1474 | - | - |
| #10-24 | 3 | - | - | - | 334 | 495 | 702 | 900 | 1570 | - | - |
| #12-24 | 4 | - | - | - | - | - | - | - | 1508 | 3865 | 4101 |
| 1/4 | 4 | - | - | - | - | - | - | - | 1803 | 4297 | - |

| FASTENER VALUES | | | |
|-----------------------|------------------------|---------------------------|---------------------------|
| FASTENER (DIA-TPI) | TENSILE (LBS. MIN.) | SHEAR (AVG. LBS. ULT.) | TORQUE (MIN. IN. LBS.) |
| 10-16 | 1936 | 1400 | 61 |
| 10-24 | 2702 | 1500 | 65 |
| 12-24 | 3165 | 2200 | 150 |
| 1/4-20 | 3860 | 2700 | 168 |

| SHEAR VALUES (AVERAGE LBS. ULTIMATE) | | | | | | | |
|--------------------------------------|-----|----------------------|------|------|------|------|------|
| FASTENER | | STEEL GAUGE (LAPPED) | | | | | |
| DIA. | PT. | 20 | 18 | 16 | 14 | 12 | 1/8 |
| #10 | 3 | 728 | 1266 | 1540 | 1522 | - | - |
| #12 | 4 | - | - | - | - | 2048 | 2030 |
| 1/4 | 4 | - | - | - | - | 2650 | 2820 |

| SHEET STEEL GAUGES | | | | | | | | |
|--------------------|-------|-------|-------|-------|-------|-------|-------|-------|
| GAUGE NO. | 26 | 24 | 22 | 20 | 18 | 16 | 14 | 12 |
| DECIMAL EQUIVALENT | .018" | .024" | .030" | .036" | .048" | .060" | .075" | .105" |

The values listed are ultimate averages achieved under laboratory conditions and apply to Buildex manufactured fasteners only. Appropriate safety factors should be applied to these values for design purposes.

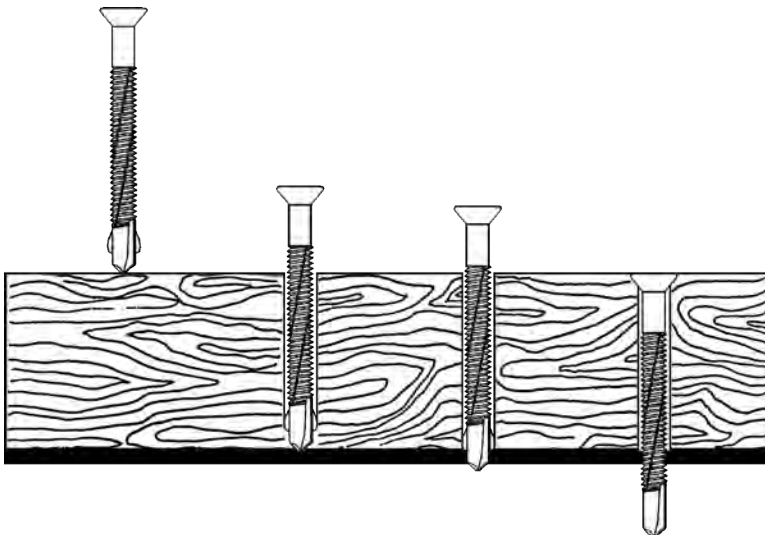

TEKS®

SELF-DRILLING FASTENERS WITH BONDED WASHER

For weather-tight sealing of roof and wall applications

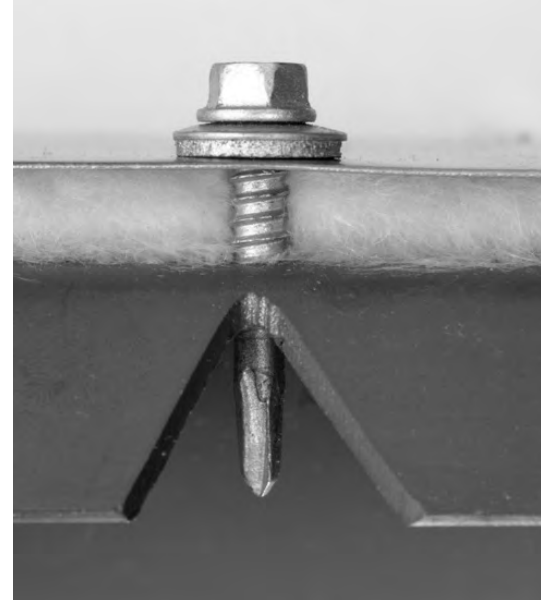

PRODUCT FEATURES

- Vulcanized bonding of washer eliminates separation of EPDM from the metal backing.
- Dual sealing bonded washer prevents leaks.
- Climaseal® finish provides excellent corrosion resistance and lower tapping torque.
- Point has precise cutting edges to improve drill performance with less effort.
- Point to thread design maximizes pullout performance and minimizes backout.

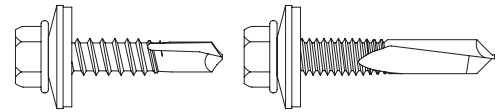

SELECTOR GUIDE

| PART NO. | DESCRIPTION | HEAD STYLE | DRILL POINT | FINISH | DRILL & TAP CAPACITY (IN.) | MAX. MATERIAL ATTACHMENT (IN.) | BOX QTY | APPLICATIONS |
|----------|-----------------|------------|-------------|-----------|----------------------------|--------------------------------|---------|---|
| 1005000 | 10-16 x 3/4" | 5/16" HWH | #3 | Climaseal | .036 - .175 | .205 | 3,000 | Brick tie to steel framing |
| 1308000 | 10-16 x 1-1/2" | 5/16" HWH | #3 | Climaseal | .036 - .175 | .955 | 2,500 | |
| 1009000 | 12-14 x 3/4" | 5/16" HWH | #3 | Climaseal | .036 - .210 | .150 | 3,000 | Wall panel to girt |
| 1011000 | 12-14 x 1" | 5/16" HWH | #3 | Climaseal | .036 - .210 | .400 | 3,000 | |
| 1404000 | 12-14 x 1-1/2" | 5/16" HWH | #2 | Climaseal | .036 - .210 | .680 | 2,000 | Stitch roof and wall panels |
| 1016000 | 12-14 x 2" | 5/16" HWH | #3 | Climaseal | .036 - .210 | 1.330 | 1,500 | |
| 1333000 | 12-14 x 3" | 5/16" HWH | #3 | Climaseal | .036 - .210 | 2.330 | 1,000 | Mansard panel to steel framing |
| †1416000 | 1/4-14 x 7/8" | 5/16" HWH | #1 | Climaseal | .018 - .095 | .260 | 3,000 | |
| 1160000 | 1/4-14 x 1" | 5/16" HWH | #3 | Climaseal | .036 - .210 | .280 | 2,500 | Roof panel to purlin |
| 1019000 | 1/4-14 x 1-1/4" | 5/16" HWH | #3 | Climaseal | .036 - .210 | .530 | 2,000 | |
| 1021000 | 1/4-14 x 2" | 5/16" HWH | #3 | Climaseal | .036 - .210 | 1.280 | 1,000 | Retrofit panels to structural |
| 1010000 | 12-24 x 7/8" | 5/16" HWH | #4 | Climaseal | .125 - .250 | .205 | 3,000 | |
| 1415000 | 12-24 x 1-1/4" | 5/16" HWH | #4.5 | Climaseal | 125 - .375 | .455 | 2,500 | Longer fasteners may be used in retrofit applications |
| 1000000 | 12-24 x 1-1/4" | 5/16" HWH | #5 | Climaseal | 125 - .500 | .255 | 2,500 | |
| 1001000 | 12-24 x 1-1/2" | 5/16" HWH | #5 | Climaseal | 125 - .500 | .505 | 2,000 | |
| 1002000 | 12-24 x 2" | 5/16" HWH | #5 | Climaseal | 125 - .500 | 1.005 | 1,500 | |
| 1003000 | 1/4-28 x 3" | 5/16" HWH | #5 | Climaseal | 125 - .500 | 2.030 | 1,000 | |
| 1004000 | 1/4-28 x 4" | 5/16" HWH | #5 | Climaseal | 125 - .500 | 3.030 | 500 | |
| *1647000 | 1/4-28 x 5" | 3/8" HWH | #5 | Climaseal | 125 - .500 | 4.030 | 250 | |
| *1619000 | 1/4-28 x 8" | 3/8" HWH | #5 | Climaseal | 125 - .500 | 7.030 | 150 | |

†With ABOT™ (Anti-backout threadform) *3/4" Bonded Washer



INSTALLATION GUIDELINES

- A standard screwgun with a depth sensitive nosepiece should be used to install TekS. For optimal fastener performance, the screwgun should be a minimum of 6 amps and have an RPM range of 0-2500. A maximum 1800 RPM is recommended for TekS fasteners.
- New magnetic sockets must be correctly set before use. Remove chip build-up as needed.
- Adjust the screwgun nosepiece to properly seat the fastener.
- Overdriving may result in torsional failure of the fastener or stripout of the substrate.
- The fastener must penetrate beyond the metal structure a minimum of 3 pitches of thread.



HEAD STYLE

Hex Washer Head with Bonded Washer



www.itwbuildex.com

PERFORMANCE DATA

| PULLOUT VALUES (AVERAGE LBS. ULTIMATE) | | | | | | | | | | | |
|--|-----|-------------|-----|-----|-----|-----|------|------|------|-------|------|
| FASTENER | | STEEL GAUGE | | | | | | | | | |
| DIA. | PT. | 26 | 24 | 22 | 20 | 18 | 16 | 14 | 12 | 3/16" | 1/4" |
| 10 | 3 | 124 | 208 | 266 | 299 | 499 | 708 | 967 | 1474 | - | - |
| 12 | 2 | 156 | 243 | 283 | 375 | 605 | 848 | 1181 | 1856 | 3520 | - |
| 12 | 3 | 142 | 211 | 289 | 341 | 551 | 757 | 1063 | 1631 | 2998 | - |
| 12 | 4 | - | - | - | - | - | - | - | 1532 | 3485 | 3844 |
| 12 | 4.5 | - | - | - | - | - | - | - | 1508 | 3865 | 4104 |
| 12 | 5 | - | - | - | - | - | - | - | 1527 | 3701 | 3999 |
| 1/4 | 1 | 208 | 329 | 428 | 562 | 800 | 1151 | - | - | - | - |
| 1/4 | 3 | 141 | 231 | 293 | 346 | 613 | 880 | 1146 | 1877 | 4550 | - |
| 1/4 | 5 | - | - | - | - | - | 607 | 918 | 1507 | 3300 | 5059 |

| FASTENER VALUES | | | |
|-----------------------|-----------------------------|---------------------------|---------------------------|
| FASTENER (DIA-TPI) | TENSILE (AVG. LBS. ULT.) | SHEAR (AVG. LBS. ULT.) | TORQUE (MIN. IN. LBS.) |
| 10-16 | 1936 | 1400 | 61 |
| 12-14 | 2778 | 2000 | 92 |
| 12-24 | 4750 | 2654 | 100 |
| 1/4-14 | 4060 | 2600 | 150 |
| 1/4-28 | 5577 | 3310 | 234 |

| SHEAR VALUES (AVERAGE LBS. ULTIMATE) | | | | | | | | | | | |
|--------------------------------------|-----|----------------------|-----|-----|------|------|------|------|------|-------|------|
| FASTENER | | STEEL GAUGE (LAPPED) | | | | | | | | | |
| DIA. | PT. | 26 | 24 | 22 | 20 | 18 | 16 | 14 | 12 | 3/16" | 1/4" |
| 10 | 3 | - | 445 | 526 | 728 | 1266 | 1540 | 1552 | - | - | - |
| 12 | 2 | 365 | 600 | 623 | 898 | 1370 | 1758 | 2138 | - | - | - |
| 12 | 3 | - | - | - | 769 | 1358 | 1620 | 1970 | 1986 | - | - |
| 12 | 4 | - | - | - | - | - | - | - | 2048 | 2030 | - |
| 12 | 4.5 | - | - | - | - | - | - | - | 2641 | 2887 | - |
| 12 | 5 | - | - | - | - | - | - | - | 2650 | 2700 | - |
| 1/4 | 1 | 511 | 849 | 885 | 1244 | 1764 | - | - | - | - | - |
| 1/4 | 3 | - | - | - | 930 | 1442 | 2100 | 2584 | 2650 | - | - |
| 1/4 | 5 | - | - | - | - | - | 1597 | 2005 | 2350 | 2792 | 3310 |

The values listed are ultimate averages achieved under laboratory conditions and apply to Buildex manufactured fasteners only. Appropriate safety factors should be applied to these values for design purposes.

| SHEET STEEL GAUGES | | | | | | | | |
|--------------------|-------|-------|-------|-------|-------|-------|-------|-------|
| GAUGE NO. | 26 | 24 | 22 | 20 | 18 | 16 | 14 | 12 |
| DECIMAL EQUIVALENT | .018" | .024" | .030" | .036" | .048" | .060" | .075" | .105" |



MAXISEAL®

INTEGRAL WASHER SYSTEM

Maxiseal... The premium sealing system for Tek® self-drilling, self-tapping fasteners



PRODUCT FEATURES

- Controls the EPDM rubber washer for improved in place appearance and increased washer life.
- Seals when driven at an angle.
- Optimum pullover resistance.
- Hex washer head provides excellent driving stability.
- Point has precise cutting edges to improve drill performance with less effort.
- Non-walking point provides fast material engagement.
- Point to thread design maximizes pullout performance and minimizes backout.
- Drills and taps in the broadest range of applications.
- Climaseal® finish provides excellent corrosion resistance and lower tapping torque.

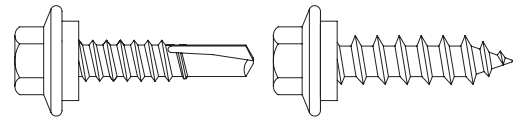

SELECTOR GUIDE

| PART NO. | DESCRIPTION | HEAD STYLE | DRILL POINT | FINISH | DRILL & TAP CAPACITY (IN.) | MAX. MATERIAL ATTACHMENT (IN.) | BOX QTY | APPLICATIONS |
|----------|-----------------|------------|-------------|-----------|----------------------------|--------------------------------|---------|--|
| 1376000 | 10-16 x 3/4" | 5/16" HWH | #3 | Climaseal | .036 - .175 | .325 | 3,000 | Roof and wall panel to steel framing Panel over insulation to steel framing |
| 1023000 | 12-14 x 3/4" | 5/16" HWH | #3 | Climaseal | .036 - .210 | .260 | 3,000 | |
| 1026000 | 12-14 x 1" | 5/16" HWH | #3 | Climaseal | .036 - .210 | .490 | 2,500 | |
| 1029000 | 12-14 x 1-1/4" | 5/16" HWH | #2 | Climaseal | .036 - .210 | .560 | 2,500 | |
| 1428000 | 12-14 x 1-1/2" | 5/16" HWH | #2 | Climaseal | .036 - .210 | .790 | 2,000 | Stitching roof, wall, fascia, or eave panels |
| †1389000 | 1/4-14 x 7/8" | 5/16" HWH | #1 | Climaseal | .036 - .095 | .320 | 3,000 | |
| 1044000 | 1/4-14 x 1" | 3/8" HWH | #3 | Climaseal | .036 - .210 | .310 | 2,500 | Sheet or accessories with up to 6" blanket insulation to steel framing |
| 1048000 | 1/4-14 x 1-1/2" | 3/8" HWH | #3 | Climaseal | .036 - .210 | .810 | 2,000 | |
| 1018000 | 1/4-14 x 1-3/4" | 3/8" HWH | #3 | Climaseal | .036 - .210 | 1.060 | 1,500 | |
| 1063053 | 17-14 x 1" | 5/16" HWH | AB | Climaseal | — | .685 | 2,500 | Replacement screw for 12 and 1/4" diameter |

†With ABOT™ (Anti-backout threadform)



INSTALLATION GUIDELINES

- A standard screwgun with a depth sensitive nosepiece should be used to install Tek®. For optimal fastener performance, the screwgun should be a minimum of 6 amps and have an RPM range of 0-2500.
- Adjust the screwgun nosepiece to properly seat the fastener.
- New magnetic sockets must be correctly set before use. Remove chip build up as needed.
- Overdriving may result in torsional failure of the fastener or stripout of the substrate.
- The fastener must penetrate beyond the metal structure a minimum of 3 pitches of thread.

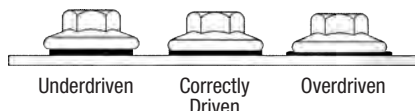

HEAD STYLE



PERFORMANCE DATA

| PULLOUT VALUES (AVERAGE LBS. ULTIMATE) | | | | | | | | | | | |
|--|-----|-------------|-----|-----|-----|-----|------|------|------|-------|------|
| FASTENER | | STEEL GAUGE | | | | | | | | | |
| DIA. | PT. | 26 | 24 | 22 | 20 | 18 | 16 | 14 | 12 | 3/16" | 1/4" |
| 10 | 3 | 124 | 208 | 266 | 299 | 499 | 708 | 967 | 1474 | 3520 | - |
| 12 | 2 | 156 | 243 | 283 | 375 | 605 | 848 | 1181 | 1856 | 2998 | - |
| 12 | 3 | 142 | 211 | 289 | 341 | 551 | 757 | 1063 | 1631 | 3485 | - |
| 1/4 | 1 | 208 | 329 | 428 | 562 | 800 | 1151 | - | 1877 | 3523 | - |
| 1/4 | 3 | 141 | 231 | 293 | 346 | 613 | 880 | 1145 | 1716 | - | - |
| 17 | AB | 225 | 261 | 350 | 442 | 553 | 752 | 1122 | - | - | - |

| FASTENER VALUES | | | |
|-----------------------|------------------------|---------------------------|---------------------------|
| FASTENER (DIA-TPI) | TENSILE (LBS. MIN.) | SHEAR (AVG. LBS. ULT.) | TORQUE (MIN. IN. LBS.) |
| 10-16 | 1936 | 1400 | 61 |
| 12-14 | 2778 | 2000 | 92 |
| 1/4-14 | 4060 | 2600 | 150 |
| 17-14 | 5300 | 3200 | 180 |

| SHEAR VALUES (AVERAGE LBS. ULTIMATE) | | | | | | | | | | |
|--------------------------------------|-----|----------------------|-----|-----|------|------|------|------|------|--|
| FASTENER | | STEEL GAUGE (LAPPED) | | | | | | | | |
| DIA. | PT. | 26 | 24 | 22 | 20 | 18 | 16 | 14 | 12 | |
| 10 | 3 | - | 445 | 526 | 728 | 1266 | 1540 | 1552 | - | |
| 12 | 2 | 365 | 600 | 623 | 898 | 1370 | 1758 | 2138 | - | |
| 12 | 3 | - | - | - | 769 | 1358 | 1620 | 1970 | 1986 | |
| 1/4 | 1 | 511 | 849 | 885 | 1244 | 1765 | - | - | - | |
| 1/4 | 3 | - | - | - | 930 | 1442 | 2100 | 2584 | 2650 | |
| 17 | AB | 459 | 745 | 989 | 958 | 1415 | - | - | - | |

| SHEET STEEL GAUGES | | | | | | | | | |
|--------------------|-------|-------|-------|-------|-------|-------|-------|-------|--|
| GAUGE NO. | 26 | 24 | 22 | 20 | 18 | 16 | 14 | 12 | |
| DECIMAL EQUIVALENT | .018" | .024" | .030" | .036" | .048" | .060" | .075" | .105" | |

The values listed are ultimate averages achieved under laboratory conditions and apply to Buildex manufactured fasteners only. Appropriate safety factors should be applied to these values for design purposes.



SCOTS®

LONG LIFE TEKS FASTENER

The Original Buildex Scots 300 Stainless Steel Encapsulated Head will never rust... ever!!!



PRODUCT FEATURES

- For improved appearance and extra life, an integral design controls the EPDM rubber washer.
- Combines 300 series stainless steel exterior with the strength of carbon steel.
- 300 series stainless most preferred for galvalume long life panels.
- Maximum sealing and corrosion protection.
- Point has precise cutting edges to improve drill performance with less effort.
- Non-walking point provides fast material engagement.
- Point to thread design maximizes pullout performance and minimizes backout.
- Drills and taps in the broadest range of applications.

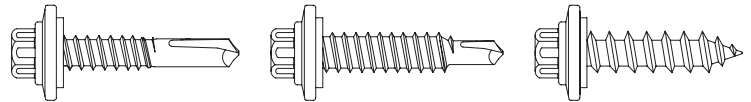

SELECTOR GUIDE

| PART NO. | DESCRIPTION | HEAD STYLE | DRILL POINT | FINISH | DRILL & TAP CAPACITY (IN.) | MAX. MATERIAL ATTACHMENT (IN.) | BOX QTY | APPLICATIONS |
|----------|-----------------|------------|-------------|-----------|----------------------------|--------------------------------|---------|--|
| 1165253 | 12-14 x 1" | 5/16" HWH | #3 | Climaseal | .036 - .210 | .310 | 2,500 | Panel over blanket insulated to steel frame |
| 1167253 | 12-14 x 1-1/4" | 5/16" HWH | #2 | Climaseal | .036 - .210 | .560 | 2,500 | |
| 1168254 | 12-14 x 1-1/2" | 5/16" HWH | #2 | Climaseal | .036 - .210 | .790 | 2,000 | |
| 1163000 | 12-24 x 2" | 5/16" HWH | #5 | Climaseal | .125 - .500 | 1.000 | 1,500 | Roof curb to structural frame |
| †1095253 | 1/4-14 x 7/8" | 5/16" HWH | #1 | Climaseal | .018 - .095 | .320 | 2,500 | Standing seam roof system endlaps Stitch roof and wall sidelaps. SSR endlaps. |
| †1175153 | 1/4-14 x 1-1/8" | 5/16" HWH | #1 | Climaseal | .018 - .095 | .395 | 2,500 | |
| 1616000 | 1/4-14 x 1-1/4" | 5/16" HWH | #3 | Climaseal | .036 - .210 | .630 | 2,000 | |
| †1180225 | 17-14 x 1" | 5/16" HWH | AB | Climaseal | - | .686 | 1,500 | Replacement screw for 12 and 1/4" diameter |

†With ABOT™ (Anti-backout threadform)



INSTALLATION GUIDELINES

- A standard screwgun with a depth sensitive nosepiece should be used to install Teks®. For optimal fastener performance, the screwgun should be a minimum of 6 amps and have an RPM range of 0-2500. Maximum 1800 RPM is recommended for Teks 5 fasteners.
- Adjust the screwgun nosepiece to properly seat the fastener.
- New magnetic sockets must be correctly set before use. Remove chip build-up as needed.
- Overdriving may result in torsional failure of the fastener or stripout of the substrate.
- The fastener must penetrate beyond the metal structure a minimum of 3 pitches of thread.

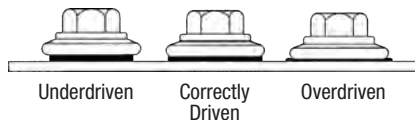

HEAD STYLE



PERFORMANCE DATA

| PULLOUT VALUES (AVERAGE LBS. ULTIMATE) | | | | | | | | | | | |
|--|-----|-------------|-----|-----|-----|-----|------|------|------|-------|------|
| FASTENER | | STEEL GAUGE | | | | | | | | | |
| DIA. | PT. | 26 | 24 | 22 | 20 | 18 | 16 | 14 | 12 | 3/16" | 1/4" |
| 12 | 2 | 156 | 243 | 283 | 375 | 605 | 848 | 1181 | 1856 | 3520 | - |
| 12 | 3 | 141 | 231 | 293 | 346 | 613 | 880 | 1145 | 1858 | 4555 | - |
| 12 | 5 | - | - | - | - | - | - | - | 1527 | 3701 | 3999 |
| 1/4 | 1 | 208 | 329 | 428 | 562 | 800 | 1151 | - | - | - | - |
| 1/4 | 3 | 141 | 231 | 293 | 346 | 613 | 880 | 1145 | 1858 | 4550 | - |
| 17 | AB | 225 | 261 | 350 | 442 | 553 | 752 | 1122 | 1716 | 3523 | 4250 |

| FASTENER VALUES | | | |
|-----------------------|-----------------------------|---------------------------|---------------------------|
| FASTENER (DIA-TPI) | TENSILE (AVG. LBS. ULT.) | SHEAR (AVG. LBS. ULT.) | TORQUE (MIN. IN. LBS.) |
| 12-14 | 2778 | 2000 | 92 |
| 12-24 | 4750 | 2654 | 100 |
| 1/4-14 | 4060 | 2600 | 150 |
| 17-14 | 5300 | 3200 | 180 |

| SHEAR VALUES (AVERAGE LBS. ULTIMATE) | | | | | | | | | | | |
|--------------------------------------|-----|----------------------|-----|-----|------|------|------|------|------|-------|------|
| FASTENER | | STEEL GAUGE (LAPPED) | | | | | | | | | |
| DIA. | PT. | 26 | 24 | 22 | 20 | 18 | 16 | 14 | 12 | 3/16" | 1/4" |
| 12 | 2 | 365 | 600 | 623 | 898 | 1370 | 1758 | 2138 | 2202 | - | - |
| 12 | 3 | - | - | - | 769 | 1358 | 1620 | 1970 | 1986 | - | - |
| 12 | 5 | - | - | - | - | - | - | - | 2700 | 2720 | 2762 |
| 1/4 | 1 | 511 | 849 | 885 | 1244 | 1764 | - | - | - | - | - |
| 1/4 | 3 | - | - | - | 930 | 1442 | 2100 | 2584 | - | - | - |
| 17 | AB | 459 | 745 | 989 | 958 | 1415 | - | - | - | - | - |

| SHEET STEEL GAUGES | | | | | | | | |
|--------------------|-------|-------|-------|-------|-------|-------|-------|-------|
| GAUGE NO. | 26 | 24 | 22 | 20 | 18 | 16 | 14 | 12 |
| DECIMAL EQUIVALENT | .018" | .024" | .030" | .036" | .048" | .060" | .075" | .105" |

The values listed are ultimate averages achieved under laboratory conditions and apply to Buildex manufactured fasteners only. Appropriate safety factors should be applied to these values for design purposes.



TRUGRIP™

METAL-TO-WOOD FASTENERS

The preferred fastener by the leading post frame builders and manufacturers.



PRODUCT FEATURES

- Non-walking sharp point for fast material engagement.
- EPDM bonded washer prevents leaks.
- Vulcanized bonding of washer eliminates separation of EPDM from the metal backing.
- High-hat HWH for driving stability.
- Climaseal® finish provides excellent corrosion resistance and lower tapping torque.

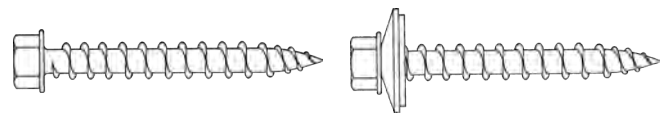

SELECTOR GUIDE

| PART NO. | DESCRIPTION | HEAD STYLE | DRILL POINT | FINISH | DRILL & TAP CAPACITY (IN.) | MAX. MATERIAL ATTACHMENT (IN.) | BOX QTY | APPLICATIONS |
|--------------------------------|----------------|------------|-------------|-----------|----------------------------|--------------------------------|---------|---|
| 1271000 | 9-15 x 1" | 1/4" HWH | Sharp | Climaseal | .012 - .048 | 0 - .250 | 7,000 | Metal wall panel to wood structure Metal panel over insulation to wood |
| 1272000 | 9-15 x 1-1/2" | 1/4" HWH | Sharp | Climaseal | .012 - .048 | 0 - .750 | 4,000 | |
| 1276000 | 9-15 x 3" | 1/4" HWH | Sharp | Climaseal | .012 - .048 | 1.500 - 2.250 | 1,500 | |
| WITH 1/2" BONDED WASHER | | | | | | | | |
| 1262000 | 9-15 x 1" | 1/4" HWH | Sharp | Climaseal | .012 - .048 | 0 - .250 | 4,000 | Metal roof and wall panel to wood Metal panel over insulation to wood |
| 1264000 | 9-15 x 1-1/2" | 1/4" HWH | Sharp | Climaseal | .012 - .048 | 0 - .750 | 2,500 | |
| 1267000 | 9-15 x 2" | 1/4" HWH | Sharp | Climaseal | .012 - .048 | .500 - 1.250 | 2,000 | |
| 1268000 | 9-15 x 2-1/2" | 1/4" HWH | Sharp | Climaseal | .012 - .048 | 0 - .250 | 1,500 | |
| 1269000 | 9-15 x 3" | 1/4" HWH | Sharp | Climaseal | .012 - .048 | 1.500 - 2.250 | 1,000 | |
| 1526053 | 14-10 x 1-1/2" | 5/16" HWH | Type 17 | Climaseal | .012 - .048 | 0 - .750 | 2,000 | |



INSTALLATION GUIDELINES

- A standard screwgun with a depth sensitive nosepiece should be used to install TruGrip. For optimal fastener performance, the screwgun should be a minimum of 6 amps and have an RPM range of 0-2500.
- Adjust the screwgun nosepiece to properly seat the fastener.
- New magnetic sockets must be correctly set before use. Remove chip build-up as needed.
- Overdriving may result in torsional failure of the fastener or stripout of the substrate.
- The fastener must penetrate beyond the metal structure a minimum of 3 pitches of thread.

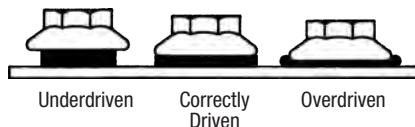

HEAD STYLES

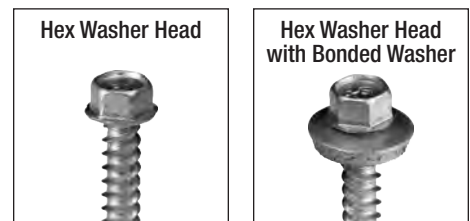

PERFORMANCE DATA

| PULLOUT VALUES IN STEEL (AVERAGE LBS. ULTIMATE) | | | | | |
|---|-------------|-----|-----|-----|-----|
| FASTENER DIA. | STEEL GAUGE | | | | |
| | 26 | 24 | 22 | 20 | 18 |
| 9 | 171 | 252 | 329 | 401 | 634 |

| PULLOUT VALUES IN WOOD (AVERAGE LBS. ULTIMATE) | | | | | |
|--|----------------------|------|-----|--------|--------|
| FASTENER DIA. | EMBEDMENT IN 2" X 4" | | | | |
| | 1/2" | 3/4" | 1" | 1-1/4" | 1-1/2" |
| 9 | 198 | 328 | 571 | 728 | 872 |

| FASTENER VALUES | | | |
|-----------------------|------------------------|---------------------------|---------------------------|
| FASTENER (DIA-TPI) | TENSILE (LBS. MIN.) | SHEAR (AVG. LBS. ULT.) | TORQUE (MIN. IN. LBS.) |
| 9-15 | 1,800 | 1,200 | 50 |
| 14-10 | 4,060 | 2,600 | 150 |

| PULLOVER VALUES (AVERAGE LBS. ULTIMATE) | | | | | | |
|---|----------|-------------|-----|-----|------|------|
| FASTENER | | STEEL GAUGE | | | | |
| DIA. | | 26 | 24 | 22 | 20 | 18 |
| 9 | Unwashed | 465 | 623 | 815 | 1049 | 1549 |
| 9 | Washed | 515 | 674 | 875 | 1100 | 1627 |

| SHEET STEEL GAUGES | | | | | | | |
|--------------------|------|------|-------|-------|-------|-------|-------|
| GAUGE NO. | 30 | 28 | 26 | 24 | 22 | 20 | 18 |
| DECIMAL EQUIVALENT | .012 | .015 | .018" | .024" | .030" | .036" | .048" |

The values listed are ultimate averages achieved under laboratory conditions and apply to Buildex manufactured fasteners only. Appropriate safety factors should be applied to these values for design purposes.



DEKTITE®

PIPE FLASHING

The original flexible pipe flashing system with a 20 year warranty.



PRODUCT FEATURES

- Made of long life, flexible, weatherproof gray EPDM rubber.
- Flexible, corrosion resistant aluminum base conforms to any panel configuration.
- EPDM will not crack or break.
- Pipe diameter markings are clearly indicated for accurate fitting.
- Designed for 1/4" to 13" diameter pipes.
- One piece construction is easy to install.
- Pleated cone adjusts to any roof pitch and allows for complete flexibility.
- EPDM has a continuous service temperature range of -65°F to +250°F (grey in color).
- Proven resistance to ozone and ultra-violet light.

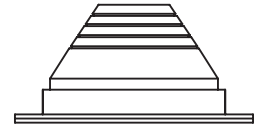

SELECTOR GUIDE

| PART NO. | DESCRIPTION | PIPE OUTSIDE DIAMETER (IN.) | DEKTITE BASE DIAMETER (IN.) | DEKTITE HEIGHT (IN.) | BOX QTY | APPLICATIONS |
|----------|-------------|-----------------------------|-----------------------------|----------------------|---------|--|
| 4003910 | 1 | 1/4 - 2 | 4-3/4 | 3 | 10 | Plumbing, Heating, Air Conditioning, Electrical and Exhaust Vents. |
| 4004910 | 2 | 1-3/4 - 3-1/4 | 6-1/4 | 4 | 10 | |
| 4009910 | 3 | 1/4 - 5 | 7-3/4 | 4 | 10 | |
| 4011910 | 4 | 3 - 6 | 9-1/4 | 5 | 10 | |
| 4016910 | 5 | 4 - 7 | 10-3/4 | 5 | 5 | |
| 4025910 | 8 | 7 - 13 | 16-1/2 | 6 | 5 | |

Note: When used on roofs where pitch is steeper than 20 degrees, or when used on deep ribbed profile roof panel (1-1/2" deep corrugation or more), consider using next larger size Dektite that will accommodate the same pipe diameter.

PERFORMANCE DATA

| ASTM METHOD | TEST DESCRIPTION | SPECIFICATION | TEST RESULTS |
|-------------|---|----------------------------------|----------------|
| D412 | Tensile Strength (min. psi rating) | 1450 psi min. | 1537 psi |
| D412 | Ultimate Elongation (%) | 350 min. | 535 |
| D1171 | Resistance to Ozone— min. rating | 100 (no cracks) | Passed |
| D673 | Heat Aging – 70 hours at 212°F | – Change in Hardness (points) | ± 15 max. +8 |
| | | – Change in Tensile Strength (%) | ± 30 max. -4.7 |
| | | – Change in Elongation (%) | ± 50 max. -26 |
| D2137 | Low Temperature Brittleness— 3 mins. at -40°F | Non-brittle | Passed |
| D624 | Tear Resistance Die C (min.) per inch of width min. | 125 lbs. per inch of width | 130 lbs. |
| U.L. 94 | Flame Resistance | U.L. 94 H.B. | Passed |

INSTALLATION GUIDELINES

- 1 Cut Dektite at appropriate pipe diameter marking.
- 2 Slide Dektite flashing down over pipe.
- 3 Apply sealant on underside of flexible aluminum base.
- 4 Press Dektite base into contours of panel configuration.
- 5 Fasten Dektite to surface with Buildex Scots® self-drilling fasteners. Apply extra sealant around base if desired.

| RECOMMENDED FASTENER | PART NO. | DESCRIPTION | BOX QTY |
|----------------------|----------|-------------------------------|---------|
| | 1175153 | 1/4-14 x 1-1/8" Scots Tekes 1 | 2,500 |

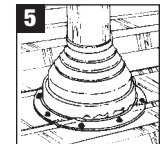
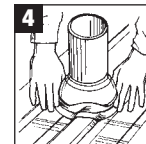
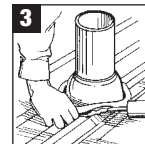
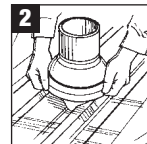
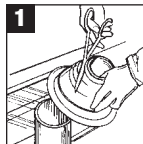

Notes:

- Dektite can be installed over or between the ribs of standard panels.
- DO NOT install over SSR or architectural panel seams.
- Generally no sealant is required where the Dektite collar provides a compression fit around the pipe. However, some metal pipes and flues include a seam which may require a local application of sealant at the point where the Dektite collar crosses the seam.

DEK-CAP™

STANDING SEAM ROOF END CAP FLASHING

The only universal end cap flashing!

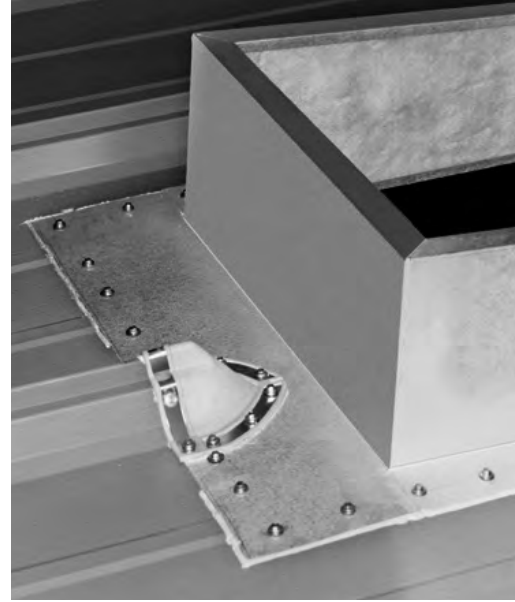

PRODUCT FEATURES

- Universal design allows use on left and right handed seams.
- Flexible, corrosion resistant aluminum base conforms to the majority of standing seam roof panels.
- Pre-formed panel profile shape is designed to reduce installation time.
- Fastening locations are clearly indicated for accurate installation.
- Dual underside ridges provide maximum sealing protection.
- Thermal elastomer material provides excellent resistance to ozone, ultra-violet light and extreme temperatures.
- Thermal elastomer has a continuous temperature of -40°F to +250°F.
- Expansion notch provides added installation flexibility.
- Interior panel stop ensures correct installation position.



SELECTOR GUIDE

| PART NO. | DESCRIPTION | BOX QTY | APPLICATIONS |
|----------|-------------|---------|--|
| 4146910 | Dek-Cap | 10 | Metal Curbs, Skylights, Ridge Applications, Jobsite Retrofit |

PERFORMANCE DATA

| ASTM METHOD | TEST DESCRIPTION | SPECIFICATION | TEST RESULTS | |
|-------------|---|----------------------------------|--------------|----|
| D412 | Tensile Strength (min. psi rating) | 1450 psi min. | 1500 psi | |
| D412 | Ultimate Elongation (%) | 350 min. | 450 | |
| D1171 | Resistance to Ozone– min. rating | 100 (no cracks) | Passed | |
| D673 | Heat Aging – 70 hours at 212°F | – Change in Hardness (points) | ± 15 max. | +3 |
| | | – Change in Tensile Strength (%) | ± 30 max. | +2 |
| | | – Change in Elongation (%) | ± 50 max. | -3 |
| D2137 | Low Temperature Brittleness– 3 mins. at -40°F | Non-brittle | Passed | |
| D624 | Tear Resistance Die C (min.) per inch of width min. | 125 lbs. per inch of width | Passed | |

INSTALLATION GUIDELINES

- 1 Blend top so that both sides are parallel to metal roof.
- 2 Press Dek-Cap edges into contours of panel configuration.
- 3 Remove and apply sealant on underside of flexible aluminum edging.
- 4 Slide Dek-Cap flashing over panel profile.
- 5 Follow indicated fastening pattern to attach Dek-Cap to surface with Buildex Scots® self-drilling fasteners.
- 6 Apply additional sealant around base if desired.

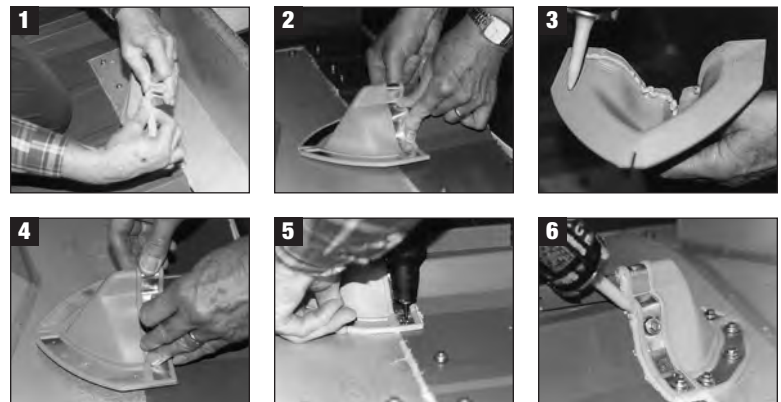

Recommended Sealant to use: Polyurethane Sealant

APPLICATIONS

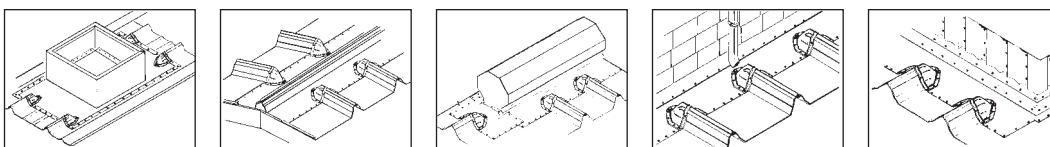

E-Z ANCOR®

SELF-DRILLING DRYWALL ANCHORS



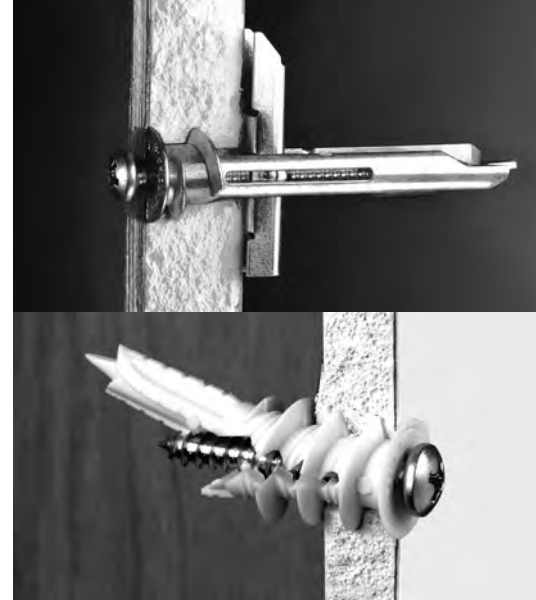

The Original, fast and easy self-drilling anchors. E-Z Zinc, E-Z Stud Solver, E-Z Mini, E-Z Lite, E-Z Plastic Plus, Twist-N-Lock, and E-Z Toggle

PRODUCT FEATURES

- No hole preparation necessary; pre-drills own small precise hole in gypsum wallboard.
- Replaces plastic plugs and toggles.
- Deep thread design provides strong engagement in 3/8", 1/2", and 5/8" gypsum wallboard.
- Installs quickly and easily with a phillips screwdriver or square drive bit.
- Full range of anchors to cover all wall fastening applications.
- Available in corrosion resistant, non-conductive white nylon.
- Can be easily backed-out.
- Low profile head.
- Single point designs for clean cutting installation.
- Stud Solver – attachments through gypsum and wood. Works in double drywall applications, too.

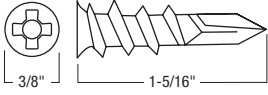

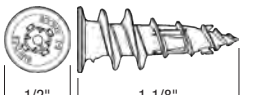
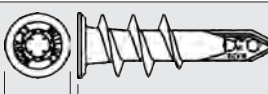
SELECTOR GUIDE

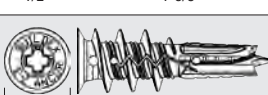
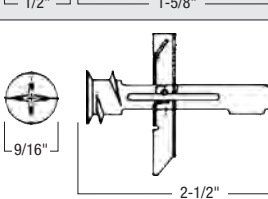
| | | ANCHOR DESCRIPTION | ANCHOR MATERIAL | PART NO. | QTY | MAXIMUM FIXTURE THICKNESS (IN.) | ACCOMODATES SHEET METAL SCREW SIZE |
|--------------|---|---|-----------------|----------------------|--|---------------------------------|------------------------------------|
| LIGHT DUTY | E-Z LITE |  | White Nylon | 5006902 | 10 – 100 ct boxes | 3/4" | #6 |
| | | | | 5006900 | Bulk – 10,000 anchors | | |
| | E-Z MINI |  | Zinc | 5033900 | Bulk only – 3,000 anchors | 3/4" | #6, #7 |
| MEDIUM DUTY | STUD SOLVER |  | Zinc | 5052900 | Bulk only – 1,500 anchors & screws | 3/4" | Use only with #8 screw provided |
| | E-Z ZINC |  | Zinc | 5000902 | 10 – 100 ct boxes | 3/4" | #6, #7 or #8 |
| | | | | 5000900 | Bulk – 1,500 anchors | | |
| | E-Z PLASTIC PLUS |  | White Nylon | 5035902 | 10 – 100 ct boxes | 3/4" | #6, #7 or #8 |
| 5035900 | | | | Bulk – 4,500 anchors | | | |
| TWIST-N-LOCK |  | White Nylon | 5061902 | 10 – 100 ct boxes | 3/4" | #8 | |
| | | | 5061900 | Bulk – 4,500 anchors | | | |
| HEAVY DUTY | E-Z TOGGLE |  | Zinc | 5014901 | 50 ct – 50 #8 x 2-1/8" Pan SMS | 1/2" | Use only with #8 screw provided |
| | | | | 5014900 | Bulk – 500 Anchors & Screws | | |
| | | | | 5017901 | 50 ct – 50 #8 x 2-1/8" Large Washer Face SMS | | |
| | | | | 5017900 | Bulk – 500 Anchors & Screws | | |

PERFORMANCE DATA

| ULTIMATE HOLDING WEIGHT | | | |
|-------------------------|-------------------|---------|----------|
| ANCHOR TYPE | DRYWALL THICKNESS | | |
| | 3/8" | 1/2" | 5/8" |
| Light Duty Plastic | 25 lbs. | 30 lbs. | 40 lbs. |
| Light Duty Zinc | 30 lbs. | 40 lbs. | 50 lbs. |
| Medium Duty | 40 lbs. | 50 lbs. | 75 lbs. |
| Twist-N-Lock | 65 lbs. | 75 lbs. | 80 lbs. |
| Heavy Duty | 70 lbs. | 85 lbs. | 150 lbs. |

These performance values are averages obtained under laboratory conditions. Note that these values will change depending on age, moisture content and surface treatment of the drywall (gypsum) material. Appropriate safety factors should be applied to these values for design purposes.

INSTALLATION GUIDELINES

LIGHT DUTY & MEDIUM DUTY E-Z ANCORS



1. Place #2 Phillips screwdriver into recess of E-Z Zinc, E-Z Lite, E-Z Mini, E-Z Stud Solver, Twist-N-Lock, or E-Z Plastic Plus.

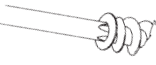

2. Press into drywall while turning the anchor clockwise until it is seated flush with wall.

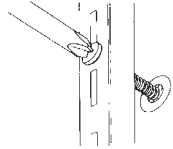

3. Place fixture in position over installed E-Z Zinc, E-Z Lite, E-Z Mini, E-Z Stud Solver, Twist-N-Lock, or Plastic Plus. Insert screw with screw driver. Tighten fixture in place.

*** Do Not Use For Mounting Televisions ***

HEAVY DUTY E-Z TOGGLE

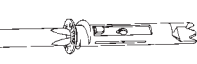

1. Using a #2 Phillips screwdriver, screw the E-Z Toggle Anchor into drywall until the head of the anchor is seated flush.

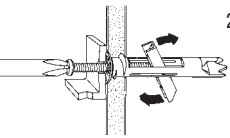

2. To "set" the clamp behind the drywall, place the mounting screw into the anchor and push or tap firmly until approximately 1" of screw is protruding (do not rotate). Then remove the screw.

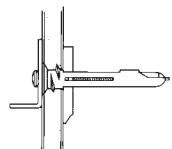

3. Place fixture over E-Z Toggle, insert screw and continue to turn until fastened tightly (for example when attaching a 1/2" thick fixture, it will require approximately 23 full rotations of the screwdriver to fully tighten the fixture).

*** Do Not Use For Mounting Televisions ***



ROCK-ON[®]

CEMENT BOARD FASTENERS

High performance rib design is still the best!

PRODUCT FEATURES

- Rib design under head countersinks into dense material while preventing stripouts.
- Two point types for steel and wood applications.
- Larger head diameter increases board surface contact for greater pullover resistance.
- Rock-On™ is recommended for ACQ treated wood.

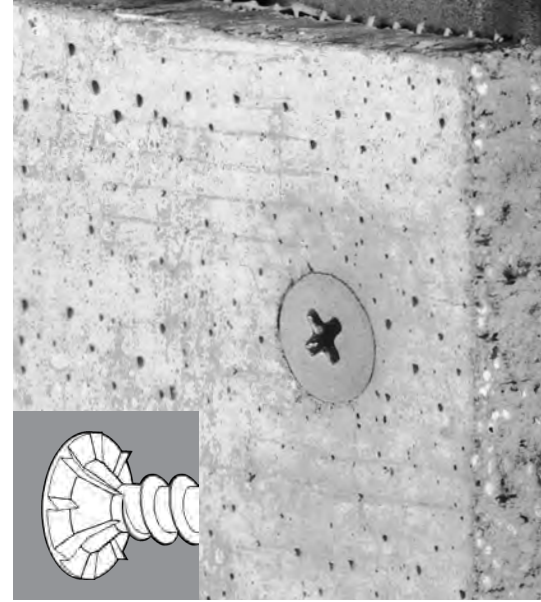

SELECTOR GUIDE

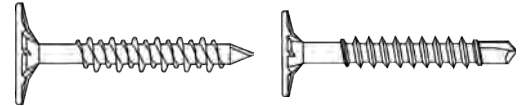

| PART NO. | LENGTH | MATERIAL ATTACHMENT RANGE | BOX QTY | APPLICATIONS |
|----------------------------------|------------|--|---------|---|
| HI-LO[®] ROCK-ON | | | | |
| 2153500 | 9 x 1-5/8" | Up to 1-1/8" Material Thickness to Wood 3/8" – 1-3/8" Material Thickness to Steel | 4,000 | Cement Board to wood or light gauge steel 26-20 gauge |
| S-12[®] ROCK-ON | | | | |
| 2156500 | 8 x 1-1/4" | 3/8" to 3/4" Material Thickness | 5,000 | Cement Board to Steel Studs 20-12 Gauge |
| 2159500 | 8 x 1-5/8" | 3/8" to 1-1/4" Material Thickness | 4,000 | |



INSTALLATION GUIDELINES

- A standard screwgun with a depth sensitive nosepiece should be used to install cement board fasteners. For optimal fastener performance, the screwgun should be a minimum of 6 amps and have an RPM range of 0-2500.
- Adjust the screwgun nosepiece to properly seat the fastener.
- Worn or damaged bit tips should be replaced.
- The fastener is fully seated when the head is flush with the work surface.
- Overdriving may result in torsional failure of the fastener or stripout of the substrate.
- The fastener must penetrate beyond the metal structure a minimum of 3 pitches of thread.

PERFORMANCE DATA

| PULLOUT VALUES IN STEEL (AVERAGE LBS. ULTIMATE) | | | | | | | | |
|---|-------------|-----|-----|-----|-----|-----|-----|------|
| GAUGE NO. | STEEL GAUGE | | | | | | | |
| | 26 | 24 | 22 | 20 | 18 | 16 | 14 | 12 |
| S-12 | 120 | 191 | 239 | 285 | 470 | 663 | 910 | 1424 |
| Hi-Lo | 163 | 242 | 314 | 370 | - | - | - | - |

| PULLOUT VALUES IN WOOD (AVERAGE LBS. ULTIMATE) | | | | |
|--|---------------------------|------|-----|--------|
| GAUGE NO. | EMBEDMENT IN #2 SPF 2 X 4 | | | |
| | 1/2" | 3/4" | 1" | 1-1/4" |
| Hi-Lo | 223 | 312 | 555 | 676 |

| SHEET STEEL GAUGES | | | | | | | | |
|--------------------|-------|-------|-------|-------|-------|-------|-------|-------|
| GAUGE NO. | 26 | 24 | 22 | 20 | 18 | 16 | 14 | 12 |
| DECIMAL EQUIVALENT | .018" | .024" | .030" | .036" | .048" | .060" | .075" | .105" |

The values listed are ultimate averages achieved under laboratory conditions and apply to Buildex manufactured fasteners only. Appropriate safety factors should be applied to these values for design purposes.

APPLICATIONS



Cement-type boards or any dense sheathings to steel or wood studs



Wire lath to steel or wood studs



Plywood to steel or wood studs

DEC-KING®

EXTERIOR WOOD SCREWS

Corrosion resistant fasteners for exterior wood applications



PRODUCT FEATURES

- Coated with Climacoat® for maximum resistance to corrosion, staining and streaking inside the lumber and on the deck.
- Recommended for ACQ treated wood.
- Pullout strength is superior over nails.
- Eliminates wood splitting, nail pops, hammer marks, and bent nails.
- Available in both #2 Phillips & #2 Square Drive.

SELECTOR GUIDE

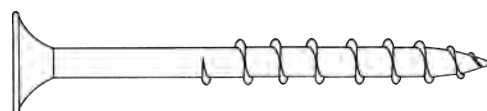

| PART NO. | DESCRIPTION | HEAD STYLE | BOX QTY | APPLICATIONS |
|----------|-------------|-----------------|---------|---|
| 2176500 | 6 x 1-1/4" | #2 Phillips | 8,000 | 1" x 4" or 1" x 6" Base Trim; Lattice |
| 2136500 | 6 x 1-5/8" | #2 Phillips | 5,000 | 1" x 4" or 1" x 6" Base Trim; Balusters; Lattice |
| 2138500 | 7 x 2" | #2 Phillips | 3,500 | 5/4" x 4" or 5/4" x 6" Radius Edged Decking; 1" x 4" or 1" x 6" Base Trim; Ballisters; Lattice |
| 2180500 | 8 x 2-1/2" | #2 Square Drive | 2,500 | 5/4" x 4" or 5/4" x 6" Radius Edged Decking; 2" x 4" or 2" x 6" Decking; 2" x 6" or 2" x 8" Rail Cap or Base Trim |
| 2140500 | 8 x 2-1/2" | #2 Phillips | 2,500 | |
| 2181500 | 8 x 3" | #2 Square Drive | 2,000 | 2" x 4" or 2" x 6" Decking; 2" x 6"; 2" x 8" Rail Cap or Base Trim |
| 2141500 | 8 x 3" | #2 Phillips | 2,000 | |
| 2142500 | 10 x 3-1/2" | #2 Phillips | 1,000 | |

PERFORMANCE DATA

| PULLOUT VALUES IN WOOD (AVERAGE LBS. ULTIMATE) | | | | |
|--|---|------|-----|--------|
| DESCRIPTION | EMBEDMENT IN 2 X 4 STUD GRADE S.Y. PINE | | | |
| | 1/2" | 3/4" | 1" | 1-1/4" |
| 6 x 1-1/4" | 182 | 329 | 422 | - |
| 6 x 1-5/8" | 182 | 329 | 422 | 620 |
| 7 x 2" | 189 | 318 | 440 | 630 |
| 8 x 2-1/2" | 186 | 290 | 502 | 630 |
| 8 x 3" | 186 | 290 | 502 | 645 |
| 10 x 3-1/2" | 241 | 386 | 522 | 721 |

The values listed are ultimate averages achieved under laboratory conditions and apply to Buildex manufactured fasteners only. Appropriate safety factors should be applied to these values for design purposes.

HEAD STYLES

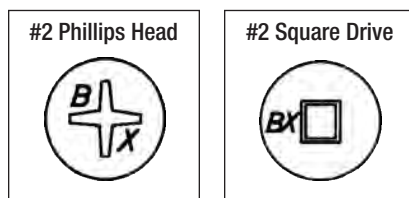

NOTES:



NATIONAL HEADQUARTERS

ITW Commercial Construction,
North America
155 Harlem Avenue
Glenview, IL 60025
Phone: 800-848-5611
Fax: 630-893-1270

TECHNICAL SUPPORT

Phone: 800-848-5611
Hours: 8:30 A.M. - 5:00 P.M. (CST, M-F)
Email: techsupport@itwccna.com

WILL CALL/DISTRIBUTION

2501 Galvin Dr
Elgin, IL 60123
Phone: 800-848-5611

CUSTOMER SERVICE

Phone: 800-848-5611
Hours: 7:30 A.M. - 5:00 P.M. (CST, M-F)
Email: orders@itwccna.com

www.itwbuildex.com