

**2022 - 23**  
**PRODUCT**  
**CATALOG**



**Ramset**<sup>®</sup>  
**DRIVING JOBSITE SPEED**



## Table of Contents

Powder Training & Certification .....	2
Buy American Act .....	3
LEED Credits .....	4
Intro To Gas Technology .....	5
Fasteners – How They Work .....	6
Suggested Specifications .....	8
Troubleshooting .....	9
Tool Selection Guide .....	10
Powder Fastener & Load Selection Chart .....	12
<b>Gas Fastening Systems</b>	
TrakFast .....	14
T4MAG .....	15
T4SS .....	16
GypFast / G2 .....	17
Ramset T4 I-F .....	18
<b>Powder Fastening Systems</b>	
RA27 .....	20
RA54 .....	21
Cobra .....	22
R25 .....	22
Viper4 .....	23
<b>Accessories</b>	
Pole Tools & Cups .....	24
Extension Poles .....	25
Tool Accessories .....	26
<b>Gas Tool Fasteners</b>	
TrakFast .....	28
T4MAG .....	29
GypFast / G2 .....	29
T4SS .....	30
<b>Powder Fasteners</b> .....	32
<b>Powder Loads</b> .....	36
<b>Performance/Submittal</b> .....	38



## ONLINE POWDER TRAINING AND CERTIFICATION

To protect the operator and assure safety on the jobsite, OSHA and ANSI require all powder actuated tool users to be trained and certified for the tool that will be used. Ramset enables you to receive training through our website training program. This approach combines interactive web-based training techniques and online testing with feedback during the test.

The course consists of approximately 30 pages of usage, safety, and troubleshooting material. Upon completion of this brief course, you will immediately take an online exam. With successful completion of the exam, you then print a Ramset certification card.

At the end of the course, you are also given the ability to download individual tool manuals.

### To take the course, and be certified to operate a Ramset powder actuated tool:

- Go to [www.Ramset.com](http://www.Ramset.com)
- Find the heading called *Get Your License*
- Click *P.A.T. Licensing*
- Click *Begin Operator Course* (choose English / Spanish / French)
- When course is complete, take the test
- After passing the test, download and print your certificate
- Place the certificate in your wallet

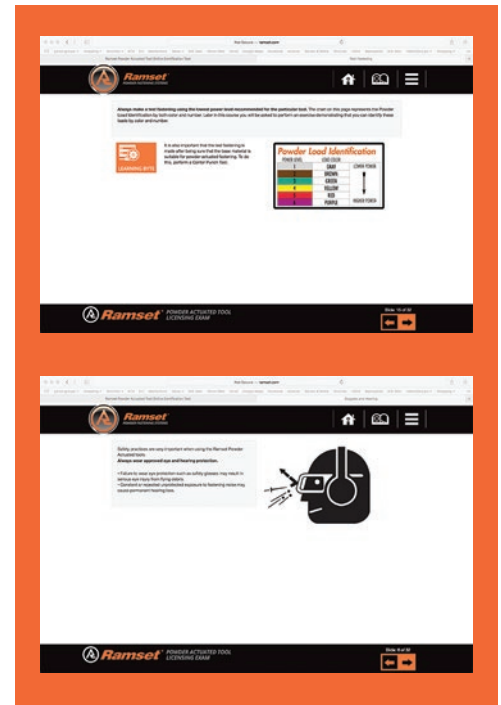

## RAMSET TOOL SERVICE CENTERS

- San Diego Tool Service Center
- Lake Forest Tool Service Center
- Atlanta Ramset Tool Service Center

**Northeast and South**  
 Ramset Tool Service  
 c/o Certified Tool Solutions  
 320 Northpoint Parkway SE  
 Suite Q  
 Acworth, GA 30102  
 Phone 770.218.6050  
[toolrepairs@gmail.com](mailto:toolrepairs@gmail.com)  
[www.ctstoolrepairs.com](http://www.ctstoolrepairs.com)

**West**  
 Ramset Tool Service  
 c/o South Coast Tool Repair  
 9660 Chesapeake Drive  
 San Diego, CA 92123  
 Phone 858.569.0929  
[mfoerster@socorepair.com](mailto:mfoerster@socorepair.com)

**Midwest**  
 Ramset Tool Service  
 13825 West Business Center Drive  
 Unit A  
 Lake Forest, IL 60045  
 Phone 800.222.6990  
[toolrepair@itwserviceparts.com](mailto:toolrepair@itwserviceparts.com)  
[www.ramsetrepair.com](http://www.ramsetrepair.com)

**Parts Only**  
 ITW Construction Parts  
[www.itwconstructionparts.com](http://www.itwconstructionparts.com)

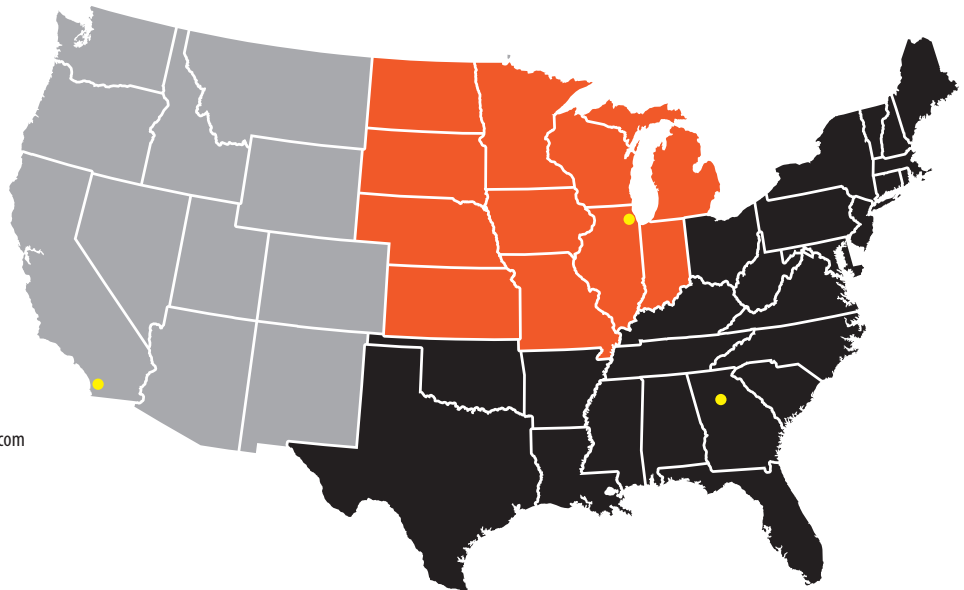

Ramset is unique in the world of construction tools and fasteners. Overall, 98% of Ramset fasteners and accessories are made in the USA.

Unlike our competitors you know you are buying American made products and supporting the American economy and workers when you buy Ramset. Ramset's parent company, Illinois Tool Works (NYSE: ITW) employees more than 25,000 Americans.

Manufacturer	Tools	Fasteners
<b>Ramset Tools</b>		
TrakFast	Libertyville, IL	Paris, KY
GypFast	Libertyville, IL	Paris, KY
<b>Ramset Manufacturing</b>		
Powder Loads Manufacturing		Oxford, MS
T3 & TF1200 Gas Fuel Cells		Pontotoc, MS



### The following is a sampling of projects that have utilized the Buy American Act using Ramset products:

- Rams / Chargers Stadium, Los Angeles CA
- Four Seasons, Boston MA
- Amazon Warehouse, San Antonio TX
- Midway Airport Expansion, Chicago IL
- Dolphins Stadium, Miami FL



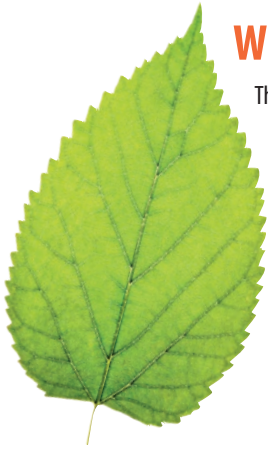

## What is LEED?

The purpose of Leadership in Energy and Environmental Design (LEED) is to construct buildings in an energy efficient manner and reduce the buildings' energy consumption. As a result, these buildings can help conserve non-renewable energy resources; decrease dependence on foreign oil; and lower greenhouse gas emissions.

### Ramset LEED Credit MR 5.1

MR 5.1 was developed with the intent to increase demand for building materials and products that are extracted and manufactured within the region, thereby supporting the use of indigenous resources and reducing the environmental impact resulting from transportation.

Ramset fasteners may meet the requirements for LEED MR 5.1 if your project falls within 500 miles of our manufacturing facilities.

### How to calculate LEED MR 5.1

LEED MR Credit 5.1 is calculated on a 500 mile radius from/to distribution points. Use Google Maps to calculate the distance to your project from:

Location	Zip Code	Product
Itasca, IL	60143	GypFast G2 & Fasteners
Paris, KY	40361	Powder & Gas Fasteners



## Ramset Recycles

Ramset has always recognized the value of utilizing recycled materials where available.

The raw material sourced for the manufacture of Ramset pins contains approximately 10-20% mill scrap when it is converted to wire material. The plastic and casing material in our loads typically consists of 10% recycled material.

Our packaging also contains post-consumer recycled material. The paper board (inner cartons) containers are typically made from 40% recycled material; corrugated cartons typically contain 30-35% recycled material.

## RECYCLING



ITW saw a challenge: how to create a portable tool that delivered the power of pneumatic tools without the hoses and compressors. In 1991, ITW Paslode conquered the challenge with the revolution of gas-powered technology. The cordless Impulse Finish Nailer delivered the power of pneumatic tools without cluttering job sites.

With the thought of Driving Jobsite Speed while creating a safer work environment, ITW Ramset built upon the Paslode technology and in 1992 introduced the TrakFast to the drywall trade. It forever changed the way the world worked. In 2003, ITW Ramset followed up on the success of

the TrakFast with the T3SS which is setting the standard for electrical and mechanical contractors. Then in 2021 Ramset raised the bar once again for gas fastening with the introduction of the T4 platform

Gas significantly lowers cost-in-place, reduces stress on the employee, and it's much quieter to use than drilling or powder actuated tools (PATs), so you can work in occupied buildings. There are times when you need the power and accuracy of our PATs—like the speed of our RA54 Magazine Tool. But constant use of these tools can be noisy and overly jarring on the body.



**Drywall**



**Electrical**



**Mechanical**

- No Licensing Required
- Fast and Easy to Use
- Quiet—No Recoil
- No Cords or Hoses
- Long Fuel Cell & Battery Life

## When the conditions are right, gas is the right choice.

**Problem:**  
*"My guys work on block all day long—from electrical boxes to furring. I've tried powder tools and they blow holes in block. What makes the Ramset technology different?"*

**Solution:**  
 Ramset technology has patented overdrive technology built in to every gas-powered tool. The tool works under the same principal as a combustion engine. A little gas, a little spark and a powerful shot, without the recoil associated with powder.

## The industry transitions to gas technology

**Problem:**  
*"I don't want to have to re-license my guys to work with gas technology"*

**Solution:**  
 Since there are no loads, there's no licensing needed. In fact, Union Trainers have begun including the Ramset Gas Tools in training classes, and students can't believe how easy the tools are to work with.

In addition, the gas powered tools are totally portable and can be used for almost all your jobs—without the worry of having unspent loads on your jobsite.

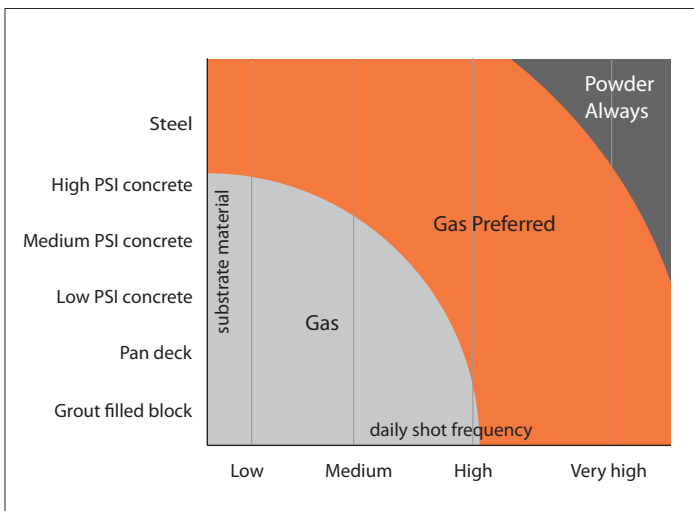

## The Inside Story

The patented Ramset technology delivers precisely balanced power eliminating the damage caused by overdrive in PATs.

How it works: As the nosepiece is depressed, a rechargeable battery turns on the fan motor. In less than a second: a precise amount of fuel is injected into the combustion chamber. When the trigger is pulled, a spark creates an explosion that drives the piston into the fastener, and the fastener in the work surface. The action creates a vacuum that pulls the piston back to the start position.

In fact the technology is so precise it won't blow through a pop can.

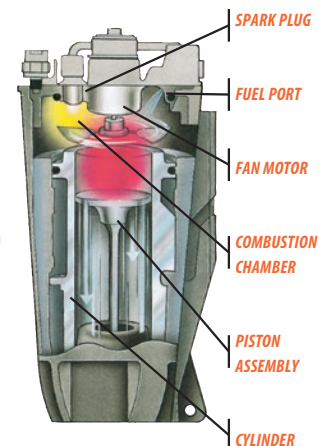

## SELECTING THE CORRECT FASTENER LENGTH

### SELECTING THE CORRECT FASTENER LENGTH

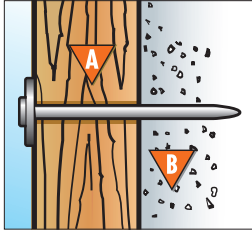

High quality fasteners provide consistent and reliable performance in concrete, block, masonry, and steel applications. Choosing the correct fastener for the job will assure professional results.

- A** Determine thickness of material being attached.
- B** Fastener must be long enough to drive approximately 1" into concrete, cement block or penetrate thickness of steel.

## POWER LEVEL GUIDE FOR LOADS

All loads are color coded and load level numbered. As the number increases, the power level increases.

*Always start with the lightest load.* If the fastener does not set completely, use the next higher load and repeat the process.

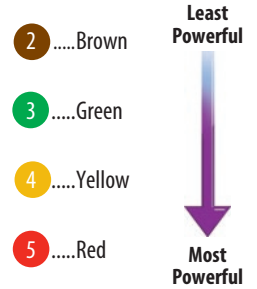

## TYPICAL USES

	WOOD ATTACHMENT MATERIAL*	CONCRETE BASE MATERIAL		STRUCTURAL STEEL BASE	
		Commonly Used Fastener	Commonly Used Load	Commonly Used Fastener	Commonly Used Load
	2 x 4	1516SDC (2-1/2")	Yellow #4	1514SD (2") SP178 (1-7/8")	Red #5 Red #5
	3/4" Plywood for furring strip	1512 (1-1/2")	Yellow #4	1510 (1-1/4")	Yellow #4
	1/4" - 1/2"	1510 (1-1/4")	Green #3	SP34 (3/4")	Yellow #4

\* Use Ramguard Pin for treated lumber.

	THIN GAGE STEEL	CONCRETE BASE MATERIAL		STRUCTURAL STEEL BASE	
		Commonly Used Fastener	Commonly Used Load	Commonly Used Fastener	Commonly Used Load
	Electrical Junction Boxes	M100BB (1")	Green #3	SP58TH (5/8")	Yellow #4
	Shelf Brackets	M100BB (1")	Green #3	SP34 (3/4")	Yellow #4
	Interior Drywall Track	1506/1506B (3/4")	Green #3	SP12 (1/2")	Yellow #4
	Perimeter Track	1510 (1-1/4")	Yellow #4	SP12 (1/2")	Yellow #4

**NOTE:** This chart is presented as a guide only. Start with the lightest load. If the fastener does not set completely, use the next higher load and repeat the process. Product suggestions may not be suitable for all types of base materials. Contact Technical Services if you have further questions.



## FASTENING TO CONCRETE AND STEEL

### FASTENING TO CONCRETE

As the fastener enters the concrete, extreme pressures and heat are created. This creates a bond that provides high loading strength in concrete snugly and provides tool protection.

### FASTENING TO STEEL

The resilience of steel provides a clamping effect to the fastener. This combined with the tremendous heat that is created, provides a welding and clamping effect to give maximum holding power.

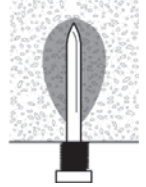

## EDGE / SPACING / BASE MATERIAL THICKNESS REQUIREMENTS

The following represents the minimum edge and spacing requirements, plus base material thickness requirements:

### CONCRETE

- 1. Edge distance.** Do not fasten closer than 3 inches from the edge of concrete. If the concrete cracks, the fastener may not hold and may allow the fastener to ricochet, causing serious injury or death to the operator or bystanders.
- 2. Recommended minimum fastener spacing.** Setting fasteners too close together can cause the concrete to crack. The recommended MINIMUM DISTANCE between fastening is three (3) inches. Never attempt a fastener application too close to another previously inserted fastener to prevent the second fastener from ricocheting off the previously installed fastener. A ricochet can result in serious injury or death to the operator or bystanders.
- 3. Concrete thickness.** It is important that the concrete be at least three (3) times as thick as the fastener penetration. If the concrete is too thin, the compressive forces forming at the fastener's point can cause the free face of the concrete to break away. This creates a dangerous condition from flying concrete and/or the fastener and also results in a reduction of fastener holding power.

### STEEL

- 1. Edge distance.** The recommended edge distance for a fastener to the edge of steel is 1/2 inch. Never fire the tool within 1/2 inch of the edge of a steel base material because the steel may bend or break off, allowing the fastener to ricochet, causing serious injury or death to the operator or bystanders.
- 2. Recommended minimum fastener spacing.** The recommended minimum distance between fastening is 1 inch. Never attempt a fastening application too close to another previously inserted fastener to prevent the second fastener from ricocheting off the previously installed fastener. A ricochet can result in serious injury or death to the operator or bystanders.
- 3. Steel thickness.** Do not fasten into steel base material thinner than the fastener shank diameter. Holding power will be reduced and the fastener may be over-driven, creating a dangerous situation to the operator or bystanders due to a free-flying fastener.

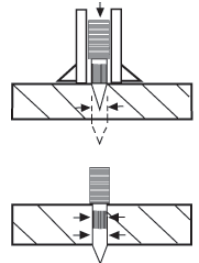

## HOW TO SELECT A POWDER ACTUATED FASTENER

- DRIVE PINS** are used to directly fasten an object (permanent installation).
- THREADED STUDS** are used where the object fastened is to be removed or where shimming is required. The following shows how to determine shank and thread length. Required penetration is determined by load requirement (illustrated in the following examples).

*Ramset fasteners may be specified by their type or catalog number to satisfy fastening requirements.*

### Permanent Installation

#### To Concrete

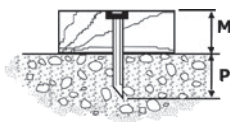

#### To Steel



Minimum Shank Length = Thickness of Material (M) + Thickness of Steel (T) + 1/4 Min. Point Allowance

### Removable Installation

#### To Concrete

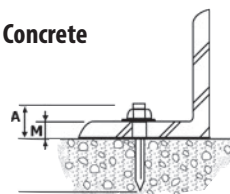

Thread Length (A) = Thickness of Material (M) + Allowance\* for Nut & Washer

Shank Length = 1"

\*Allowance for thickness of nut & washer = thread size (i.e. allow 1/4" for 1/4-20 thread, etc.)

#### To Steel

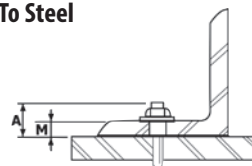

Thread Length (A) = Thickness of Material (M) + Allowance\* for Nut & Washer

Shank Length = 1/2"

Ramset provides the architect and engineer the following suggested language and helpful information for the purpose of fastening specifications.

**Plywood to Metal Framing or Truss**

**Part Number PLY138**

Fasteners used shall have a 0.100 nominal shank diameter with helical knurl and a length of 1-3/8".



**Track or Clip to Steel Beam**

**Part Number SP58TH**

Fasteners used shall have a 0.300 head with a 0.150 knurled shank diameter and a length of 5/8".

**Part Number TE12**

Fasteners used shall have a 0.320 head with a 0.157 knurled shank diameter and a length of .545".



**Exterior Sheathing to Metal Stud**

**Part Number GF112**

Fasteners designated "GYPFAST" and have a helical knurled shank with a 1-1/2".



**Interior Partition Track to Concrete**

**Part Number T3034B / T4034B**

Fasteners shall be designated T3 Type with a 0.125 nominal shank diameter and a length of 3/4".

**Part Number TE100**

Fasteners shall be designated "True Embedment" type with a 0.320 head with a 0.157 shank and length of 1.0625 providing minimum of 1" of embedment in up to 14ga track. Fastener shall have the embedment depth of 1" stamped on head.



**Exterior Perimeter Track to Concrete**

**Part Number 1510SD**

Fasteners used shall have a 0.145 nominal shank diameter and a length of 1-1/4". The fastener shall have a pre-assembled 7/8-inch washer.

**Part Number TE114**

Fasteners used shall be designated with a 0.157 dia. stepped shank to provide you with True Embedment depths of 1-1/4" in track up to 14 gauge.



**For assistance with specifications and/or substitutions, contact Technical Service at 800-848-5611.**

## CONCRETE SYMPTOM

### FASTENER DOES NOT HOLD IN BASE MATERIAL OR BASE MATERIAL SPALLS

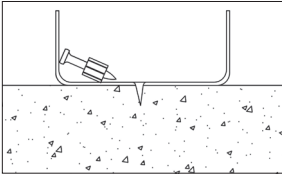

#### CAUSE

- High strength concrete
- Hard or large aggregate in concrete

#### ACTION

- Use shorter fastener
- Use PowerPoint pin
- Use load with a different power level

### FASTENER PENETRATES TOO DEEP

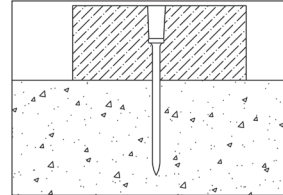

#### CAUSE

- Fastener too short for application
- Tool power level too high

#### ACTION

- Use longer fastener
- Use a lighter powder load

### FASTENER DOES NOT PENETRATE DEEP ENOUGH

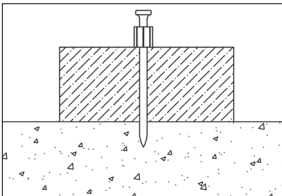

#### CAUSE

- Fastener too long
- Tool power level too low

#### ACTION

- Use shorter fastener
- Use a stronger powder load

### FASTENER BENDS

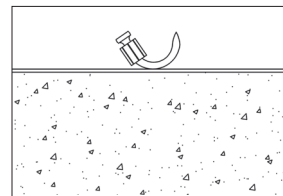

#### CAUSE

- Fastener hit large aggregate on entry
- Concrete too hard
- Fastener hit rebar just under the surface

#### ACTION

- Use shorter fastener
- Use PowerPoint pin
- Make sure tool is perpendicular to the work surface
- Move over 3 inches, try to fasten again

## STEEL SYMPTOM

### FASTENER DOES NOT PENETRATE THE SURFACE

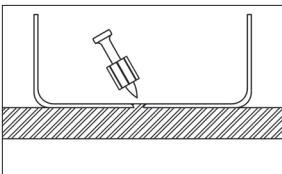

#### CAUSE

- Driving power too low
- Material may be too hard for forced entry fastener

#### ACTION

- Increase powder load level
- Use PowerPoint pin

### FASTENER DOES NOT HOLD IN BASE MATERIAL

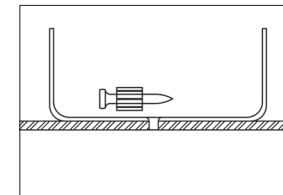

#### CAUSE

- Steel base material too thin

#### ACTION

- Use gas system tools with smaller shank pin or Teks Screw

### FASTENER BREAKS OR BENDS

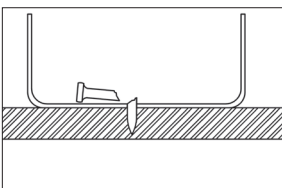

#### CAUSE

- Driving power is too low
- Fastener is too long
- Material may be too hard for forced entry fastener

#### ACTION

- Increase powder load level
- Reduce fastener length

### FASTENER DOES NOT FULLY PENETRATE STEEL

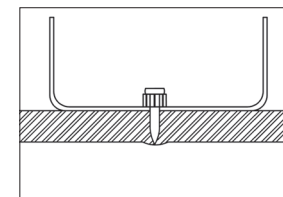





#### CAUSE

- Driving power too low
- Steel base material too thick
- Application limit may have been reached

#### ACTION

- Increase powder load level
- Use PowerPoint pin

GAS POWERED TOOLS	TOOL	DESCRIPTION	TYPICAL BUILDING TRADE*	
		<p><b>TRAKFAST TF1200</b></p> <ul style="list-style-type: none"> <li>• 42 Pin Magazine</li> <li>• Fully Automatic</li> <li>• 2 Year Warranty</li> </ul>	<ul style="list-style-type: none"> <li>• Length: 17.5"</li> <li>• Height: 15-1/2"</li> <li>• Weight: 7.9 lbs.</li> <li>• Maximum Pin Length: 1-1/2"</li> </ul>	<p><b>METAL FRAMING</b></p>
		<p><b>T4MAG</b></p> <ul style="list-style-type: none"> <li>• 45-Pin Magazine</li> <li>• One Step Fuel Injection &amp; Eject</li> <li>• Fully Automatic</li> <li>• 2 Year Warranty</li> </ul>	<ul style="list-style-type: none"> <li>• Length: 18-1/2"</li> <li>• Height: 15"</li> <li>• Weight: 8.55 lbs.</li> <li>• Maximum Pin Length: 1"</li> </ul>	<p><b>METAL FRAMING</b></p>
		<p><b>T4SS</b></p> <ul style="list-style-type: none"> <li>• Single Shot Gas Tool</li> <li>• One Step Fuel Injection &amp; Eject</li> <li>• 2 Year Warranty</li> </ul>	<ul style="list-style-type: none"> <li>• Length: 13-1/2"</li> <li>• Height: 15"</li> <li>• Weight: 7.6 lbs.</li> <li>• Maximum Pin Length: 1-1/2"</li> </ul>	<p><b>ELECTRICAL/MECHANICAL</b></p>
		<p><b>GYPFAST G2</b></p> <ul style="list-style-type: none"> <li>• 150 Pin Coil</li> <li>• Fully Automatic</li> <li>• 2 Year Warranty</li> </ul>	<ul style="list-style-type: none"> <li>• Length: 15"</li> <li>• Height: 15.25"</li> <li>• Weight: 7.6 lbs. (with battery)</li> <li>• Maximum Pin Length: 2-1/2"</li> </ul>	<p><b>EXTERIOR SHEATHING</b></p>
		<p><b>T4 I-F</b></p> <ul style="list-style-type: none"> <li>• Single Shot Gas Tool</li> <li>• One Step Fuel Injection &amp; Eject</li> <li>• 2 Year Warranty</li> </ul>	<ul style="list-style-type: none"> <li>• Length: 15"</li> <li>• Height: 15.25"</li> <li>• Weight: 7.6 lbs. (with battery)</li> <li>• Maximum Pin Length: 6"</li> </ul>	<p><b>INSULATION</b></p>

\*Building trade shown as suggestions. Tools are not limited to these trades.



	TOOL	DESCRIPTION	TYPICAL BUILDING TRADE*
.27 CAL STRIP TOOLS	 <p><b>RA27</b></p> <ul style="list-style-type: none"> <li>• Semi-Automatic</li> <li>• Power Adjust</li> <li>• 3 Year Warranty</li> </ul>	<ul style="list-style-type: none"> <li>• Length: 15-3/4"</li> <li>• Weight: 5.3 lbs.</li> <li>• Muzzle Bushing O.D.: 3/4"</li> <li>• Maximum Pin Length: 1-1/2" (2" w/Washer)</li> </ul>	<b>METAL FRAMING</b>
	 <p><b>RA54</b></p> <ul style="list-style-type: none"> <li>• Automatic Piston Return</li> <li>• Power Adjust Dial</li> <li>• 3 Year Warranty</li> </ul>	<ul style="list-style-type: none"> <li>• Length: 19"</li> <li>• Weight: 7.25 lbs.</li> <li>• Muzzle Bushing O.D.: 7/8"</li> <li>• Maximum Pin Length: 3"</li> </ul>	<b>METAL FRAMING</b>
	 <p><b>COBRA</b></p> <ul style="list-style-type: none"> <li>• Semi-Automatic</li> <li>• Economical</li> <li>• 1 Year Warranty</li> </ul>	<ul style="list-style-type: none"> <li>• Length: 13-1/4"</li> <li>• Weight: 5.0 lbs.</li> <li>• Muzzle Bushing O.D.: 9/16"</li> <li>• Maximum Pin Length: 2-1/2" (3" w/Washer)</li> </ul>	<b>WOOD FRAMING</b>
	 <p><b>VIPER4</b></p> <ul style="list-style-type: none"> <li>• Automatic Piston Return</li> <li>• Designed Specifically for Overhead Applications</li> <li>• 3 Year Warranty</li> </ul>	<ul style="list-style-type: none"> <li>• Length: 17"</li> <li>• Weight: 4.5 lbs.</li> <li>• Maximum Pin Length: 1-1/2"</li> </ul>	<b>ACOUSTICAL/OVERHEAD</b>
.25 CAL STRIP	 <p><b>R25</b></p> <ul style="list-style-type: none"> <li>• Semi-Automatic</li> <li>• 1 Year Warranty</li> </ul>	<ul style="list-style-type: none"> <li>• Length: 11.6"</li> <li>• Weight: 4.3 lbs.</li> <li>• Muzzle Bushing O.D.: 3/4"</li> <li>• Maximum Pin Length: 1-1/2"</li> </ul>	<b>WALLS &amp; CEILINGS</b>

\*Building trade shown as suggestions. Tools are not limited to these trades.

TO THIS BASE MATERIAL

	CONCRETE				STEEL BEAM - 3/16" to 1/2" THICK			
	FASTENER LENGTH (inches)	GAS TOOL	POWDER TOOL	POWDER LOAD	FASTENER LENGTH (inches)	GAS TOOL	POWDER TOOL	POWDER LOAD
INTERIOR NON-LOAD BEARING DRYWALL TRACK 25 - 20 GAGE	3/4	TF1200 T4MAG	R25	#3 GRN .25cal STRIP	1/2	TF1200 T4MAG	R25	#4 YEL .25cal STRIP
			SA270	#3 GRN .27cal STRIP			RA27	#4 YEL .27cal STRIP
EXTERIOR PERIMETER DRYWALL TRACK 18 - 12 GAGE	1-1/4	N.R.	RA27	#4 YEL .27cal STRIP	1/2	N.R.	RA27	#4 YEL .27cal STRIP
			RA54	#4 YEL .27cal STRIP			RA54	#4 YEL .27cal STRIP
			COBRA	#4 YEL .27cal STRIP			COBRA	#4 YEL .27cal STRIP
CLIPS or BRACKETS for STEEL FRAMING	1-1/4	N.R.	RA27	#4 YEL .27cal STRIP	1/2	N.R.	RA27	#4 YEL .27cal STRIP
			RA54	#4 YEL .27cal STRIP			RA54	#4 YEL .27cal STRIP
			COBRA	#4 YEL .27cal STRIP			COBRA	#4 YEL .27cal STRIP
2 x 4, 2 x 6 LUMBER	2-1/2	N.R.	RA27	N.R.	1-7/8	N.R.	RA27	N.R.
			RA54	#4 YEL .27cal STRIP			RA54	#4 YEL .27cal STRIP
			COBRA	#5 RED .27cal STRIP			COBRA	#5 RED .27cal STRIP
1/2" PLYWOOD	1-1/4	N.R.	RA27	#4 YEL .27cal STRIP	1	N.R.	RA27	#4 YEL .27cal STRIP
			COBRA	#4 YEL .27cal STRIP			COBRA	#4 YEL .27cal STRIP
			RA54	#4 YEL .27cal STRIP			RA54	#4 YEL .27cal STRIP
3/4" PLYWOOD 1 x 4, 1 x 6 WOOD	1-1/2	N.R.	RA27	#4 YEL .27cal STRIP	1-1/4	N.R.	RA27	#4 YEL .27cal STRIP
			COBRA	#4 YEL .27cal STRIP			COBRA	#4 YEL .27cal STRIP
			RA54	#4 YEL .27cal STRIP			RA54	#4 YEL .27cal STRIP
1/2" or 5/8" GYPSUM SHEATHING	-	N.R.	N.R.	N.R.	-	N.R.	N.R.	

FASTEN THIS MATERIAL

NOTES:

- 1) This chart is presented as a guide only. Start with the lightest load available. If the fastener does not completely set, use the next higher load and repeat the process.
- 2) Product suggestions may not be suitable for all types of base materials.
- 3) N.R. is Not Recommended

# POWDER FASTENER & LOAD SELECTION CHART

CONCRETE BLOCK				MORTAR JOINT (horizontal only)				LIGHT GAGE STEEL 18-12gauge			
FASTENER LENGTH (inches)	GAS TOOL	POWDER TOOL	POWDER LOAD	FASTENER LENGTH (inches)	GAS TOOL	POWDER TOOL	POWDER LOAD	FASTENER LENGTH (inches)	GAS TOOL	POWDER TOOL	POWDER LOAD
1	TF1200 T4MAG	R25	#3 GRN .25cal STRIP	1	TF1200 T4MAG	R25	#3 GRN .25cal STRIP	-	N.R.	N.R.	
		RA27	#3 GRN .25cal STRIP			COBRA	#3 GRN .27cal STRIP				
1	TF1200 T4MAG	RA27	#3 GRN .27cal STRIP	1	TF1200 T4MAG	RA27	#3 GRN .27cal STRIP	-	N.R.	N.R.	
		COBRA	#3 GRN .27cal STRIP			COBRA	#3 GRN .27cal STRIP				
		R25	#3 GRN .25cal STRIP			R25	#3 GRN .25cal STRIP				
1	TF1200 T4MAG	RA27	#3 GRN .27cal STRIP	1	TF1200 T4MAG	RA27	#3 GRN .27cal STRIP	-	N.R.	N.R.	
		RA54	#3 GRN .27cal STRIP			COBRA	#3 GRN .27cal STRIP				
			R25			#3 GRN .25cal STRIP	R25				
2-1/2	N.R.	RA27	N.R.	2-1/2	N.R.	RA27	N.R.	-	N.R.	N.R.	
		RA54	#3 GRN .27cal STRIP			RA54	#3 GRN .27cal STRIP				
		COBRA	#4 YEL .27cal STRIP			COBRA	#4 YEL .27cal STRIP				
1-1/2	TF1200	RA27	#3 GRN .27cal STRIP	1-1/2	TF1200	RA27	#3 GRN .27cal STRIP	1-1/2	TF1200 G2	N.R.	
		COBRA	#3 GRN .27cal STRIP			COBRA	#3 GRN .27cal STRIP				
2	N.R.	RA27	#3 GRN .27cal STRIP	2	N.R.	RA27	#3 GRN .27cal STRIP	1-1/2	TF1200 G2	N.R.	
		COBRA	#3 GRN .27cal STRIP			COBRA	#3 GRN .27cal STRIP				
		RA54	#3 GRN .27cal STRIP								
-	N.R.	N.R.		-	N.R.	N.R.		1-1/2	G2	N.R.	

## TRAKFAST TF1200



- **Part Number: TF1200**
- Gas Technology
- Fully Automatic
- 1-1/2" Pin Capacity
- 42 Pin Magazine Capacity
- Length: 17.5"
- Height: 15"
- Weight: 8.3 lbs.
- Maximum Capacity: 42 pins
- Maximum cycles/second: 2
- Fuel cell: 1000 shots
- Battery (charged): 3000 shots

### ADVANTAGES

- **SPEED:** Three to five times faster than powder tools. 42-pin magazine reduces load time.
- **EASY TO USE:** Tool automatically resets piston. No recoil, tool absorbs shock resulting in less operator fatigue.
- **NO LICENSING REQUIRED:** Unlike powder-actuated tools, no licensing is required.
- **NO CHANGING LOADS:** TrakFast uses a fuel cell, not a load. No need to inventory different colored loads
- **NARROW NOSE & PROFILE:** Allows tool to reach inside deep leg track (1-5/8" wide x 2" high).
- 2 Year Warranty (6 months on wearable parts).

### FEATURES

#### Still the most revolutionary fastening system in the construction industry!

Since its introduction in 1991, TrakFast has been the tool of choice for both interior and exterior contractors. The TrakFast Automatic Fastening System fastens all types of track, from standard track to hat channel, deep leg, Z, and J channel. Contractors continue to report tremendous savings when using TrakFast for high production fastening. They have learned that TrakFast's actual cost in place beats all other systems. The increased speed and productivity of TrakFast allows the contractor to bid more competitively, complete the job sooner and move on to the next job. Anyone can use TrakFast—just load the pins and fire. It's that easy!

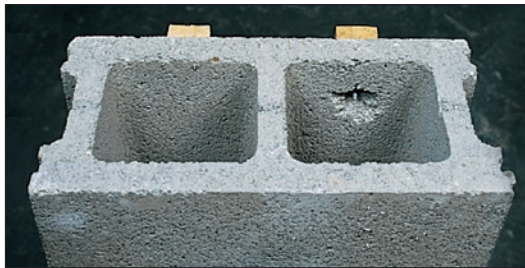

TrakFast ICC ESR-2579 is the only approval that allows you to fasten into any location on a hollow block wall and won't blow away block like a powder tool.

#### TrakFast's power comes from the battery and fuel cell

The 6-volt rechargeable Ni-CD battery can drive approximately 3000 shots per charge. The clean burning fuel cell can drive over 1000 pins and keeps the tool cleaner than powder actuated tools.

#### Fastening System Productivity

In the time it takes you to drive two pins with a powder tool, you can drive up to 10 pins with TrakFast!



### MOST COMMON FASTENERS

PIN #	PIN LENGTH		MOST COMMON APPLICATION
	IN.	(MM)	
FPP012S	1/2	12.7	Track to steel
FPP034B	3/4	19.1	Track to concrete



### APPLICATIONS



Track to steel



Lath attachment—using one-inch TrakFast discs and magnetic probe adapter



Furring attachment—perfect fastening every time in soft and hard base materials



Plywood attachment—using TrakFast plywood to steel pin



Track to concrete



## T4MAG



- **Part Number: T4MAG**
- Gas Technology
- 45-Pin Magazine
- One Step Fuel Injection
- Fully Automatic
- Length: 18-1/2"
- Height: 15"
- Weight: 8.55 lbs.
- Pin Guide O.D.: .590
- Maximum Pin Length: 1"

### ADVANTAGES

- Higher stick rate than industry standard.
- 30% more power to work in the toughest concrete.
- Drives pins flush to create full embedment.
- Lower pushdown force and shorter travel distance decrease user fatigue.
- Reduced jamming, resulting in less downtime on the job.
- Superb balance leads to optimal user experience.

### FEATURES

#### T4MAG Increase Your Range with Overhead Power

The Power of the T4MAG allows you to consistently shoot where no other gas tool has gone before. The .125 diameter pin is specifically engineered to work in the toughest concrete and steel where other pins cannot perform. The T4MAG system delivers power that rivals other gas and powder systems.

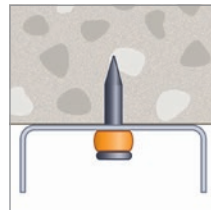

Settling aggregate is the biggest reason for overhead pin failure.

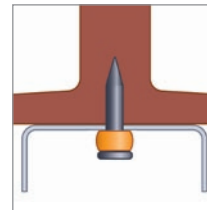

With the T4's 1/2" steel pin you can even shoot into the web of steel.

### ACCESSORIES

#### T4 Fuel Cell

##### Part No. T4FUEL

Replaces conventional powder loads and drives more than 1000 pins

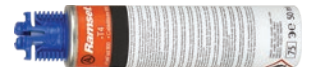

#### T4 Battery

##### Part No. 18581

The 6-volt Li-Ion battery can drive more than 3000 shots per charge



#### T4 Magnetic Nose Piece

##### Part No. 19967



MOST COMMON FASTENERS		ACCESSORIES	
PIN #	DESCRIPTION	ITEM #	DESCRIPTION
T4012	1/2" steel pin with T4 fuel cell	T4FUEL	T4 Fuel (4-pack x 3)
T4012S	1/2" premium steel pin with fuel cell	18581	T4 Battery
T4034B	3/4" concrete pin with T4 fuel cell	18582	Battery Charger
T4034S	3/4" step shank pin with T4 fuel cell	19967	T4MAG Magnetic Nose Piece
T4100	1" concrete pin with T4 fuel cell		



Easy battery loading. Battery rest position allows you to turn off the tool without fully removing the battery.



**VIDEO AVAILABLE**

### APPLICATIONS



The T4 has enough power to fasten into hard concrete and steel and still will not blow through hollow block.

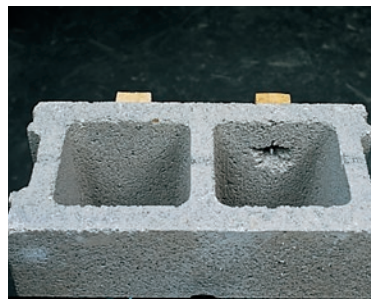

Will not spall hollow block like powder actuated.



Perfect for hat channel applications.

# T4SS



**VERSATILE**, fastens to solid concrete, hollow block, pan deck and steel.



- **Part Number: T4SS**
- Gas Technology
- Single Pin Gas Tool
- Fuel Injection
- Cross Over Technology
- 2 Year Warranty (6 months on wearable parts)
- Length: 13-1/2"
- Height: 15"
- Weight: 7.6 lbs.
- Pin Guide O.D.: 1/2" Standard, 7/8" Magnetic
- Maximum Pin Length: 1-1/2"

## ADVANTAGES

- Higher stick rate than industry standard
- 30% more power to work in hard concrete
- Drives pins flush to create full embedment
- Easy push-down force decreases user fatigue
- Preassembled fasteners for optimal job performance and easy ordering
- Superb balance leads to optimal user experience

## FEATURES

### CROSSING OVER FROM POWDER TO GAS

Ramset is serious when it comes to driving job speed by creating the T4SS—the single shot tool that will help move contractors from powder to gas.

The T4SS provides the benefits of shooting a gas tool, including reduced installation time and operator fatigue for the contractor who normally shoots a muzzle loaded powder tool.

To make the T4SS the most versatile gas tool in the industry, users can change out nosepieces to accommodate any fastening need. From metal-to-concrete, hard concrete or steel, pan deck, block and just about surface you can think of the T4SS works for you.



No more fines for unspent loads on the jobsite.

## APPLICATIONS

### FASTENER AND MAGNETIC NOSEPIECE



The optional interchangeable nosepiece (Part Number 19943) is able to shoot a variety of M series fasteners.

### T4CUP



### FUEL CELL AND BATTERY

#### T4 Fuel Cell / Part No. T4FUEL

Replaces conventional powder loads and drives more than 1000 pins



Fuel injection means no additional steps of preparing a fuel cell. Click the fuel cell in place and the tool is ready to go.

#### T4 Battery / Part No. 18581

The 6-volt Li-Ion battery can drive more than 3000 shots per charge



## MOST COMMON FASTENERS

PIN #	DESCRIPTION	INNER PACK QTY	CASE QTY
14TRHMP034	1/4" Rod Hanger with 3/4" plated pin (UL)	100	800
12HSMP034	1/2" Hole strap with 3/4" plated pin	100	800
34CCMP034L	3/4" Conduit clamp with 3/4" plated pin (UL)	25	150
TSHMP034	Tie strap holder with 3/4" plated pin (UL)	50	1250
M100	1" Plated pin with domed washer	100	5000
MP034TH	3/4" Plated pin with top hat	200	5000



12HSMP034 clip assembly used to secure conduit



M034 fastener used to hang HVAC Duct Strap



M100 fastener used to attach a junction box



Easy battery loading. Battery rest position allows you to turn off the tool without fully removing the battery.

**You Tube**  
**VIDEO AVAILABLE**

## GYPFAST G2



Fully Automatic Cordless Gas Fastening System for Attaching Exterior Sheathing to Light Gauge Steel Framing

- **Part No.:** G2
- Fully Automatic
- 2-1/2" Pin Capacity
- Length: 15"
- Height: 15.25"
- Weight: 7.6lbs. with battery
- Lengths: 1-1/2", 2" and 2-1/2"
- Pin Diameter: .140" Nominal
- Head Style: 5/16" dia. bugle head
- Finish: Long Life Coating

### ADVANTAGES

- Exterior Gypsum sheathing to steel framing
- Plywood and OSB sheathing/flooring
- Fiber cement panel attachment
- Blocking
- Exterior walls
- Windows/door bucks
- Specialty exterior sheathing attachment
- Woven wire mesh or expanded metal lath to steel framing

### FEATURES

- Fully automatic system with 150 nail capacity is 3-5 times faster than screwing.
- Fast set-up and tear down – insert battery, fuel cell and nail coil – eliminates need for extension cord, hoses and compressors.
- Aggressive, patented nail shank design provides high pullout performance.
- Contoured bugle head style provides high pullover (wind) resistance.
- Long life coating is 10 times more corrosion resistant than electro-zinc plating.
- Woven wire mesh or expanded metal lath to steel framing
- 2 year warranty

### MOST COMMON FASTENERS

PIN #	.140" DIA. KNURLED SHANK 5/16" DIA. BUGLE HEAD		MASTER CARTON	APPLICATION
	IN.	(MM)		
GF112	1-1/2	38.1	6,000 nails/ctn (40- 150 ct. coils) 6 fuel cells	Single Layer of Exterior Sheathing, Wood Furring and Blocking
GF212	2-1/2	63.5	2,700 nails/ctn (18 - 150 ct. coils) 3 fuel cells	Multi-Layers of Sheathing, Wood Blocking, and Dimensional Lumber

Fuel cell  
Part No. TFUEL



T3 Battery  
Part No. B0092



Plated 1" Lathing Disc  
Part No. LD100



### APPLICATIONS



Exterior Gypsum sheathing to steel framing, Plywood and OSB sheathing/flooring, Fiber cement panel attachment, Blocking Exterior walls, Windows/door bucks, Specialty exterior sheathing attachment, Woven wire mesh or expanded metal lath to steel framing.

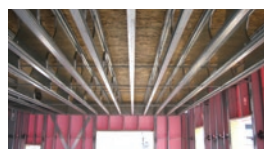

OSB and plywood to iSPAN joists



## RAMSET T4 I-F



The Ramset T4 IF System is 4 times faster than the traditional stick pin installation method. It allows the installer to attach insulation in one simple step without the use of adhesives or cutting spindle insulation anchors anymore

**White**  
for concrete and block

**Black**  
for steel and wood



### FUEL CELL AND BATTERY

#### T4 Fuel Cell / Part No. T4FUEL

Replaces conventional powder loads and drives more than 1000 pins



Fuel injection means no additional steps of preparing a fuel cell. Click the fuel cell in place and the tool is ready to go.

#### T4 Battery / Part No. 18581

The 6-volt Li-Ion battery can drive more than 3500 shots per charge



- **Part No.: T4 I-F**
- Single shot gas tool
- One step fuel injection & eject
- Length: 15"
- Height: 15.25"
- Weight: 7.6lbs. with battery
- 2 year warranty
- Operating Temperature: 5°F to 122°F

### ADVANTAGES

- Saves days over the traditional insulation fastening method saving time and labor costs.
- Safer than stick pins, powder actuated, and screw fastening methods.
- Fasten the insulation directly to concrete, hollow block, and steel studs. No need to glue and stick pin insulation anchors anymore.
- Tool allows you to fasten the insulation in tight spaces through pipes and sprinkler systems.
- The system can be used year round: unlike stick pins you won't be restricted by cold temperatures or wet surfaces.
- The T4FUEL can shoot more than 1000 shots before it needs to be replaced.
- Lower operator fatigue.
- 1"-6" insulation capacity.

### APPLICATIONS

*Most common application is fastening insulation to concrete, hollow block, and steel studs*



Above acoustical ceilings



Behind cladding over wood stud walls



Foundations & basements

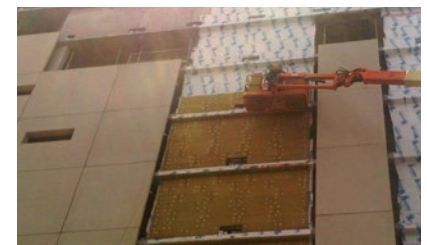

Behind cladding over concrete block walls



Interior walls on concrete block

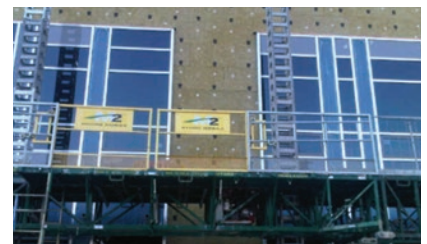

Behind cladding over steel stud walls



# Faster and Safer, Industry-Approved Thermal Break Fastener

## Performance Tables:

### CONCRETE

PART NUMBER SERIES	CONCRETE STRENGTH (PSI)	ALLOWABLE/ULTIMATE TENSION LOADS (Lbs)
IFC	<b>3600</b> - 6500	<b>35</b> - 211

\*Bold number is allowable load, second number is average ultimate load

### HOLLOW CONCRETE BLOCK

PART NUMBER SERIES	ALLOWABLE/ULTIMATE TENSION LOADS (Lbs)
IFC	<b>35</b> - 184

\*Bold number is allowable load, second number is average ultimate load

### STEEL STUDS

PART NUMBER SERIES	SHANK DIAMETER (INCH)	Installed in Cold Formed Steel Framing (lbf)					
		22 GAUGE	20 GAUGE	18 GAUGE	16 GAUGE	14 GAUGE	12 GAUGE
IFS (knurled)	0.100	<b>20</b> - 120	<b>33</b> - 200	<b>46</b> - 280	<b>60</b> - 360	<b>62</b> - 371	<b>75</b> - 448

\*Bold number is allowable load, second number is average ultimate load

### WOOD

PART NUMBER SERIES	SHANK DIAMETER (INCH)	Installed in 16/32" (1/2" nominal) 4 Ply Plywood Sheathing (lbf)
IFS (knurled)	0.100	<b>16</b> - 93

\*Bold number is allowable load, second number is average ultimate load

## Selection Chart:

INSULATION THICKNESS	CONCRETE OR BLOCK PART NO.	STEEL OR WOOD PART NO.	BOX QTY
1"	T4IFC-100	T4IFS-100	500
1-1/2"	T4IFC-112	T4IFS-112	500
2"	T4IFC-200	T4IFS-200	500
2-1/2"	T4IFC-212	T4IFS-212	500
3"	T4IFC-300	T4IFS-300	500
3-1/2"	T4IFC-312	T4IFS-312	500
4"	T4IFC-400	T4IFS-400	500
5"	T4IFC-500	T4IFS-500	500
6"	T4IFC-600	T4IFS-600	400
Tool	T4IF	T4IF	1



## Fastener Specifications:

- Pin Material: Heat treated carbon steel
- Pin Finish: Mechanical Zinc Plated
- Washer Material: High Density Polyethylene (HDPE)
- 2-3/8" Washer Diameter
- The fastener assembly is clearly branded Ramset along with the length of the fastener assembly

## Ramset I-F will attach:

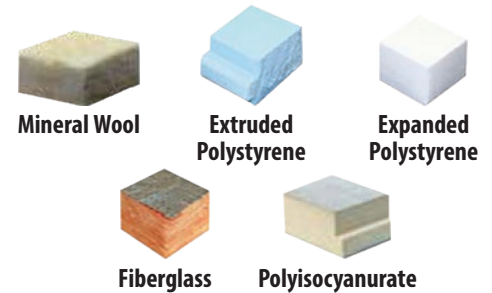

**Effective Fastener Length:** 3/4" for IFC- / 1-1/2" for IFS-

### Washer Diameter 2-3/8"

Large bearing surface keeps insulation from sagging



**Integrated Cap**  
Closed cap creates thermal break



**Washer Point**  
Designed to pierce dense insulation material

## Thermal Efficiency:

		INSULATION THICKNESS					
		1 in	2 in	3 in	4 in	5 in	6 in
Reference	U-Factor (W/m <sup>2</sup> °C)	1.1786	0.7122	0.5103	0.3976	0.3257	0.2758
	Efficiency (%)	100.00%	100.00%	100.00%	100.00%	100.00%	100.00%
Stick Pin	U-Factor (W/m <sup>2</sup> °C)	1.2442	0.7706	0.5597	0.4397	0.3621	0.3078
	Efficiency (%)	94.88%	92.42%	91.17%	90.43%	89.94%	89.9659
Ramset I-F	U-Factor (W/m <sup>2</sup> °C)	1.1845	0.7162	0.5132	0.3999	0.3276	0.2773
	Efficiency (%)	99.50%	99.45%	99.44%	99.43%	99.42%	99.42%

## RA27

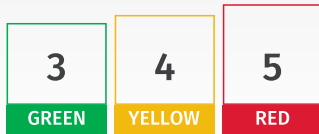
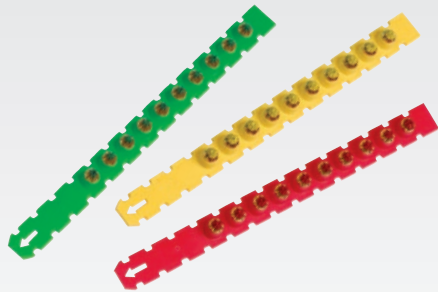

### POWDERLOAD IDENTIFICATION

Lower Power → Higher Power



#### Part No. RA27CUP

Works with 6' (V4-6) and 8' (V4-8) Poles



#### Part No. RA27MAG

Works with collated True Embedment (TE\_X) Pins



Ramset's fully automatic RA27 powder-actuated tool, lowering downtime and fatigue on commercial jobsites. The RA27 stands up to tough use for interior and exterior applications:

- Track-to-Concrete
- Track-to-Steel
- Exterior Cladding Clips
- Deep Leg Track
- Electrical/Unistrut
- Hat Channel

### RA27 TOOL SPECIFICATIONS

- **Part number:** RA27
- Weight: 5.3 lbs
- Maximum pin length without washer: 1½"
- Maximum pin length with washer: 2"
- 3-year warranty
- For use with .27 caliber loads (green, yellow, red)

### RA27MAG MAGAZINE SPECIFICATIONS

- **Part number:** RA27MAG
- Weight: 1.3 lbs
- Maximum pin length: 1¼"

### ADVANTAGES

- Lower pushdown force reduces fatigue
- Long-lasting piston reduces downtime
- Collar requires only ¼ turn for quicker cleaning
- More power load-for-load provides flexibility in a wide range of applications
- Swing out scaffold hook keeps the tool within reach
- Power adjust dial enables user to dial down power for ideal pin embedment
- Patented RRC (Residue Release Channel) allows tool to work longer between cleanings.
- Back end padding absorbs recoil, lowering fatigue
- Durable magazine providing up to 30% longer lifespan
- Belt/tether clip for safety



### MOST COMMON FASTENERS – TRUE EMBEDMENT PINS

PART #	PIN LENGTH		EMBEDMENT LENGTH		MASTER CARTON QTY
	IN.	(MM)	IN.	(MM)	
TE12	9/16	(13.8)	1/2	(12.7)	5000
TE34	13/16	(20.6)	3/4	(19)	5000
TE100	1-1/16	(27)	1	(25.4)	5000
TE114	1-5/16	(33.3)	1-1/4	(31.6)	1000

Shank diameter = .157 Head diameter = .320

### COLLATED TRUE EMBEDMENT PINS

PART #	PIN LENGTH		EMBEDMENT LENGTH		MASTER CARTON QTY
	IN.	(MM)	IN.	(MM)	
TE12X	9/16	(13.8)	1/2	(12.7)	5000
TE34X	13/16	(20.6)	3/4	(19.1)	5000
TE100X	1-1/16	(27)	1	(25.4)	5000
TE114X	1-5/16	(33.3)	1-1/4	(31.8)	5000

Shank diameter = .157 Head diameter = .320

### COMMON REPLACEMENT PART – AVAILABLE AT ITW SERVICE AND PARTS

- 751321 Piston

### RA54

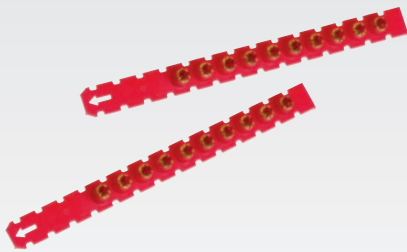

*Durable, Reliable, Powerful, Automatic*

# RA54

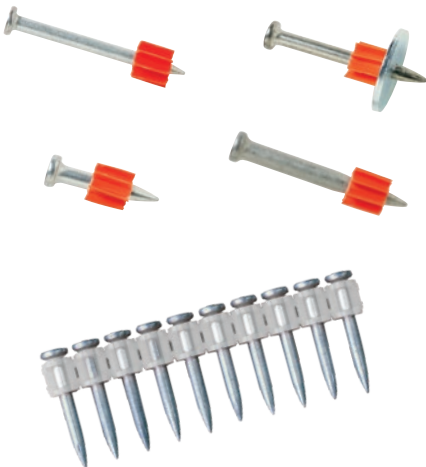

### Ramset's most powerful tool with increased speed, less downtime and improved reliability for maximized productivity

The Ramset RA54 was specifically designed for the commercial framer for heavy-duty interior & exterior applications. The RA54's combination of high power and durability make it perfect for these applications:

- Driving 1-1/4" embedment for perimeter track
- Fastening track & clips to structural steel
- Track to hard concrete
- Excellent compliment to your Ramset TrakFast program

#### FEATURES

- **Part Number: RA54**
- .27 Caliber Strip Tool
- Automatic Piston Return
- Power Adjust Dial
- 3" Pin Capacity
- 3 Year Warranty
- .27 Caliber Strip Loads: 3 (Green), 4 (Yellow), 5 (Red) 6 (Purple)
- Weight: 7.25 lbs.
- Length: 19"
- Muzzle Bushing O.D.: 7/8"

#### ADVANTAGES

- Improved trigger pull
- Requires less cleaning than typical tools – less downtime
- More power load-for-load than the prior XT540 model.
- Ideal for hard concrete applications (purple loads)
- Quick and intuitive to dis-/re-assemble for cleaning and piston replacement minimizing downtime
- Ergonomically balanced
- Works with Magnetic Muzzle (Part# 100227) & Lathing Discs

#### MOST COMMON FASTENERS

PIN #	SHANK LENGTH		MOST COMMON APPLICATION
	IN.	(MM)	
SP58TH	5/8	15.9	Track to steel
TE114	1-1/4	31.8	Track to concrete
SP114	1-1/4	31.8	Track to concrete

#### COMMON REPLACEMENT PART – AVAILABLE AT ITW SERVICE AND PARTS

- 37077 Piston
- 011483 Piston Return Spring



### RA54MAG

**Part No. RA54MAG**

Works with collated True Embedment (TE) Pins  
*Purple loads are not recommended for use with magazine*



## COBRA



- **Part Number: COBRA**
- .27 Caliber Strip Tool
- Semi-Automatic
- Economical
- .27 caliber 10-shot strip loads: 3 (Green), 4 (Yellow), 5 (Red)
- Weight: 5.0 lbs.
- Length: 13-1/4"
- Muzzle Bushing O.D.: 9/16"
- Maximum Pin Length: 2-1/2" (3" w/washer)

### ADVANTAGES

- Semi-automatic .27-caliber tool — uses strip loads
- Padded recoil-absorbing handle — for greater operator comfort
- Fastens up to 3" standard Ramset drive pins and threaded studs—ideal for general construction applications
- 1 Year Warranty

### MOST COMMON FASTENERS

PIN #	SHANK LENGTH		MOST COMMON APPLICATION
	IN.	(MM)	
1516SDC (washered)	2-1/2	63.5	2" x 4" to concrete
1524SDP(washered)	3	76.2	2" x 4" to concrete
SP58TH	5/8	15.9	Track to steel

### COMMON REPLACEMENT PART – AVAILABLE AT ITW SERVICE AND PARTS

- SC301200A Piston and Ring



VIDEO AVAILABLE

## R25



- .25 Caliber Strip Tool
- Semi-Automatic
- .25 Caliber Strip Loads: 3 (Green), 4 (Yellow), 5 (Red)
- Weight: 4.3 lbs.
- Length: 11.6"
- Maximum Pin Length: 1-1/2"
- 1 Year Warranty

### ADVANTAGES

- Rugged metal housing
- Rubber cushion grip
- Popular drywall track tool
- 1 Year Warranty

### MOST COMMON FASTENERS

PIN #	SHANK LENGTH		MOST COMMON APPLICATION
	IN.	(MM)	
1506B	3/4	19.0	Track to concrete
SP58TH	5/8	15.9	Track to steel

### COMMON REPLACEMENT PART – AVAILABLE AT ITW SERVICE AND PARTS

- SC325207A Piston Assembly



## VIPER4



- **Part Number: VIPER4**
- .27 Caliber Strip Tool
- Semi-Automatic
- Designed Specifically for Overhead Applications
- 3 Year Warranty
- .27 caliber 10-shot strip loads: 3 (Green), 4 (Yellow), 5 (Red)
- Weight: 4.9 lbs.
- Length: 17.25"
- Maximum Pin Length: 1-1/2"

### ADVANTAGES

- **Automatic load advance:** Load is advanced consistently each time the Viper is fired.
- **Automatic Piston return:** No time spent manually resetting or cycling the tool. Allows you to work faster.
- **Overdrive Protection:** Heavy duty buffer system prevents front end damage caused by piston overdrive —especially through sprayed-on insulation.
- **Open Front-end design:** Completely redesigned open-ended muzzle keeps your tool cleaner longer.
- **Simplified Barrel Retention Collar:** No tools are required for assembly or disassembly.
- **Stable Steel Collar:** The VIPER4 screws securely into the end of the extension pole with the steel collar ensuring a more durable and rigid connection.

### FASTENERS

- **ELECTRICAL PIN/CLIP ASSEMBLIES**  
Preassembled Pin & Clips for some of the most common electrical applications increase jobsite speed for the electrician.
- **STANDARD PIN/CLIP ASSEMBLIES**  
SDC Fasteners are designed with special dimples on the angle clips which act as a shim and assure a snug fit between the structural member and the clip.
- **POWERPOINT® PIN/CLIP ASSEMBLIES**  
SPC Fasteners are assembled with the patented technology of PowerPoint pins for penetration in hard concrete and steel. The uniform shape and finish of the engineered tip results in more consistent performance in your toughest situations.



**VIDEO AVAILABLE**



#### TOOL/POLE CONNECTION

The new poles have an internal rod, when activated by pushing on the pole sleeve triggers the new VIPER4.

PART NUMBER	DESCRIPTION
V4-6	6' Pole
V4-8	8' Pole
V4-EXT	3' Extension (no trigger)

\*Telescoping poles are NOT available for the VIPER4.

#### MOST COMMON FASTENERS

PIN #	SHANK LENGTH		MOST COMMON APPLICATION
	IN.	(MM)	
14TRHSS10	1	25.4	Threaded Rod Hanger
SDC125	1-1/4	31.8	Ceiling Clip
SPC114	1-1/4	31.8	Ceiling Clip

#### COMMON REPLACEMENT PART – AVAILABLE AT ITW SERVICE AND PARTS

- MVP140 Piston



The Viper4 screws solidly onto a pole for high reach and secure operation for ceiling applications.

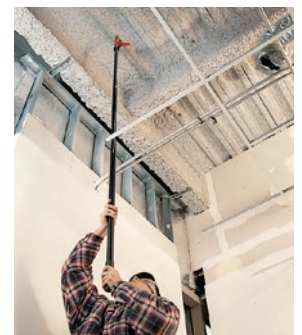

The Viper was engineered specifically for overhead applications.

## POLE TOOLS & CUPS

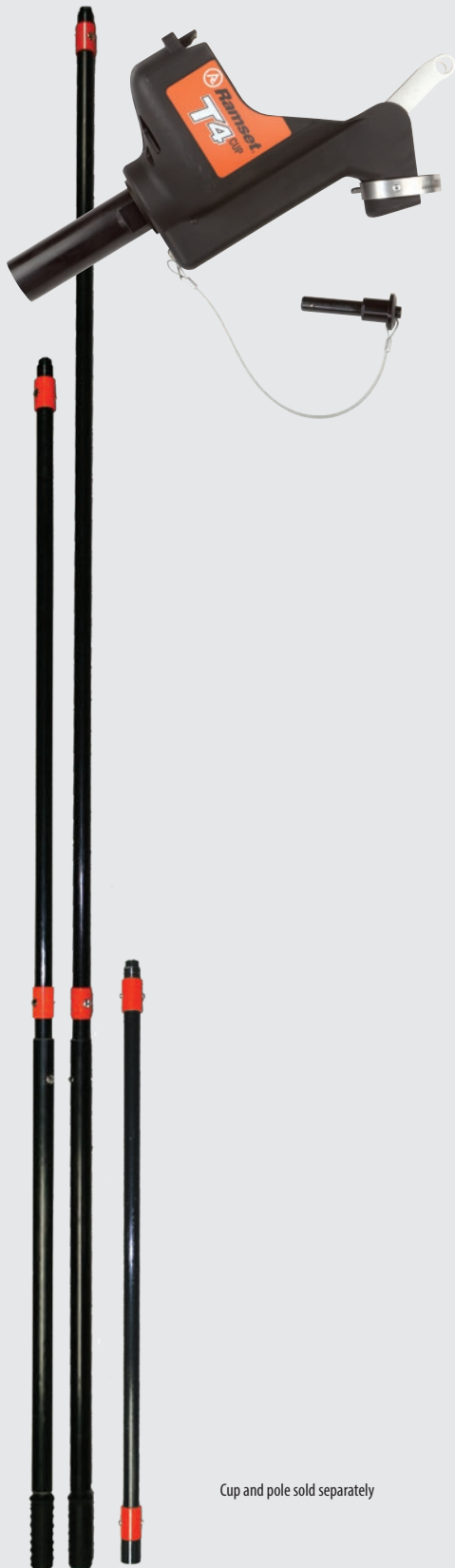

Cup and pole sold separately

### FEATURES

- Pole tools allow to easily fasten in overhead applications safety from the floor.
- Eliminate the need for ladders and scaffolding.
- Cup accessories designed to ergonomically balance the tools directly over the poles for a lightweight feel.

### EASY TO ASSEMBLE



### CUP ACCESSORIES AND POLES

PART #	DESCRIPTION	PART #	LENGTH
T3CUP	T3 Cup	V4-6	6' Pole
T4CUP	T4 Cup	V4-8	8' Pole
RA27CUP	RA27 Cup	V4-EXT	3' Extension (no trigger)



## EXTENSION POLES

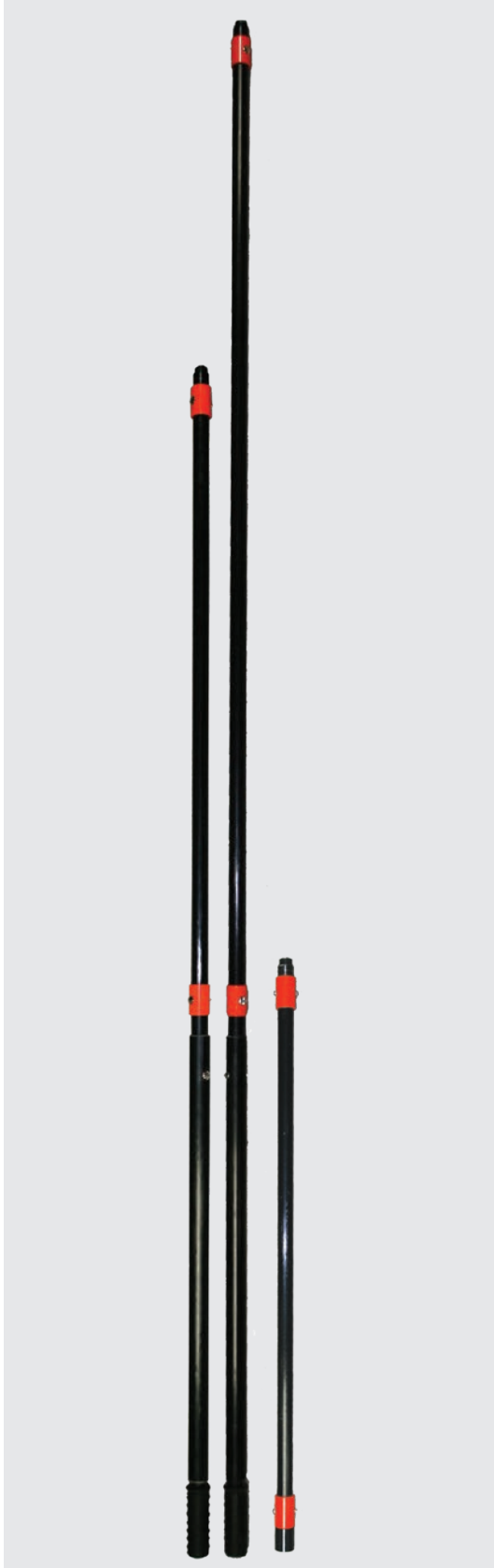

### ADVANTAGES

- Pole tools allow to easily fasten in overhead applications safely from the floor.
- Eliminate the need for ladders and scaffolding.
- Cup accessories designed to ergonomically balance the tools directly over the poles for a lightweight feel.

### POLES FOR RAMSET VIPER4

PART #	LENGTH
V4-6	6' Pole
V4-8	8' Pole
V4-EXT	3' Extension (no trigger)



Ramset Pole Tools are an excellent choice for high-reach fastening applications.

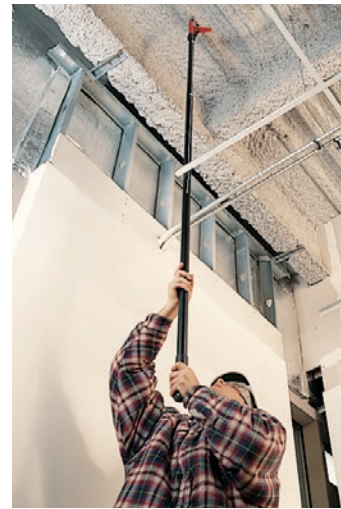

Fast, easy installation from floor level eliminates lift baskets, scaffolds and ladders.

### Uses VIPER4 pole system:

Works with three newly designed Ramset poles for greater ease and accuracy.



### TOOL/POLE CONNECTION

The pole has a unique internal rod that when activated by pushing on the pole sleeve triggers the VIPER4.



**ACCESSORIES**



**Part No. TFUEL**  
Fuel Cell for TrakFast (TF1100, TF1200) Gypfast, G2  
Qty: 12



**Part No. T4FUEL**  
Fuel Cell for T4SS & T4MAG, T4 I-F  
Qty: 12 (3-4 packs)



**Part No. T3FUEL**  
Fuel Cell for T3SS & T3MAG  
Qty: 12 (6-2 packs)



**Part No. 7505012**  
Battery for TF1100  
Qty: 1



**Part No. B0092**  
Battery for T3SS & T3MAG, TF1200, G2, T3IF-6  
Qty: 1



**Part No. 906014**  
Battery Charger Kit for TF1200, T3SS, T3MAG, T3IF-6, & G2  
Qty: 1



**Part No. 18581**  
Battery for T4SS, T4 I-F, T4MAG  
Qty: 1



**Part No. 18582**  
Battery Charger Kit for T4SS, T4 I-F, T4MAG  
Qty: 1



**Part No. LD100**  
Plated 1" Lathing Disc 22g  
Qty: 1,000 per box  
Works with all magnetic probes



**Part No. 19943**  
Magnetic Nose Piece for T4SS  
Qty: 1



**Part No. 19967**  
Magnetic Nose Piece for T4MAG  
Qty: 1

**ACCESSORIES – NOW AVAILABLE AT ITW CONSTRUCTION PARTS**



**Part No. 100041LA**  
Disc Holding Probe for TF1200 Probe  
Qty: 1



**Part No. M150200**  
Magnetic Nose Piece for T3SS  
Qty: 1



**Part No. 906001**  
Disc Holding Probe for T3MAG  
Qty: 1



**Part No. 100227\***  
Magnetic Muzzle for XT540  
Qty: 1

For other service parts, please contact Tool Repair and Parts at [www.itwconstructionparts.com](http://www.itwconstructionparts.com)



## Fastener Selection Table of Contents

Track to Concrete, Block & Steel (TF1200) .....	28
Plywood to Metal Studs (TF1200) .....	28
Track to Concrete, Block & Steel (T4MAG) .....	29
Exterior Sheathing to Metal Studs (G2) .....	29
Fasteners Designed for Use in T4SS .....	30
Fasteners Designed for Use in Powder Actuated Tools .....	32
Ceiling Clips / Angle Clips .....	34
Specialty Fasteners Designed for Powder Actuated Tools .....	35
Powder Actuated Loads .....	36



Ramset Collated Gas Tool Fasteners are specifically engineered for optimal performance in Ramset Gas Power Tools using fastener magazines.

## SELECTION CHART



### TRAKFAST STANDARD FUEL/PIN PACK

1000 PINS AND 1 FUEL CELL PER BOX

For high volume, repetitive fastenings to concrete and steel such as drywall track to concrete



PART NUMBER	PIN LENGTH		DESCRIPTION
	IN.	(MM)	
FPP012	1/2	(12.7)	1/2" Plated steel pin
FPP012S*	1/2	(12.7)	1/2" Premium Plated step shank pin
FPP034B	3/4	(19.1)	3/4" Black pin
FPP034S*	3/4	(19.1)	3/4" Premium Plated step shank pin
FPP100	1	(25.4)	1" Plated pin
FPP114	1-1/4	(31.8)	1-1/4" Plated Pin

Shank diameter = .109 \* Shank diameter = .104/.118 Head diameter = .250  
 Sold in master cartons of 5000 minimum. Cartons cannot be split.



### TRAKFAST BREAKAWAY STRIP FUEL/PIN PACK

1000 PINS AND 1 FUEL CELL PER BOX

Collation designed to breakaway on impact. For high volume, repetitive fastenings to concrete such as wood furring to concrete



PART NUMBER	PIN LENGTH		DESCRIPTION
	IN.	(MM)	
FPP034T	3/4	(19.1)	3/4" Plated pin
FPP100T	1	(25.4)	1" Plated pin
FPP114T	1-1/4	(31.8)	1-1/4" Plated Pin
FPP112T	1-1/2	(38.1)	1-1/2" Plated Pin

Shank diameter = .109 Head diameter = .250  
 Sold in master cartons of 5000 minimum. Cartons cannot be split.

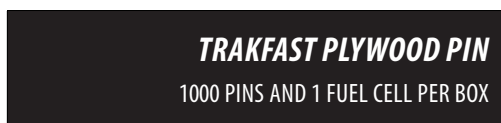

### TRAKFAST PLYWOOD PIN

1000 PINS AND 1 FUEL CELL PER BOX

For attaching plywood to metal studs



PART NUMBER	PIN LENGTH		DESCRIPTION
	IN.	(MM)	
PLY138	1-3/8	(34.9)	1-3/8" Plated pin (knurled)

Shank diameter = .109 Head diameter = .250 Helical knurled shank Mechanical zinc plated  
 Sold in master cartons of 5000 minimum. Cartons cannot be split.



## ADVANTAGES

### VS SCREWS

- 3 - 5 times faster than screw installation. No worrying about electrical cords.

### STRIP

- Collation strip breaks away upon impact, allowing the head of the pin to recess into the wood for a nice, clean look
- 10-pin strips transfer easily from the operator's pouch to the TrakFast tool, eliminating waste

### VS AIR SYSTEMS

- No set-up and tear down time. No hassling with compressors or hoses.

### PINS

- Hardened steel pin ensures a clean penetration of the fastener — no dimpling of the stud
- Knurled helical shank gives the fastener superior holding values
- Zinc plated for corrosion resistance

## SELECTION CHART



### T4MAG FUEL/PIN PACK

1000 PINS AND 1 FUEL CELL PER BOX

Larger .125 shank diameter offers improved success rate (15 pin strip)



PART NUMBER	PIN LENGTH		DESCRIPTION
	IN.	(MM)	
T4012	1/2	(12.7)	1/2" steel pin with T4 fuel cell
T4012S	1/2	(12.7)	1/2" premium steel pin with T4 fuel cell
T4034B	3/4	(19.1)	3/4" concrete pin with T4 fuel cell
T4034S*	3/4	(19.1)	3/4" step shank pin with T4 fuel cell
T4100	1	(25.4)	1" concrete pin with T4 fuel cell

Shank diameter = .125 \*Shank diameter = .104/.125 Head diameter = .250

Sold in master cartons of 5100 minimum. Cartons cannot be split.



### T3MAG FUEL/PIN PACK

1000 PINS AND 1 FUEL CELL PER BOX

Larger .125 shank diameter offers improved success rate (15 pin strip)



PART NUMBER	PIN LENGTH		DESCRIPTION
	IN.	(MM)	
T3012	1/2	(12.7)	1/2" steel pin with T3 fuel cell
T3012S	1/2	(12.7)	1/2" premium steel pin with T3 fuel cell
T3034B	3/4	(19.1)	3/4" concrete pin with T3 fuel cell
T3034S*	3/4	(19.1)	3/4" step shank pin with T3 fuel cell
T3100	1	(25.4)	1" concrete pin with T3 fuel cell

Shank diameter = .125 \*Shank diameter = .104/.125 Head diameter = .250

Sold in master cartons of 5000 minimum. Cartons cannot be split.



### GYPFAST / G2 FASTENERS

For attaching exterior sheathing, both gypsum and plywood, to metal studs

PART NO.	FASTENER DESCRIPTION .140" DIA. KNURLED SHANK 5/16" DIA. BUGLE HEAD	MASTER CARTON QUANTITY	MASTER CARTON WEIGHT	APPLICATIONS
GF112	1-1/2" (38mm)	6,000 nails/ctn (40- 150 ct. coils) 6 fuel cells	37 lbs.	Single Layer of Exterior Sheathing, Wood Furring and Blocking
GF212	2-1/2" (64mm)	2,700 nails/ctn (18 - 150 ct. coils) 3 fuel cells	26 lbs.	Multi-Layers of Sheathing, Wood Blocking, and Dimensional Lumber



#### LONG LIFE COATING ALLOWS FOR USE IN:

- Exterior applications
- Treated Lumber
- Treated Plywood
- Fire Resistant Plywood
- 20g to 14g applications

## T4SS SINGLE SHOT TOOL



The fasteners are designed for use in Ramset T3SS/T4SS single-shot gas tool

### SELECTION CHART

#### THREADED ROD HANGER

For suspended ceilings, piping and other items using 1/4" or 3/8" threaded rod. Fastener is pre-assembled to a 16 gage threaded rod hanger. 100 per jar.



PART NUMBER	DESCRIPTION	MASTER CARTON QUANTITY
14TRHMP034	1/4" Rod hanger with 3/4" plated pin	800
38TRHMP034	3/8" Rod hanger with 3/4" plated pin	800

Shank diameter = .104/.125 Head diameter = .300

#### ONE HOLE STRAP

Used to attach EMT conduit or armored cable to concrete. Fastener pre-assembled to a 16 gage conduit strap. 100 per jar, 3/8" 200 per jar.



PART NUMBER	DESCRIPTION	MASTER CARTON QUANTITY
38HSMP034*	3/8" Hole strap with 3/4" plated pin (UL)	1200
12HSMP034	1/2" Hole strap with 3/4" plated pin	800
34HSMP034	3/4" Hole strap with 3/4" plated pin	600
10HSMP034	1" Hole strap with 3/4" plated pin	600

Shank diameter = .104/.125 Head diameter = .300 \*38HSMP034 = 18 gage, 200 per jar

#### CONDUIT CLAMP

Used to attach conduit to concrete. Pin pre-assembled to an 18 gage conduit strap. 3/4" 25 per jar.



PART NUMBER	DESCRIPTION	MASTER CARTON QUANTITY
34CCMP034L	3/4" Conduit clamp with 3/4" plated pin	300

Shank diameter = .104/.125 Head diameter = .300

#### CEILING CLIP ASSEMBLY

Pre-assembled Ceiling Clip. Plated 14 gage clip. 100 per jar.



PART NUMBER	DESCRIPTION	MASTER CARTON QUANTITY
34CLIP	3/4" wide angle clip w/ 3/4" length pin	800

Shank diameter = .104/.125 Head diameter = .300 Hole diameter = 5/16"

### AVAILABLE IN CONVENIENT JARS!

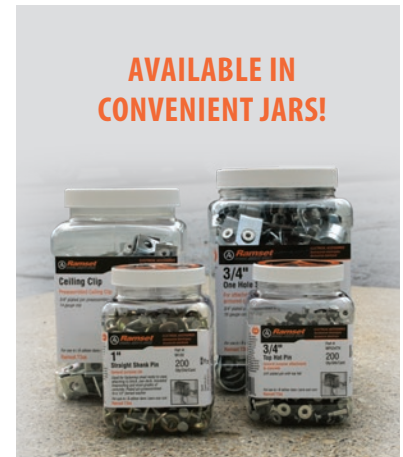

The new durable plastic containers mean less waste on the jobsite, or in the back of a truck. Their wide-mouth design makes it easy to grab what you need.



Each T3SS gas accessory and pin label provides vital holding value information—taking away the guess work.



## T4SS SINGLE SHOT TOOL



The fasteners are designed for use in Ramset T3SS/T4SS single-shot gas tool

### SELECTION CHART

#### TIE STRAP HOLDER

Used to install temporary lighting and secure low voltage cable to concrete, uses a standard cable tie up to 3/8" in width. Fastener is pre-assembled to a 22 gage tie strap holder. 50 per jar.



PART NUMBER	DESCRIPTION	MASTER CARTON QUANTITY
TSHMP034	Tie strap holder with 3/4" plated pin	1250

Shank diameter = .104/.125 Head diameter = .300

#### MECHANICAL PIN WITH WASHER

Used for the attachment of light gage metal to concrete and steel such as HVAC duct strap to concrete. Plated pin pre-assembled to a 1/2" domed washer. 200 per jar, 1" 100 per jar.

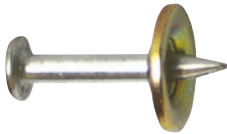

PART NUMBER	DESCRIPTION	MASTER CARTON QUANTITY
M034	3/4" Plated pin with domed washer	5000
M034BB	3/4" Premium step pin with domed washer	5000
M100	1" Plated pin with domed washer	5000

MUST USE WITH MAGNETIC WORK CONTACT ELEMENT (Part #19943 for T4SS / Part #M150200 for T3SS)

#### TOP HAT PIN

Used for general purpose fastening to concrete. Plated pin with top hat. 200 per jar.



PART NUMBER	DESCRIPTION	MASTER CARTON QUANTITY
MPO34TH	3/4" Plated pin with top hat	5000

Shank diameter = .125 Head diameter = .300

We maintain only the highest standards in the materials, production techniques and quality control measures used to manufacture our fasteners, assuring consistent, optimum quality in every fastener.

### FASTENER TERMINOLOGY SUFFIX

K = Knurled                      X = Collated                      C = 100 count  
 B = Black                        SD = Washer                      M = 1000 count  
 E = Ramguard                    TH = Top Hat

### ADVANTAGES

ITW Ramset powder actuated fasteners are specifically fabricated to meet the exacting requirements of toughness and durability that enable them to penetrate dense concrete and structural quality steel. All Ramset fasteners with .300 head will fit into tools with 8mm barrels.

### SELECTION CHART

<b>BLACK TRACK PINS</b>		SHANK LENGTH		R25 / RA27	SA270	XT540 / RA54	COBRA	MASTER CARTON QTY
	PART NUMBER	IN.	(MM)					
		1506B	3/4	(19.1)	.	.	.	.

Designed for use in concrete and structural steel applications. Available in 100-pack or 1000-pack per box.

Shank diameter = .145      Head diameter = .300

<b>PLATED PINS</b>		SHANK LENGTH		R25 / RA27	SA270	XT540 / RA54	COBRA	MASTER CARTON QTY
	PART NUMBER	IN.	(MM)					
		1503K	1/2 Knurled	(12.7)	.	.	.	.
	1506	3/4	(19.1)	.	.	.	.	5000
	1508	1	(25.4)	.	.	.	.	5000
	1510	1-1/4	(31.8)	.	.	.	.	1000
	1512	1-1/2	(38.1)	.	.	.	.	1000
	1514	2	(50.8)	.	.	.	.	800
	1516	2-1/2	(63.5)	.	.	.	.	800
	1524	3	(76.2)	.	.	.	.	600

Designed for use in concrete and structural steel applications. 100 per box.

Shank diameter = .145      Head diameter = .300

<b>WASHERED PINS</b>		SHANK LENGTH		R25 / RA27	SA270	XT540 / RA54	COBRA	MASTER CARTON QTY
	PART NUMBER	IN.	(MM)					
		1506SD	3/4	(19.1)	.	.	.	.
	1508SD	1	(25.4)	.	.	.	.	1000
	1510SD	1-1/4	(31.8)	.	.	.	.	1000
	1512SD	1-1/2	(38.1)	.	.	.	.	1000
	1514SD	2	(50.8)	.	.	.	.	1000
	1516SDC	2-1/2	(63.5)	.	.	.	.	600
	1524SDP*	3	(76.2)	.	.	.	.	600

Washer increases bearing surface against the material to be fastened. 100 per box. 16 gage metal washer. 7/8" diameter washer.

\*Square washer indicates 3" pin has been installed      Shank diameter = .145      Head diameter = .300

<b>RAMGUARD PINS</b>		SHANK LENGTH		R25 / RA27	SA270	XT540 / RA54	COBRA	MASTER CARTON QTY
	PART NUMBER	IN.	(MM)					
		1516E	2-1/2	(63.5)	.	.	.	.
	1516SDE	2-1/2	(63.5)	.	.	.	.	600
	1524SDE*	3	(76.2)	.	.	.	.	600

Coated to improve corrosion resistance in treated lumber and other applications. 100 per box. Recommended for treated lumber applications.

Shank diameter = .145      \*Square washer indicates 3" pin has been installed      \*1500 Series Coated with RamGuard      Head diameter = .300

## SELECTION CHART

### POWERPOINT PINS

Used for fastening into harder steel and concrete. Premium steel and hard concrete pin. 100 per box.



PART NUMBER	SHANK LENGTH		R25 / RA27	SA270	XT540 / RA54	COBRA	MASTER CARTON QTY
	IN.	(MM)					
SP12	1/2	(12.7)	•	•	•	•	5000
SP58	5/8	(15.9)	•	•	•	•	5000
SP34	3/4	(19.1)	•	•	•	•	5000

Shank diameter = .150 Head diameter = .300

### POWERPOINT STEP SHANK PINS

Used for fastening into harder steel and concrete. Premium steel and hard concrete pin. Pin for fastening into harder steel and concrete. 100 per box. (M100BB 500 per jar)



PART NUMBER	SHANK LENGTH		R25 / RA27	SA270	XT540 / RA54	COBRA	MASTER CARTON QTY
	IN.	(MM)					
M100BB	1	(25.4)	•	•	•	•	4000
SP114	1-1/4	(31.8)	•	•	•	•	1000
SP178	1-7/8	(47.6)	•	•	•	•	1000

Shank diameter = .150/.180 Head diameter = .300 M100BB shank diameter = .125/.150 with 1/2" washer

### POWERPOINT TOP HAT PIN

Used for general purpose fastening to steel. Plated pin with top hat. 100 per box.

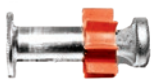

PART NUMBER	SHANK LENGTH		R25 / RA27	SA270	XT540 / RA54	COBRA	MASTER CARTON QTY
	IN.	(MM)					
SP58TH	5/8"	15.8	•	•	•	•	5000

Shank diameter = .150 Head diameter = .300

### TRUE EMBEDMENT PINS

The Ramset .157 True Embedment Pin is sized to provide you with True Embedment depths in track up to 14 gauge. Sized approximately 1/16" longer than nominal length to provide a True Embedment. 100 per box.



PART NUMBER	PIN LENGTH		EMBEDMENT LENGTH		R25 / RA27	VIPER	SA270	COBRA	XT540 / RA54	MASTER CARTON QTY
	IN.	(MM)	IN.	(MM)						
TE12	9/16	(13.8)	1/2	(12.7)	•	•	•	•	•	5000
TE34	13/16	(20.6)	3/4	(19.1)	•	•	•	•	•	5000
TE100	1-1/16	(27)	1	(25.4)	•	•	•	•	•	5000
TE114	1-5/16	(33.3)	1-1/4	(31.8)	•	•	•	•	•	1000

Shank diameter = .157 Head diameter = .320

### TRUE EMBEDMENT PINS

10-pin collated strips for the Ramset RA27 with RA27MAG and RA54 with RA54MAG.



PART NUMBER	PIN LENGTH		EMBEDMENT LENGTH		Master Carton Qty
	IN.	(MM)	IN.	(MM)	
TE12X	9/16	(13.8)	1/2	(12.7)	5000
TE34X	13/16	(20.6)	3/4	(19.1)	5000
TE100X	1-1/16	(27)	1	(25.4)	5000
TE114X	1-5/16	(33.3)	1-1/4	(31.8)	5000

Shank diameter = .157 Head diameter = .320

### XT540 COLLATED TRUE EMBEDMENT PINS

10-Pin Collated Stips for the XT540 with XT MAG only.



PART NUMBER	PIN LENGTH		EMBEDMENT LENGTH		MASTER CARTON QTY
	IN.	(MM)	IN.	(MM)	
TE12XT	9/16	(13.8)	1/2	(12.7)	5000
TE34XT	13/16	(20.6)	3/4	(19.1)	5000
TE100XT	1-1/16	(27)	1	(25.4)	5000
TE114XT	1-5/16	(33.3)	1-1/4	(31.8)	5000

Shank diameter = .157 Head diameter = .320 \*Cannot be used in other manufacturer's magazines



RA27MAG



XTMAG

## SELECTION CHART

### CEILING CLIP ASSEMBLIES

Designed for suspending ceilings and other overhead applications. Pin preassembled to a Zinc Plated 14 gage 45° clip. 1000 per box.

PART NUMBER	PIN LENGTH		VIPER	SA270 / RA27	COBRA	XT540 / RA54	MASTER CARTON QTY
	IN.	(MM)					
SDC100	1	(25.4)	•	•	•	•	1000
SDC125*	1-1/4	(31.8)	•	•	•	•	1000

\*Available in 100-Pack (P/N: SDC125C) Shank diameter = .145 Head diameter = .300 Hole Dia: .330"

### PREMIUM PINS WITH CEILING CLIPS

Designed for difficult overhead applications. Pin preassembled to a zinc plated 14 gage 90° angle clip. 1000 per box

PART NUMBER	PIN LENGTH		VIPER	SA270 / RA27	COBRA	XT540 / RA54	Master Carton Qty
	IN.	(MM)					
SPC78	7/8	(22.2)	•	•	•	•	1000
SPC114	1-1/4	(31.8)	•	•	•	•	1000

Shank diameter = .150 (SPC114 = .150/.180) Head diameter = .300 Hole diameter = 5/16"

### FASTENER ANGLE CLIP

General purpose 3/4" wide 90° angle clip. 14 gage angle clip. 100 zinc plated clips per box.

PART NUMBER	DESCRIPTION	MASTER CARTON QTY
1202CF	Angle clip (no pin)	1000

Hole diameter: 5/16" & 13/64"

### LATHER CLIP CHANNEL HANGER

PART NUMBER	DESCRIPTION	MASTER CARTON QTY
LC112	1-1/2" Lathers Clip Channel Hanger for 1/4" Plain Rod	100

## INSTALLATION

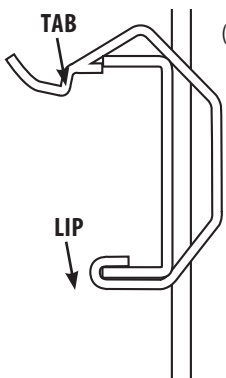

(Attached above clip)

1. Compress the clip and position on the rod at the desired location.
2. To install the channel, place the flange of the channel in the lip of the clip and rotate the channel toward the rod into position (see picture).
3. Use with cold rolled channel, with flange width 7/16" to 5/8" and hot rolled channel sizes 0.85#/ft and 0.105#/ft.
4. Static load limit, with a 3 to 1 safety factor, equals 160 lbs. Clip was tested to 480 lbs.
5. UL Tested

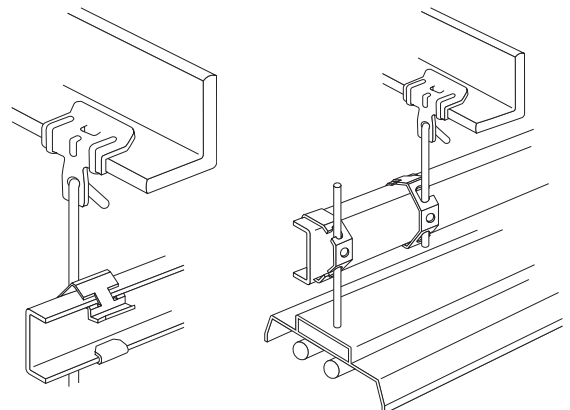





## SELECTION CHART

<b>HYBRID PIN</b>		For general purpose attachments to concrete. PowerPoint step shank pin pre-assembled to 1/2" washer. 500 per jar.			
		PART NUMBER	DESCRIPTION	ALL POWDER TOOLS	Master Carton Quantity
		M100BB	1" PowerPoint step shank pin with 1/2" domed washer & flute	•	4000

Shank diameter = .125/.150 Head diameter = .300

<b>ONE HOLE CONDUIT STRAP</b>		Used to attach EMT conduit or armored cable to concrete. PowerPoint fastener pre-assembled to a 16 gage conduit strap. 100 per box.			
		PART NUMBER	DESCRIPTION	ALL POWDER TOOLS	Master Carton Quantity
		38HSSS10*	3/8" Hole strap with w/1 premium pin	• (except SA270 and Cobra)	500
		34HSSS10	3/4" Hole strap with w/1 premium pin	•	500

Shank diameter = .125/.150 Head diameter = .300 38HSSS10 = 18 gage

<b>THREADED ROD HANGER</b>		For suspended ceilings, piping, and other items using 1/4" or 3/8" threaded rod. PowerPoint fastener pre-assembled to a 16 gage threaded rod hanger. 100 per box.			
 		PART NUMBER	DESCRIPTION	ALL POWDER TOOLS	Master Carton Quantity
		14TRHSS10	1/4" Rod hanger w/1" premium pin	•	500
		38TRHSS10	3/8" Rod hanger w/1" premium pin	•	500

Shank diameter = .125/.150 Head diameter = .300

## High Quality and Dependability

ITW Ramset powder loads and tools match tolerances to provide optimum power within recognized national velocity standards. Available in color-coded 10-load strips, and 100-load boxes.

**Caution** Always test-fasten with the lowest power level for your tool. If more power is necessary, use the next highest power level until proper level and fastening is achieved. Refer to operator's manual for more specific details. Observe all safety reminders. Tool operators must be trained and qualified as required by federal law. Failure to use properly can result in serious injury or death to users or bystanders.

### Advantages Powder Guide

Power level is designated by the load level number marked on each box; also by the color of the box and each powder load. As the number increases, the power level increases.

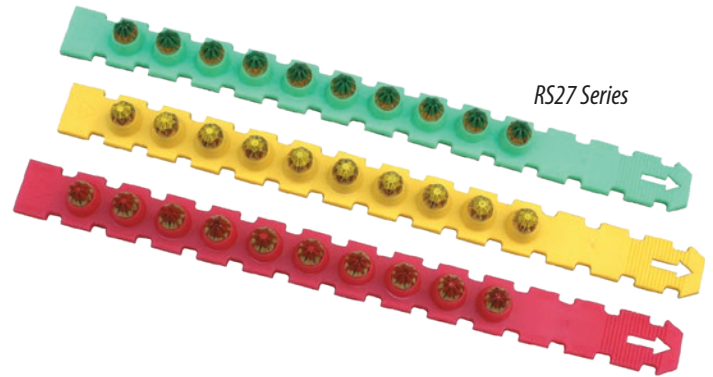
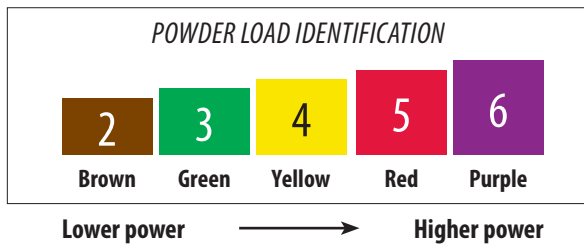

## SELECTION CHART

RAMSET LOADS FOR LOW VELOCITY TOOLS						COMPATIBLE TOOLS	
PART NUMBER	POWER LEVEL	COLOR	CALIBER/TYPE	PACKAGING	Master Carton Qty	RAMSET	OTHERS
						3RS25 4RS25 5RS25	3 4 5
3RS27 4RS27 5RS27 6RS27	3 4 5 6	Green Yellow Red Purple	.27 Strip .27 Strip .27 Strip .27 Strip	all 10 shot strip 10 strips/box all 10 shot strip 10 strips/box all 10 shot strip 10 strips/box all 10 shot strip 10 strips/box	10,000 10,000 10,000 10,000	SA270, Cobra, Viper, RA27, XT540 and RA54  RA54	DX2, DX350, DX351, DX36M, DX460, DX5  DX2, DX350, DX351, DX36M, DX451, DX460 DX451, DX460, DX5

## Performance Data/ Submittal Index

Collated Gas Fasteners in Concrete.....	38
Single Shot Gas and Powder Fasteners .....	39
Collated Gas Fasteners in Steel.....	39
Plywood Pin (PLY138).....	40
Gypfast Fasteners.....	42
Powder Actuated Fasteners (1500 Series).....	44
Powder Actuated Fasteners (SP Series).....	45
Powder Actuated Fasteners (TE Series).....	46
Ceiling Clips / Angle Clips.....	48



**Ramset fasteners may be specified by their type or catalog number to satisfy fastening requirements.**

**PIN SPECIFICATIONS**

- Made from AISI 1060-1065 steel. Austempered to a core hardness of 52-56 Rc
- Typical tensile strength: 270,000 psi
- Typical shear strength: 162,000 psi
- **STANDARD FINISHES**  
Proprietary black  
Mechanical zinc plate to a minimum thickness of .0002 meets requirements of ASTM B695—Class 5 Type I

**APPROVALS/LISTINGS**

- **ICC Evaluation Service, Inc.**  
#ESR-2579 TrakFast Pins      #ESR-1955 T3/T4 Fasteners
- **City of Los Angeles**  
#RR-25264 TrakFast pins      #RR-25739 T3/T4 pins

**Collated Gas Fasteners in Concrete (TrakFast and T3/T4)**

PART NUMBER SERIES	SHANK DIA (INCH)	MINIMUM PENETRATION (INCH)	INSTALLED IN SOLID CONCRETE CONCRETE COMPRESSIVE STRENGTH ALLOWABLE LOAD - <i>Ultimate Load</i>					
			2,000 PSI		3,000 PSI		4,000 PSI	
			TENSION (LBS)	SHEAR (LBS)	TENSION (LBS)	SHEAR (LBS)	TENSION (LBS)	SHEAR (LBS)
FPP - Straight Shank	0.109	5/8	<b>60</b> <i>434</i>	<b>55</b> <i>546</i>	<b>55</b> <i>453</i>	<b>75</b> <i>615</i>	<b>55</b> <i>472</i>	<b>95</b> <i>685</i>
		3/4	<b>60</b> <i>595</i>	<b>80</b> <i>650</i>	<b>55</b> <i>583</i>	<b>95</b> <i>699</i>	<b>55</b> <i>571</i>	<b>115</b> <i>749</i>
FPP - Step Shank	0.104/0.118	3/4	— —	— —	— —	— —	<b>51</b> <i>256</i>	<b>83</b> <i>418</i>

			2,000 PSI		4,000 PSI		6,000 PSI	
			TENSION (LBS)	SHEAR (LBS)	TENSION (LBS)	SHEAR (LBS)	TENSION (LBS)	SHEAR (LBS)
T3/T4 Straight Shank	0.125	5/8	<b>83</b> <i>414</i>	<b>109</b> <i>611</i>	<b>78</b> <i>426</i>	<b>80</b> <i>574</i>	<b>95</b> <i>545</i>	<b>128</b> <i>686</i>
		3/4	<b>107</b> <i>541</i>	<b>156</b> <i>855</i>	<b>104</b> <i>593</i>	<b>195</b> <i>977</i>	<b>132</b> <i>658</i>	<b>206</b> <i>1057</i>
T3/T4 Step Shank	0.104/0.125	5/8	— —	— —	<b>102</b> <i>525</i>	<b>138</b> <i>795</i>	<b>101</b> <i>511</i>	<b>119</b> <i>634</i>

PART NUMBER SERIES	SHANK DIA (INCH)	MINIMUM PENETRATION (INCH)	INSTALLED IN LIGHTWEIGHT CONCRETE / DECK / BLOCK ALLOWABLE LOAD - <i>Ultimate Load</i>					
			3,000 PSI LIGHT WEIGHT CONCRETE		3,000 PSI LIGHT WEIGHT CONCRETE WITH METAL DECK - LOWER FLUTE		HOLLOW CONCRETE MASONRY UNITS (CMU ANY LOCATION)	
			TENSION (LBS)	SHEAR (LBS)	TENSION (LBS)	SHEAR (LBS)	TENSION (LBS)	SHEAR (LBS)
FPP - Straight Shank	0.109	5/8	<b>35</b> <i>234</i>	<b>55</b> <i>403</i>	<b>30</b> <i>239</i>	<b>205</b> <i>1,025</i>	<b>35</b> <i>347</i>	<b>50</b> <i>435</i>
		3/4	<b>80</b> <i>630</i>	<b>100</b> <i>756</i>	<b>40</b> <i>330</i>	<b>235</b> <i>1,248</i>	— —	— —
FPP - Step Shank	0.104/0.118	3/4	— —	— —	— —	— —	<b>36</b> <i>184</i>	<b>58</b> <i>290</i>
T3/T4 Straight Shank	0.125	5/8	<b>84</b> <i>418</i>	<b>108</b> <i>540</i>	<b>72</b> <i>361</i>	<b>242</b> <i>1,210</i>	<b>20</b> <i>243</i>	<b>34</b> <i>264</i>
		3/4	<b>108</b> <i>540</i>	<b>173</b> <i>864</i>	<b>93</b> <i>470</i>	<b>288</b> <i>1,442</i>	— —	— —
T3/T4 Step Shank	0.104/0.125	5/8	<b>109</b> <i>543</i>	<b>181</b> <i>904</i>	<b>95</b> <i>473</i>	<b>219</b> <i>1,096</i>	<b>71</b> <i>357</i>	<b>123</b> <i>613</i>

**Note 1:** ALLOWABLE loads are shown in the **LARGE BOLD** font, *Ultimate* loads are shown in *smaller italic* font. **Note 2:** Testing conducted in accordance with ICC AC70 & ASTM E1190. **Note 3:** Safety factors are based on coefficient of variation. In accordance with ICC AC70, the safety factor will be no less than 5. **Note 4:** Values shown in concrete are for the fastener only. Connected members must be investigated separately. **Note 5:** Cyclic, fatigue, shock loads, and other design criteria may require a different safety factor. **Note 6:** Job site testing may be required to determine actual job site values. **Note 7:** Minimum edge distance in concrete is 3 inches unless otherwise approved. **Note 8:** For SI: 1 lbf = 4.448 N, 1 inch = 25.4 mm, 1 ksi = 6.89MPa. **Note 9:** T3/T4 straight shank allowable tension value in face shell of hollow CMU is 133 lbs.



**Fastener Assemblies in Concrete**

PART NUMBER SERIES	SHANK DIA. (INCH)	MINIMUM PENETRATION (INCH)	INSTALLED IN SOLID CONCRETE CONCRETE COMPRESSIVE STRENGTH ALLOWABLE LOAD - <i>Ultimate Load</i>						HOLLOW BLOCK Grade N, Type 1		
			4,000 PSI		6,000 PSI		3,000 PSI LIGHT WEIGHT LOWER FLUTE		FACE SHELL Min 1-1/4" face thickness		
			TENSION (LBS)	SHEAR (LBS)	TENSION (LBS)	SHEAR (LBS)	TENSION (LBS)	SHEAR (LBS)	TENSION (LBS)	SHEAR (LBS)	
GAS ASSEMBLIES	MP034TH*, M034* M100*, BR2*	5/8	<b>78</b> 426	<b>80</b> 574	<b>95</b> 545	<b>128</b> 686	<b>72</b> 361	<b>242</b> 1210	<b>133</b> 691	— —	
		3/4	<b>104</b> 593	<b>195</b> 977	<b>132</b> 658	<b>206</b> 1057	<b>93</b> 470	<b>288</b> 1442	<b>84</b> 444	<b>84</b> 446	
	M034BB	0.104/.118	5/8	<b>51</b> 256	<b>83</b> 418	— —	— —	— —	— —	<b>36</b> 184	<b>58</b> 290
	34 CLIP	0.104/.125	5/8	<b>62</b> 310	— —	<b>106</b> 528	— —	<b>44</b> 220	— —	— —	— —
	38HSMP034, 12HSMP034 34HSMP034, 10HSMP034 114HSMP034, 14TRHMP034 38TRHMP034, TSHMP034 12CCMP034L, 34CCMP034L	0.104/.125	5/8	<b>60</b> 357	<b>117</b> 587	<b>107</b> 533	<b>191</b> 957	<b>54</b> 269	<b>230</b> 1150	<b>71</b> 357	<b>123</b> 613
POWDER ASSEMBLIES	M100BB, 38HSS10 12HSS10, 34HSS10 10HSS10, 14TRHSS10, 38TRHSS10	0.125/.150	3/4	<b>107</b> 559	<b>213</b> 1067	<b>161</b> 803	<b>248</b> 1240	<b>96</b> 478	<b>231</b> 1156	<b>102</b> 512	<b>166</b> 831

\* ESR-1955 pin data applies. **Note 1:** ALLOWABLE loads are shown in the **LARGE BOLD** font, *Ultimate* loads are shown in *smaller italic* font. **Note 2:** Testing conducted in accordance with ICC AC70 & ASTM E1190 **Note 3:** Safety factors are based on coefficient of variation. In accordance with ICC AC70, the safety factor will be no less than 5. **Note 4:** Values shown in concrete are for fastener only. Connected members must be investigated separately. **Note 5:** Cyclic, fatigue, shock loads and other design criteria may require a different safety factor. **Note 6:** Job-site testing may be required to determine actual job site values. **Note 7:** Minimum edge distance is 3 inches unless otherwise approved. In hollow block applications, no more than one fastener per cell. **Note 8:** For Sl: 1 lbf = 4.448 N, 1 inch = 25.4 mm, 1 ksi = 6.89MPa. **Note 9:** 20 ga metal deck.

**Gas Fasteners in Steel**

PART NUMBER	SHANK DIA (INCH)	TYPE OF SHANK	INSTALLED IN A36 STRUCTURAL STEEL STEEL THICKNESS INCHES ALLOWABLE LOAD - <i>Ultimate Load</i>					
			3/16 (.1875)		1/4 (.250)		3/8 (.375)	
			TENSION (LBS)	SHEAR (LBS)	TENSION (LBS)	SHEAR (LBS)	TENSION (LBS)	SHEAR (LBS)
FPP012	0.109	SMOOTH	<b>195</b> 1047	<b>292</b> 1570	<b>223</b> 1220	<b>278</b> 1526	<b>181</b> 1048 <sup>7</sup>	<b>186</b> 1076 <sup>7</sup>
FPP012S	0.104/0.118	SMOOTH	— —	— —	<b>148</b> 744	<b>157</b> 787	<b>166</b> 832 <sup>7</sup>	<b>157</b> 787 <sup>7</sup>
T3012 /T4012	0.125	SMOOTH	<b>63</b> 676	<b>162</b> 1356	<b>239</b> 1285	<b>211</b> 1417	<b>113</b> 914 <sup>8</sup>	<b>197</b> 1327 <sup>8</sup>
T3012S /T4012S	0.125	TAPER SMOOTH	<b>183</b> 958	<b>332</b> 1660	<b>237</b> 1184	<b>356</b> 1782	<b>189</b> 943 <sup>10</sup>	<b>392</b> 1960 <sup>7</sup>
			INSTALLED IN ASTM A 572 GRADE 50 STEEL					
T3012 /T4012	0.125	SMOOTH	<b>103</b> 733	<b>222</b> 1682	<b>147</b> 950	<b>119</b> 973	<b>147</b> 856 <sup>9</sup>	<b>112</b> 1014 <sup>9</sup>

**Note 1:** ALLOWABLE loads are shown in the **LARGE BOLD** font, *Ultimate* loads are shown in *smaller italic* font. **Note 2:** Testing conducted in accordance with ICC AC70 & ASTM E1190. **Note 3:** Safety factors are based on coefficient of variation. In accordance with ICC AC70, the safety factor will be no less than 5. **Note 4:** Cyclic, fatigue, shock loads and other design criteria may require a different safety factor. **Note 5:** Job site testing may be required to determine actual job site values. **Note 6:** Values shown are for fastenings that have the entire pointed end of the fastener driven through the steel plate; except as noted below. **Note 7:** Fastener penetration is .31" minimum. **Note 8:** Fastener penetration is .29" minimum. **Note 9:** Fastener penetration is .27" minimum. **Note 10:** Fastener penetration is .25" minimum. **Note 11:** For Sl: 1 lbf = 4.448 N, 1 inch = 25.4 mm, 1 ksi = 6.89MPa

## PLY138 TrakFast Plywood to Steel Pin Performance Tables

### ALLOWABLE SHEAR FOR WIND OR SEISMIC FORCES IN POUNDS PER FOOT FOR HORIZONTAL PLYWOOD DIAPHRAGMS WITH STEEL FRAMING

PLYWOOD GRADE	MINIMUM STEEL GAUGE <sup>4, 6</sup>	MINIMUM PANEL THICKNESS (Inches)	BLOCKED DIAPHRAGM PIN SPACING (Inches) <sup>5, 6</sup> Pin spacing at diaphragm boundaries (all cases), at continuous panel edges parallel to load (cases 3 & 4) and at the panel edges (cases 5 & 6) ALLOWABLE LOAD				UNBLOCKED DIAPHRAGM PIN SPACING (Inches) <sup>5, 6</sup> Pins spaced 6 inches max. at supported edges	
			6	4	2-1/2	2	Case 1 (no unblocked edges or continuous joints parallel to load)	All other configurations (cases 2, 3, 4, 5 & 6)
			Pin spacing at other panel edges					
			6	6	4	3		
Structural 1	20	7/16	185	280	420	475	185	140
	16	15/32	205	305	460	520	205	150
Grades other than Structural 1	20	7/16	165	250	380	430	165	125
	16	15/32	185	275	415	470	185	140

**Note 1:** These values are for short-time loads due to wind or earthquake and shall be reduced by 25 percent for normal loading. **Note 2:** The pin shall be long enough to penetrate through the thickness of the steel a minimum of 1/4 inch. **Note 3:** Minimum width of framing is 1-1/2 inches. **Note 4:** These shear values also apply to framing made of thicker steel. **Note 5:** Spacing of fasteners along intermediate framing members is 12 inches on center. **Note 6:** The minimum panel edge distance is 3/8 inch. **Note 7:** Values shown reflect a 5:1 safety factor. **Note 8:** For SI: 1 lbf = 4.448 N, 1 inch = 25.4 mm, 1 ksi = 6.89MPa

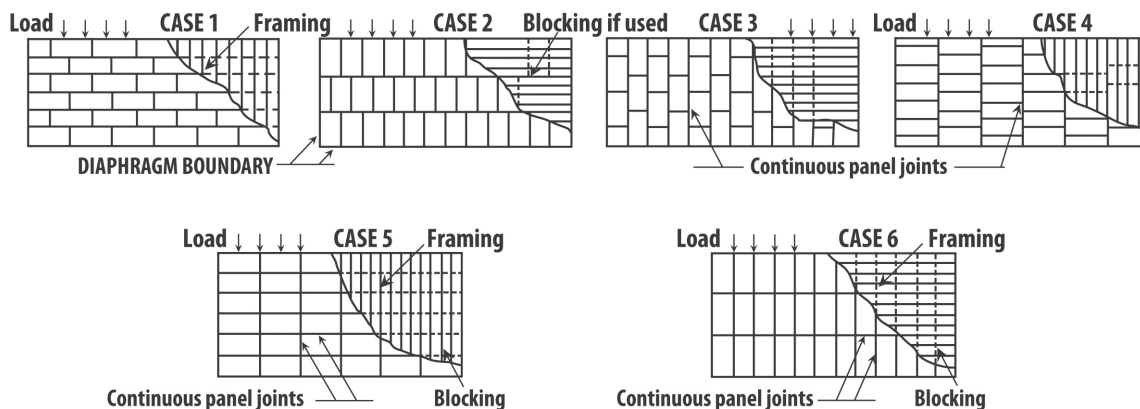

**Note:** Framing is permitted to be oriented in either direction for diaphragms, provided sheathing is designed for vertical loading.

### ALLOWABLE WITHDRAWAL LOADS IN POUNDS PER FASTENER DUE TO WIND OR SEISMIC FORCES FOR PLYWOOD AND LUMBER ATTACHED TO STEEL FRAMING<sup>1, 2, 3, 4</sup>

PIN DIAMETER (Inches)	MINIMUM STEEL THICKNESS (Gauge or Inches)	MINIMUM THICKNESS OF PLYWOOD (Inches) ALLOWABLE LOAD			
		3/8	7/16	15/32	19/32
0.100	22 / 0.030"	15	15	—	—
0.100	20 / 0.036"	20	25	25	25
0.100	18 / 0.048"	30	35	40	40
0.100	16 / 0.060"	40	45	60	60

**Note 1:** Plywood shall be Structural 1 rated. For other grades, values shall be reduced by 10 percent. **Note 2:** These values are for loads due to wind or earthquake and shall be reduced by 25 percent for other applications. **Note 3:** Minimum panel edge distance is 3/8 inch. **Note 4:** The pin shall be long enough to penetrate through the metal a minimum of 1/4 inch. **Note 5:** Values shown reflect a 8:1 safety factor. **Note 6:** For SI: 1 lbf = 4.448 N, 1 inch = 25.4 mm, 1 ksi = 6.89MPa

## PLY138 TrakFast Plywood to Steel Pin Performance Tables

### ALLOWABLE SHEAR FOR WIND FORCES IN POUNDS PER FOOT FOR PLYWOOD SHEAR WALLS WITH STEEL FRAMING

PLYWOOD GRADE	MINIMUM STEEL GAGE <sup>5</sup>	MINIMUM PANEL THICKNESS (Inches)	PIN SPACING, ALL PANEL EDGES (Inches) ALLOWABLE LOAD			
			6	4	3	2
Structural 1	22	3/8 <sup>6</sup>	120	180	240	305
	22	7/16 <sup>6</sup>	130	195	260	330
	22	15/32	145	215	290	365
	20	3/8 <sup>6</sup>	155	235	310	395
	20	7/16 <sup>6</sup>	170	255	340	435
	20	15/32	205	305	410	520
Grades other than Structural 1	22	3/8 <sup>6</sup>	110	165	215	275
	22	7/16 <sup>6</sup>	120	175	235	300
	22	15/32	130	195	260	330
	20	3/8 <sup>6</sup>	140	210	280	360
	20	7/16 <sup>6</sup>	155	230	310	390
	20	15/32	185	275	370	470

**Note 1:** Values are for loads imposed by wind and shall be reduced by 25 percent for normal loading. **Note 2:** The pin shall be long enough to penetrate through the metal framing a minimum of 1/4 inch. **Note 3:** The minimum panel edge distance for pin placement is 3/8 inch. **Note 4:** Spacing of fasteners along intermediate framing members is 6 inches on center for 3/8 inch and 7/16 inch panels when studs are 24 inches on center and 12 inches on center when studs are 16 inches on center. For other panel thickness, spacing along intermediate framing members is 12 inches from center. **Note 5:** Framing to be spaced 24 inches on center or closer except as provided in Footnote 6. **Note 6:** The values for 3/8-inch and 7/16-inch panels may be increased by 20 percent and 10 percent, respectively, for framing spaced 16 inches on center. **Note 7:** Values shown reflect a 5:1 safety factor. **Note 8:** For SI: 1 lbf = 4.448 N, 1 inch = 25.4 mm, 1 ksi = 6.89MPa

### ALLOWABLE LATERAL LOADS IN POUNDS PER FASTENER DUE TO WIND OR SEISMIC FORCES FOR STRUCTURAL<sup>1</sup> PLYWOOD AND LUMBER ATTACHED TO STEEL FRAMING <sup>1, 2, 3, 4, 6</sup>

PIN DIAMETER (INCHES)	MINIMUM PANEL THICKNESS (Inches)	MINIMUM THICKNESS OF PLYWOOD (Inches) ALLOWABLE LOAD					
		3/8	7/16	15/32	19/32	23/32	1-1/8
0.100	22	80	80	80	80	80	80
0.100	20	105	105	115	115	115	115
0.100	16	105	105	115	170	170	170

**Note 1:** Plywood shall be Structural 1 rated. For other grades, values shall be reduced by 10 percent. **Note 2:** These values are for loads due to wind or earthquake and shall be reduced by 25 percent for other applications. **Note 3:** Minimum panel edge distance for placement is 1 inch from the fastener to the sheathing edge measured in the direction of the load and 3/8 inch measured perpendicular to the direction of the load. **Note 4:** The pin shall be long enough to penetrate through the metal a minimum of 1/4 inch. **Note 5:** Values for 16 gage also apply to 14 gage. **Note 6:** The above values apply to groups of at least five fasteners. For fewer fasteners in a group, use one-half of the tabulated value. **Note 7:** Values shown reflect a 5:1 safety factor. **Note 8:** For SI: 1 lbf = 4.448 N, 1 inch = 25.4 mm, 1 ksi = 6.89MPa

**GypFast fasteners for the attachment of gypsum sheathing to light gage steel framing**
**PIN SPECIFICATIONS**

- Made from AISI 1060-1065 steel. Austempered to a core hardness of 52-56 Rc
- Typical tensile strength: 270,000 psi
- Typical shear strength: 162,000 psi
- **STANDARD FINISHES**  
Electro zinc nickel to a minimum thickness of .0002 meets the requirements of ASTM F1941

**APPROVALS/LISTINGS**

- **ICC Evaluation Service, Inc.**  
#ESR-2174 GypFast Gypsum Sheathing  
#ER-5380 GypFast Plywood Sheathing

**Allowable Negative Loads Using Ramset GypFast Fasteners**

SHEATHING TYPE	MINIMUM STEEL STUD GAGE	MAXIMUM STEEL STUD SPACING (IN)	FASTENER SPACING (IN)	ALLOWABLE NEGATIVE LOAD (PSF)
1/2" GP DensGlass Gold Exterior Sheathing	20g to 12g	24	8	6
		16	8	8
5/8" GP DensGlass Gold Fireguard Type X Sheathing	20g to 12g	24	8	24
		16	8	32
1/2" USG Sheetrock Brand Sheathing	20g to 12g	24	8	12
		16	8	16
5/8" USG Sheetrock Brand Fire Code Type X Sheathing	20g to 12g	24	8	18
		16	8	24
1/2" USG Fiberock Brand Aquatough	20g to 12g	24	8	30
		16	8	40
5/8" USG Securock Glass-Mat Sheathing	18g	16	8	35
5/8" CertainTeed GlasRoc Sheathing Type X	18g	24	8	20
5/8" CertainTeed GlasRoc Sheathing Type X	16g	24	8	18
National Gypsum e2XP Extended Exposure Sheathing	18g	16	8	39

**Note 1:** Tested in accordance with ASTM E330. **Note 2:** Values shown reflect a 3:1 safety factor. **Note 3:** The fasteners must be driven to a depth at which the shank pierces the steel, such that the tip protrudes from the base metal a minimum of 1/2-inch. **Note 4:** Tabulated values do not allow any overdriving of fasteners into sheathing.



## GypFast fasteners for the attachment of plywood sheathing to light gage steel framing

### PIN SPECIFICATIONS

- Made from AISI 1060-1065 steel. Austempered to a core hardness of 52-56 Rc
- Typical tensile strength: 270,000 psi
- Typical shear strength: 162,000 psi
- **STANDARD FINISHES**  
Electro zinc nickel to a minimum thickness of .0002 meets the requirements of ASTM F1941

### APPROVALS/LISTINGS

- **ICC Evaluation Service, Inc.**  
#ESR-2174 GypFast Gypsum Sheathing  
#ER-5380 GypFast Plywood Sheathing

## Allowable Withdrawal and Lateral Loads for a GypFast Fastener Used to Attach Structural Plywood Panels to Steel Framing Members<sup>1,2,3</sup>

MINIMUM STEEL THICKNESS (gauge) <sup>4</sup>	MINIMUM THICKNESS OF STRUCTURAL PANELS				MINIMUM THICKNESS OF STRUCTURAL PANELS			
	3/8 Inch	15/32 Inch	19/32 Inch	23/32 Inch	3/8 Inch	15/32 Inch	19/32 Inch	23/32 Inch
	WITHDRAWAL LOADS (POUNDS)				LATERAL LOADS (POUNDS)			
14	90	90	95	120	135	160	190	215
16	90	90	90	110	135	160	165	185
18	90	90	90	90	135	160	160	160
20	70	70	70	70	110	130	130	130
22	50	50	50	50	110	110	110	110

For SI: 1 Inch = 25.4 mm, 1 Pound = 4.448 N.

<sup>1</sup> Tabulated values are for loads due to wind or earthquake, and must be reduced by 25 percent for other applications.

<sup>2</sup> Tabulated values allow for no more than 20 percent of the fasteners to be overdriven more than 1/16 inch.

<sup>3</sup> Minimum edge distance and spacing are 3/8 inch and 3 inches, respectively.

## Allowable Shear for Wind Forces for Structural Plywood Shear Walls Attached to Light Gage Steel Studs with GypFast Fasteners<sup>1,2,3</sup> (pounds per foot)

PANEL TYPE	MINIMUM PANEL THICKNESS	FRAMING		FASTENER SPACING <sup>4,5</sup> (INCHES ON CENTER)			
		MINIMUM GAGE <sup>6</sup>	SPACING (INCHES ON CENTER)	6	4	3	2
Structural I or Rated Sheathing and Siding	3/8	22	16	180	270	360	459
	3/8		24	144	216	288	367
	15/32		16 or 24	170	255	340	433
	3/8	20	16	180	270	360	459
	3/8		24	144	216	288	367
	15/32		16 or 24	208	313	417	531
	3/8	18	16	214	321	428	546
	3/8		24	171	257	342	437
	15/32		16 or 24	253	380	506	645
	19/32		16 or 24	259	389	518	661
	23/32	16	16 or 24	259	389	518	661
	19/32		16 or 24	266	399	532	679
	23/32		16 or 24	296	445	593	756
	19/32	14	16 or 24	304	456	608	776
	23/32		16 or 24	345	517	690	879

For SI: 1 Inch = 25.4 mm, 1 Pound/Linear Foot = 0.0146 N/mm.

<sup>1</sup> These values are for short-term loads due to wind and must be reduced 25 percent for normal loading

<sup>2</sup> The pin must be long enough to penetrate through the metal framing a minimum of 1/4 inch

<sup>3</sup> Tabulated values allow for a maximum of 20 percent of the fasteners to be overdriven more than 1/16 inch

<sup>4</sup> All panel edges must be blocked with minimum nominal 2-inch framing. Panels are permitted to be installed either horizontally or vertically. Fasteners must be spaced a maximum of 6 inches on center along intermediate framing members for 3/8 inch-thick panels installed on framing spaced 24 inches on center, and 12 inches on center for framing 16 inches on center or thicker panels

<sup>5</sup> Tabulated values are for structural plywood panels applied to one side of a wall. Values cannot be increased for panels attached to both sides of a wall

Ramset fasteners may be specified by their type or catalog number to satisfy fastening requirements.

## PIN SPECIFICATIONS

- Made from AISI 1060-1065 steel. Austempered to a core hardness of 52-56 Rc
- Typical tensile strength: 270,000 psi
- Typical shear strength: 162,000 psi
- **STANDARD FINISHES**  
 Proprietary black  
 Electro zinc nickel to a minimum thickness of .0002  
 meets the requirements of ASTM F1941

## APPROVALS/LISTINGS

- **ICC Evaluation Service, Inc.**  
 #ESR-2690 Sill Plate  
 #ESR-1799 Powder Pins & Clips



## FASTENERS IN NORMAL WEIGHT CONCRETE

PART NUMBER SERIES	SHANK DIA (INCH)	MINIMUM PENETRATION (INCH)	INSTALLED IN SOLID CONCRETE CONCRETE COMPRESSIVE STRENGTH ALLOWABLE LOAD - <i>Ultimate Load</i>					
			2,000 PSI		4,000 PSI		6,000 PSI	
			TENSION (LBS)	SHEAR (LBS)	TENSION (LBS)	SHEAR (LBS)	TENSION (LBS)	SHEAR (LBS)
1500 SERIES	0.145	3/4	<b>50</b> <i>655</i>	<b>66</b> <i>739</i>	<b>100</b> <i>511</i>	<b>104</b> <i>552</i>	— —	— —
		1	<b>152</b> <i>943</i>	<b>166</b> <i>1229</i>	<b>157</b> <i>937</i>	<b>182</b> <i>1342</i>	— —	— —
		1-1/4	<b>159</b> <i>1078</i>	<b>265</b> <i>1665</i>	<b>179</b> <i>1043</i>	<b>267</b> <i>1538</i>	— —	— —
		1-1/2	<b>154</b> <i>1450</i>	<b>340</b> <i>2027</i>	<b>209</b> <i>1357</i>	<b>342</b> <i>1712</i>	— —	— —

## FASTENERS IN LIGHT WEIGHT CONCRETE

PART NUMBER SERIES	SHANK DIA (INCH)	MINIMUM PENETRATION (INCH)	ALLOWABLE WORKING VALUES INSTALLED IN 3,000 PSI LIGHTWEIGHT CONCRETE ALLOWABLE LOAD - <i>Ultimate Load</i>			
			3,000 PSI LIGHTWEIGHT W/DECKING		3,000 PSI LIGHTWEIGHT	
			LOWER FLUTE TENSION	LOWER FLUTE SHEAR	TENSION	SHEAR
1500 SERIES	0.145	3/4	<b>76</b> <i>395</i>	<b>260</b> <i>1409</i>	<b>167</b> <i>837</i>	<b>179</b> <i>894</i>
		1	<b>134</b> <i>668</i>	<b>265</b> <i>1505</i>	<b>200</b> <i>998</i>	<b>228</b> <i>1141</i>
		1-1/4	<b>157</b> <i>784</i>	<b>269</b> <i>1344</i>	<b>333</b> <i>1664</i>	<b>400</b> <i>2090</i>
		1-1/2	<b>233</b> <i>1163</i>	<b>346</b> <i>1728</i>	<b>391</b> <i>1957</i>	<b>410</b> <i>2050</i>

**Note 1:** ALLOWABLE loads are shown in the **LARGE BOLD** font, *Ultimate* loads are shown in *smaller italic* font. **Note 2:** Testing conducted in accordance with ICC AC70 & ASTM E1190. **Note 3:** Safety factors are based on coefficient of variation. In accordance with ICC AC70, the safety factor will be no less than 5. **Note 4:** Values shown in concrete are for the fastener only. Connected members must be investigated separately. **Note 5:** Cyclic, fatigue, shock loads, and other design criteria may require a different safety factor. **Note 6:** Job site testing may be required to determine actual job site values. **Note 7:** Minimum edge distance is 3 inches unless otherwise approved. **Note 8:** For Sl: 1 lbf = 4.448 N, 1 inch = 25.4 mm, 1 ksi = 6.89MPa

## FASTENERS IN STEEL

PART NUMBER SERIES	SHANK DIA (INCH)	TYPE OF SHANK	INSTALLED IN A36 STRUCTURAL STEEL-STEEL THICKNESS (INCHES) ALLOWABLE LOAD - <i>Ultimate Load</i>									
			3/16		1/4		3/8		1/2		≥ 3/4	
			TENSION (LBS)	SHEAR (LBS)	TENSION (LBS)	SHEAR (LBS)	TENSION (LBS)	SHEAR (LBS)	TENSION (LBS)	SHEAR (LBS)	TENSION (LBS)	SHEAR (LBS)
1500	0.145	SMOOTH	<b>81</b> <i>790</i>	<b>373</b> <i>2039</i>	<b>181</b> <i>1269</i>	<b>273</b> <i>1642</i>	<b>397</b> <i>2169</i>	<b>489</b> <i>2771</i>	<b>243</b> <i>1328</i> <sup>8</sup>	<b>277</b> <i>1514</i> <sup>8</sup>	— —	— —
		KNURLED	<b>296</b> <i>1633</i>	<b>636</b> <i>3516</i>	<b>584</b> <i>3384</i>	<b>659</b> <i>3822</i>	<b>680</b> <i>3755</i>	<b>730</b> <i>4030</i>	<b>253</b> <i>1459</i> <sup>8</sup>	<b>293</b> <i>1632</i> <sup>8</sup>	— —	— —

PART NUMBER SERIES	SHANK DIA (INCH)	TYPE OF SHANK	INSTALLED IN A572 GRADE 50 STRUCTURAL STEEL-STEEL THICKNESS (INCHES) ALLOWABLE LOAD - <i>Ultimate Load</i>									
			3/16		1/4		3/8		1/2		≥ 3/4	
			TENSION (LBS)	SHEAR (LBS)	TENSION (LBS)	SHEAR (LBS)	TENSION (LBS)	SHEAR (LBS)	TENSION (LBS)	SHEAR (LBS)	TENSION (LBS)	SHEAR (LBS)
1500	0.145	SMOOTH	— —	— —	— —	— —	— —	— —	— —	— —	— —	— —
		KNURLED	<b>260</b> <i>1609</i>	<b>499</b> <i>3182</i>	<b>579</b> <i>3411</i>	<b>725</b> <i>4272</i>	<b>383</b> <i>2216</i> <sup>7</sup>	<b>595</b> <i>3431</i> <sup>7</sup>	— —	— —	— —	— —

**Note 1:** ALLOWABLE loads are shown in the **LARGE BOLD** font, *Ultimate* loads are shown in *smaller italic* font. **Note 2:** Testing conducted in accordance with ICC AC70 & ASTM E1190. **Note 3:** Safety factors are based on coefficient of variation. In accordance with ICC AC70, the safety factor will be no less than 5. **Note 4:** Cyclic, fatigue, shock loads, and other design criteria may require a different safety factor. **Note 5:** Job site testing may be required to determine actual job site values. **Note 6:** Values shown are for fasteners that have the entire pointed end of the fastener driven through the steel plate; except as noted below. **Note 7:** Fastener penetration is 3/8" minimum. **Note 8:** Fastener penetration is 7/16" minimum. **Note 9:** Fastener penetration is 1/2" minimum. **Note 10:** For Sl: 1 lbf = 4.448 N, 1 inch = 25.4 mm, 1 ksi = 6.89MPa.

Ramset fasteners may be specified by their type or catalog number to satisfy fastening requirements.

## PIN SPECIFICATIONS

- Made from AISI 1060-1065 steel. Austempered to a core hardness of 52-56 Rc
- Typical tensile strength: 270,000 psi
- Typical shear strength: 162,000 psi
- STANDARD FINISHES**  
Mechanical zinc plate to a minimum thickness of .0002 meets requirements of ASTM B695—Class 5 Type 1

## APPROVALS/LISTINGS

- ICC Evaluation Service, Inc.**  
#ESR-2690 Sill Plate  
#ESR-1799 Powder Pins & Clips
- City of Los Angeles**  
#RR-22668 Powder pins



## FASTENERS IN NORMAL WEIGHT CONCRETE

PART NUMBER SERIES	SHANK DIA (INCH)	MINIMUM PENETRATION (INCH)	INSTALLED IN SOLID CONCRETE CONCRETE COMPRESSIVE STRENGTH ALLOWABLE LOAD - <i>Ultimate Load</i>					
			2,000 PSI		4,000 PSI		6,000 PSI	
			TENSION (LBS)	SHEAR (LBS)	TENSION (LBS)	SHEAR (LBS)	TENSION (LBS)	SHEAR (LBS)
SP SERIES	0.150	3/4	— —	— —	<b>150</b> <i>803</i>	<b>105</b> <i>786</i>	<b>81</b> <i>493</i>	<b>82</b> <i>454</i>
SP SERIES	.150/.180	1	<b>154</b> <i>1043</i>	<b>200</b> <i>1173</i>	<b>243</b> <i>1307</i>	<b>175</b> <i>1037</i>	<b>189</b> <i>1125</i>	<b>210</b> <i>1177</i>
		1-1/4	<b>207</b> <i>1553</i>	<b>230</b> <i>1636</i>	<b>298</b> <i>1749</i>	<b>218</b> <i>1471</i>	<b>213</b> <i>1568</i>	<b>305</b> <i>1780</i>
		1-1/2	— —	— —	<b>384</b> <i>2126</i>	<b>391</b> <i>1957</i>	<b>239</b> <i>1886</i>	<b>594</b> <i>2968</i>

## FASTENERS IN LIGHT WEIGHT CONCRETE

PART NUMBER SERIES	SHANK DIA (INCH)	MINIMUM PENETRATION (INCH)	ALLOWABLE WORKING VALUES INSTALLED IN 3,000 PSI LIGHTWEIGHT CONCRETE ALLOWABLE LOAD - <i>Ultimate Load</i>			
			3,000 PSI LIGHTWEIGHT W/DECKING		3,000 PSI LIGHTWEIGHT	
			LOWER FLUTE TENSION	LOWER FLUTE SHEAR	TENSION	SHEAR
SP SERIES	.150/.180	1	<b>119</b> <i>593</i>	<b>336</b> <i>1679</i>	<b>226</b> <i>1129</i>	<b>250</b> <i>1249</i>
		1-1/4	<b>175</b> <i>957</i>	<b>372</b> <i>1860</i>	<b>329</b> <i>1644</i>	<b>377</b> <i>1885</i>
		1-1/2	<b>179</b> <i>1055</i>	<b>426</b> <i>2128</i>	<b>406</b> <i>2030</i>	<b>380</b> <i>1900</i>

**Note 1:** ALLOWABLE loads are shown in the **LARGE BOLD** font, *Ultimate* loads are shown in *smaller italic* font. **Note 2:** Testing conducted in accordance with ICC AC70 & ASTM E1190. **Note 3:** Safety factors are based on coefficient of variation. In accordance with ICC AC70, the safety factor will be no less than 5. **Note 4:** Values shown in concrete are for the fastener only. Connected members must be investigated separately. **Note 5:** Cyclic, fatigue, shock loads, and other design criteria may require a different safety factor. **Note 6:** Job site testing may be required to determine actual job site values. **Note 7:** For SI: 1 lbf = 4.448 N, 1 inch = 25.4 mm, 1 ksi = 6.89MPa

## FASTENERS IN STEEL

PART NUMBER SERIES	SHANK DIA (INCH)	TYPE OF SHANK	INSTALLED IN A36 STRUCTURAL STEEL-STEEL THICKNESS (INCHES) ALLOWABLE LOAD - <i>Ultimate Load</i>									
			3/16		1/4		3/8		1/2		≥ 3/4	
			TENSION (LBS)	SHEAR (LBS)	TENSION (LBS)	SHEAR (LBS)	TENSION (LBS)	SHEAR (LBS)	TENSION (LBS)	SHEAR (LBS)	TENSION (LBS)	SHEAR (LBS)
SP SERIES	0.150	SMOOTH	<b>385</b> <i>2107</i>	<b>662</b> <i>3618</i>	<b>445</b> <i>2549</i>	<b>477</b> <i>2736</i>	<b>393</b> <i>2145</i>	<b>574</b> <i>3137</i>	<b>948</b> <i>5180</i>	<b>597</b> <i>3500</i>	<b>234</b> <i>1244</i> <sup>8</sup>	<b>356</b> <i>1895</i> <sup>8</sup>

PART NUMBER SERIES	SHANK DIA (INCH)	TYPE OF SHANK	INSTALLED IN A572 GRADE 50 STRUCTURAL STEEL-STEEL THICKNESS (INCHES) ALLOWABLE LOAD - <i>Ultimate Load</i>									
			3/16		1/4		3/8		1/2		≥ 3/4	
			TENSION (LBS)	SHEAR (LBS)	TENSION (LBS)	SHEAR (LBS)	TENSION (LBS)	SHEAR (LBS)	TENSION (LBS)	SHEAR (LBS)	TENSION (LBS)	SHEAR (LBS)
SP SERIES	0.150	SMOOTH	<b>356</b> <i>2123</i>	<b>569</b> <i>3394</i>	<b>554</b> <i>3232</i>	<b>637</b> <i>3710</i>	<b>604</b> <i>3447</i>	<b>602</b> <i>3437</i>	<b>814</b> <i>4473</i> <sup>9</sup>	<b>820</b> <i>4503</i> <sup>9</sup>	<b>243</b> <i>1362</i> <sup>8</sup>	<b>381</b> <i>2141</i> <sup>8</sup>

**Note 1:** ALLOWABLE loads are shown in the **LARGE BOLD** font, *Ultimate* loads are shown in *smaller italic* font. **Note 2:** Testing conducted in accordance with ICC AC70 & ASTM E1190. **Note 3:** Safety factors are based on coefficient of variation. In accordance with ICC AC70, the safety factor will be no less than 5. **Note 4:** Cyclic, fatigue, shock loads, and other design criteria may require a different safety factor. **Note 5:** Job site testing may be required to determine actual job site values. **Note 6:** Values shown are for fasteners that have the entire pointed end of the fastener driven through the steel plate; except as noted below. **Note 7:** Fastener penetration is 3/8" minimum. **Note 8:** Fastener penetration is 7/16" minimum. **Note 9:** Fastener penetration is 1/2" minimum **Note 10:** For SI: 1 lbf = 4.448 N, 1 inch = 25.4 mm, 1 ksi = 6.89MPa.

Ramset fasteners may be specified by their type or catalog number to satisfy fastening requirements.

## PIN SPECIFICATIONS

- Made from AISI 1060-1065 steel. Austempered to a core hardness of 52-56 Rc
- Typical tensile strength: 270,000 psi
- Typical shear strength: 162,000 psi
- STANDARD FINISHES**  
Mechanical zinc plate to a minimum thickness of .0002 meets requirements of ASTM B695—Class 5 Type 1

## APPROVALS/LISTINGS

- ICC Evaluation Service, Inc.**  
#ESR-2690 Sill Plate  
#ESR-1799 Powder Pins & Clips
- City of Los Angeles**  
#RR-22668 Powder pins



## FASTENERS IN NORMAL WEIGHT CONCRETE

PART NUMBER SERIES	SHANK DIA (INCH)	MINIMUM PENETRATION (INCH)	INSTALLED IN SOLID CONCRETE CONCRETE COMPRESSIVE STRENGTH ALLOWABLE LOAD - <i>Ultimate Load</i>					
			2000 PSI		4000 PSI		6000 PSI	
			TENSION (LBS)	SHEAR (LBS)	TENSION (LBS)	SHEAR (LBS)	TENSION (LBS)	SHEAR (LBS)
TE	0.157	3/4	<b>71</b> 627	<b>116</b> 713	<b>71</b> 559	<b>116</b> 685	<b>109</b> 753	<b>117</b> 712
		1	<b>197</b> 986	<b>216</b> 1463	<b>258</b> 1390	<b>216</b> 1421	<b>214</b> 1313	<b>383</b> 1998
		1-1/4	<b>264</b> 1399	<b>283</b> 1626	<b>377</b> 1886	<b>317</b> 1846	<b>415</b> 2074	<b>349</b> 1858
		1-1/2	<b>212</b> 1453	<b>297</b> 1719	<b>242</b> 1211	<b>479</b> 2393		

## FASTENERS IN LIGHT WEIGHT CONCRETE

PART NUMBER SERIES	SHANK DIA (INCH)	EMBED (INCHES)	3000 PSI LIGHT WEIGHT CONCRETE	
			TENSION (LBS)	SHEAR (LBS)
TE SERIES	0.157	3/4	<b>152</b> 1010	<b>159</b> 998
		1	<b>325</b> 1625	<b>347</b> 1737
		1-1/4	<b>358</b> 1790	<b>437</b> 2239
		1-1/2	<b>466</b> 2332	<b>478</b> 2392

**Note 1:** ALLOWABLE loads are shown in the **LARGE BOLD** font, *Ultimate* loads are shown in *smaller italic* font. **Note 2:** Testing conducted in accordance with ICC AC70 & ASTM E1190. **Note 3:** Safety factors are based on coefficient of variation. In accordance with ICC AC70, the safety factor will be no less than 5. **Note 4:** Values shown in concrete are for the fastener only. Connected members must be investigated separately. **Note 5:** Cyclic, fatigue, shock loads, and other design criteria may require a different safety factor. **Note 6:** Job site testing may be required to determine actual job site values. **Note 7:** Minimum edge distance is 3 inches unless otherwise approved. **Note 8:** For Sl: 1 lbf = 4.448 N, 1 inch = 25.4 mm, 1 ksi = 6.89MPa

## INSTALLED IN A36 STRUCTURAL STEEL (INCHES)

PART NUMBER SERIES	SHANK DIA (INCH)	SHANK TYPE	3/16		1/4		3/8		1/2		≥3/4	
			TENSION	SHEAR	TENSION	SHEAR	TENSION	SHEAR	TENSION	SHEAR	TENSION	SHEAR
TE SERIES	0.157	KNURLED	<b>323</b> 1739	<b>606</b> 3257	<b>562</b> 3022	<b>673</b> 3621	<b>934</b> 5095	<b>820</b> 4473	<b>603</b> 3286	<b>766</b> 4178	<b>343</b> <sup>5</sup>	<b>496</b> <sup>6</sup>

## INSTALLED IN A572-GR50 STRUCTURAL STEEL (INCHES)

PART NUMBER SERIES	SHANK DIA (INCH)	SHANK TYPE	3/16		1/4		3/8		1/2		≥3/4	
			TENSION	SHEAR	TENSION	SHEAR	TENSION	SHEAR	TENSION	SHEAR	TENSION	SHEAR
TE SERIES	0.157	KNURLED	<b>442</b> 2400	<b>676</b> 3674	<b>630</b> 3747	<b>662</b> 3942	<b>760</b> 4421	<b>725</b> 4218	<b>582</b> <sup>5</sup> 3118	<b>532</b> <sup>5</sup> 2851	<b>311</b> <sup>5</sup>	<b>469</b> <sup>5</sup>

Notes:

- Fasteners tested to ASTM E1190 & ICC-ES AC70
- Allowable loads are shown in **bold font**, ultimate loads are shown in smaller, *italic font*
- Allowable loads and safety factors are based on coefficient of variation in accordance with ICC AC70, the safety factor will be no less than 5
- Values shown for steel base materials have the pointed end of the fastener driven through the steel plate
- Fastener penetration into steel must be minimum 7/16 inch
- Fastener penetration into steel must be minimum 3/8 inch
- For Sl: 1 lbf = 4.448 N, 1 inch = 25.4 mm, 1 ksi = 6.89MPa





Ramset fasteners may be specified by their type or catalog number to satisfy fastening requirements.

## PIN SPECIFICATIONS

- Made from AISI 1060-1065 steel. Austempered to a core hardness of 52-56 Rc
- Typical tensile strength: 270,000 psi
- Typical shear strength: 162,000 psi
- STANDARD FINISHES**  
Mechanical zinc plate to a minimum thickness of .0002 meets requirements of ASTM B695—Class 5 Type 1

## APPROVALS/LISTINGS

- ICC Evaluation Service, Inc.**  
#ESR-2690 Sill Plate  
#ESR-1799 Powder Pins & Clips
- City of Los Angeles**  
#RR-22668 Powder pins



## FASTENERS INSTALLED THROUGH METAL DECK INTO MINIMUM 3,000 PSI LIGHTWEIGHT CONCRETE

PART NUMBER SERIES	SHANK DIA (INCH)	SHANK DESCRIPTION	MINIMUM PENETRATION (INCH)	3-INCH DEEP W TYPE STEEL DECK		1 1/2 INCH DEEP B TYPE STEEL DECK			
						UPPER FLUTE		LOWER FLUTE	
				TENSION (LBS)	SHEAR (LBS)	TENSION (LBS)	SHEAR (LBS)	TENSION (LBS)	SHEAR (LBS)
TE	0.157	Smooth-tapered	3/4	<b>106</b> 529	<b>265</b> 1326	<b>131</b> 656	<b>261</b> 1305	<b>154</b> 769	<b>307</b> 1537
			1	<b>152</b> 761	<b>327</b> 1634	<b>156</b> 782	<b>273</b> 1365	<b>138</b> 692	<b>265</b> 1326
			1-1/4	<b>164</b> 821	<b>330</b> 1650	— —	— —	— —	— —
			1-1/2	<b>238</b> 1191	<b>448</b> 2240	— —	— —	— —	— —

**Note 1:** ALLOWABLE loads are shown in the **LARGE BOLD** font, *Ultimate* loads are shown in *smaller italic* font. **Note 2:** Testing conducted in accordance with ICC AC70 & ASTM E1190. **Note 3:** Safety factors are based on coefficient of variation. In accordance with ICC AC70, the safety factor will be no less than 5. **Note 4:** Values shown in concrete are for the fastener only. Connected members must be investigated separately. **Note 5:** Cyclic, fatigue, shock loads, and other design criteria may require a different safety factor. **Note 6:** Job site testing may be required to determine actual job site values. **Note 7:** Minimum edge distance is 3 inches unless otherwise approved. **Note 8:** For Sl: 1 lbf = 4.448 N, 1 inch = 25.4 mm, 1 ksi = 6.89MPa

## FASTENERS DRIVEN INTO CONCRETE MASONRY UNITS (CMU BLOCK)

PART NUMBER SERIES	SHANK DIA (INCH)	EMBED	HOLLOW UNGROUTED CMU				GROUT-FILLED CMU					
			FACE SHELL		MORTAR JOINT		FACE SHELL		MORTAR JOINT		TOP OF GROUTED CELL	
			TENSION	SHEAR	TENSION	SHEAR	TENSION	SHEAR	TENSION	SHEAR	TENSION	SHEAR
TE	0.157	1	<b>33</b> 329	<b>100</b> 693	<b>42</b> 443	<b>68</b> 746	<b>139</b> 875	<b>145</b> 936	<b>91</b> 950	<b>127</b> 1328	<b>165</b> 851	<b>171</b> 922

For Sl: 1 Inch = 25.4 mm, 1 lbf = 4.448 N.

Fasteners must be installed a minimum of 5.1 inches from the end of the wall.

Fasteners must be installed at the center of the CMU cell. No more than one fastener may be installed in an individual CMU cell

Applicable to fasteners installed in the horizontal mortar joint (bed joint). Minimum fastener spacing must be 5.1 inches

Allowable shear load value applies to load applied perpendicular to the mortar joint

Fastener must be installed vertically at the top, center of grouted cell

Shear load can be in any direction perpendicular to the axis of the fastener

TE Embedment depth is easily identifiable by head stamps.



**Angle Clip in Concrete**

PART NUMBER SERIES	SHANK DIAMETER (INCH)	MINIMUM PENETRATION (INCH)	INSTALLED IN NORMAL WEIGHT CONCRETE CONCRETE COMPRESSIVE STRENGTH ALLOWABLE LOAD - <i>Ultimate Load</i>					
			4000 PSI			6000 PSI		
			TENSION (LBS)	SHEAR (LBS)	OBLIQUE (LBS)	TENSION (LBS)	SHEAR (LBS)	OBLIQUE (LBS)
SDC100 SDC125	0.145	7/8	<b>115</b> <i>575</i>	<b>120</b> <i>1014</i>	<b>145</b> <i>726</i>	— —	— —	— —
SDC125	0.145	1-1/8	<b>130</b> <i>744</i>	<b>167</b> <i>1090</i>	<b>205</b> <i>1032</i>	— —	— —	— —
SPC78	0.150	3/4	<b>155</b> <i>897</i>	<b>188</b> <i>1050</i>	— —	<b>150</b> <i>788</i>	<b>153</b> <i>949</i>	<b>140</b> <i>769</i>
SPC114	.150/.180	1-1/8	<b>127</b> <i>811</i>	<b>226</b> <i>1130</i>	<b>181</b> <i>904</i>	<b>169</b> <i>853</i>	<b>300</b> <i>1500</i>	<b>223</b> <i>1114</i>

PART NUMBER SERIES	SHANK DIAMETER (INCH)	MINIMUM PENETRATION (INCH)	ALLOWABLE WORKING VALUES INSTALLED IN 3000 PSI LIGHTWEIGHT CONCRETE ALLOWABLE LOAD - <i>Ultimate Load</i>				
			3000 PSI LIGHTWEIGHT WITH METAL DECKING				
			LOWER FLUTE TENSION (LBS)	LOWER FLUTE SHEAR (LBS)	LOWER FLUTE OBLIQUE (LBS)	UPPER FLUTE TENSION (LBS)	UPPER FLUTE SHEAR (LBS)
SDC100 SDC125	0.145	7/8	<b>67</b> <i>335</i>	<b>237</b> <i>1186</i>	<b>90</b> <i>448</i>	<b>104</b> <i>571</i>	<b>310</b> <i>1678</i>
SDC125	0.145	1-1/8	<b>94</b> <i>471</i>	<b>276</b> <i>1378</i>	<b>119</b> <i>596</i>	<b>106</b> <i>528</i>	<b>319</b> <i>1597</i>
SPC78	0.150	3/4	<b>59</b> <i>293</i>	<b>202</b> <i>1109</i>	<b>65</b> <i>323</i>	<b>84</b> <i>419</i>	<b>324</b> <i>1622</i>
SPC114	.150/.180	1-1/8	<b>157</b> <i>786</i>	<b>272</b> <i>1358</i>	<b>153</b> <i>766</i>	<b>180</b> <i>899</i>	<b>334</b> <i>1673</i>

**Note 1:** ALLOWABLE loads are shown in the **LARGE BOLD** font, *Ultimate* loads are shown in *smaller italic* font. **Note 2:** Testing conducted in accordance with ICC AC70 & ASTM E1190. **Note 3:** Safety factors are based on coefficient of variation. In accordance with ICC AC70, the safety factor will be no less than 5. **Note 4:** Values shown in concrete are for the clip assembly only. Connected members must be investigated separately. **Note 5:** Cyclic, fatigue, shock loads, and other design criteria may require a different safety factor. **Note 6:** Job site testing may be required to determine actual job site values. **Note 7:** Minimum edge distance is 3 inches unless otherwise approved. **Note 8:** For Sl: 1 lbf = 4.448 N, 1 inch = 25.4 mm, 1 ksi = 6.89MPa. **Note 9:** Metal deck is 20g. Ceiling clips = ASTM A653





**Ramset**<sup>®</sup>  
**DRIVING JOBSITE SPEED**

**NATIONAL HEADQUARTERS**

ITW COMMERCIAL CONSTRUCTION,  
NORTH AMERICA  
155 HARLEM AVE,  
GLENVIEW IL 60025  
PHONE: 800-848-5611  
FAX: 630-893-1270

**TECHNICAL SUPPORT**

PHONE: 800-848-5611  
HOURS: 8:30 A.M. - 5:00 P.M. (CST, M-F)  
EMAIL: TECHSUPPORT@ITWCCNA.COM

**WILL CALL/DISTRIBUTION**

2501 GALVIN DR  
ELGIN, IL 60123  
PHONE: 800-848-5611

**CUSTOMER SERVICE**

PHONE: 800-848-5611  
HOURS: 7:30 A.M. - 5:00 P.M. (CST, M-F)  
EMAIL: ORDERS@ITWCCNA.COM

**[www.ramset.com](http://www.ramset.com)**