

# LP<sup>®</sup> SOLIDSTART<sup>®</sup> LSL & LVL WALL FRAMING

U.S. (ASD) TECHNICAL GUIDE

---

1.35E, 1.55E, and 1.75E LSL  
2.0E LVL

**LP** SolidStart<sup>®</sup>  
ENGINEERED WOOD



U.S. Technical Guide

## Introduction

# A Word About Wall Framing

Architects are raising the roof and stretching walls beyond the reach of conventional lumber. LP® SolidStart® LSL and LVL studs redefine the standard for wall framing by providing structural walls that can be straighter, taller and stronger for both conventional and challenging engineered applications. Because LP manufactures its LSL and LVL to high standards, builders know that they'll get fewer callbacks and save themselves time and money compared to dimension lumber products.

Where traditional lumber studs warp, bow and twist as they dry, LP SolidStart LSL and LVL won't because they start dry from the mill. Having straight walls gives home-owners the peace of mind that their cabinets will stay flush to the wall, their tile and drywall is less likely to crack and their windows and doors will function properly. That's performance you can count on.

Using this technical guide, LP SolidStart LSL and LVL can be specified for use in conventional (prescriptive) and engineered wood-frame wall construction.

## CONVENTIONAL CONSTRUCTION

Conventional construction provisions for wood-frame walls are included in the International Building Code (IBC) and the International Residential Code (IRC). In conventional construction, wall members and their connections are selected from tables in the Code rather than being calculated, as in engineered design.

LP's compliance with the ICC Evaluation Service's Acceptance Criteria for Wood-Based Studs (AC202) permits LP SolidStart LSL and LVL to be a direct substitution to traditional lumber studs defined in the IBC and the IRC.

Compliance with AC202 also demonstrates equivalence to the notching provisions prescribed in the Code for traditional lumber studs in conventional construction.

## FIRE-RESISTIVE WALL CONSTRUCTION

LP SolidStart LSL and LVL (1.5E and higher) are permitted to be used in the 1-hour fire-resistance-rated wall assemblies listed in the IBC, with some additional design and construction considerations as specified in LP's evaluation and product reports. When used in prescriptive wall framing, LP SolidStart LSL and LVL can be directly substituted for the equivalent size of dimensional lumber. When used in engineered wall construction, some additional limitations are imposed on the load capacity of the studs. Please refer to ICC-ES evaluation

report ESR-2403 and APA product report PR-L280 for complete information on the use of LP SolidStart LSL and LVL in fire-resistance-rated walls, or use LP's Design software.

## ENGINEERED DESIGN CONSTRUCTION

In engineered design, calculations based on the expected in-service loads are performed to ensure that the allowable capacities of the wall members are not exceeded.

Notches and holes in LP SolidStart LSL and LVL wall framing are permitted when designed in accordance with the provisions of the National Design Specification for Wood Construction (NDS), with additional adjustments as prescribed herein. The wall stud and exterior wall column tables in this guide include the effects of notches and holes on their capacity. Refer to Drilling & Notching on page 4 for the limitations of notch and hole size and location.

## DEFLECTION LIMITS

Like floor and roof systems, walls are subject to code-prescribed deflection limits as well as industry recommendations. The IBC prescribes a deflection ratio limit of L/240 for walls with brittle finishes and L/120 for walls with flexible finishes. The IRC prescribes the additional ratio of L/360 for walls with stucco or plaster. Additional deflection limits are recommended for certain windows and wall finishes like brick. Always verify the requirements, but the following table summarizes common deflection limits.

## LIFETIME LIMITED WARRANTY

LP SolidStart Engineered Wood Products are backed by a lifetime limited warranty. Visit LPCorp.com or call 1.888.820.0325 for a copy of the warranty.

Condition	Deflection
Flexible Finish (IBC)	L/120
Windows & Doors	L/175
Brittle Finish (IBC)	L/240
Plaster & Stucco (IRC)	L/360
Brick	L/600



# Table of Contents

Product Specifications, Design Values and Drilling & Notching. . . . .	4
Wall Stud Capacity (plf) . . . . .	5
2x4 & 2x6 Exterior Wall Column Capacity (lbs):	
115 mph IBC/IRC 2018, Exposure B . . . . .	6
130 mph IBC/IRC 2018, Exposure C. . . . .	7
2x8 Exterior Wall Column Capacity (lbs):	
115 mph IBC/IRC 2018, Exposure B . . . . .	8
130 mph IBC/IRC 2018, Exposure C. . . . .	9
2x10 Exterior Wall Column Capacity (lbs):	
115 mph IBC/IRC 2018, Exposure B . . . . .	10
130 mph IBC/IRC 2018, Exposure C. . . . .	11
Typical Wall Framing Examples	
Wall Stud Example . . . . .	12
Trimmer & King Stud Examples . . . . .	13
Wall Column Examples . . . . .	14
Free-Standing Interior Column Capacity (lbs) . . . . .	15
Nailing and Connection Details . . . . .	16-17
Typical Connections . . . . .	18
Handling and Storage Guidelines and Product Availability. . . . .	20



# Product Specifications, Design Values and Drilling & Notching

## ALLOWABLE STRESS DESIGN VALUES (PSI)

Material	Grade	Beam (Edgewise) Orientation				Plank (Flatwise) Orientation				Axial	
		Bending $F_b^{3,4,5}$	Modulus of Elasticity $MOE^{10}$ ( $\times 10^9$ )	Shear $F_v$	Compression perpendicular-to-grain $F_{c\perp}$	Bending $F_b^5$	Modulus of Elasticity $MOE^{10}$ ( $\times 10^9$ )	Shear $F_v$	Compression perpendicular-to-grain $F_{c\perp}^6$	Tension $F_t^{7,8}$	Compression $F_c$
LP® SolidStart® LSL	1.35E	1730	1.35	410	750	1910	1.35	155	685	1300	1650
	1.55E	2360	1.55	410	875	2620	1.55	155	775	1750	2175
	1.75E	2500	1.75	410	950	2800	1.75	155	890	2100	2450
LP SolidStart LVL	2900F <sub>v</sub> -2.0E	2900	2.0	285	750	2950	2.0	140	550	1800	3200

### NOTES:

- LP SolidStart LSL and LVL shall be designed for dry-use conditions only. Dry-use applies to products installed in dry, covered and well ventilated interior conditions in which the equivalent moisture content in lumber will not exceed 16%. Adjustments for high temperature are beyond the scope of this guide.
- The allowable strengths and stiffness are for normal load duration (10 year). Bending, Shear and Axial Tension and Compression shall be adjusted according to code. Modulus of Elasticity and Compression perpendicular-to-grain shall not be adjusted for load duration.
- The allowable Bending,  $F_b$ , for LP SolidStart LSL in the Beam orientation is tabulated for a standard 12" depth. For depths other than 12", multiply  $F_b$  by  $(12/\text{depth})^{0.120}$ . For depths less than 3-1/2", adjust  $F_b$  by 1.159.
- The allowable Bending,  $F_b$ , for LP SolidStart LVL in the Beam orientation is tabulated for a standard 12" depth. For depths less than 12", multiply  $F_b$  by  $(12/\text{depth})^{0.111}$ . For depths less than 3-1/2", multiply  $F_b$  by 1.147. For depths greater than 12", multiply  $F_b$  by  $(12/\text{depth})^{0.143}$ .
- The allowable Bending,  $F_b$ , in the Plank orientation shall not be adjusted for depth (thickness).
- The allowable edgewise Bending shall also be multiplied by the repetitive member factor,  $C_r = 1.04$ , when 3 or more pieces are properly connected in direct contact or are used as wall studs spaced no more than 24" oc and properly connected together by an adequate wall sheathing.
- The allowable Tension,  $F_t$ , for LP SolidStart LSL is assigned for a standard length of 3 feet. For lengths longer than 3 feet, multiply  $F_t$  by  $(3/\text{length})^{0.092}$ . For lengths less than 3 feet, use the design tension stresses in the table above, unadjusted.
- The allowable Tension,  $F_t$ , for LP SolidStart LVL is assigned for a standard length of 3 feet. For lengths longer than 3 feet, multiply  $F_t$  by  $(3/\text{length})^{0.111}$ . For lengths less than 3 feet, use the design tension stresses in the table above, unadjusted.
- The NDS bearing area factor,  $C_a$ , is permitted to be applied to the reference compression perpendicular-to-grain design values.
- Deflection calculations for LP SolidStart LSL and LVL shall include both bending and shear deformations.

$$\text{Deflection for wall framing, uniform load: } \Delta = \frac{270wL^4}{Eb d^3} + \frac{28.8wL^2}{Ebd}$$

Where:  $\Delta$  = deflection (in)      E = modulus of elasticity (from table)  
 $w$  = uniform load (plf)      b = width (in)  
 $L$  = design span (ft)      d = depth (in direction of bending) (in)

Equations for other conditions can be found in engineering references.

### PRODUCT ORIENTATION

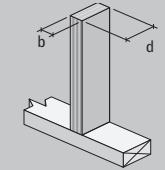

Beam (Edgewise)

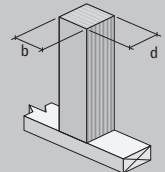

Plank (Flatwise)

## BEARING CAPACITY

Stud or Column Size	Column Bearing (lbs.)						Stud Bearing (plf)									
	Hem-Fir (405 psi)	SPF (425 psi)	LP-LVL (550 psi)	LP 1.35E LSL (685 psi)	LP 1.55E LSL (775 psi)	Concrete (2500 psi)	Hem-Fir (405 psi)		SPF (425 psi)		LP-LVL (550 psi)		LP 1.35E LSL (685 psi)		LP 1.55E LSL (775 psi)	
	12" oc	16" oc	12" oc	16" oc	12" oc	16" oc	12" oc	16" oc	12" oc	16" oc	12" oc	16" oc	12" oc	16" oc	12" oc	16" oc
1-1/2" x 3-1/2"	2126	2231	2887	3596	4068	4462	2126	1594	2231	1673	2887	2165	3596	2697	4068	3051
1-1/2" x 5-1/2"	3341	3506	4537	5651	6393	7012	3341	2505	3506	2629	4537	3403	5651	4238	6393	4795
1-1/2" x 7-1/4"	4404	4621	5981	7449	8428	9243	4404	3303	4621	3466	5981	4485	7449	5587	8428	6321
1-1/2" x 9-1/4"	5619	5896	7631	9504	10753	11793	5619	4214	5896	4422	7631	5723	9504	7128	10753	8064
3-1/2" x 3-1/2"	4961	5206	6737	8391	9493	10412										
3-1/2" x 5-1/2"	7796	8181	10587	13186	14918	16362										
3-1/2" x 7-1/4"	10276	10784	13956	17381	19665	21568										
3-1/2" x 9-1/4"	13111	13759	17806	22176	25090	27518										
5-1/4" x 5-1/2"	11694	12271	15881	19779	22378	24543										
5-1/4" x 7-1/4"	15415	16176	20934	26072	29498	32353										
5-1/4" x 9-1/4"	19667	20639	26709	33265	37635	41278										

### NOTES:

- The capacity for Wood Bearing is based on the compression strength, perpendicular-to-grain, of the bearing plate and shall not be adjusted for load duration.
- The Bearing Capacity for concrete is based on a conversion to allowable stress design for comparison to the column capacities in this guide.
- To determine the Bearing Capacity of a multiple-ply member (such as a double 2 x 4 stud), multiply the Bearing Capacity from the table by the number of plies. The capacity is additive and may be increased for bearing on wood plates per note 4.
- When a stud or column is located at least 3" from the end of a wall plate, the Bearing Capacities above are permitted to be increased by the bearing area factor,  $C_b = (L_b + 0.375)/L_b$ , where  $L_b$  is the bearing length measured parallel to the grain of the wall plate and is less than 6". For bearing lengths 6" or more,  $C_b = 1.00$ .

## DRILLING & NOTCHING

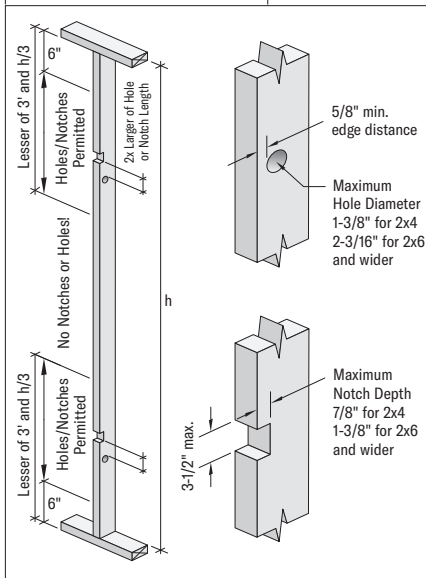

### NOTES:

- Free-standing columns shall not be drilled or notched except as required for proper installation of column caps, bases or other hold-downs without further analysis by a professional engineer. Bolts, lag screws and self-tapping screws shall only be inserted through the face of the column, perpendicular to the face of the strands in LP LSL and the veneers in LP LVL.
- Cutting, notching and boring of nominal 2x4 (1-1/2" x 3-1/2") and 2x6 (1-1/2" x 5-1/2") LP LSL and LP LVL wall studs used in prescriptive wall framing is permitted in accordance with sections 2308.9.10 and 2308.9.11 of the IBC and section R602.6 of the International Residential Code (IRC).
- For wall applications designed with the tables in this guide, notching and drilling shall be limited to the restrictions of notes 4 through 6 (see details to left).
- One hole up to 40% of the stud depth, maximum of 2-3/16", is allowed only in the upper or lower 3 feet or 1/3 of the stud height, h (see Drilling and Notching detail for maximum hole sizes), except do not place a hole within 6" of either end of the stud. Two small holes up to 1" diameter and vertically spaced no closer than 12" oc are permitted in studs with a depth of at least 5-1/2".
- One notch up to 25% of the stud depth, maximum of 1-3/8", is allowed only in the upper or lower 3 feet or 1/3 of the stud height, h (see Drilling and Notching detail for maximum notch sizes), except do not place a notch within 6" of either end of the stud. The notch length shall not exceed 3-1/2".
- Do NOT cut a hole and a notch at the same cross-section. Maintain a clear vertical separation of at least twice the length of the notch or twice the diameter of the hole, whichever is greater.
- For engineered wall applications beyond the scope of this guide, design for notching and drilling shall be based on a net section analysis in accordance with the provisions of the NDS including the restrictions listed in APA product report PR-L280 and ICC-ES evaluation report ESR-2403. When designing with holes or notches the allowable design stresses for bending, axial compression and axial tension shall be reduced by the Strength Reduction Factors (tabulated below) to account for stress concentrations.

### STRENGTH REDUCTION FACTORS

Material	Notch			Hole		
	Bending	Compression	Tension	Bending	Compression	Tension
LP SolidStart LSL	0.95	0.90	0.75	1.00	1.00	1.00
LP SolidStart LVL	0.80	0.90	0.60	0.95	0.95	0.95

# Wall Stud Capacity (plf)

## TO USE:

1. Select the table for wind speed and exposure category.
2. Determine the height of the wall stud. If not listed, select the next tallest Height in the table.
3. Select the row for the desired Spacing.
4. Select the LP® SolidStart® LSL or LVL grade and size where the Vertical Load Capacity and Deflection Ratio meet or exceed the applied vertical load and required deflection limit.
5. Verify the plate bearing capacity for the selected stud. See Additional Note 9 below.

115 MPH IBC/IRC 2018, EXPOSURE B*												
Height	Tributary Width	1.35E LP LSL			1.55E LP LSL				2.0E LP LVL			
		1-1/2" x 3-1/2"	1-1/2" x 5-1/2"	1-1/2" x 7-1/4"	1-1/2" x 3-1/2"	1-1/2" x 5-1/2"	1-1/2" x 7-1/4"	1-1/2" x 9-1/4"	1-1/2" x 5-1/2"	1-1/2" x 7-1/4"	1-1/2" x 9-1/4"	
8'	12"	2739 L/462	5631 L/611	7422 L/708	3327 L/470	6372 L/575	8400 L/641	10717 L/753	5632 L/627	7424 L/688	9472 L/797	
	16"	2054 L/408	4223 L/588	5567 L/694	2495 L/419	4779 L/557	6300 L/630	8038 L/745	4224 L/612	5568 L/679	7104 L/791	
9'	12"	2340 L/405	5628 L/583	7419 L/662	2820 L/420	6370 L/559	8396 L/608	10713 L/695	5630 L/614	7421 L/658	9468 L/742	
	16"	1595 L/346	4221 L/554	5564 L/644	2087 L/364	4777 L/535	6297 L/595	8034 L/687	4222 L/593	5566 L/647	7101 L/735	
10'	12"	1883 L/345	5457 L/555	7416 L/627	2412 L/365	6367 L/542	8393 L/586	10708 L/653	5627 L/599	7418 L/638	9464 L/701	
	16"	1257 L/275	4093 L/517	5562 L/606	1673 L/307	4775 L/509	6295 L/569	8031 L/643	4220 L/570	5563 L/624	7098 L/693	
12'	12"	1257 L/218	4487 L/490	7409 L/578	1651 L/251	5478 L/494	8386 L/557	10699 L/602	5622 L/557	7412 L/612	9456 L/653	
	16"	802 L/163	3365 L/438	5557 L/546	1112 L/188	4108 L/447	6289 L/530	8024 L/586	4217 L/511	5559 L/588	7092 L/639	
14'	12"	865 L/140	3679 L/414	6704 L/532	1169 L/161	4439 L/430	8294 L/527	10691 L/573	5433 L/496	7405 L/585	9448 L/627	
	16"	-	2759 L/356	5028 L/489	764 L/120	3329 L/374	6220 L/489	8018 L/551	4075 L/438	5554 L/549	7086 L/607	
16'	12"	-	3044 L/340	5776 L/482	-	3646 L/362	7046 L/489	10682 L/551	4490 L/428	7399 L/551	9440 L/607	
	16"	-	2139 L/277	4332 L/429	-	2734 L/304	5284 L/440	8011 L/521	3368 L/365	5549 L/503	7080 L/579	
18'	12"	-	2449 L/264	4971 L/426	-	3037 L/297	6014 L/442	10395 L/527	3760 L/358	7345 L/507	9432 L/585	
	16"	-	1668 L/198	3728 L/368	-	2167 L/227	4511 L/386	7796 L/487	2753 L/293	5509 L/450	7074 L/548	
20'	12"	-	1969 L/195	4298 L/370	-	2505 L/224	5165 L/391	9154 L/497	3189 L/289	6344 L/456	9424 L/558	
	16"	-	1321 L/146	3224 L/311	-	1737 L/168	3874 L/332	6866 L/449	2219 L/217	4758 L/394	7068 L/512	
22'	12"	-	1599 L/149	3741 L/318	-	2058 L/171	4475 L/341	8076 L/462	2630 L/220	5519 L/404	9417 L/526	
	16"	-	-	2791 L/254	-	1410 L/128	3356 L/283	6057 L/409	1813 L/165	4139 L/341	7062 L/472	
24'	12"	-	-	3282 L/265	-	1682 L/133	3907 L/295	7154 L/425	2197 L/172	4838 L/354	8757 L/489	
	16"	-	-	2272 L/199	-	-	2930 L/228	5365 L/368	1499 L/129	3629 L/292	6567 L/430	
26'	12"	-	-	2771 L/212	-	-	3438 L/243	6368 L/387	1854 L/137	4272 L/308	7823 L/450	
	16"	-	-	1852 L/159	-	-	2448 L/182	4776 L/330	-	3204 L/235	5867 L/388	
28'	12"	-	-	2309 L/171	-	-	2987 L/197	5695 L/349	-	3795 L/254	7020 L/410	
	16"	-	-	1508 L/128	-	-	2036 L/147	4271 L/292	-	2816 L/190	5265 L/346	
30'	12"	-	-	1928 L/141	-	-	2533 L/162	5119 L/313	-	3393 L/209	6333 L/371	
	16"	-	-	-	-	-	1699 L/121	3839 L/251	-	2380 L/156	4749 L/308	

\*Applies to: 115 mph IBC/IRC 2015 and IBC 2012; 90 mph IBC 2009 and IRC 2009/2012

130 MPH IBC/IRC 2018, EXPOSURE C*												
Height	Tributary Width	1.35E LP LSL			1.55E LP LSL				2.0E LP LVL			
		1-1/2" x 3-1/2"	1-1/2" x 5-1/2"	1-1/2" x 7-1/4"	1-1/2" x 3-1/2"	1-1/2" x 5-1/2"	1-1/2" x 7-1/4"	1-1/2" x 9-1/4"	1-1/2" x 5-1/2"	1-1/2" x 7-1/4"	1-1/2" x 9-1/4"	
8'	12"	2499 L/354	5631 L/561	7422 L/676	3316 L/368	6372 L/535	8400 L/617	10717 L/736	5632 L/593	7424 L/669	9472 L/784	
	16"	1608 L/293	4223 L/529	5567 L/654	2248 L/315	4779 L/508	6300 L/601	8038 L/723	4224 L/569	5568 L/655	7104 L/774	
9'	12"	1853 L/280	5628 L/520	7419 L/624	2540 L/309	6370 L/506	8396 L/579	10713 L/676	5630 L/567	7421 L/633	9468 L/726	
	16"	1115 L/210	4221 L/480	5564 L/597	1662 L/241	4777 L/471	6297 L/559	8034 L/661	4222 L/535	5566 L/616	7101 L/714	
10'	12"	1412 L/207	5457 L/475	7416 L/580	1997 L/238	6367 L/472	8393 L/549	10708 L/630	5627 L/535	7418 L/606	9464 L/682	
	16"	730 L/155	4093 L/428	5562 L/548	1265 L/178	4775 L/430	6295 L/523	8031 L/613	4220 L/495	5563 L/583	7098 L/667	
12'	12"	829 L/123	4487 L/385	7409 L/509	1272 L/142	5478 L/397	8386 L/499	10699 L/567	5622 L/462	7412 L/559	9456 L/623	
	16"	-	3093 L/331	5557 L/466	-	4108 L/345	6289 L/462	8024 L/544	4217 L/408	5559 L/524	7092 L/602	
14'	12"	-	3389 L/300	6704 L/442	-	4434 L/319	8294 L/446	10691 L/525	5433 L/381	7405 L/509	9448 L/583	
	16"	-	2216 L/229	5028 L/390	-	3034 L/263	6220 L/399	8018 L/492	3822 L/323	5554 L/462	7086 L/553	
16'	12"	-	2551 L/209	5776 L/375	-	3392 L/240	7046 L/390	10682 L/485	4293 L/306	7399 L/453	9440 L/546	
	16"	-	1609 L/157	4332 L/321	-	2274 L/180	5284 L/337	8011 L/445	2893 L/232	5549 L/398	7080 L/507	
18'	12"	-	1946 L/149	4971 L/313	-	2638 L/172	6014 L/332	10395 L/444	3365 L/221	7345 L/393	9432 L/506	
	16"	-	-	3605 L/255	-	1730 L/129	4511 L/278	7796 L/396	2219 L/166	5509 L/335	7074 L/458	
20'	12"	-	-	4217 L/252	-	2086 L/127	5165 L/279	9154 L/400	2676 L/164	6344 L/336	9424 L/462	
	16"	-	-	2794 L/189	-	-	3763 L/217	6866 L/347	1727 L/123	4758 L/278	7068 L/408	
22'	12"	-	-	3348 L/192	-	-	4420 L/221	8076 L/356	2156 L/125	5519 L/283	9417 L/417	
	16"	-	-	2137 L/144	-	-	2978 L/166	6057 L/304	-	3998 L/214	7062 L/359	
24'	12"	-	-	2654 L/150	-	-	3593 L/173	7154 L/315	-	4838 L/223	8757 L/371	
	16"	-	-	-	-	-	2360 L/129	5365 L/263	-	3352 L/167	6567 L/313	
26'	12"	-	-	-	-	-	2923 L/137	6368 L/276	-	4090 L/177	7823 L/328	
	16"	-	-	-	-	-	-	4583 L/213	-	2710 L/133	5867 L/271	
28'	12"	-	-	-	-	-	-	5664 L/231	-	3395 L/144	7020 L/289	
	16"	-	-	-	-	-	-	3825 L/173	-	-	5265 L/223	
30'	12"	-	-	-	-	-	-	4810 L/189	-	-	6333 L/245	
	16"	-	-	-	-	-	-	3186 L/142	-	-	4504 L/183	

\*Applies to: 130 mph IBC/IRC 2015 and IBC 2012; 100 mph IBC 2009 and IRC 2009/2012

## DESIGN ASSUMPTIONS:

1. These tables are limited to structures with a mean roof height of 30'.
2. The vertical load capacity is valid for wall columns supporting roof and floor loads. The design dead load shall not exceed design live load.
3. The vertical capacity has been reduced to allow for holes and notches. Refer to the Drilling & Notching guidelines on page 4 for more information.
4. The vertical load capacity assumes an eccentricity of 1/6 of the wall thickness.
5. The design wind pressures are based on Part 1, Chapter 30 of ASCE 7-16 for Components and Cladding: Wall Zone 4, Enclosed, Risk Category II structure with topographic factor of  $K_{zt} = 1.00$ , and importance factor of  $I = 1.00$  (when it applies).
6. A load duration adjustment,  $C_D = 1.60$ , has been applied for wind.
7. A repetitive member increase of 4% has been applied as allowed for 3 or more wall studs spaced no more than 24" oc, properly connected by a suitable exterior sheathing. No increase in stiffness has been assumed for the wall sheathing.
8. A gypsum wall board is assumed attached to the interior side of the studs.
9. The tabulated capacities assume the plates are the same material and grade as the stud except 1.35E LSL plates are used with LVL studs. For other plate material or grade a lower value may control. The designer must check the required vertical load against the bearing capacity for the plate and adjust the stud size and/or spacing accordingly.

## ADDITIONAL NOTES:

1. Height is the clear height of the wall stud between the bottom plate and the lower top plate.
2. The first value in each cell represents the allowable vertical load capacity of a single stud, in pounds per linear foot of wall length (plf). These capacities are either the allowable capacity for vertical loads acting alone (no horizontal wind pressure) or the capacity of the stud after accounting for the bending induced by the horizontal wind pressure.
3. The second value in each cell represents the deflection ratio (L/x) based on the horizontal wind pressure. The designer shall verify the correct deflection ratio limit for the intended application.
4. Install full-width blocking per local code requirements, normally no more than every 8' along the height of the stud.
5. Do not use a product where designated "-" without further analysis by a professional engineer.





# Exterior Wall Column Capacity (lbs): 130 mph IBC/IRC 2018, Exposure C

**TO USE:**

1. Select the table for 2x4 Walls or 2x6 Walls, as needed.
2. Determine the height of the column. If not listed, use the next tallest Height in the table.
3. Determine the Tributary Width of the wall associated with the horizontal wind pressure supported by the column. If not listed, use the next largest Tributary Width.
4. Select the LP® SolidStart® LSL or LVL grade and size where the Vertical Load Capacity and Deflection Ratio meet or exceed the applied vertical load and required deflection limit.
5. Verify the plate bearing capacity for the selected column. See Design Assumption 10 below.

2X4 WALLS		1.35E LP LSL				1.55E LP LSL		1.75E LP LSL	
Height	Tributary Width	Single <sup>3</sup>	Double	3-1/2" x 3-1/2" Beam or Plank	5-1/2" x 3-1/2" Plank	Single <sup>3</sup>	Double	3-1/2" x 3-1/2" Beam or Plank	5-1/2" x 3-1/2" Plank
		1-1/2" x 3-1/2"	1-1/2" x 3-1/2"	3-1/2" x 3-1/2"	5-1/2" x 3-1/2"	1-1/2" x 3-1/2"	1-1/2" x 3-1/2"	3-1/2" x 3-1/2"	5-1/2" x 3-1/2"
8'	16"	2072 L/293	2584 L/572	5355 L/510	9790 L/549	2929 L/317	3105 L/622	7173 L/557	13255 L/572
	24"	926 L/195	2262 L/391	4869 L/416	9790 L/478	2291 L/224	2844 L/449	7173 L/467	13255 L/510
	36"	-	1748 L/262	3861 L/306	9436 L/401	408 L/150	2393 L/301	6361 L/377	13255 L/440
	48"	-	-	2355 L/234	8381 L/348	-	1928 L/230	5492 L/303	13065 L/389
9'	16"	1419 L/210	2358 L/420	4801 L/422	8389 L/502	2155 L/241	2919 L/482	6743 L/469	11284 L/539
	24"	-	1932 L/280	3980 L/327	8326 L/419	1411 L/161	2635 L/322	6268 L/382	11284 L/462
	36"	-	361 L/187	2494 L/218	7124 L/335	-	1920 L/214	5137 L/282	10964 L/380
	48"	-	-	-	6026 L/261	-	-	4093 L/216	9945 L/326
10'	16"	822 L/155	2144 L/311	3962 L/352	7234 L/446	1630 L/178	2711 L/357	5932 L/402	9682 L/493
	24"	-	1634 L/207	3125 L/242	6697 L/357	-	2251 L/238	5140 L/313	9682 L/406
	36"	-	-	768 L/161	5524 L/253	-	1053 L/158	3995 L/209	8766 L/320
	48"	-	-	-	4438 L/192	-	-	2256 L/159	7765 L/250
12'	16"	-	1690 L/185	2594 L/216	5198 L/335	-	2244 L/213	4042 L/280	7311 L/390
	24"	-	487 L/123	1797 L/144	4459 L/226	-	1660 L/142	3325 L/187	6786 L/293
	36"	-	-	-	3390 L/151	-	-	2054 L/124	5788 L/195
	48"	-	-	-	-	-	-	-	4829 L/146
14'	16"	-	-	1737 L/139	3723 L/218	-	1756 L/137	2846 L/180	5468 L/283
	24"	-	-	-	3054 L/145	-	-	2199 L/120	4829 L/189
	36"	-	-	-	-	-	-	-	3936 L/126
	48"	-	-	-	-	-	-	-	-

2X6 WALLS		1.35E LP LSL			1.55E LP LSL		1.75E LP LSL		2.0E LP LVL			
Height	Tributary Width	Single <sup>3</sup>	Double	3-1/2" x 5-1/2"	Single <sup>3</sup>	Double	3-1/2" x 5-1/2"	Single <sup>3</sup>	Double	3-1/2" x 5-1/2"	5-1/2" x 3-1/2"	5-1/4" x 5-1/2"
		1-1/2" x 5-1/2"	1-1/2" x 5-1/2"	3-1/2" x 5-1/2"	1-1/2" x 5-1/2"	1-1/2" x 5-1/2"	3-1/2" x 5-1/2"	1-1/2" x 5-1/2"	1-1/2" x 5-1/2"	1-1/2" x 5-1/2"	3-1/2" x 5-1/2"	5-1/4" x 5-1/2"
8'	16"	5631 L/536	4188 L/999	9584 L/987	6372 L/514	4878 L/999	12793 L/999	5632 L/577	6215 L/999	13142 L/999	19713 L/738	
	24"	5631 L/480	4188 L/999	9584 L/880	6372 L/467	4878 L/999	12793 L/934	5632 L/534	6215 L/999	13142 L/986	19713 L/714	
	36"	5631 L/417	3880 L/959	9584 L/760	6372 L/411	4676 L/999	12793 L/825	5632 L/482	6050 L/999	13142 L/881	19713 L/683	
	48"	4804 L/372	3506 L/756	9584 L/674	6372 L/370	4321 L/868	12793 L/744	5632 L/441	5628 L/999	13142 L/802	19713 L/655	
9'	16"	5628 L/486	4172 L/999	9426 L/840	6370 L/477	4861 L/999	12589 L/883	5630 L/542	6189 L/999	13136 L/928	19705 L/680	
	24"	5628 L/421	4034 L/963	9426 L/736	6370 L/419	4818 L/999	12589 L/790	5630 L/488	6189 L/999	13136 L/840	19705 L/653	
	36"	4406 L/351	3530 L/709	9426 L/621	6370 L/354	4338 L/810	12589 L/683	5630 L/423	5643 L/972	13136 L/736	19705 L/616	
	48"	1573 L/270	3015 L/541	9240 L/543	5593 L/310	3859 L/622	12589 L/607	5630 L/378	5085 L/802	13136 L/660	19705 L/585	
10'	16"	5382 L/433	4154 L/980	9239 L/721	6367 L/434	4841 L/999	12351 L/766	5627 L/501	6159 L/999	13131 L/810	19696 L/640	
	24"	4724 L/361	3837 L/768	9239 L/620	6367 L/368	4626 L/835	12351 L/674	5627 L/435	5981 L/988	13131 L/722	19696 L/607	
	36"	2990 L/263	3227 L/526	9239 L/512	5367 L/299	4048 L/604	12351 L/571	5627 L/363	5298 L/775	13131 L/620	19696 L/563	
	48"	-	2525 L/400	8469 L/440	4110 L/230	3449 L/460	12351 L/499	5227 L/296	4600 L/593	13131 L/547	19696 L/527	
12'	16"	4017 L/333	3926 L/671	8761 L/547	5401 L/347	4698 L/729	11724 L/593	5622 L/412	6053 L/860	12974 L/636	19680 L/617	
	24"	3082 L/236	3416 L/473	8761 L/452	4574 L/271	4211 L/543	11724 L/504	5622 L/334	5475 L/677	12974 L/547	19680 L/562	
	36"	-	2577 L/315	7933 L/359	3338 L/181	3423 L/362	11724 L/411	4252 L/233	4554 L/467	12974 L/452	19680 L/495	
	48"	-	-	6821 L/276	189 L/135	1710 L/271	10813 L/347	729 L/175	3260 L/350	11946 L/385	19680 L/442	
14'	16"	2867 L/229	3594 L/458	8138 L/424	3958 L/263	4358 L/522	10887 L/472	4987 L/325	5631 L/628	12012 L/512	18782 L/575	
	24"	1813 L/152	2947 L/305	7772 L/337	3181 L/175	3739 L/351	10887 L/386	4049 L/226	4905 L/453	12012 L/424	18782 L/499	
	36"	-	612 L/203	6488 L/237	-	2687 L/234	10125 L/303	1924 L/151	3732 L/302	11191 L/337	18782 L/416	
	48"	-	-	5207 L/178	-	-	8942 L/231	-	-	9831 L/264	18332 L/357	
16'	16"	2070 L/157	3221 L/314	7019 L/341	2959 L/180	3974 L/361	9359 L/392	3767 L/232	5162 L/465	10345 L/429	15547 L/518	
	24"	-	2447 L/209	6168 L/244	2241 L/120	3228 L/240	9177 L/307	2889 L/155	4289 L/310	10199 L/340	15547 L/428	
	36"	-	-	4895 L/163	-	794 L/160	7979 L/211	-	2107 L/207	8824 L/241	15386 L/339	
	48"	-	-	3221 L/122	-	-	6813 L/158	-	-	7481 L/181	14019 L/271	
18'	16"	-	2822 L/224	5570 L/262	2246 L/129	3550 L/258	7820 L/324	2881 L/166	4640 L/332	8680 L/359	13035 L/453	
	24"	-	1633 L/149	4755 L/174	-	2696 L/172	7225 L/226	-	3637 L/221	8045 L/258	13035 L/358	
	36"	-	-	-	-	-	6111 L/151	-	-	6768 L/172	12144 L/258	
	48"	-	-	-	-	-	-	-	-	5516 L/129	10869 L/194	
20'	16"	-	2340 L/166	4422 L/194	-	3038 L/191	6463 L/251	2234 L/123	4098 L/246	7277 L/287	11066 L/388	
	24"	-	-	3631 L/129	-	1710 L/127	5702 L/167	-	3007 L/164	6447 L/191	10971 L/287	
	36"	-	-	-	-	-	-	-	-	5256 L/127	9729 L/191	
	48"	-	-	-	-	-	-	-	-	-	8547 L/143	
22'	16"	-	1719 L/126	3461 L/148	-	2426 L/145	5186 L/191	-	3558 L/188	6000 L/219	9498 L/328	
	24"	-	-	-	-	-	4434 L/127	-	2095 L/125	5224 L/146	9035 L/219	
	36"	-	-	-	-	-	-	-	-	-	7891 L/146	
	48"	-	-	-	-	-	-	-	-	-	-	

**ADDITIONAL NOTES:**

1. Height is the clear height of the column between the bottom plate and the lower top plate.
2. The first value in each cell represents the allowable vertical load capacity of the column, in pounds (lbs). These capacities are either the allowable capacity for vertical loads acting alone (no horizontal wind pressure) or the capacity of the column after accounting for the bending induced by the horizontal wind pressure.
3. The second value in each cell represents the deflection ratio (L/x) based on the horizontal wind pressure. The designer shall verify the correct deflection ratio limit for the intended application.
4. These tables are for members in the Beam orientation except for the 3-1/2" x 3-1/2" and 5-1/2" x 3-1/2" column sizes for the 2x4 wall as noted in the table. Refer to the Product Orientation detail on page 4.
5. All members shall be solid, one-piece sections except for the built-up Double (2-ply). For a 3-ply and 4-ply built-up column, multiply the Double values by 1.5 and 2.0, respectively. See page 17 for the connection of built-up columns.
6. Columns supporting a Tributary Width greater than 48" are beyond the scope of this table.
7. Do not use a product where designated "-" without further analysis by a professional engineer.

**DESIGN ASSUMPTIONS:**

1. These tables are limited to structures with a mean roof height of 30'.
2. The vertical load capacity is valid for roof columns supporting roof and floor loads. The design dead load shall not exceed design live load.
3. The vertical capacity has been reduced to allow for holes and notches. Refer to the Drilling & Notching guidelines on page 4 for more information.
4. The vertical load capacity assumes an eccentricity of 1/6 of the wall thickness.
5. These tables are based on: a wind speed of 130 mph IBC/IRC 2015 and IBC 2012; 100 mph IBC 2009 and IRC 2009/2012. The design wind pressures are based on Part 1, Chapter 30 of ASCE 7-16 for Components and Cladding; Wall Zone 4, Enclosed, Risk Category II structure with topographic factor of K<sub>zt</sub> = 1.00, and importance factor of I = 1.00 (when it applies).
6. A load duration adjustment, C<sub>D</sub> = 1.60, has been applied for wind.
7. No repetitive member increase has been applied.
8. Full-width blocking is assumed to be installed at 8' on-center or less.
9. Design for a Single 1-1/2" wall column also requires continuous, full-length lateral support through connection to the exterior wall sheathing and interior gypsum wall board.
10. The tabulated capacities assume the plates are the same material and grade as the stud except 1.35E LSL plates are used with LVL studs. For other plate material or grade a lower value may control. The designer must check the required vertical load against the bearing capacity for the plate and adjust the column size and/or spacing accordingly.

# Exterior Wall Column Capacity (lbs): 115 mph IBC/IRC 2018, Exposure B

**TO USE:**

- Determine the height of the column. If not listed, use the next tallest Height in the table.
- Determine the Tributary Width of the wall associated with the horizontal wind pressure supported by the column. If not listed, use the next largest Tributary Width.
- Select the LP® SolidStart® LSL or LVL grade and size where the Vertical Load Capacity and Deflection Ratio meet or exceed the applied vertical load and required deflection limit.
- Verify the plate bearing capacity for the selected column. See Design Assumption 10 below.

2X8 WALLS												
Height	Tributary Width	1.35E LP LSL			1.55E LP LSL		1.75E LP LSL		2.0E LP LVL			
		Single <sup>3</sup> 1-1/2" x 7-1/4"	Double 1-1/2" x 7-1/4"	3-1/2" x 7-1/4"	Single <sup>3</sup> 1-1/2" x 7-1/4"	Double 1-1/2" x 7-1/4"	3-1/2" x 7-1/4"	Single <sup>3</sup> 1-1/2" x 7-1/4"	Double 1-1/2" x 7-1/4"	3-1/2" x 7-1/4"	5-1/4" x 7-1/4"	
8'	16"	7422 L/781	5439 L/999	12842 L/999	8400 L/703	6310 L/999	17131 L/999	7424 L/692	8020 L/999	17323 L/999	25985 L/948	
	24"	7422 L/731	5439 L/999	12842 L/999	8400 L/668	6310 L/999	17131 L/999	7424 L/675	8020 L/999	17323 L/999	25985 L/937	
	36"	7422 L/669	5439 L/999	12842 L/999	8400 L/622	6310 L/999	17131 L/999	7424 L/653	8020 L/999	17323 L/999	25985 L/921	
	48"	7422 L/619	5439 L/999	12842 L/999	8400 L/584	6310 L/999	17131 L/999	7424 L/633	8020 L/999	17323 L/999	25985 L/907	
9'	16"	7419 L/674	5426 L/999	12734 L/999	8396 L/610	6295 L/999	16994 L/999	7421 L/658	7999 L/999	17316 L/999	25974 L/861	
	24"	7419 L/623	5426 L/999	12734 L/999	8396 L/579	6295 L/999	16994 L/999	7421 L/637	7999 L/999	17316 L/999	25974 L/849	
	36"	7419 L/580	5426 L/999	12734 L/999	8396 L/545	6295 L/999	16994 L/999	7421 L/608	7999 L/999	17316 L/999	25974 L/831	
	48"	7419 L/545	5426 L/999	12734 L/999	8396 L/517	6295 L/999	16994 L/999	7421 L/583	7999 L/999	17316 L/999	25974 L/815	
10'	16"	7416 L/614	5412 L/999	12607 L/999	8393 L/577	6279 L/999	16835 L/999	7418 L/634	7974 L/999	17309 L/999	25963 L/795	
	24"	7416 L/575	5412 L/999	12607 L/999	8393 L/546	6279 L/999	16835 L/999	7418 L/606	7974 L/999	17309 L/999	25963 L/781	
	36"	7416 L/525	5412 L/999	12607 L/999	8393 L/504	6279 L/999	16835 L/999	7418 L/569	7974 L/999	17309 L/999	25963 L/760	
	48"	7416 L/485	5398 L/999	12607 L/925	8393 L/471	6279 L/999	16835 L/983	7418 L/537	7974 L/999	17309 L/999	25963 L/742	
12'	16"	7409 L/552	5377 L/999	12300 L/948	8386 L/536	6239 L/999	16437 L/974	7412 L/596	7915 L/999	17294 L/999	25942 L/705	
	24"	7409 L/497	5377 L/999	12300 L/866	8386 L/489	6239 L/999	16437 L/905	7412 L/552	7915 L/999	17294 L/947	25942 L/686	
	36"	7409 L/432	5377 L/999	12300 L/767	8386 L/431	6239 L/999	16437 L/819	7412 L/497	7915 L/999	17294 L/865	25942 L/660	
	48"	7409 L/382	5045 L/897	12300 L/688	8386 L/386	6030 L/975	16437 L/747	7412 L/452	7752 L/999	17294 L/796	25942 L/635	
14'	16"	6612 L/493	5333 L/999	11898 L/782	8189 L/493	6189 L/999	15914 L/812	7405 L/555	7840 L/999	17280 L/850	25920 L/676	
	24"	6612 L/423	5333 L/979	11898 L/697	8189 L/430	6189 L/999	15914 L/740	7405 L/494	7840 L/999	17280 L/781	25920 L/648	
	36"	6612 L/349	5088 L/770	11898 L/600	8189 L/360	6060 L/838	15914 L/652	7405 L/424	7774 L/989	17280 L/697	25920 L/611	
	48"	6144 L/297	4665 L/610	11898 L/526	8189 L/310	5646 L/697	15914 L/583	7405 L/371	7289 L/837	17280 L/629	25920 L/577	
16'	16"	5706 L/432	5277 L/937	11393 L/659	6968 L/443	6125 L/999	15246 L/694	7399 L/508	7747 L/999	16864 L/732	25898 L/676	
	24"	5706 L/354	5267 L/747	11393 L/573	6968 L/369	6125 L/809	15246 L/619	7399 L/433	7747 L/947	16864 L/659	25898 L/654	
	36"	5404 L/278	4777 L/560	11393 L/480	6968 L/295	5739 L/629	15246 L/532	7399 L/354	7384 L/754	16864 L/573	25898 L/631	
	48"	4665 L/210	4247 L/420	11393 L/413	6517 L/241	5235 L/482	15246 L/466	7399 L/299	6806 L/622	16864 L/507	25898 L/535	
18'	16"	4916 L/372	5208 L/746	10777 L/564	5951 L/389	6046 L/803	14424 L/604	7261 L/453	7633 L/927	15914 L/642	25359 L/667	
	24"	4829 L/292	4906 L/583	10777 L/479	5951 L/311	5859 L/636	14424 L/525	7261 L/370	7613 L/751	15914 L/564	25359 L/610	
	36"	4040 L/200	4241 L/400	10777 L/390	5538 L/230	5209 L/460	14424 L/440	7177 L/289	6950 L/584	15914 L/478	25359 L/540	
	48"	3255 L/150	3534 L/300	10777 L/329	4848 L/172	4528 L/345	14424 L/379	6444 L/222	6264 L/445	15914 L/414	25359 L/485	
20'	16"	4255 L/316	5005 L/605	9894 L/497	5118 L/337	5937 L/656	13219 L/541	6278 L/396	7493 L/763	14580 L/578	21935 L/649	
	24"	3779 L/222	4462 L/445	9894 L/410	4979 L/255	5402 L/509	13219 L/459	6278 L/311	7237 L/604	14580 L/494	21935 L/576	
	36"	2968 L/148	3618 L/296	9894 L/324	4262 L/170	4578 L/340	13219 L/373	5842 L/219	6478 L/439	14580 L/406	21935 L/493	
	48"	-	2252 L/222	9236 L/259	3561 L/127	3714 L/255	13219 L/314	5144 L/164	5690 L/329	14580 L/344	21935 L/430	
22'	16"	3511 L/254	4626 L/497	8626 L/448	4438 L/287	5535 L/543	11481 L/500	5467 L/342	7323 L/635	12707 L/536	19108 L/621	
	24"	2947 L/169	3964 L/339	8626 L/357	3988 L/195	4885 L/390	11481 L/410	5467 L/251	6835 L/493	12707 L/443	19108 L/534	
	36"	-	2933 L/226	8182 L/264	3266 L/130	3880 L/260	11481 L/322	4712 L/167	5895 L/335	12707 L/351	19108 L/442	
	48"	-	-	7320 L/198	-	2014 L/195	11026 L/257	3959 L/125	4877 L/251	12707 L/291	19108 L/376	
24'	16"	2850 L/199	4204 L/398	7566 L/399	3709 L/228	5089 L/454	10046 L/456	4797 L/294	7023 L/534	11152 L/490	16772 L/585	
	24"	2288 L/132	3421 L/265	7566 L/308	3204 L/152	4317 L/305	10046 L/361	4479 L/196	6259 L/393	11152 L/392	16772 L/488	
	36"	-	1351 L/177	6660 L/206	-	3132 L/203	9825 L/268	3704 L/131	5086 L/262	11152 L/302	16772 L/391	
	48"	-	-	5789 L/155	-	-	8989 L/201	-	3698 L/196	10847 L/229	16772 L/326	
26'	16"	2319 L/159	3753 L/318	6685 L/352	3074 L/182	4604 L/365	8857 L/410	4208 L/235	6477 L/456	9854 L/442	14814 L/545	
	24"	-	2861 L/212	6325 L/247	2574 L/121	3721 L/243	8857 L/316	3668 L/157	5575 L/314	9854 L/345	14814 L/441	
	36"	-	-	5424 L/165	-	1444 L/162	8184 L/214	-	4241 L/209	9802 L/244	14814 L/345	
	48"	-	-	4557 L/123	-	-	7356 L/160	-	1262 L/157	8956 L/183	14814 L/275	
28'	16"	1880 L/128	3279 L/257	5939 L/300	2554 L/147	4090 L/295	7859 L/365	3539 L/190	5870 L/381	8765 L/396	13172 L/500	
	24"	-	2150 L/171	5304 L/200	-	3106 L/197	7700 L/259	3001 L/127	4870 L/254	8765 L/296	13172 L/396	
	36"	-	-	4404 L/133	-	-	6835 L/173	-	3134 L/169	8245 L/197	13172 L/296	
	48"	-	-	-	-	-	6013 L/129	-	-	7409 L/148	12897 L/222	
30'	16"	-	2779 L/211	5090 L/246	2127 L/121	3535 L/243	7017 L/320	2985 L/156	5186 L/313	7841 L/353	11782 L/456	
	24"	-	927 L/141	4460 L/164	-	2413 L/162	6580 L/213	-	4118 L/209	7840 L/243	11782 L/353	
	36"	-	-	-	-	-	5723 L/142	-	1307 L/139	6962 L/162	11782 L/243	
	48"	-	-	-	-	-	-	-	-	6136 L/121	10964 L/182	

**DESIGN ASSUMPTIONS:**

- These tables are limited to structures with a mean roof height of 30'.
- The vertical load capacity is valid for wall columns supporting roof and floor loads. The design dead load shall not exceed design live load.
- The vertical capacity has been reduced to allow for holes and notches. Refer to the Drilling & Notching guidelines on page 4 for more information.
- The vertical load capacity assumes an eccentricity of 1/6 of the wall thickness.
- These tables are based on: a wind speed of 115 mph IBC/IRC 2015 and IBC 2012; 90 mph IBC 2009 and IRC 2009/2012. The design wind pressures are based on Part 1, Chapter 30 of ASCE 7-16 for Components and Cladding; Wall Zone 4, Enclosed, Risk Category II structure with topographic factor of  $K_{zt} = 1.00$ , and importance factor of  $I = 1.00$  (when it applies).
- A load duration adjustment,  $C_D = 1.60$ , has been applied for wind.
- No repetitive member increase has been applied.
- Full-width blocking is assumed to be installed at 8' on-center or less.
- Design for a Single 1-1/2" wall column also requires continuous, full-length lateral support through connection to the exterior wall sheathing and interior gypsum wall board.
- The tabulated capacities assume the plates are the same material and grade as the stud except 1.35E LSL plates are used with LVL studs. For other plate material or grade a lower value may control. The designer must check the required vertical load against the bearing capacity for the plate and adjust the column size and/or spacing accordingly.

**ADDITIONAL NOTES:**

- Height is the clear height of the column between the bottom plate and the lower top plate.
- The first value in each cell represents the allowable vertical load capacity of the column, in pounds (lbs). These capacities are either the allowable capacity for vertical loads acting alone (no horizontal wind pressure) or the capacity of the column after accounting for the bending induced by the horizontal wind pressure.
- The second value in each cell represents the deflection ratio (L/x) based on the horizontal wind pressure. The designer shall verify the correct deflection ratio limit for the intended application.
- This table is for members in Beam Orientation only.
- All members shall be solid, one-piece sections except for the built-up Double (2-ply). For a 3-ply and 4-ply built-up column, multiply the Double values by 1.5 and 2.0, respectively. See page 17 for the connection of built-up columns.
- Columns supporting a Tributary Width greater than 48" are beyond the scope of this table.
- Do not use a product where designated "-" without further analysis by a professional engineer.



# Exterior Wall Column Capacity (lbs): 130 mph IBC/IRC 2018, Exposure C

**TO USE:**

1. Determine the height of the column. If not listed, use the next tallest Height in the table.
2. Determine the Tributary Width of the wall associated with the horizontal wind pressure supported by the column. If not listed, use the next largest Tributary Width.
3. Select the LP® SolidStart® LSL or LVL grade and size where the Vertical Load Capacity and Deflection Ratio meet or exceed the applied vertical load and required deflection limit.
4. Verify the plate bearing capacity for the selected column. See Design Assumption 10 below.

2X8 WALLS												
Height	Tributary Width	1.35E LP LSL			1.55E LP LSL			1.75E LP LSL	2.0E LP LVL			
		Single <sup>3</sup> 1-1/2" x 7-1/4"	Double 1-1/2" x 7-1/4"	3-1/2" x 7-1/4"	Single <sup>3</sup> 1-1/2" x 7-1/4"	Double 1-1/2" x 7-1/4"	3-1/2" x 7-1/4"	Single <sup>3</sup> 1-1/2" x 7-1/4"	Double 1-1/2" x 7-1/4"	3-1/2" x 7-1/4"	5-1/4" x 7-1/4"	
8'	16"	7422 L/707	5439 L/999	12842 L/999	8400 L/650	6310 L/999	17131 L/999	7424 L/667	8020 L/999	17323 L/999	25985 L/931	
	24"	7422 L/638	5439 L/999	12842 L/999	8400 L/598	6310 L/999	17131 L/999	7424 L/640	8020 L/999	17323 L/999	25985 L/912	
	36"	7422 L/571	5439 L/999	12842 L/999	8400 L/538	6310 L/999	17131 L/999	7424 L/605	8020 L/999	17323 L/999	25985 L/886	
	48"	7422 L/530	5237 L/999	12842 L/999	8400 L/505	6232 L/999	17131 L/999	7424 L/576	8010 L/999	17323 L/999	25985 L/863	
9'	16"	7419 L/606	5426 L/999	12734 L/999	8396 L/566	6295 L/999	16994 L/999	7421 L/626	7999 L/999	17316 L/999	25974 L/842	
	24"	7419 L/559	5426 L/999	12734 L/999	8396 L/529	6295 L/999	16994 L/999	7421 L/593	7999 L/999	17316 L/999	25974 L/822	
	36"	7419 L/501	5261 L/999	12734 L/986	8396 L/481	6253 L/999	16994 L/999	7421 L/550	7999 L/999	17316 L/999	25974 L/793	
	48"	7419 L/457	4884 L/999	12734 L/890	8396 L/444	5888 L/999	16994 L/968	7421 L/516	7600 L/999	17316 L/999	25974 L/768	
10'	16"	7416 L/556	5412 L/999	12607 L/999	8393 L/530	6279 L/999	16835 L/999	7418 L/592	7974 L/999	17309 L/999	25963 L/773	
	24"	7416 L/502	5412 L/999	12607 L/957	8393 L/485	6279 L/999	16835 L/999	7418 L/550	7974 L/999	17309 L/999	25963 L/750	
	36"	7416 L/437	5044 L/999	12607 L/831	8393 L/430	6038 L/999	16835 L/899	7418 L/498	7773 L/999	17309 L/956	25963 L/718	
	48"	7416 L/390	4576 L/897	12607 L/740	8393 L/388	5590 L/999	16835 L/814	7418 L/457	7246 L/999	17309 L/872	25963 L/690	
12'	16"	7409 L/472	5377 L/999	12300 L/828	8386 L/467	6239 L/999	16437 L/872	7412 L/531	7915 L/999	17294 L/916	25942 L/677	
	24"	7409 L/403	5201 L/968	12300 L/723	8386 L/406	6182 L/999	16437 L/779	7412 L/471	7915 L/999	17294 L/827	25942 L/647	
	36"	7110 L/332	4584 L/711	12300 L/607	8386 L/340	5586 L/815	16437 L/671	7412 L/404	7230 L/979	17294 L/722	25942 L/606	
	48"	5767 L/266	3915 L/533	12300 L/523	8386 L/292	4952 L/612	16437 L/589	7412 L/353	6494 L/790	17294 L/640	25942 L/570	
14'	16"	6612 L/394	5333 L/894	11898 L/659	8189 L/402	6189 L/964	15914 L/707	7405 L/467	7840 L/999	17280 L/749	25920 L/635	
	24"	6498 L/319	4867 L/692	11898 L/559	8189 L/332	5841 L/757	15914 L/614	7405 L/394	7521 L/903	17280 L/659	25920 L/592	
	36"	5173 L/230	4084 L/461	11898 L/455	7514 L/263	5092 L/529	15914 L/513	7405 L/319	6644 L/683	17280 L/558	25920 L/539	
	48"	3300 L/173	3069 L/346	11804 L/383	6341 L/198	4272 L/397	15914 L/441	7405 L/256	5695 L/512	17280 L/484	25920 L/494	
16'	16"	5706 L/323	5095 L/674	11393 L/536	6968 L/339	6054 L/734	15246 L/585	7399 L/401	7747 L/868	16864 L/626	25898 L/614	
	24"	5012 L/237	4495 L/475	11393 L/441	6815 L/266	5476 L/546	15246 L/495	7399 L/322	7079 L/681	16864 L/536	25898 L/556	
	36"	3682 L/158	3502 L/317	11393 L/349	5657 L/182	4527 L/364	15246 L/402	7152 L/234	6010 L/469	16864 L/441	25898 L/486	
	48"	-	73 L/237	10513 L/277	4497 L/136	3040 L/273	15246 L/338	5802 L/176	4853 L/352	16864 L/374	25898 L/432	
18'	16"	4550 L/255	4676 L/511	10777 L/443	5951 L/281	5629 L/573	14424 L/492	7261 L/337	7379 L/682	15914 L/531	25359 L/583	
	24"	3627 L/170	3873 L/340	10777 L/356	5169 L/195	4855 L/391	14424 L/406	6788 L/252	6590 L/504	15914 L/442	25359 L/509	
	36"	-	1310 L/227	9967 L/264	3966 L/130	3587 L/260	14424 L/321	5501 L/168	5334 L/336	15914 L/353	25359 L/428	
	48"	-	-	8675 L/198	-	-	13549 L/257	4215 L/126	2977 L/252	15449 L/294	25359 L/369	
20'	16"	3495 L/189	4177 L/379	9894 L/375	4728 L/217	5120 L/435	13219 L/425	6278 L/280	6978 L/545	14580 L/459	21935 L/544	
	24"	2545 L/126	3158 L/252	9645 L/292	3892 L/145	4137 L/290	13219 L/340	5477 L/187	6065 L/374	14580 L/371	21935 L/458	
	36"	-	-	8164 L/196	-	495 L/193	12554 L/255	4263 L/124	4631 L/249	14580 L/288	21935 L/370	
	48"	-	-	6713 L/147	-	-	11184 L/191	-	-	13369 L/218	21935 L/310	
22'	16"	2660 L/144	3612 L/289	8626 L/323	3734 L/166	4535 L/332	11481 L/374	5213 L/214	6537 L/428	12707 L/406	19108 L/498	
	24"	-	1488 L/192	7729 L/225	-	3331 L/221	11421 L/289	4315 L/142	5367 L/285	12707 L/317	19108 L/405	
	36"	-	-	6230 L/150	-	-	9989 L/194	-	2098 L/190	12144 L/222	19108 L/316	
	48"	-	-	-	-	-	8612 L/145	-	-	10745 L/166	19052 L/250	
24'	16"	-	3004 L/226	7240 L/263	2945 L/129	3905 L/259	10046 L/326	4202 L/167	5848 L/335	11152 L/355	16772 L/449	
	24"	-	-	6198 L/175	-	1382 L/173	9381 L/228	-	4454 L/223	11152 L/260	16772 L/354	
	36"	-	-	-	-	-	7954 L/152	-	-	9793 L/173	16772 L/260	
	48"	-	-	-	-	-	-	-	-	8402 L/130	15552 L/195	
26'	16"	-	2120 L/179	5997 L/209	-	3241 L/206	8733 L/272	3387 L/133	5100 L/266	9854 L/309	14814 L/401	
	24"	-	-	4953 L/139	-	-	7733 L/181	-	3083 L/177	9342 L/207	14814 L/308	
	36"	-	-	-	-	-	6312 L/120	-	-	7900 L/138	14136 L/207	
	48"	-	-	-	-	-	-	-	-	-	12706 L/155	
28'	16"	-	697 L/146	4982 L/170	-	2358 L/167	7390 L/221	-	4349 L/216	8765 L/252	13172 L/357	
	24"	-	-	-	-	-	6400 L/147	-	934 L/144	7800 L/168	13172 L/252	
	36"	-	-	-	-	-	-	-	-	-	11820 L/168	
	48"	-	-	-	-	-	-	-	-	-	10398 L/126	
30'	16"	-	-	4140 L/139	-	920 L/137	6269 L/181	-	3551 L/177	7521 L/207	11782 L/310	
	24"	-	-	-	-	-	5288 L/120	-	-	6521 L/138	11365 L/207	
	36"	-	-	-	-	-	-	-	-	-	9884 L/138	
	48"	-	-	-	-	-	-	-	-	-	-	

**DESIGN ASSUMPTIONS:**

1. These tables are limited to structures with a mean roof height of 30'.
2. The vertical load capacity is valid for wall columns supporting roof and floor loads. The design dead load shall not exceed design live load.
3. The vertical capacity has been reduced to allow for holes and notches. Refer to the Drilling & Notching guidelines on page 4 for more information.
4. The vertical load capacity assumes an eccentricity of 1/6 of the wall thickness.
5. These tables are based on: a wind speed of 130 mph IBC/IRC 2015 and IBC 2012; 100 mph IBC 2009 and IRC 2009/2012. The design wind pressures are based on Part 1, Chapter 30 of ASCE 7-16 for Components and Cladding; Wall Zone 4, Enclosed, Risk Category II structure with topographic factor of  $K_{zt} = 1.00$ , and importance factor of  $I = 1.00$  (when it applies).
6. A load duration adjustment,  $C_D = 1.60$ , has been applied for wind.
7. No repetitive member increase has been applied.
8. Full-width blocking is assumed to be installed at 8' on-center or less.
9. Design for a Single 1-1/2" wall column also requires continuous, full-length lateral support through connection to the exterior wall sheathing and interior gypsum wall board.
10. The tabulated capacities assume the plates are the same material and grade as the stud except 1.35E LSL plates are used with LVL studs. For other plate material or grade a lower value may control. The designer must check the required vertical load against the bearing capacity for the plate and adjust the column size and/or spacing accordingly.

**ADDITIONAL NOTES:**

1. Height is the clear height of the column between the bottom plate and the lower top plate.
2. The first value in each cell represents the allowable vertical load capacity of the column, in pounds (lbs). These capacities are either the allowable capacity for vertical loads acting alone (no horizontal wind pressure) or the capacity of the column after accounting for the bending induced by the horizontal wind pressure.
3. The second value in each cell represents the deflection ratio (L/x) based on the horizontal wind pressure. The designer shall verify the correct deflection ratio limit for the intended application.
4. This table is for members in Beam Orientation only.
5. All members shall be solid, one-piece sections except for the built-up Double (2-ply). For a 3-ply and 4-ply built-up column, multiply the Double values by 1.5 and 2.0, respectively. See page 17 for the connection of built-up columns.
6. Columns supporting a Tributary Width greater than 48" are beyond the scope of this table.
7. Do not use a product where designated "-" without further analysis by a professional engineer.

# Exterior Wall Column Capacity (lbs): 115 mph IBC/IRC 2018, Exposure B

## TO USE:

- Determine the height of the column. If not listed, use the next tallest Height in the table.
- Determine the Tributary Width of the wall associated with the horizontal wind pressure supported by the column. If not listed, use the next largest Tributary Width.
- Select the LP® SolidStart® LSL or LVL grade and size where the Vertical Load Capacity and Deflection Ratio meet or exceed the applied vertical load and required deflection limit.
- Verify the plate bearing capacity for the selected column. See Design Assumption 10 below.

2X10 WALLS															
Height	Tributary Width	1.55E LP LSL					2.0E LP LVL								
		Single <sup>3</sup> 1-1/2" x 9-1/4"	Double 1-1/2" x 9-1/4"	3-1/2" x 9-1/4"	Single <sup>3</sup> 1-1/2" x 9-1/4"	Double 1-1/2" x 9-1/4"	3-1/2" x 9-1/4"	5-1/4" x 9-1/4"							
8'	16"	10717	L/890	7802	L/999	19678	L/999	9472	L/807	9867	L/999	22102	L/999	33154	L/999
	24"	10717	L/861	7802	L/999	19678	L/999	9472	L/795	9867	L/999	22102	L/999	33154	L/999
	36"	10717	L/822	7802	L/999	19678	L/999	9472	L/778	9867	L/999	22102	L/999	33154	L/999
	48"	10717	L/787	7802	L/999	19678	L/999	9472	L/763	9867	L/999	22102	L/999	33154	L/999
9'	16"	10713	L/780	7789	L/999	19590	L/999	9468	L/749	9848	L/999	22093	L/999	33140	L/999
	24"	10713	L/750	7789	L/999	19590	L/999	9468	L/735	9848	L/999	22093	L/999	33140	L/999
	36"	10713	L/708	7789	L/999	19590	L/999	9468	L/715	9848	L/999	22093	L/999	33140	L/999
	48"	10713	L/673	7789	L/999	19590	L/999	9468	L/697	9848	L/999	22093	L/999	33140	L/999
10'	16"	10708	L/691	7774	L/999	19490	L/999	9464	L/705	9826	L/999	22084	L/999	33126	L/973
	24"	10708	L/659	7774	L/999	19490	L/999	9464	L/688	9826	L/999	22084	L/999	33126	L/962
	36"	10708	L/617	7774	L/999	19490	L/999	9464	L/664	9826	L/999	22084	L/999	33126	L/946
	48"	10708	L/582	7774	L/999	19490	L/999	9464	L/643	9826	L/999	22084	L/999	33126	L/931
12'	16"	10699	L/594	7739	L/999	19245	L/999	9456	L/650	9774	L/999	22065	L/999	33098	L/839
	24"	10699	L/565	7739	L/999	19245	L/999	9456	L/624	9774	L/999	22065	L/999	33098	L/825
	36"	10699	L/527	7739	L/999	19245	L/999	9456	L/590	9774	L/999	22065	L/999	33098	L/806
	48"	10699	L/493	7739	L/999	19245	L/999	9456	L/558	9774	L/999	22065	L/999	33098	L/787
14'	16"	10691	L/557	7696	L/999	18934	L/999	9448	L/615	9711	L/999	22047	L/999	33070	L/751
	24"	10691	L/517	7696	L/999	18934	L/988	9448	L/578	9711	L/999	22047	L/999	33070	L/734
	36"	10691	L/466	7696	L/999	18934	L/897	9448	L/530	9711	L/999	22047	L/981	33070	L/710
	48"	10691	L/424	7578	L/999	18934	L/821	9448	L/489	9663	L/999	22047	L/912	33070	L/687
16'	16"	10682	L/526	7644	L/999	18544	L/905	9440	L/586	9636	L/999	22028	L/970	33043	L/693
	24"	10682	L/473	7644	L/999	18544	L/830	9440	L/536	9636	L/999	22028	L/904	33043	L/672
	36"	10682	L/411	7581	L/999	18544	L/739	9440	L/474	9636	L/999	22028	L/820	33043	L/642
	48"	10682	L/365	7089	L/926	18544	L/666	9440	L/426	9271	L/999	22028	L/750	33043	L/615
18'	16"	10261	L/492	7582	L/999	18064	L/784	9432	L/553	9546	L/999	22010	L/849	33015	L/681
	24"	10261	L/429	7582	L/999	18064	L/707	9432	L/490	9546	L/999	22010	L/779	33015	L/652
	36"	10261	L/360	7103	L/865	18064	L/618	9432	L/418	9425	L/999	22010	L/694	33015	L/612
	48"	10261	L/310	6455	L/709	18064	L/549	9432	L/364	8840	L/855	22010	L/625	33015	L/577
20'	16"	9047	L/457	7509	L/999	17480	L/690	9424	L/516	9442	L/999	21497	L/755	32987	L/680
	24"	9047	L/385	7330	L/887	17480	L/613	9424	L/442	9442	L/999	21497	L/681	32987	L/640
	36"	9047	L/311	6548	L/695	17480	L/525	9424	L/363	9056	L/816	21497	L/594	32987	L/588
	48"	8667	L/261	5714	L/526	17480	L/459	9424	L/309	8382	L/679	21497	L/527	32987	L/544
22'	16"	7990	L/417	7423	L/918	16787	L/616	9417	L/475	9320	L/999	20595	L/678	32959	L/675
	24"	7990	L/340	6888	L/735	16787	L/537	9417	L/394	9320	L/850	20595	L/602	32959	L/623
	36"	7764	L/265	5910	L/536	16787	L/451	9417	L/313	8519	L/669	20595	L/514	32959	L/559
	48"	6901	L/201	4870	L/402	16787	L/389	9417	L/259	7532	L/519	20595	L/449	32959	L/506
24'	16"	7083	L/376	7141	L/782	15985	L/556	8658	L/432	9180	L/892	19572	L/617	30228	L/665
	24"	7083	L/297	6389	L/615	15985	L/476	8658	L/348	8942	L/718	19572	L/537	30228	L/601
	36"	6344	L/210	5206	L/420	15985	L/391	8658	L/270	7792	L/542	19572	L/449	30228	L/525
	48"	5461	L/157	3302	L/315	15985	L/332	7859	L/203	6577	L/406	19572	L/386	30228	L/466
26'	16"	6310	L/336	6729	L/672	14629	L/516	7742	L/390	9019	L/772	17958	L/576	27037	L/649
	24"	6087	L/251	5836	L/503	14629	L/431	7742	L/307	8345	L/613	17958	L/490	27037	L/573
	36"	5175	L/167	4433	L/335	14629	L/346	7304	L/216	6980	L/433	17958	L/401	27037	L/488
	48"	4291	L/125	240	L/251	14495	L/288	6364	L/162	5549	L/324	17958	L/340	27037	L/424
28'	16"	5647	L/297	6269	L/580	13102	L/482	6954	L/351	8718	L/673	16134	L/543	24294	L/627
	24"	5118	L/203	5233	L/407	13102	L/392	6954	L/263	7690	L/526	16134	L/450	24294	L/541
	36"	4205	L/135	2945	L/271	13102	L/306	6060	L/175	6101	L/350	16134	L/360	24294	L/448
	48"	-	-	-	-	12269	L/237	5111	L/131	3140	L/263	16134	L/300	24294	L/385
30'	16"	4948	L/251	5771	L/502	11789	L/446	6277	L/313	8159	L/590	14558	L/507	21921	L/600
	24"	4309	L/167	4590	L/335	11789	L/354	6003	L/216	6989	L/432	14558	L/413	21921	L/505
	36"	-	-	614	L/223	11420	L/260	5021	L/144	5177	L/288	14558	L/322	21921	L/411
	48"	-	-	-	-	10406	L/195	-	-	-	-	14383	L/252	21921	L/346

## DESIGN ASSUMPTIONS:

- These tables are limited to structures with a mean roof height of 30'.
- The vertical load capacity is valid for wall columns supporting roof and floor loads. The design dead load shall not exceed design live load.
- The vertical capacity has been reduced to allow for holes and notches. Refer to the Drilling & Notching guidelines on page 4 for more information.
- The vertical load capacity assumes an eccentricity of 1/6 of the wall thickness.
- These tables are based on: a wind speed of 115 mph IBC/IRC 2015 and IBC 2012, 90 mph IBC 2009 and IRC 2009/2012. The design wind pressures are based on Part 1, Chapter 30 of ASCE 7-16 for Components and Cladding: Wall Zone 4, Enclosed, Risk Category II structure with topographic factor of  $K_{zt} = 1.00$ , and importance factor of  $I = 1.00$  (when it applies).
- A load duration adjustment,  $C_D = 1.60$ , has been applied for wind.
- No repetitive member increase has been applied.
- Full-width blocking is assumed to be installed at 8' on-center or less.
- Design for a Single 1-1/2" wall column also requires continuous, full-length lateral support through connection to the exterior wall sheathing and interior gypsum wall board.
- The tabulated capacities assume the plates are the same material and grade as the stud except 1.35E LSL plates are used with LVL studs. For other plate material or grade a lower value may control. The designer must check the required vertical load against the bearing capacity for the plate and adjust the column size and/or spacing accordingly.

## ADDITIONAL NOTES:

- Height is the clear height of the column between the bottom plate and the lower top plate.
- The first value in each cell represents the allowable vertical load capacity of the column, in pounds (lbs). These capacities are either the allowable capacity for vertical loads acting alone (no horizontal wind pressure) or the capacity of the column after accounting for the bending induced by the horizontal wind pressure.
- The second value in each cell represents the deflection ratio (L/x) based on the horizontal wind pressure. The designer shall verify the correct deflection ratio limit for the intended application.
- This table is for members in Beam Orientation only.
- All members shall be solid, one-piece sections except for the built-up Double (2-ply). For a 3-ply and 4-ply built-up column, multiply the Double values by 1.5 and 2.0, respectively. See page 17 for the connection of built-up columns.
- Columns supporting a Tributary Width greater than 48" are beyond the scope of this table.
- Do not use a product where designated "-" without further analysis by a professional engineer.

# Exterior Wall Column Capacity (lbs): 130 mph IBC/IRC 2018, Exposure C

## TO USE:

- Determine the height of the column. If not listed, use the next tallest Height in the table.
- Determine the Tributary Width of the wall associated with the horizontal wind pressure supported by the column. If not listed, use the next largest Tributary Width.
- Select the LP® SolidStart® LSL or LVL grade and size where the Vertical Load Capacity and Deflection Ratio meet or exceed the applied vertical load and required deflection limit.
- Verify the plate bearing capacity for the selected column. See Design Assumption 10 below.

2X10 WALLS										
Height	Tributary Width	1.55E LP LSL					2.0E LP LVL			
		Single <sup>3</sup> 1-1/2" x 9-1/4"	Double 1-1/2" x 9-1/4"	3-1/2" x 9-1/4"	Single <sup>3</sup> 1-1/2" x 9-1/4"	Double 1-1/2" x 9-1/4"	3-1/2" x 9-1/4"	5-1/4" x 9-1/4"		
8'	16"	10717 L/846	7802 L/999	19678 L/999	9472 L/789	9867 L/999	22102 L/999	33154 L/999		
	24"	10717 L/800	7802 L/999	19678 L/999	9472 L/769	9867 L/999	22102 L/999	33154 L/999		
	36"	10717 L/742	7802 L/999	19678 L/999	9472 L/742	9867 L/999	22102 L/999	33154 L/999		
	48"	10717 L/694	7802 L/999	19678 L/999	9472 L/719	9867 L/999	22102 L/999	33154 L/999		
9'	16"	10713 L/734	7789 L/999	19590 L/999	9468 L/728	9848 L/999	22093 L/999	33140 L/999		
	24"	10713 L/688	7789 L/999	19590 L/999	9468 L/705	9848 L/999	22093 L/999	33140 L/999		
	36"	10713 L/628	7789 L/999	19590 L/999	9468 L/673	9848 L/999	22093 L/999	33140 L/999		
	48"	10713 L/581	7748 L/999	19590 L/999	9468 L/647	9848 L/999	22093 L/999	33140 L/988		
10'	16"	10708 L/644	7774 L/999	19490 L/999	9464 L/680	9826 L/999	22084 L/999	33126 L/956		
	24"	10708 L/597	7774 L/999	19490 L/999	9464 L/652	9826 L/999	22084 L/999	33126 L/937		
	36"	10708 L/548	7774 L/999	19490 L/999	9464 L/615	9826 L/999	22084 L/999	33126 L/910		
	48"	10708 L/514	7494 L/999	19490 L/999	9464 L/584	9587 L/999	22084 L/999	33126 L/887		
12'	16"	10699 L/551	7739 L/999	19245 L/999	9456 L/611	9774 L/999	22065 L/999	33098 L/818		
	24"	10699 L/508	7739 L/999	19245 L/999	9456 L/572	9774 L/999	22065 L/999	33098 L/796		
	36"	10699 L/456	7506 L/999	19245 L/949	9456 L/523	9592 L/999	22065 L/999	33098 L/764		
	48"	10699 L/413	6962 L/999	19245 L/854	9456 L/481	8956 L/999	22065 L/962	33098 L/734		
14'	16"	10691 L/498	7696 L/999	18934 L/954	9448 L/560	9711 L/999	22047 L/999	33070 L/726		
	24"	10691 L/443	7696 L/999	18934 L/855	9448 L/508	9711 L/999	22047 L/943	33070 L/698		
	36"	10691 L/380	7095 L/999	18934 L/741	9448 L/445	9106 L/999	22047 L/835	33070 L/660		
	48"	10691 L/333	6409 L/811	18934 L/653	9448 L/396	8306 L/999	22047 L/749	33070 L/626		
16'	16"	10682 L/449	7644 L/999	18544 L/795	9440 L/512	9636 L/999	22028 L/872	33043 L/661		
	24"	10682 L/385	7318 L/999	18544 L/698	9440 L/447	9505 L/999	22028 L/781	33043 L/627		
	36"	10682 L/317	6416 L/746	18544 L/590	9440 L/376	8591 L/925	22028 L/675	33043 L/583		
	48"	10682 L/270	5426 L/559	18544 L/512	9440 L/324	7632 L/722	22028 L/595	33043 L/544		
18'	16"	10261 L/402	7506 L/995	18064 L/673	9432 L/462	9546 L/999	22010 L/747	33015 L/637		
	24"	10261 L/332	6765 L/782	18064 L/580	9432 L/388	9118 L/923	22010 L/655	33015 L/593		
	36"	9813 L/263	5561 L/535	18064 L/480	9432 L/313	8052 L/691	22010 L/554	33015 L/537		
	48"	8417 L/200	3294 L/401	18064 L/409	9432 L/259	6902 L/518	22010 L/479	33015 L/490		
20'	16"	9047 L/355	7064 L/809	17480 L/579	9424 L/411	9442 L/940	21497 L/648	32987 L/621		
	24"	9047 L/282	6115 L/597	17480 L/488	9424 L/333	8708 L/738	21497 L/557	32987 L/564		
	36"	7601 L/199	4553 L/398	17480 L/395	9424 L/257	7299 L/514	21497 L/460	32987 L/496		
	48"	6138 L/149	-	17480 L/332	9272 L/192	5369 L/385	21497 L/392	32987 L/442		
22'	16"	7990 L/309	6554 L/665	16787 L/504	9417 L/361	9145 L/775	20595 L/568	32959 L/599		
	24"	7309 L/228	5376 L/456	16787 L/416	9417 L/284	8010 L/589	20595 L/478	32959 L/530		
	36"	5797 L/152	1064 L/304	16787 L/330	8526 L/196	6167 L/392	20595 L/386	32959 L/451		
	48"	-	-	15835 L/266	6949 L/147	155 L/294	20595 L/324	32959 L/393		
24'	16"	6924 L/267	5978 L/536	15985 L/442	8658 L/316	8543 L/652	19572 L/502	30228 L/572		
	24"	5878 L/178	4542 L/357	15985 L/358	8298 L/230	7159 L/461	19572 L/413	30228 L/492		
	36"	-	-	15471 L/277	6676 L/153	3714 L/307	19572 L/328	30228 L/406		
	48"	-	-	13893 L/208	-	-	19409 L/268	30228 L/347		
26'	16"	5755 L/213	5345 L/427	14629 L/396	7742 L/275	7866 L/550	17958 L/453	27037 L/539		
	24"	4698 L/142	2736 L/284	14629 L/312	6795 L/183	6221 L/367	17958 L/366	27037 L/451		
	36"	-	-	13233 L/221	5149 L/122	-	17958 L/284	27037 L/364		
	48"	-	-	11568 L/166	-	-	16502 L/214	27037 L/306		
28'	16"	4793 L/173	4668 L/347	13102 L/357	6692 L/223	7137 L/447	16134 L/414	24294 L/504		
	24"	-	-	12748 L/269	5560 L/149	5234 L/298	16134 L/326	24294 L/412		
	36"	-	-	11017 L/179	-	-	15432 L/232	24294 L/325		
	48"	-	-	9345 L/134	-	-	13659 L/174	24294 L/261		
30'	16"	3981 L/142	3945 L/284	11789 L/318	5650 L/183	6358 L/367	14558 L/375	21921 L/467		
	24"	-	-	10876 L/221	4512 L/122	2854 L/245	14558 L/285	21921 L/374		
	36"	-	-	9143 L/147	-	-	13036 L/190	21921 L/285		
	48"	-	-	-	-	-	11252 L/142	20802 L/214		

## DESIGN ASSUMPTIONS:

- These tables are limited to structures with a mean roof height of 30'.
- The vertical load capacity is valid for wall columns supporting roof and floor loads. The design dead load shall not exceed design live load.
- The vertical capacity has been reduced to allow for holes and notches. Refer to the Drilling & Notching guidelines on page 4 for more information.
- The vertical load capacity assumes an eccentricity of 1/6 of the wall thickness.
- These tables are based on: a wind speed of 130 mph IBC/IRC 2015 and IBC 2012, 100 mph IBC 2009 and IRC 2009/2012. The design wind pressures are based on Part 1, Chapter 30 of ASCE 7-16 for Components and Cladding; Wall Zone 4, Enclosed, Risk Category II structure with topographic factor of  $K_{zt} = 1.00$ , and importance factor of  $I = 1.00$  (when it applies).
- A load duration adjustment,  $C_D = 1.60$ , has been applied for wind.
- No repetitive member increase has been applied.
- Full-width blocking is assumed to be installed at 8' on-center or less.
- Design for a Single 1-1/2" wall column also requires continuous, full-length lateral support through connection to the exterior wall sheathing and interior gypsum wall board.
- The tabulated capacities assume the plates are the same material and grade as the stud except 1.35E LSL plates are used with LVL studs. For other plate material or grade a lower value may control. The designer must check the required vertical load against the bearing capacity for the plate and adjust the column size and/or spacing accordingly.

## ADDITIONAL NOTES:

- Height is the clear height of the column between the bottom plate and the lower top plate.
- The first value in each cell represents the allowable vertical load capacity of the column, in pounds (lbs). These capacities are either the allowable capacity for vertical loads acting alone (no horizontal wind pressure) or the capacity of the column after accounting for the bending induced by the horizontal wind pressure.
- The second value in each cell represents the deflection ratio (L/x) based on the horizontal wind pressure. The designer shall verify the correct deflection ratio limit for the intended application.
- This table is for members in Beam Orientation only.
- All members shall be solid, one-piece sections except for the built-up Double (2-ply). For a 3-ply and 4-ply built-up column, multiply the Double values by 1.5 and 2.0, respectively. See page 17 for the connection of built-up columns.
- Columns supporting a Tributary Width greater than 48" are beyond the scope of this table.
- Do not use a product where designated "-" without further analysis by a professional engineer.



# Typical Wall Framing & Wall Stud Example

## TYPICAL WALL FRAMING

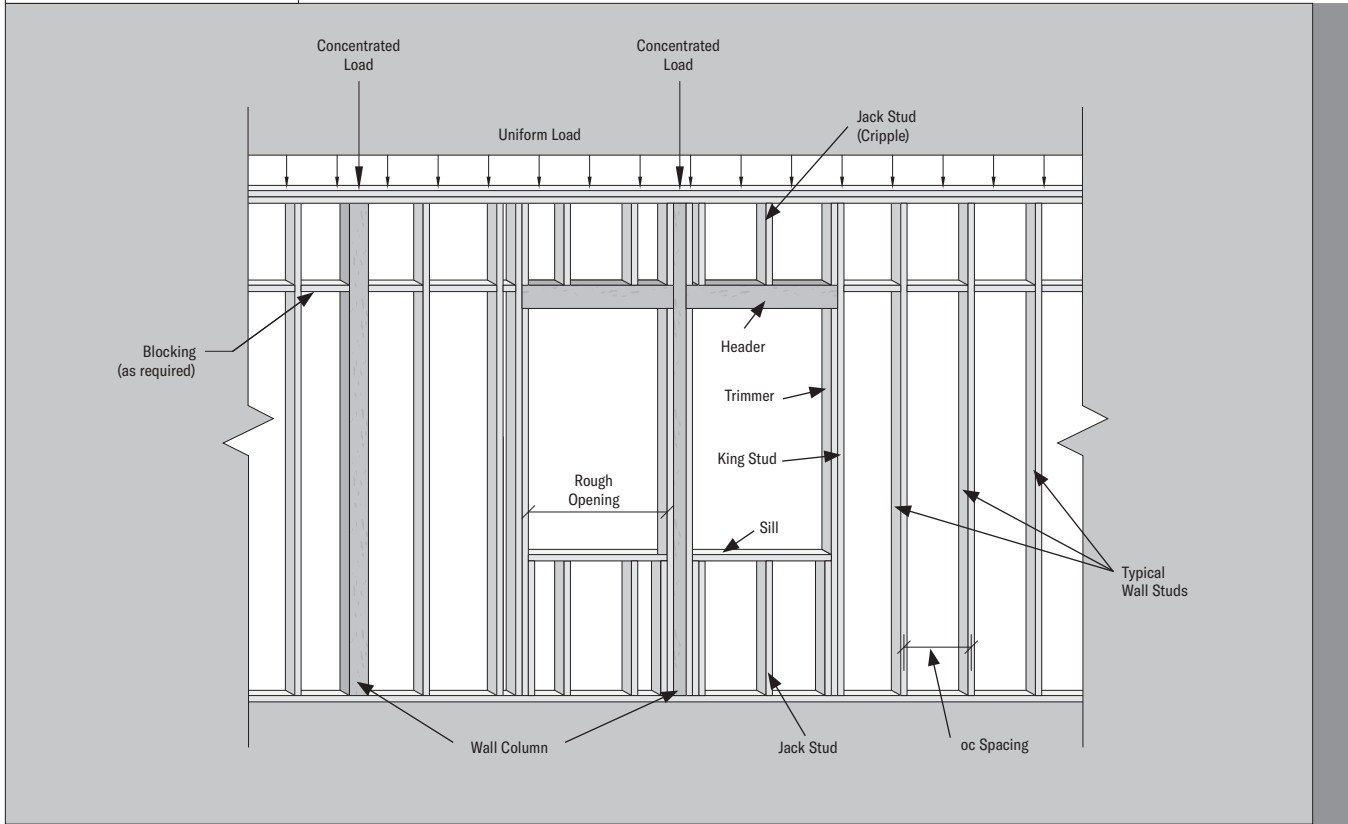

## TYPICAL WALL STUD EXAMPLE

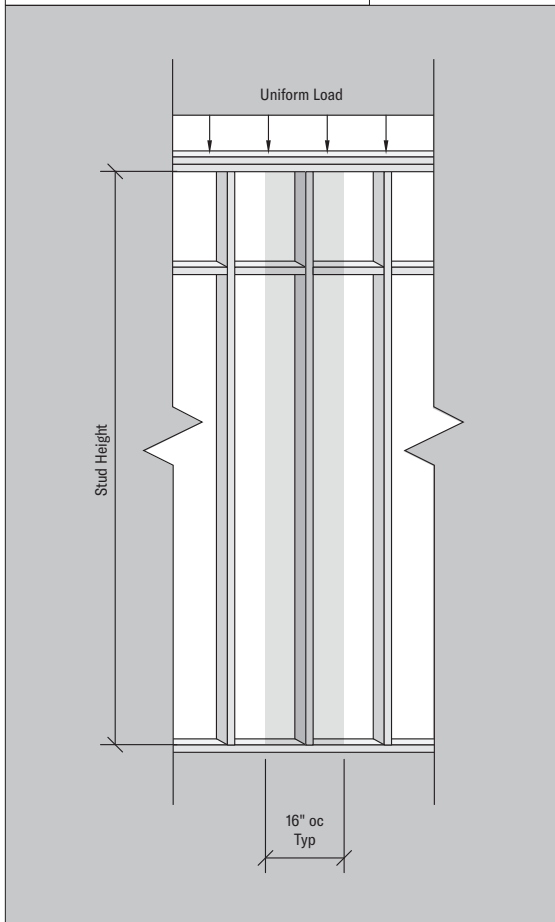

### HOW TO SIZE:

1. Determine the Basic Wind Speed.
2. Determine the Exposure Category.
3. Determine the clear height of the wall stud.
4. Determine the total vertical load (plf) applied to the wall studs from the roof and floor. Don't forget the wall weight!
5. Determine the allowable deflection ratio based on the wall construction.
6. Select the required grade and size from the appropriate chart for the desired wall stud spacing.

### EXAMPLE:

Select a suitable wall stud for a 9' first story wall for a residential structure located in a typical urban development in Pennsylvania. The wall supports the second floor and the roof of a 36' wide home. The second floor is supported at midspan and the roof trusses have a 1' overhang. The floor loads are 40 psf Live and 15 psf Dead load. The roof loads are 30 psf Snow (115%) and 17 psf Dead. Assume 100 plf for the weight of the second story wall. The exterior wall finish is "Windows and Doors."

### SOLUTION:

1. The example states the structure is located in Pennsylvania which, from the maps in the 2018 IBC, is normally considered a 115 mph Basic Wind Speed.
2. A typical urban development is normally an exposure B category provided that other structures of single-family size or larger are located in close proximity in all directions.
3. Use the height of the wall (9') as an approximation of the stud height.
4. The vertical load applied to each wall stud is:  
 Roof:  $(30 \text{ psf} + 17 \text{ psf}) * (36' / 2 + 1') = 798 \text{ plf}$   
 Wall: 100 plf  
 Floor:  $(40 \text{ psf} + 15 \text{ psf}) * (18' / 2) = 495 \text{ plf}$   
 Total Vertical Load =  $798 + 100 + 495 = 1488 \text{ plf}$
5. With a Windows and Doors finish, the deflection ratio shall be L/175 or better.
6. Using the 115 mph, Exposure B chart from the Wall Stud Capacity tables, for a standard wall stud spacing of 16" oc, select:

**1-1/2" x 3-1/2" 1.35E LP® SolidStart® LSL at 16" oc can support a vertical load of 1610 plf with a deflection ratio of L/351.**

# Typical Wall Framing: Trimmer & King Stud Examples

## TRIMMER AND KING STUD EXAMPLES

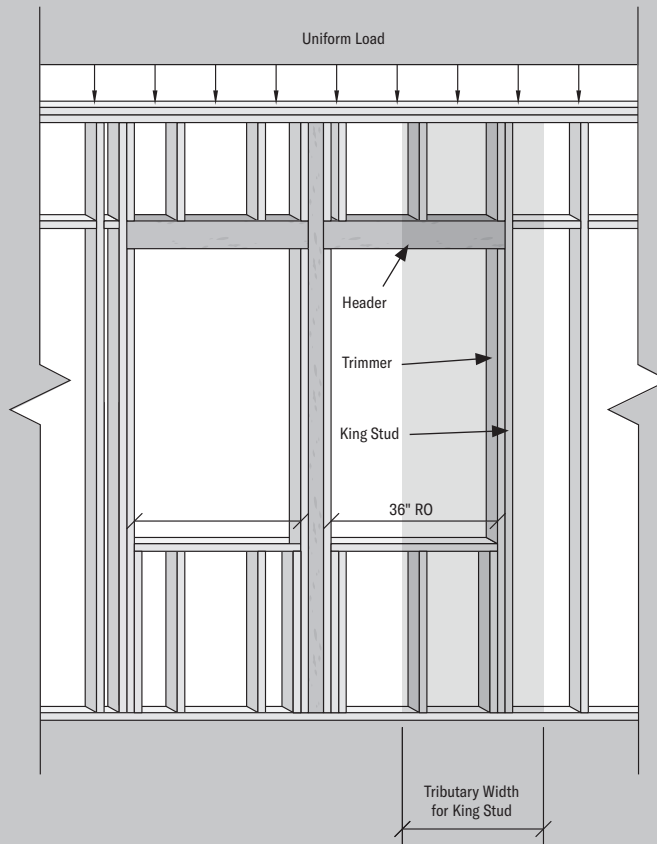

### TRIMMER

#### HOW TO SIZE:

**NOTE:** Trimmers are designed only for the vertical load applied by the header. The king stud will be designed for the lateral wind pressures.

1. Determine the clear height of the trimmer.
2. Determine the Tributary Width associated with the trimmer.
3. Determine the vertical load applied to the trimmer from the window header.
4. Select the required grade and size from the appropriate chart.

**Hint:** To size a trimmer, use the 12" oc row for the required height from the appropriate Wall Stud Capacity table. At 12" oc, the vertical capacity in plf is equivalent to the vertical capacity in lbs. Ignore the deflection for the trimmer.

#### EXAMPLE:

Select a suitable trimmer for a 3' (36") rough opening located in the first story wall of the Typical Wall Stud example. Assume the bottom of the window header is at a height of 7'-6".

#### SOLUTION:

1. With a header height of 7'-6", use 8' for the trimmer height in the tables.
2. Add 3" to the rough opening to approximate the overall length of the header, assuming single trimmers.  
Tributary Width =  $(36" \text{ RO} + 3") / 2 = 19.5"$
3. The vertical load applied to the trimmer from the header is:  
Roof: 893 plf (from Typical Wall Stud example)  
Wall:  $100 \text{ plf} * (1.5' / 9') = 17 \text{ plf}$   
(adjusted to the wall height supported by the header, approximately 1.5')  
Floor: 495 plf (from Typical Wall Stud example)  
Total Vertical Load on Trimmer =  $(893 + 17 + 495) * 19.5" / 12 = 2283 \text{ lbs}$
4. Using the 115 mph, Exposure B chart from the Wall Stud Capacity tables, for a spacing of 12" oc, select:  
**1-1/2" x 3-1/2" 1.35E LP® SolidStart® LSL trimmer can support a vertical load of 2739 lbs.**

**NOTE:** The allowable bearing capacity of the header should always be verified. In this example, if the header were a double SPF 2x6, a second trimmer would be required under each end of the header. Based on a 425 psi allowable bearing stress for SPF lumber, the bearing capacity is only 1912 lbs.  $(425 \text{ psi} * 1.5" * 3")$  versus a reaction of 2283 lbs.

### KING STUD

#### HOW TO SIZE:

**NOTE:** Design the king stud like an exterior wall column. To size as a single 1-1/2" thick member, the king stud must be attached to the adjacent wall stud by an exterior wall sheathing and interior gypsum wall board (or similar).

1. Determine the clear height of the king stud.
2. Determine the Tributary Width for the lateral wind pressure.
3. Determine the total vertical load (lbs) applied to the king stud.
4. Determine the allowable deflection ratio based on the wall construction.
5. Select the required grade and size from the appropriate chart.

#### EXAMPLE:

Select a suitable king stud for the same rough opening from the Trimmer example.

#### SOLUTION:

1. The king stud will be the same height as the typical wall stud - 9' in this example.
2. The Tributary Width for the wind pressure on the king stud is from the middle of the rough opening to half the clear distance from the king stud to the middle of the adjacent typical wall stud. Check the distance from the king stud to adjacent wall stud on both sides of the window. If not known, and for this example, assume a full wall stud spacing.  
Tributary Width =  $19.5"$  (from Trimmer example) +  $16"$  (to next stud) +  $1.5"$  (assuming a single king stud) =  $29"$   
Use 36" as next largest Tributary Width.
3. The applied vertical load on the king stud is based on half the spacing to the next adjacent wall stud. Again, check the distance on both sides of the opening. If not known, and for this example, assume a full wall stud spacing.  
Total Vertical Load =  $1488 \text{ plf} * (16" / 12) / 2 = 992 \text{ lbs}$
4. As in the typical wall stud example, use a deflection ratio of L/360 for stucco.
5. Using the table for Exterior Wall Column Capacity: 2x4 & 2x6 for 115 mph Wind, Exposure B, select:  
**3-1/2" x 3-1/2" 1.35E LP SolidStart LSL king stud can support a vertical load of 4351 lbs with a deflection ratio of L/369.**

# Typical Wall Framing: Wall Column Examples

## WINDOW COLUMN EXAMPLE

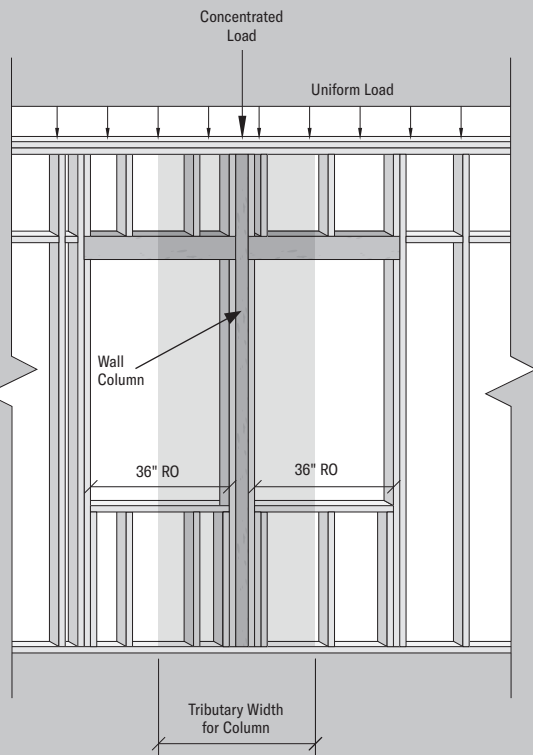

### HOW TO SIZE

1. Determine the clear height of the column.
2. Determine the Tributary Width for the lateral wind pressure.
3. Determine the total vertical load (lbs) applied to the column.
4. Determine the allowable deflection ratio based on the wall construction.
5. Select the required grade and size from the appropriate chart.

### EXAMPLE:

This column sits between two windows, both 36" rough openings, in the wall from the previous example. For this example, there is no additional concentrated load applied. The only vertical loads will be the uniform load from the roof trusses, second story wall and the second floor.

### SOLUTION:

1. The column will be the same height as the typical wall stud – 9'.
2. The Tributary Width for the wind pressure will be half the rough opening to both sides plus the width of the column and the trimmers. Since the width of the column is not known but the only vertical loads are the uniform loads from the common trusses, try a double 1-1/2" x 3-1/2" column.  

$$\text{Tributary Width} = 2 * (36" / 2) + 2 * 1\text{-}1/2" \text{ (trimmers)} + 2 * 1\text{-}1/2" \text{ (double 1-1/2" column)} = 42"$$
 Use 48" as next largest Tributary Width.
3. The applied vertical load on the column will only be the uniform load from the common roof trusses between the trimmers – assume a typical stud spacing of 16" for simplicity. The trimmers will support the vertical load from the window headers.  

$$\text{Total Vertical Load} = 1488 \text{ plf}$$
 (from Typical Wall Stud example) \* 16" oc / 12 = 1984 lbs
4. Again, use a deflection ratio of L/360 for stucco.
5. Using the table for Exterior Wall Columns: 2x4 & 2x6 for 115 mph Wind, Exposure B, select:  
**5-1/2" x 3-1/2" 1.35E LP SolidStart® LSL column can support a vertical load of 7630 lbs with a deflection ratio of L/404.**

## WALL COLUMN EXAMPLE

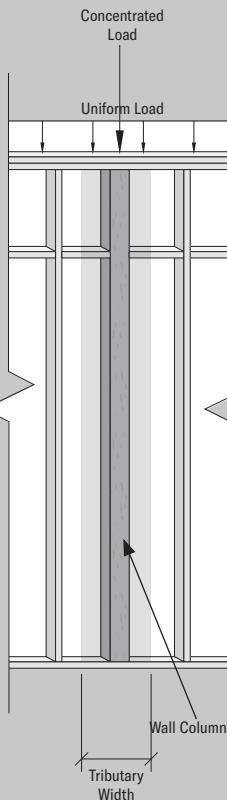

### HOW TO SIZE

1. Determine the clear height of the column.
2. Determine the Tributary Width for the lateral wind pressure.
3. Determine the total vertical load (lbs) applied to the column.
4. Determine the allowable deflection ratio based on the wall construction.
5. Select the required grade and size from the appropriate chart.

### EXAMPLE:

Based on the conditions from the typical wall stud example, select a wall column in the same first story wall to support a girder truss load of 4020 lbs. The design must include the weight of the second story wall and the load from the second floor.

### SOLUTION:

1. The column will be the same height as the typical wall stud - 9' in this example.
2. The Tributary Width for the wind pressure will be the same as that from the typical stud example: 16"  
**Hint:** Even if this column falls off-center between two typical studs, the Tributary Width is still 16" (in this case) as the total oc distance between the adjacent studs is 32"
3. The applied vertical load on the column will be the girder truss load transferred through the second story wall column, the tributary area of the second floor and the tributary weight of the second story wall (both the same as in the typical wall stud).  
 Roof: 4020 lbs  
 Wall: 100 plf x 16" oc / 12 = 134 lbs  
 Floor: 495 plf x 16" oc / 12 = 660 lbs  
 Total Vertical Load = 4020 + 134 + 660 = 4814 lbs
4. As in the typical wall stud example, use a minimum deflection ratio of L/360 for stucco.
5. Using the table for Exterior Wall Columns: 2x4 & 2x6 for 115 mph Wind, Exposure B, select:  
**3-1/2" x 3-1/2" 1.35E LP SolidStart LSL column can support a vertical load of 5034 lbs with a deflection ratio of L/545.**



# Free-Standing Interior Column Capacity (lbs)

## TO USE:

1. Determine the height of the column. If not listed, select the next tallest Height in the table.
2. Select the row corresponding to the required load duration.
3. Select the LP® SolidStart® LSL or LVL grade and size where the Vertical Load Capacity meets or exceeds the applied vertical load.
4. Verify the bearing capacity of the support for the selected column. See Design Assumption 6 below.

Height	Load Duration	1.35E LP LSL			1.75E LP LSL		
		3-1/2" x 3-1/2"	3-1/2" x 5-1/2"	3-1/2" x 7-1/4"	3-1/2" x 3-1/2"	3-1/2" x 5-1/2"	3-1/2" x 7-1/4"
4'	100%	10397	16338	21537	10396	16336	21534
	115%	10397	16338	21537	10396	16336	21534
	125%	10397	16338	21537	10396	16336	21534
6'	100%	7607	11957	15761	10388	16324	21518
	115%	8075	12690	16728	10388	16324	21518
	125%	8343	13110	17285	10388	16324	21518
8'	100%	5285	8306	10948	7093	11146	14694
	115%	5501	8649	11397	7360	11569	15251
	125%	5626	8842	11655	7516	11811	15571
9'	100%	4461	7006	9239	5956	9359	12342
	115%	4618	7256	9564	6152	9668	12745
	125%	4709	7400	9755	6265	9845	12978
10'	100%	3803	5977	7879	5061	7954	10484
	115%	3921	6164	8128	5208	8185	10789
	125%	3991	6271	8267	5291	8317	10963
12'	100%	2848	4476	5899	3770	5923	7812
	115%	2920	4589	6050	3858	6064	7996
	125%	2962	4654	6136	3911	6145	8101
14'	100%	2206	3468	4569	2910	4573	6028
	115%	2253	3541	4668	2968	4664	6147
	125%	2280	3584	4723	3000	4716	6216

Height	Load Duration	2.0E LP LVL					
		3-1/2" x 5-1/2"	3-1/2" x 7-1/4"	3-1/2" x 9-1/4"	5-1/4" x 5-1/2"	5-1/4" x 7-1/4"	5-1/4" x 9-1/4"
4'	100%	16340	21539	27481	24510	32309	41222
	115%	16340	21539	27481	24510	32309	41222
	125%	16340	21539	27481	24510	32309	41222
6'	100%	16329	21525	27463	24494	32287	41194
	115%	16329	21525	27463	24494	32287	41194
	125%	16329	21525	27463	24494	32287	41194
8'	100%	12557	16555	21115	24477	32266	41166
	115%	13041	17193	21935	24477	32266	41166
	125%	13324	17563	22408	24477	32266	41166
9'	100%	10556	13919	17760	24469	32255	41153
	115%	10915	14392	18356	24469	32255	41153
	125%	11121	14663	18708	24469	32255	41153
10'	100%	8985	11844	15113	24174	31864	40651
	115%	9256	12201	15571	24461	32244	41139
	125%	9411	12405	15827	24461	32244	41139
12'	100%	6711	8843	11286	18833	24829	31680
	115%	6875	9063	11559	19565	25788	32905
	125%	6969	9186	11719	19986	26343	33613
14'	100%	5187	6840	8727	14992	19761	25214
	115%	5296	6981	8906	15481	20404	26033
	125%	5357	7062	9009	15764	20773	26496
16'	100%	-	-	-	12176	16050	20477
	115%	-	-	-	12520	16498	21050
	125%	-	-	-	12713	16754	21378
18'	100%	-	-	-	10066	13269	16926
	115%	-	-	-	10312	13594	17345
	125%	-	-	-	10452	13779	17581
20'	100%	-	-	-	8450	11140	14214
	115%	-	-	-	8636	11383	14525
	125%	-	-	-	8741	11522	14704

## DESIGN ASSUMPTIONS:

1. Column Height is the clear height of the column between top and bottom supports.
2. The vertical load capacity is the total vertical load applied to the column, including all dead loads. No lateral loads have been applied.
3. The vertical capacity is for a full cross-section only. Notching and drilling are not allowed without further analysis by a professional engineer except as required for the proper installation of column caps, bases and other hold-downs. Bolts, lag screws and self-tapping screws shall only be inserted through the face of the column, perpendicular to the face of the strands in LP LSL and the veneers in LP LVL.
4. The capacity assumes an eccentricity of 1/6 of the column depth or width, whichever controls.
5. Interior columns are assumed to be braced in both directions at the top and bottom supports.
6. The tabulated capacities have been limited by the bearing capacity of 2500 psi concrete. For bearing on a lower strength concrete or a wood plate, the designer shall check the required vertical load against the bearing capacity for the plate and increase the column size accordingly. Refer to the Bearing Capacity table on page 4 for column bearing on LP SolidStart LSL and LP LVL, or for the common species of Hem-Fir and SPF. No increase is allowed without complete analysis of the vertical capacity of the column.

## ADDITIONAL NOTES:

1. The value in each cell represents the allowable vertical load capacity of a column, in pounds (lbs).
2. The column dimensions are for one-piece members. Built-up columns are beyond the scope of this table.
3. Do not use a product where designated "-" without further analysis by a professional engineer.
4. For columns embedded in interior walls where drilling or notching may be required, use the Exterior Wall Column Capacity tables for 115 mph, Exposure B, for the appropriate wall thickness (page 6 for 2x4 and 2x6, page 8 for 2x8, or page 10 for 2x10).

# Nailing and Connection Details

## WALL SHEATHING PANEL EDGE NAILING

### SINGLE STUD AT ADJOINING PANELS

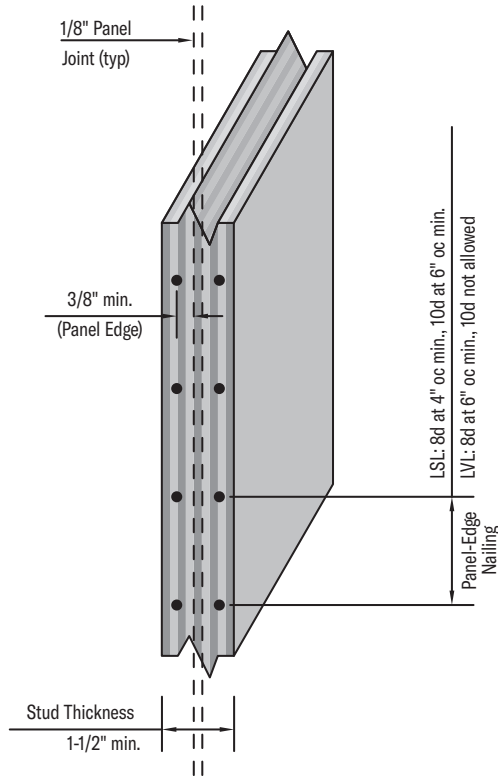

### DOUBLE STUD AT ADJOINING PANELS

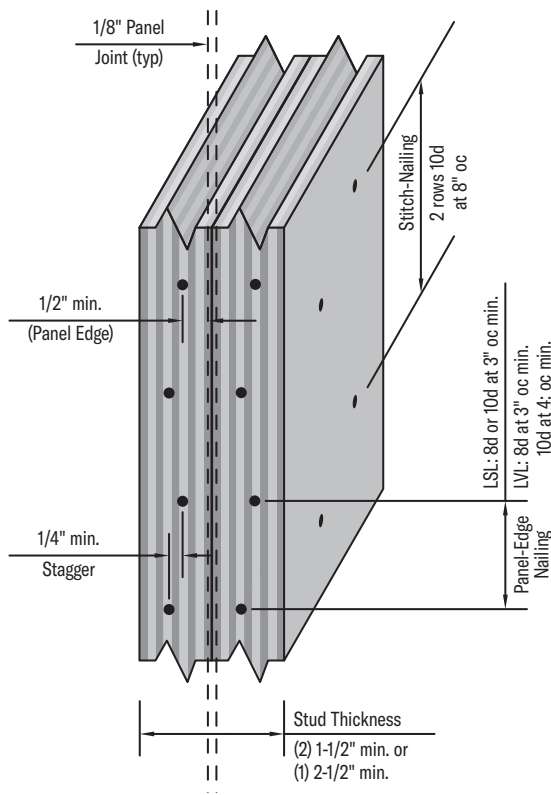

### NOTES:

- Minimum LP® SolidStart® LSL or LVL thickness for a single stud is 1-1/2".
- A double stud (or a minimum 2-1/2" single stud) are required at adjoining panel edges as follows:
  - For LP SolidStart LSL when using 8d common nails spaced closer than 4" oc or 10d common nails spaced closer than 6" oc.
  - For LP SolidStart LVL when using 8d common nails spaced closer than 6" oc. 10d common nails are not allowed for a single stud.
- The panel-edge nailing at a double stud shall be installed a minimum 1/2" from both the panel edge and the edge of the stud, and shall be installed with every other nail staggered a minimum 1/4" horizontally.
- The minimum nail spacing into the edge of the stud shall not be less than:
  - For LP SolidStart LSL: 3" oc for both 8d and 10d common nails.
  - For LP SolidStart LVL: 3" oc for 8d common nails or 4" oc for 10d common nails.
- Do not use nails larger than 10d common nails for wall sheathing nailing.
- In lieu of engineering analysis for prescriptive wall framing, the double studs shall be stitch-nailed together with 2 staggered rows of 10d common nails spaced 8" oc in each row. For engineered walls, the stitch nailing shall be designed to transfer the required lateral shear.

# Nailing and Connection Details

## FASTENER DESIGN

Material	Equivalent Specific Gravity					
	Nails and Wood Screws				Bolts and Lag Screws	
	Withdrawal		Dowel Bearing		Dowel Bearing (into the face only)	
	Edge	Face	Edge	Face	Load Applied Parallel to Grain	Load Applied Perpendicular to Grain
LP® SolidStart® LSL	0.46	0.50	0.50	0.55	0.50	0.58
LP SolidStart LVL	0.46	0.50	0.50	0.50	0.46	0.50

### NOTES:

1. Connection design using the equivalent specific gravity for each connection type listed above is for normal load duration and shall be adjusted according to code.
2. Fastener spacing, end and edge distance shall be as specified by code except for nail spacing as specified below.
3. See details at right for fastener and applied load orientation.

## FASTENER & LOAD ORIENTATION

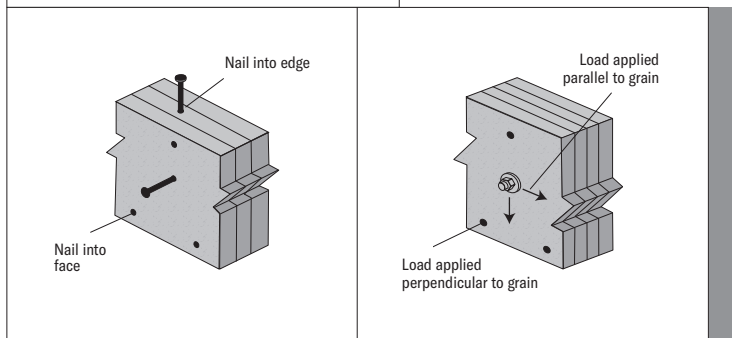

## NAIL SPACING REQUIREMENTS

Material	Ply Thickness	Fastener Orientation	Nail Size (common or box)	Minimum End Distance	Minimum Nail Spacing per Row	
					Single Row	Multiple Rows
LP SolidStart LSL	≥ 1-1/2"	Edge	8d	2"	3"	3"
			10d or 12d	2"	3"	4"
			16d	2-1/2"	4" <sup>5</sup>	6"
		Face	8d	7/8"	1"	1"
			10d or 12d	7/8"	1"	1"
			16d	7/8"	1-1/2"	1-1/2"
LP SolidStart LVL	≥ 1-1/2"	Edge	8d	2-1/2"	3"	4" <sup>6</sup>
			10d or 12d	2-1/2"	4"	5" <sup>6</sup>
			16d	3-1/2"	5"	6" <sup>7</sup>
		Face	8d	1-1/2"	3"	3"
			10d or 12d	1-1/2"	3"	3"
			16d	1-1/2"	5"	5"

### NOTES:

1. Edge distance shall be such that does not cause splitting.
2. Multiple rows of nails shall be offset at least 1/2" and staggered, and equally spaced about the centerline of the edge or face (whichever applies).
3. Edge orientation refers to nails driven into the narrow edge; parallel to the face of the strands for LP LSL or the face of the veneer for LP LVL. Face orientation refers to nails driven into the wide face; perpendicular to the face of the strands for LP LSL or the face of the veneer for LP LVL. (See Fastener & Load Orientation details at right.)
4. 16d sinkers (3-1/4" x 0.148") may be spaced the same as the 10d or 12d common nail.
5. Single row spacing for 16d nails into the edge can be reduced to 3" for 1-3/4" or thicker LSL.
6. Minimum nail spacing is tabulated for LVL manufactured from the Sutherlin plant (Mill number 1089). The minimum nail spacing may be reduced by 1 inch for LVL manufactured from the Wilmington and Golden plants (Mill numbers 1077 and 1066).
7. Minimum nail spacing may be reduced by 1 inch for 1-3/4-inch thick (or greater) LVL manufactured from the Sutherlin plant (Mill number 1089).



# Typical Connections

NAILED PLATE CONNECTIONS				
Nail Type	Length	Diameter	Lateral Capacity (lbs)	
			Toe-Nail (lbs)	End-Nail
8d box	2-1/2"	0.113"	95	68
8d common	2-1/2"	0.131"	128	79
10d box	3"	0.128"	123	99
10d common	3"	0.148"	156	126
16d sinker	3-1/4"	0.148"	156	126
16d box	3-1/2"	0.135"	136	110
16d common	3-1/2"	0.162"	187	151

**NOTE:**

- The lateral capacity assumes a load duration adjustment for wind,  $C_d = 1.60$ .
- Connections assume an equivalent specific gravity of 0.50 for both the side member and main member. For an SPF plate (SG=0.42), multiply the tabulated lateral capacities by 0.84. For a Hem-Fir plate (SG=0.46), multiply the tabulated lateral capacities by 0.93.
- Toe-nail connections assume a toe-nail adjustment factor,  $C_{tn} = 0.83$  for lateral capacity.
- End-nail connections assume an end grain adjustment factor,  $C_{eg} = 0.67$  for lateral capacity.

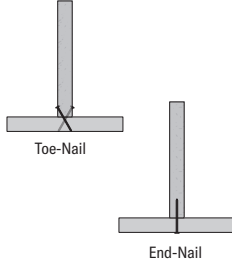

TYPICAL FRAMING ANCHORS			
Anchor Type	Number of Nails	Capacity (lbs)	
		Force 1	Force 2
<b>Simpson Strong-Tie®</b>			
A21	(4) 10d x 1-1/2"	175	365
A23	(8) 10d x 1-1/2"	565	715
A34	(8) 8d x 1-1/2"	515	455
A35	(12) 8d x 1-1/2"	695	670
<b>MiTek® Structural Connectors</b>			
A3	(8) 10d x 1-1/2"	590	600
AC5	(6) 10d	540	540
AC7	(8) 10d	725	725
AC9	(10) 10d	905	905

**NOTE:**

- Refer to the manufacturers' current catalogs for complete information.
- Capacities assume both members being equivalent to Doug Fir-Larch or Southern Pine, with an equivalent specific gravity of 0.50 or better.
- Capacities are for a load duration adjustment for wind,  $C_d = 1.60$ .
- Capacities are for a single anchor and may be doubled when installed in pairs. Doubled anchors are required to achieve Force 2 capacity on both directions.

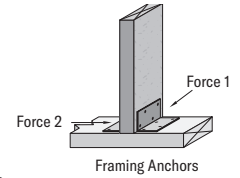

### CONNECTION OF BUILT-UP COLUMNS

Built-up columns shall be designed in accordance with the NDS using the following recommended nailing and bolt patterns.

**1-1/2" x 3-1/2"**

**2-Ply**

**3-Ply**

10d box nails (3" x 0.128")

- One row spaced 6" oc.
- Drive every other nail from opposite faces and offset horizontally.
- Stagger rows on each face and from front to back.

**1-1/2" x 5-1/2" and 1-1/2" x 7-1/4"**

**2-Ply**

**3-Ply**

10d box nails (3" x 0.128")

- Two rows spaced 6" oc.
- Drive every other nail in a row from opposite faces.
- Stagger rows.

**2-Ply and 3-Ply 1-1/2" x 9-1/4"**

- Three rows of 10d box nails spaced 6" oc from both faces.
- Stagger rows on each face and from front to back.

**4-Ply 1-1/2" x 5-1/2" and wider (not shown)**

- Two rows of 1/2" bolts spaced 8" oc.
- Maintain a 2" minimum edge distance and 4" minimum end distance.

**NOTES:**

- Larger nails may be used. Do not exceed 12d common (0.148") or 16d box (0.135") nail.
- Except as specified herein, nail spacing, row spacing, edge distance and end distance shall be in accordance with the NDS.
- Do not exceed three plies for 1-1/2" x 3-1/2" wide members.

### TYPICAL CONNECTIONS

**BEAM ON COLUMN CAP**

**COLUMN BASE**

**ELEVATED COLUMN BASE**

Optional non-shrink grout

**BEAM ON COLUMN**

1-1/4" LSL or LVL or 1-1/8" rim board or blocking for lateral support

Column

Framing anchor as required for lateral load

Use trimmers as required

**EXAMPLES OF FRAMING ANCHORS**



### Floor Beams

- 1.75E LSL typically replaces like sizes of LVL
- 3½" thickness allows one-piece construction
- Higher strength than lumber results in longer spans that stay straight



### Door & Window Headers

- 3½" thickness provides one-piece header installation with no build-up required
- Stays straight, reducing the likelihood of drywall cracking around window and door framing
- Ideal in sliding glass door and specialty window header applications because it resists twisting and shrinking
- Less prone to nail pops because it stays consistent



### Garage Door Headers

- 3½" thickness provides one-piece header with no build-up required
- Cost-effective alternative to comparable LVL products
- Long lengths can allow continuous framing over garage return walls in high wind and seismic areas
- True 3½" thickness compared to 3¼" glulam



### Roof Framing

- 3½" thickness provides one-piece roof beam construction
- Ideal for complex and contemporary roof rafters, hips, ridges and valleys
- Higher strength than lumber results in longer rafter spans that stay straight
- Cost-effective alternative to comparable LVL products

# HANDLING & STORAGE GUIDELINES

- **WARNING:** Failure to follow proper procedures for handling, storage and installation could result in unsatisfactory performance, unsafe structures and possible collapse.
- Keep LP® SolidStart® Engineered Wood Products dry. These products are intended to resist the effects of moisture on structural performance from normal construction delays but are not intended for permanent exposure to the weather.
- Unload products carefully, by lifting. Support the bundles to reduce excessive bowing. Individual products should be handled in a manner which prevents physical damage during measuring, cutting, erection, etc. I-Joists shall be handled vertically and not flatwise.
- Keep products stored in wrapped and strapped bundles, stacked no more than 10' high. Support and separate bundles with 2 x 4 (or larger) stickers spaced no more than 10' apart. Keep stickers in line vertically.
- Product must not be stored in contact with the ground, or have prolonged exposure to the weather.
- Use forklifts and cranes carefully to avoid damaging product.
- Do not use a visually damaged product. Call your local LP SolidStart Engineered Wood Products distributor for assistance when damaged products are encountered.
- For satisfactory performance, LP SolidStart Engineered Wood Products must be used under dry, covered and well-ventilated interior conditions in which the equivalent moisture content in lumber will not exceed 16%.
- For built-up members, LP SolidStart I-Joists, LSL and LVL shall be dry before nailing or bolting to avoid trapping moisture.
- LP SolidStart I-Joists, LSL and LVL shall not be used for unintended purposes such as ramps and planks.

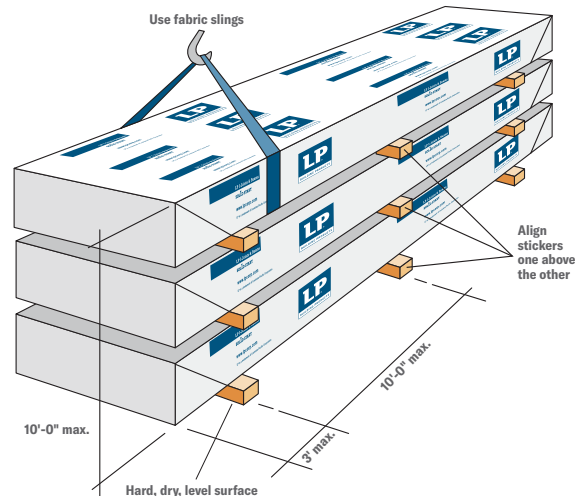

## LP SolidStart LSL 1.35E, 1.55E and 1.75E

Standard Thicknesses of 1-1/2" and 3-1/2"  
(also 1-3/4")

Standard Depths of 3-1/2", 5-1/2", 7-1/4" and 9-1/4"  
(other depths are available)

Lengths up to 48'

## LP SolidStart LVL 2.0E

Standard Thickness of 1-1/2" and 1-3/4"  
Billet thicknesses of 3-1/2" and 5-1/4"

Standard Depths of 5-1/2", 7-1/4" and 9-1/4"  
(other depths are available)

Lengths up to 60'

## CODE EVALUATION

Code evaluation reports can be obtained at [www.lpcorp.com](http://www.lpcorp.com)

ICC-ES ESR-2403

APA PR-L280

Florida FL15228

A water-resistant coating called SiteCote™ is applied to LP LSL and LVL for extra weather protection during construction.

For more information on the full line of LP SolidStart Engineered Wood Products or the nearest distributor, visit our web site at [LPCorp.com](http://LPCorp.com).

Phone: 1-888-820-0325

E-mail: [customer.support@LPCorp.com](mailto:customer.support@LPCorp.com).

LP SolidStart Engineered Wood Products are manufactured at different locations in the United States and Canada.



Good for you. Good for our forests.  
[www.sfi-program.org](http://www.sfi-program.org)

BV-SFICOC-US09000262



PEFC/29-31-102



**For product catalog & complete warranty details, visit [LPCorp.com](http://LPCorp.com)**

### Cal. Prop 65 Warning:



**WARNING:** Drilling, sawing, sanding or machining wood products can expose you to wood dust, a substance known to the State of California to cause cancer. Avoid inhaling wood dust or use a dust mask or other safeguards for personal protection. For more information go to [www.P65Warnings.ca.gov/wood](http://www.P65Warnings.ca.gov/wood).

© 2020 Louisiana-Pacific Corporation. All rights reserved. APA and APA Rated are registered trademarks of APA - The Engineered Wood Association. IBC and IRC are registered trademarks of the International Code Council, Inc. SIMPSON Strong-Tie® is a registered trademark of Simpson Strong-Tie Company, Inc. MiTek® is a registered trademark of MiTek Holdings, Inc. SFI and the associated logo are trademarks of Sustainable Forestry Initiative, Inc. PEFC and the associated logo are trademarks of Programme for the Endorsement of Forest Certification. LP® and SolidStart® are registered trademarks of Louisiana-Pacific Corporation. Printed in USA. Specifications (details) subject to change without notice.

NOTE: Louisiana-Pacific Corporation periodically updates and revises its product information. To verify that this version is current, contact the nearest sales office, visit [LPCorp.com](http://LPCorp.com), or call 1-888-820-0325.