

Marino\WARE® Product Submittal Data

PRODUCT NAME: FAS TRACK 1000 Deep Leg - Fire, Air & Smoke Protection

Nomenclature: 600FTDL200-33

PROPERTIES:

A. Web (in)	6	Yield Strength Fy (KSI)	33
Flange (in)	2	Design Thickness (in)	0.0346
Mils	33	Minimum Thickness (in)	0.0329
Finish	G40	Gauge	20 STR

FIRE RATED DESIGNS (UL 2079):

HW-D-0514	HW-D-0553
HW-D-0518	HW-D-0573
HW-D-0524	HW-D-0620
HW-D-0550	HW-D-0624
HW-D-0551	HW-D-0652

CODES & STANDARDS

- IBC 2015, 2012
- Steel and coating meets ASTM A1003

GREEN INFO

- LEED v3 & LEED v4 credits available
- Contact Technical Services for more information

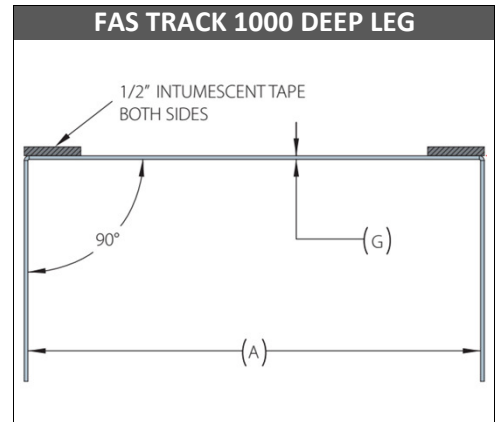

For more information, please contact Marino\WARE Technical Services at 866-545-1545.

This technical information reflects the most current information available and supersedes any and all publications, effective 4/1/2016

©Copyright 2016 by Ware Industries, Inc. All rights reserved