

# Marino\WARE® Product Submittal Data

**PRODUCT NAME:** FAS TRACK 1000 SLOTTED - Fire, Air & Smoke Protection

**Nomenclature:** 400FT275-54

**PROPERTIES:**

<b>A. Web (in)</b>	4	<b>Yield Strength Fy (KSI)</b>	50
<b>Flange (in)</b>	2-3/4	<b>Design Thickness (in)</b>	0.0566
<b>Mils</b>	54	<b>Minimum Thickness (in)</b>	0.0538
<b>Finish</b>	G60	<b>Gauge</b>	16



**FIRE RATED DESIGNS (UL 2079):**

HW-D-0514	HW-D-0554
HW-D-0518	HW-D-0573
HW-D-0524	HW-D-0620
HW-D-0550	HW-D-0624
HW-D-0551	HW-D-0652
HW-D-0553	WW-D-0104

**CODES & STANDARDS**

- IBC 2015, 2012
- Steel and coating meets ASTM A1003

**GREEN INFO**

- LEED v3 & LEED v4 credits available
- Contact Technical Services for more information

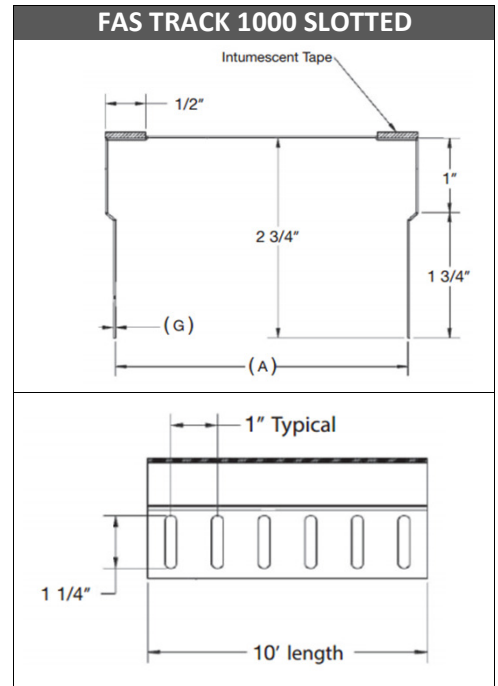

**ALLOWABLE LOADS:**

MODEL NO. <sup>1</sup>	DESIGN THICKNESS (in)	MINIMUM THICKNESS (in)	YIELD (ksi)	COATING	WEB SIZES (in)	GAP <sup>2</sup> (in)	ALLOWABLE LOAD <sup>3</sup> PER STUD (lb)	LOAD AT 1/8 INCH DEFLECTION <sup>4</sup> (lb)
33	0.0346	0.0329	33	G40	2 1/2 3 5/8 4 6 8	5/8	125	30
43	0.0451	0.0428	33	G60	2 1/2 3 5/8 4 6 8	5/8	160	50
54	0.0566	0.0538	50	G60	2 1/2 3 5/8 4 6 8	5/8	280	90
68	0.0713	0.0677	50	G60	3 5/8 4 6 8	5/8	385	155

For SI: 1 inch = 25.4mm, 1 lbf = 4.448 N, 1 ksi = 6.8948 kPa, 1 lb/ft = 14.5939 N/m

<sup>1</sup>See the last two digits in the section designation in Table 2.

<sup>2</sup>The gap is the maximum distance between end of the stud and the web of the track.

<sup>3</sup>Loads are allowable strength loads (ASD). For load and resistance factor design (LRFD) multiply by 1.54.

<sup>4</sup>Deflection is the deflection of the edge of the flange away from the web of the FAS Track 1000.



www.marinoware.com

For more information, please contact Marino\WARE Technical Services at 866-545-1545.

This technical information reflects the most current information available and supersedes any and all publications, effective 4/1/2016

©Copyright 2016 by Ware Industries, Inc. All rights reserved