

Marino\WARE® Product Submittal Data

MARINO\WARE PART # BRC6 BridgeRite Clip

MATERIAL: 16 ga (54 mil) 50ksi

FINISH: Galvanized – G90

Part No.	Size (in.)
BRC3	3-5/8", 4"
BRC6	6", 8"

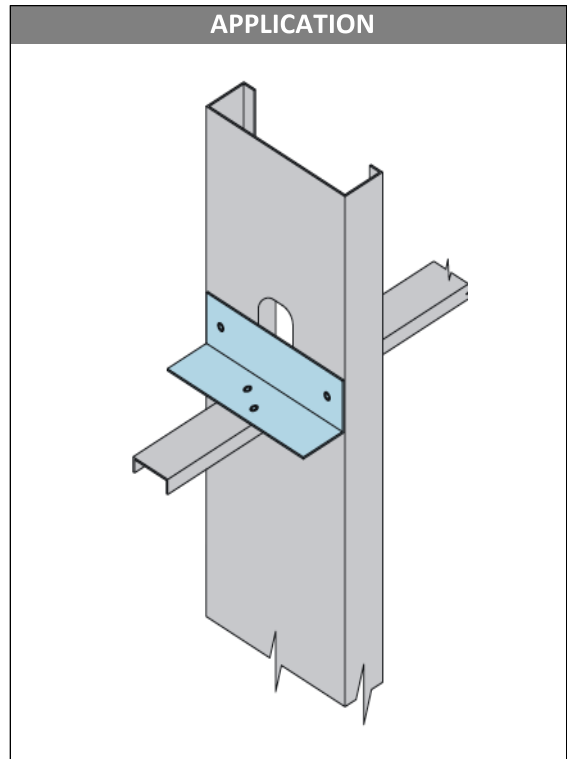
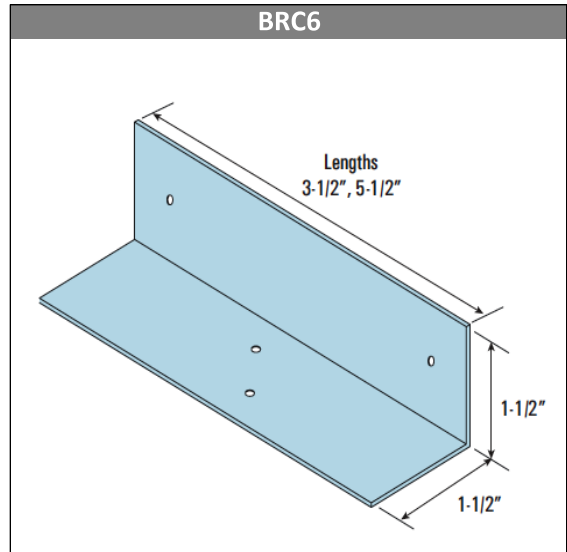

CODES & STANDARDS

- Steel meets ASTM A1003
- Coating meets ASTM A1003, A653

GREEN INFO

- LEED v4 credits available
- Contact Technical Services for more information

ClipSource™