

## Design/System/Construction/Assembly Usage Disclaimer

- Authorities Having Jurisdiction should be consulted in all cases as to the particular requirements covering the installation and use of UL Certified products, equipment, system, devices, and materials.
  - Authorities Having Jurisdiction should be consulted before construction.
  - Fire resistance assemblies and products are developed by the design submitter and have been investigated by UL for compliance with applicable requirements. The published information cannot always address every construction nuance encountered in the field.
  - When field issues arise, it is recommended the first contact for assistance be the technical service staff provided by the product manufacturer noted for the design. Users of fire resistance assemblies are advised to consult the general Guide Information for each product category and each group of assemblies. The Guide Information includes specifics concerning alternate materials and alternate methods of construction.
  - Only products which bear UL's Mark are considered Certified.
- 

## BXUV - Fire Resistance Ratings - ANSI/UL 263 Certified for United States

## BXUV7 - Fire Resistance Ratings - CAN/ULC-S101 Certified for Canada

[See General Information for Fire-resistance Ratings - ANSI/UL 263 Certified for United States Design Criteria and Allowable Variances](#)

[See General Information for Fire Resistance Ratings - CAN/ULC-S101 Certified for Canada Design Criteria and Allowable Variances](#)

**Design No. V473**

August 07, 2018

**Nonbearing Wall Ratings — 1, 2, 3, or 4 Hr**

**\* Indicates such products shall bear the UL or cUL Certification Mark for jurisdictions employing the UL or cUL Certification (such as Canada), respectively.**

**System A - 1 Hr.**

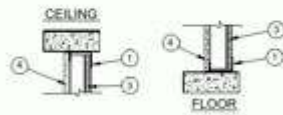
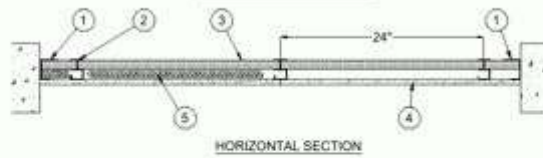

**System B - 2 Hr.**

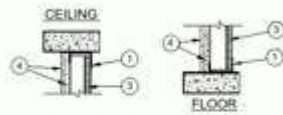

**System C - 2 Hr.**

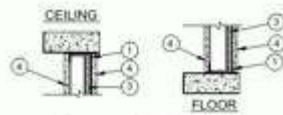
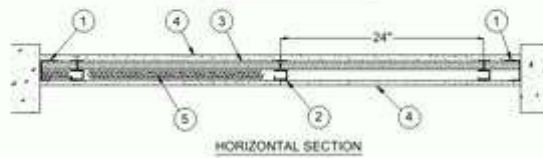

**System D - 3 Hr.**

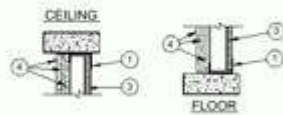
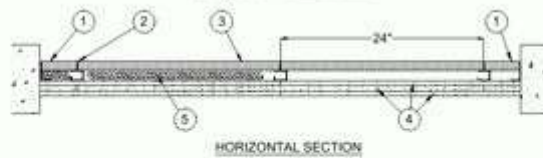

**System E - 3 Hr.**

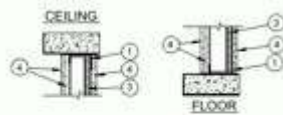
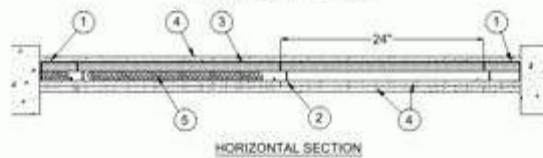

**System F - 4 Hr.**

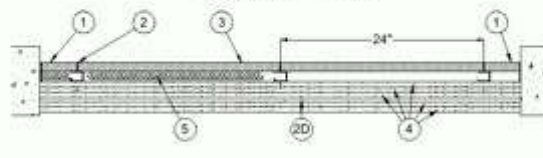

HORIZONTAL SECTION

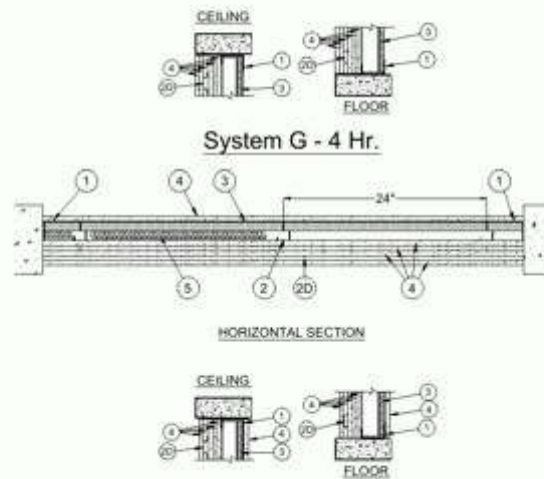

1. **Channel Track** — "J" -shaped channel, min. 2-1/2 in. deep (min 4 in. deep when System F or G is used), with unequal legs of 1 in. and 2-1/4 in., fabricated from No. 25 MSG galv steel. Channel positioned with short leg toward finished side of wall. Channel attached to structural supports with steel fasteners located not greater than 2 in. from ends and not greater than 24 in. OC.

1A. **Steel Framing Members (Floor, Side and Ceiling Runners)\*** — As an alternate to Item 1. "J"-shaped runner, min 2-1/2 in. deep (min 4 in. deep when System F or G is used), with unequal legs of 1 in. and min 2-1/4 in. fabricated from min 25 MSG galv steel (0.0179 in. bare steel thickness). Runners positioned with short leg toward finished side of wall. Runners attached to structural supports with steel fasteners located not greater than 2 in. from ends and not greater than 24 in. OC. Runners may be supplied with securement tabs for gypsum liner panels (refer to Item 3).

**SCAFCO STEEL STUD MANUFACTURING CO** — I-Stud Shaftwall Steel Framing System

2. **Steel Studs** — "C-T" - shaped studs, min 2-1/2 in. deep (min 4 in. deep when System F or G is used) , fabricated from min 25 MSG galv steel. Cut to lengths 1 in. less than floor to ceiling height and spaced 24 in. OC. Studs friction-fit into channel track.

2A. **Steel Studs** — "C-H" -shaped studs, min 2-1/2 in. deep (min 4 in. deep when System F or G is used), fabricated from min 25 MSG galv steel. Cut to lengths 1 in. less than floor to ceiling height and spaced 24 in. OC. Studs friction-fit into channel track.

2B. **Steel Framing Members (Steel Studs)\*** — As an alternate to Item 2. For use with Item 1A - "I"-shaped studs fabricated from min 25 MSG galv steel, min 2-1/2 in. deep (min 4 in. deep when System F or G is used), 1-1/2 in. wide. Studs contain 3/4 in. wide by 2-1/4 in. high holding tabs spaced 2-3/4 in. OC. Cut to lengths 5/8 in. less than floor-to-ceiling height and spaced 24 in.

**SCAFCO STEEL STUD MANUFACTURING CO** — I-Stud Shaftwall Steel Framing System

2C. **Furring Channels** — (Optional, Not Shown) — For single or double layer systems only. Resilient furring channels fabricated from min 25 MSG corrosion protected steel, installed horizontally and spaced vertically a max of 24 in. OC. Flange portion of channel attached to each intersecting "C-T" or "C-H" stud on side of stud opposite the 1 in. liner panels using 1/2 in. long Type S or S-12 pan-head steel screws. When furring channels are used, gypsum board to be applied vertically.

2D. **Furring Channels** — For use with System F or G — "Hat" shaped, min. 25 MSG galv steel furring channels attached directly over the three inner layers of gypsum board to each stud with 2-1/2 in. long Type S bugle head steel screws. Screws alternate from top flange to bottom flange at each stud intersection. Furring channels spaced vertically max 16 in. OC.

3. **Gypsum Board\*** — 1 in. thick gypsum liner panels, supplied in nom 24 in. widths. Panels cut 1 in. less in length than floor to ceiling heights. Vertical edges inserted in "C-T", "C-H", or "I" studs. Free edge of end panels attached to long leg of channel track with 1-5/8 in. long Type S self-drilling, self-tapping bugle head steel screws spaced 12 in. OC. As an alternate to attaching the free edge to the channel track, the free edge of the end panels may be held in place by the tabs in the channel track pulled out every 24 in. When wall height exceeds liner panel length, liner panel may be butted to extend to the full height of the wall, and the horizontal butt joints need not be backed by steel framing. In Systems D through G, horizontal butt joints in liner panels are staggered min 36 in. and backed with 6 in. by 22 in. strips of 1 in. thick gypsum board (Item 3). Gypsum board strips centered over butt joints and secured to liner panels with six 1-1/2 in. long Type G steel screws, three screws along the 22 in. dimension at the top and bottom of the strips. For all Systems, when J-shaped runners (Item 1A) are supplied with securement tabs, free edge of end panels may be secured by bending the securement tabs, max 12 in. OC, to a 90 degree angle to securely friction-fit panels into J-shaped runners.

**GEORGIA-PACIFIC GYPSUM L L C** — Types DGUSL and TRSL

#### 4. **Gypsum Board\*** —

### **System A - 1 Hr**

5/8 in. thick, 4 ft wide gypsum board applied horizontally or vertically. Vertical joints centered over studs. Attached to studs with 1 in. long Type S self-drilling, self-tapping bugle head steel screws spaced 8 in. OC along the edges and in the field of the boards. When furring channels (Item 2B) are used, board to be applied vertically and to be attached to furring channels with 1 in. long Type S self-drilling, self-tapping bugle head steel screws spaced max 8 in. OC. Joints covered with paper tape and joint compound. Exposed screw heads covered with joint compound.

**GEORGIA-PACIFIC GYPSUM L L C** — Types 6, 9, C, DAP, DAPC, DGG, DS, TG-C, Type X, Veneer Plaster Base - Type X, Water Rated - Type X, Sheathing - Type X, Soffit - Type X, Type LWX, Veneer Plaster Base-Type LWX, Water Rated-Type LWX, Sheathing Type-LWX, Soffit-Type LWX, Type DGLW, Water Rated-Type DGLW, Sheathing Type- DGLW, Soffit-Type DGLW, Type LW2X, Veneer Plaster Base - Type LW2X, Water Rated - Type LW2X, Sheathing - Type LW2X, Soffit - Type LW2X, Type DGL2W, Water Rated - Type DGL2W, Sheathing - Type DGL2W

### **System B - 2 Hr**

5/8 in. thick, 4 ft wide gypsum board applied in two layers. Base layer applied horizontally or vertically, face layer applied vertically. Vertical joints centered over studs. Base layer attached to studs with 1 in. long Type S self-drilling, self-tapping bugle head steel screws spaced 24 in. OC along the edges and in the field of the boards. Face layer attached with 1-5/8 in. long Type S self-drilling, self-tapping bugle head steel screws spaced 12 in. OC along the top and bottom tracks and 12 in. OC in the field and along the vertical edges, staggered from screws in base layer. Joints between base and face layers staggered min. 24 in. When furring channels (Item 2B) are used, base layer to be applied vertically and to be attached to furring channels with 1 in. long Type S self-drilling, self-tapping bugle head steel screws spaced max 12 in. OC. Outer or face layer attached to furring channels with 1-5/8 in. long Type S self-drilling, self-tapping bugle head steel screws spaced 12 in. OC and staggered 6 in. from base layer screws. Joints between inner and outer layers staggered. Face layer joints covered with paper tape and joint compound. Exposed screw heads covered with joint compound.

**GEORGIA-PACIFIC GYPSUM L L C** — Types 6, 9, C, DAP, DAPC, DGG, DS, TG-C, Type X, Veneer Plaster Base - Type X, Water Rated - Type X, Sheathing - Type X, Soffit - Type X, Type LWX, Veneer Plaster Base-Type LWX, Water Rated-Type LWX, Sheathing Type-LWX, Soffit-Type LWX, Type DGLW, Water Rated-Type DGLW, Sheathing Type- DGLW, Soffit-Type DGLW, Type LW2X, Veneer Plaster Base - Type LW2X, Water Rated - Type LW2X, Sheathing - Type LW2X, Soffit - Type LW2X, Type DGL2W, Water Rated - Type DGL2W, Sheathing - Type DGL2W.

## System C - 2 Hr

5/8 in. thick, 4 ft wide gypsum board applied vertically. Vertical joints centered over studs. Attached to studs with 1 in. long Type S self-drilling, self-tapping bugle head steel screws spaced 12 in. OC along the edges and in the field of the boards. When furring channels (Item 2B) are used, gypsum board to be applied vertically and to be attached to furring channels with 1 in. long Type S self-drilling, self-tapping bugle head steel screws spaced max 12 in. OC. Joints covered with paper tape and joint compound. Exposed screw heads covered with joint compound.

**GEORGIA-PACIFIC GYPSUM L L C** — Types 6, 9, C, DAP, DAPC, DGG, DS, TG-C, Type X, Veneer Plaster Base - Type X, Water Rated - Type X, Sheathing - Type X, Soffit - Type X, Type LWX, Veneer Plaster Base-Type LWX, Water Rated-Type LWX, Sheathing Type-LWX, Soffit-Type LWX, Type DGLW, Water Rated-Type DGLW, Sheathing Type- DGLW, Soffit-Type DGLW, Type LW2X, Veneer Plaster Base - Type LW2X, Water Rated - Type LW2X, Sheathing - Type LW2X, Soffit - Type LW2X, Type DGL2W, Water Rated - Type DGL2W, Sheathing - Type DGL2W.

## System D - 3 Hr

5/8 in. thick, 4 ft wide gypsum board, applied vertically or horizontally in three layers. Inner or base layer attached to studs with 1 in. long Type S steel screws spaced 24 in. OC. Middle layer attached to studs with 1-5/8 in. long Type S steel screws spaced 12 in. OC. Outer or face layer attached to studs with 2-1/4 in. long Type S steel screws spaced 12 in. OC. Screws offset 6 in. from layer below. Horizontal joints on adjacent layers staggered a min of 12 in. Horizontal joints need not be backed by steel framing. Vertical joints centered over studs and staggered 24 in. on adjacent layers.

**GEORGIA-PACIFIC GYPSUM L L C** — Types DAPC and TG-C

## System E — 3 Hr

5/8 in. thick, 4 ft wide gypsum board, applied vertically or horizontally, two layers over the flange of the "C" section of the studs, one layer over the flange of the "H" section of the studs. Inner or base layer attached to studs with 1 in. long Type S steel screws spaced 24 in. OC. Face layer attached to studs with 1-5/8 in. long Type S steel screws spaced 12 in. OC. Screws offset 6 in. from layer below. Horizontal joints on adjacent layers staggered a min of 12 in. Horizontal joints need not be backed by steel framing. Vertical joints centered over studs and staggered 24 in. on adjacent layers

**GEORGIA-PACIFIC GYPSUM L L C** — Types DAPC and TG-C

## System F - 4 Hr.

5/8 in. thick, 4 ft wide gypsum board applied vertically in five layers. Vertical joints centered over steel studs (Item 2) and staggered min 24 in. First layer secured to studs with 1-1/8 in. long Type S self-drilling, self-tapping bugle-head steel screws spaced 12 in. OC at the perimeter and in the field. Second layer secured to studs with 1-5/8 in. long Type S self-drilling, self-tapping bugle-head steel screws spaced 12 in. OC at the perimeter and in the field. Horizontal butt joints in second layer shall be secured to first layer of gypsum board with 1-1/2 in. long Type G screws spaced 8 in. OC on both sides of the joint. Third layer secured to studs with 2-1/4 in. long Type S self-drilling, self-tapping bugle-head steel screws spaced 12 in. OC at the perimeter and in the field. Third layer also secured to inner layers with 1-1/2 in. long Type G screws spaced 12 in. OC vertically and centered between the Type S screws in the studs. Horizontal butt joints in third layer shall be secured to inner layers of gypsum board with 1-1/2 in. long Type G screws spaced 8 in. OC on both sides of the joint. Fourth layer secured to the furring channels (Item 2D) with 1-1/8 in. long Type S self-drilling, self-tapping bugle-head steel screws spaced 12 in. OC. Horizontal butt joints in fourth layer shall be centered over furring channels (Item 2D) and secured to furring channels with 1-1/8 in. long Type S self-drilling, self-tapping bugle-head steel screws spaced 12 in. OC on both sides of the joint. Fifth layer secured to furring channels with 1-5/8 in. long Type S self-drilling, self-tapping bugle-head steel screws spaced 12 in. OC. Fifth layer also secured to fourth layer with 1-1/2 in. long Type G screws spaced 16 in. OC along the vertical joints and centered between the Type S screws in the furring channels. Horizontal butt joints in fifth layer shall be centered over furring channels (Item 2D) and secured to furring channels with 1-5/8 in. long Type S self-drilling, self-tapping bugle-head steel screws spaced 12 in. OC on both sides of the joint. Screws and horizontal butt joints staggered.

**GEORGIA-PACIFIC GYPSUM L L C** — Types DAPC and TG-C

## System G - 4 Hr.

5/8 in. thick, 4 ft wide gypsum board applied vertically, four layers over the "C" section of the studs, one layer over the flange of the "H" section of the studs. Vertical joints centered over steel studs (Item 2) and staggered min 24 in. First layer secured to studs with 1-1/8 in. long Type S self-drilling, self-tapping bugle-head steel screws spaced 12 in. OC at the perimeter and in the field. Second layer secured to studs with 1-5/8 in. long Type S self-drilling, self-tapping bugle-head steel screws spaced 12 in. OC at the perimeter and in the field. Horizontal butt joints in second layer shall be secured to first layer of gypsum board with 1-1/2 in. long Type G screws spaced 8 in. OC on both sides of the joint. Third layer secured to studs with 2-1/4 in. long Type S self-drilling, self-tapping bugle-head steel screws spaced 12 in. OC at the perimeter and in the field. Third layer also secured to inner layers with 1-1/2 in. long Type G screws spaced 12 in. OC vertically and centered between the Type S screws in the studs. Horizontal butt joints in third layer shall be secured to inner layers of gypsum board with 1-1/2 in. long Type G screws spaced 8 in. OC on both sides of the joint. Fourth layer secured to the furring channels (Item 2D) with 1-1/8 in. long Type S self-drilling, self-tapping bugle-head steel screws spaced 12 in. OC. Horizontal butt joints in fourth layer shall be centered over furring channels (Item 2D) and secured to furring channels with 1-1/8 in. long Type S self-drilling, self-tapping bugle-head steel screws spaced 12 in. OC on both sides of the joint.

**GEORGIA-PACIFIC GYPSUM L L C** — Types DAPC and TG-C

5. **Batts and Blankets\*** — (Optional) Mineral wool or glass fiber batts partially or completely filling stud cavity. Any mineral wool or glass fiber batt bearing the UL Classification Marking as to Fire Resistance. See **Batts and Blankets** (BZJZ) category for names of Classified companies.

**\* Indicates such products shall bear the UL or cUL Certification Mark for jurisdictions employing the UL or cUL Certification (such as Canada), respectively.**

Last Updated on 2018-08-07

---

The appearance of a company's name or product in this database does not in itself assure that products so identified have been manufactured under UL Solutions' Follow - Up Service. Only those products bearing the UL Mark should be considered to be Certified and covered under UL Solutions' Follow - Up Service. Always look for the Mark on the product.

UL Solutions permits the reproduction of the material contained in Product iQ subject to the following conditions: 1. The Guide Information, Assemblies, Constructions, Designs, Systems, and/or Certifications (files) must be presented in their entirety and in a non-misleading manner, without any manipulation of the data (or drawings). 2. The statement "Reprinted from Product iQ with permission from UL Solutions" must appear adjacent to the extracted material. In addition, the reprinted material must include a copyright notice in the following format: "©2024 UL LLC."