

Marino\WARE® Product Submittal Data

PRODUCT NAME: 800SLT250-68

PROPERTIES:

Web (in.)	8	Yield Strength F_y (ksi)	50
Flange (in.)	2-1/2	Tensile Strength F_u (ksi)	65
Mils	68	Design Thickness (in.)	0.0713
Coating	G60, G90	Minimum Thickness (in.)	0.0677
Slot (in.)	1-1/2	Gauge	14

INSTALLATION NOTES:

- Slotted track thickness cannot be less than stud thickness.
- Max gap is 7/8" for 2-1/2" leg, 1-1/8" max gap for 3" leg, and 1-3/8" max gap for 3-1/2" leg.
- Use #8 x 9/16" wafer head screws for 30 mil and thinner track. For 33 mil and heavier gauges use #10 x 9/16" wafer head screw.

SECTION PROPERTIES

GROSS SECTION PROPERTIES

Cross sectional area: A (in. ²)	0.926
Weight of member: (lb/ft)	3.150
Moment of inertia about x-axis: I_x (in. ⁴)	8.980
Radius of gyration about x-axis: r_x (in.)	3.110
Moment of inertia about y-axis: I_y (in. ⁴)	0.509
Radius of gyration about y-axis: r_y (in.)	0.741

CODES & STANDARDS

- AISI S100 & S240
- ASTM A1003, A653, & C955
- IBC 2015, 2018, 2021

GREEN INFO

- LEED credits available
- Contact Technical Services for more information.

FIRE RATINGS (UL 2079)

Approved for these UL Head Of Wall Assemblies

HW-D-0003, HW-D-0020, HW-D-0021, HW-D-0024, HW-D-0025, HW-D-0029, HW-D-0031, HW-D-0032, HW-D-0033, HW-D-0034, HW-D-0036, HW-D-0042, HW-D-0043, HW-D-0044, HW-D-0045, HW-D-0046, HW-D-0049, HW-D-0054, HW-D-0056, HW-D-0059, HW-D-0062, HW-D-0063, HW-D-0071, HW-D-0072, HW-D-0073, HW-D-0076, HW-D-0077, HW-D-0079, HW-D-0082, HW-D-0083, HW-D-0084, HW-D-0085, HW-D-0087, HW-D-0088, HW-D-0089, HW-D-0099, HW-D-0101, HW-D-0102, HW-D-0103, HW-D-0104, HW-D-0105, HW-D-0106, HW-D-0107, HW-D-0108, HW-D-0111, HW-D-0127, HW-D-0128, HW-D-0129, HW-D-0130, HW-D-0134, HW-D-0136, HW-D-0137, HW-D-0144, HW-D-0146, HW-D-0152, HW-D-0154, HW-D-0162, HW-D-0170, HW-D-0173, HW-D-0179, HW-D-0180, HW-D-0184, HW-D-0185, HW-D-0190, HW-D-0191, HW-D-0194, HW-D-0205, HW-D-0209, HW-D-0210, HW-D-0217, HW-D-0218, HW-D-0221, HW-D-0222, HW-D-0241, HW-D-0242, HW-D-0243, HW-D-0247, HW-D-0249, HW-D-0252, HW-D-0257, HW-D-0259, HW-D-0260, HW-D-0263, HW-D-0264, HW-D-0265, HW-D-0271, HW-D-0272, HW-D-0278, HW-D-0283, HW-D-0288, HW-D-0292, HW-D-0295, HW-D-0297, HW-D-0298, HW-D-0299, HW-D-0313, HW-D-0321, HW-D-0322, HW-D-0324, HW-D-0342, HW-D-0363, HW-D-0365, HW-D-0371, HW-D-0377, HW-D-0380, HW-D-0381, HW-D-0388, HW-D-0396, HW-D-0453, HW-D-0456, HW-D-0457, HW-D-0483, HW-D-0484, HW-D-0485, HW-D-0486, HW-D-0514, HW-D-0515, HW-D-0518, HW-D-0523, HW-D-0524, HW-D-0541, HW-D-0542, HW-D-0545, HW-D-0546, HW-D-0547, HW-D-0548, HW-D-0549, HW-D-0550, HW-D-0551, HW-D-0553, HW-D-0554, HW-D-0556, HW-D-0653, HW-D-0654, HW-D-0659, HW-D-0670, HW-D-0671, HW-D-0672, HW-D-0673, HW-D-0677, HW-D-0679, HW-D-0680, HW-D-0682, HW-D-0683, HW-D-0684, HW-D-0696, HW-D-0620, HW-D-0621, HW-D-0622, HW-D-0623, HW-D-0644, HW-D-0645, HW-D-0646, HW-D-0652, HW-D-0653, HW-D-0667, HW-D-0705, HW-D-0740, HW-D-0741, HW-D-0747, HW-D-0748, HW-D-0749, HW-D-0750, HW-D-0778, HW-D-0801, HW-D-0826, HW-D-0863, HW-D-0868, HW-D-0871, HW-D-0872, HW-D-0873, HW-D-0874, HW-D-0875, HW-D-0876, HW-D-0880, HW-D-0884, HW-D-0886, HW-D-0905, HW-D-0906, HW-D-0907, HW-D-0923, HW-D-0925, HW-D-0936, HW-D-0937, HW-D-0940, HW-D-0941, HW-D-0942, HW-D-0945, HW-D-0946, HW-D-0947, HW-D-0959, HW-D-0960, HW-D-0964, HW-D-1155, HW-D-1158, HW-S-0133.

05.40.00 Cold-Formed Metal Framing

SLOTTED TRACK (SLT)

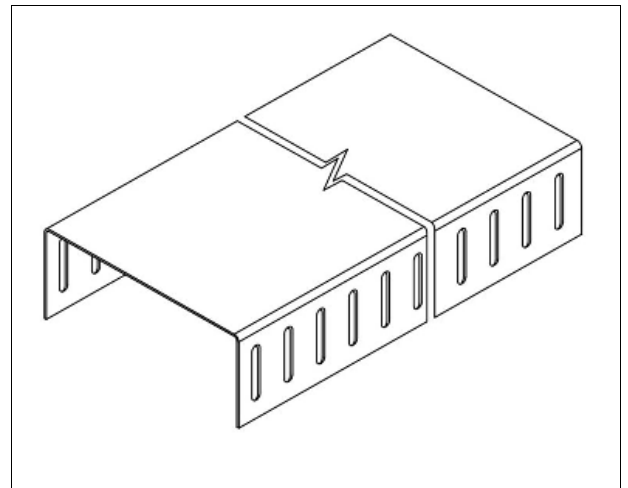
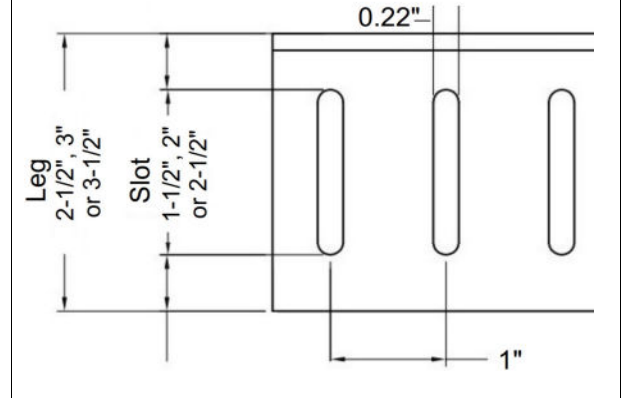

For more information, please contact Marino\WARE Technical Services at 866-545-1545.

This technical information reflects the most current information available and supersedes any and all publications, effective 3/15/2024
©Copyright 2024 by Ware Industries, Inc. All rights reserved