

PRODUCT CATALOG

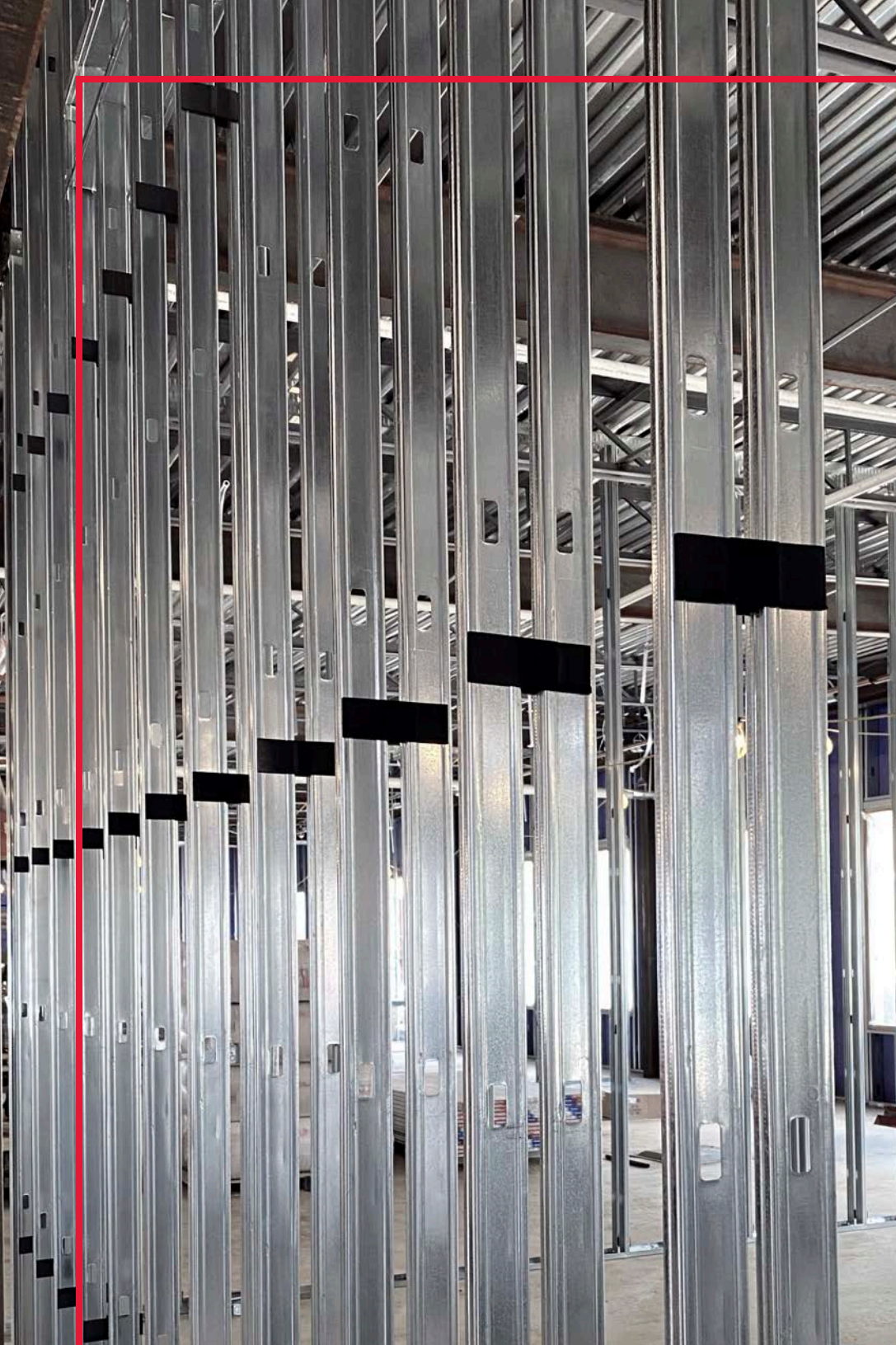

**SOUND** **GUARD**<sup>®</sup>  
THE SILENT STEEL FRAMING SYSTEM

**MARINO** **WARE**<sup>®</sup>

# ★ The SoundGuard® Silent Steel Framing System

## NEW Interior Sound Rated Framing System

U.S. Patents: #9,523,197; 9,771,715 Canadian Patent: 2,893,390.

### Features and Benefits

- **Narrower Walls** - Which Means More Usable Square Feet
- **Lower Material Costs** - No CRC, Thinner Steel, Smaller Web
- **Faster Build-out** - Single Wall Installation
- **STC-Equal or Better**
- **1 & 2 HOUR Fire Rating UL V463, W475**
- **Available in 3½", 4", and 6" Wall Assemblies**

### Architect/Owner

- **Narrower Allowable Wall Thicknesses** with Better or Equal STC Ratings
  - Increased Room Dimensions
  - Greater Saleable Square Footage
  - Revenue Gains for Owner
- **Equivalent** to many Partition and Chase Wall Assemblies with Same STC
  - Eliminates Resilient Channel
  - Increases Rentable Square Footage
  - Half as Many Studs and Track to Install
  - No Cross Bracing and CRC Lateral Bracing

### Contractor

Replaces typical Partition and Chase Wall Assemblies with equal or lesser wall thicknesses

- **Lower Material Costs – Superior STC Ratings**
  - Reduces the Amount of Studs and Track to Install
  - No Resilient Sound Channel Required
  - No Cross Bracing and CRC Lateral Bracing
- **Faster Build-Out**, Saves Labor, Field Tested, Contractor Approved, Pre-Assembled With Built-in Air Space
- **Handles Just Like a Typical Single Stud**
- **Risk Reduction** Quoting, Planning, Stocking, Waste, Labor Over Runs, Durations
- **UL Rated** Achieves 1 & 2 Hour Fire Rating (ASTM E119)
- **Use Slotted Track for Deflection Conditions** in 3½", 4", and 6" Widths

### Warranty & Limitations

All products presented herein are warranted to the buyer to be free from defects in material and workmanship. The foregoing warranty is non-assignable and in lieu of and excludes all other warranties not expressly set forth herein, whether express or implied by operation of law or otherwise, including but not limited to any implied warranties of merchantability or fitness for a particular purpose. All details and specifications presented herein are intended as a general guide for the use of MarinoWARE® framing systems. These products should not be used without evaluation by a qualified engineer or architect to determine their suitability for a specific use.

MarinoWARE® assumes no responsibility for failure resulting from use of its details or specifications, or for failure resulting from improper application or installation of these products.

### Governing Law

All issues arising in connection with your order and all transactions associated with it shall be interpreted according to the laws of the State of New Jersey, and all actions or other proceedings arising out of such issues shall be brought only in Superior Court, State of New Jersey, County of Essex, or United States District Court for the District of New Jersey. No action may be brought more than one year after accrual of the cause of action therefore.

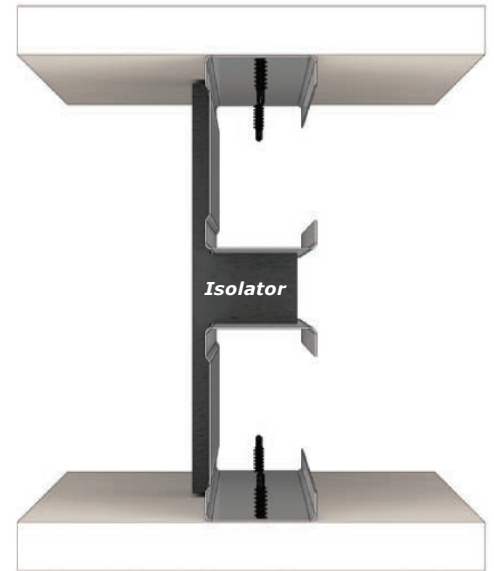

## Cost Benefit Example

- 26** Floors Containing Condo Units
- 10** Average Number of Units per Floor
- 260** Total Number of Units
- 284,815** Total Square Footage of Condo Space
- 18,200** Total Lineal Footage of Sound Wall

### † Traditional Double Stud Sound Wall

(See Height Comparisons on Page 8)

Two each 2½" studs with 1" air gap

6" total wall width x 18,200 lineal footage of wall = 9,100 sq.ft.

### † SoundGuard® Sound Wall

One each 3⅝" SoundGuard® stud

3⅝" total wall width x 18,200 lineal footage of wall = 5,498 sq.ft.

### † Savings of Square Footage

Traditional 9,100 sq.ft. - 5,498 sq.ft. SoundGuard® = **3,602 sq.ft.**

### † Total Dollar Savings to Owner

**3,602 sq.ft. x \$1,065\* = \$3,836,130**

\*Data based on average condo price of \$1,065.00/sq.ft. in Seattle, WA from www.highbises.com as of March 2017.

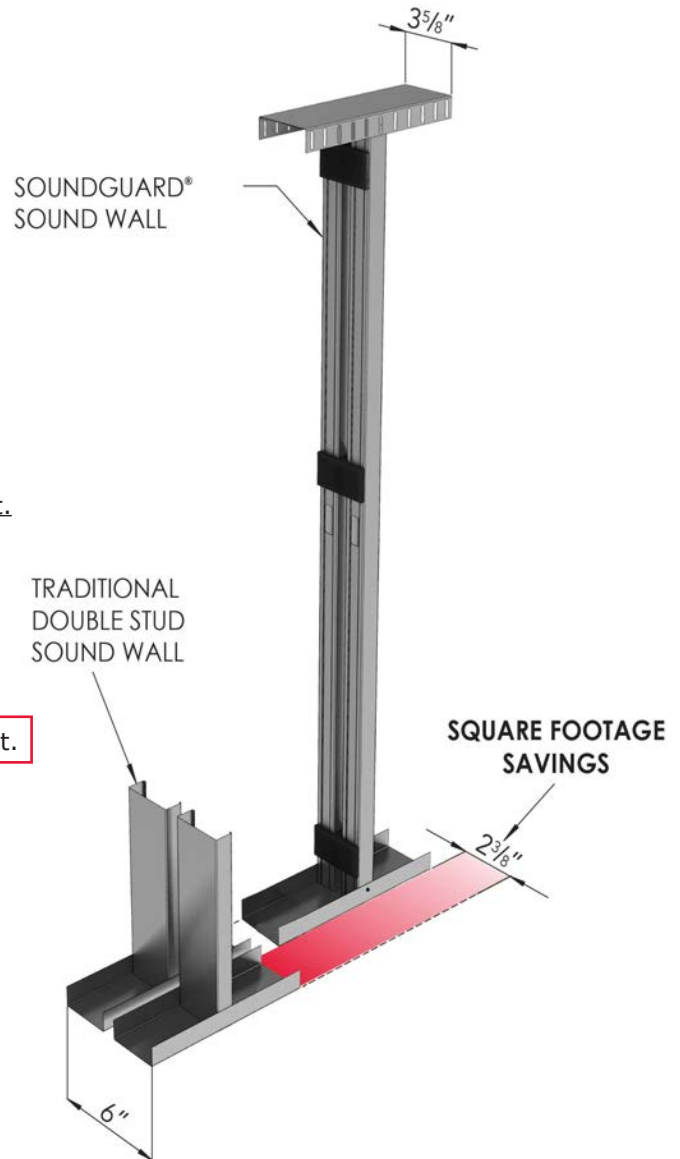

## Testing

### Riverbank Acoustical Laboratories & North Orbit Acoustic Laboratories

Sound assemblies were constructed, thoroughly inspected, and tested by accredited labs. Please visit, [www.northorbit.com](http://www.northorbit.com) or [www.alionscience.com/riverbank-acoustical-labratories](http://www.alionscience.com/riverbank-acoustical-labratories) for more information.

## Physical Properties

Member Designation	Yield Stress (KSI)	Design Thickness (in.)	Web Size (in.)	Flange
362SG162-18	70	0.0190	3-5/8	1-1/4 (2 x 162)
362SG162-30	40	0.0312	3-5/8	1-1/4 (2 x 162)
362SG162-43	40	0.0451	3-5/8	1-5/8 (2 x 162)
400SG162-18	70	0.0190	4	1-1/4 (2 x 162)
400SG162-30	40	0.0312	4	1-1/4 (2 x 162)
400SG162-43	40	0.0451	4	1-5/8 (2 x 162)
600SGPW162-18	70	0.0190	6	1-1/4 (2 x 162)
600SGPW162-30	40	0.0312	6	1-1/4 (2 x 162)
600SGPW162-43	40	0.0451	6	1-5/8 (2 x 162)
600SG250-18	70	0.0190	6	1-1/4 (2 x 250)
600SG250-30	40	0.0312	6	1-1/4 (2 x 250)
600SG250-43	40	0.0451	6	1-5/8 (2 x 250)

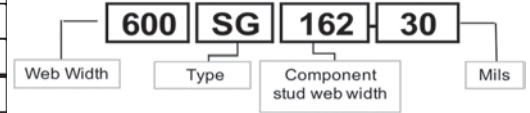

**Table Notes:**

- 0.0190" material is Viper20.
- Coatings per ASTM C645 or ASTM A 1003, Table 1.
- G60 & G90 available upon request (43 mil is G60).

## Composite Limiting Heights

MEMBER DESIGNATION	Stud Spacing (in. o.c.)	Design Thickness (in.)	F <sub>y</sub> (ksi)	5 psf			7.5 psf			10 psf		
				L/120	L/240	L/360	L/120	L/240	L/360	L/120	L/240	L/360
362SG162-18	12	0.0190	70	17' 1"	13' 6"	11' 10"	14' 11"	11' 10"	9' 10"	13' 6"	10' 5"	8' 8"
	16	0.0190	70	15' 6"	12' 4"	10' 5"	13' 6"	10' 5"	8' 8"	12' 4"	9' 1"	-
	24	0.0190	70	13' 6"	10' 5"	8' 8"	11' 10"	8' 8"	-	10' 5"	-	-
362SG162-30	12	0.0312	40	18' 3"	14' 6"	12' 8"	15' 11"	12' 8"	10' 9"	14' 6"	11' 4"	9' 5"
	16	0.0312	40	16' 7"	13' 2"	11' 4"	14' 6"	11' 4"	9' 5"	13' 2"	10' 0"	-
	24	0.0312	40	14' 6"	11' 4"	9' 5"	12' 8"	9' 5"	-	11' 4"	-	-
362SG162-43	12	0.0451	40	19' 7"	15' 7"	13' 7"	17' 2"	13' 7"	11' 10"	15' 7"	12' 4"	10' 3"
	16	0.0451	40	17' 10"	14' 2"	12' 4"	15' 7"	12' 4"	10' 3"	14' 2"	10' 11"	8' 10"
	24	0.0451	40	15' 7"	12' 4"	10' 3"	13' 7"	10' 3"	8' 4"	12' 4"	8' 10"	-
400SG162-18	12	0.0190	70	17' 1"	13' 6"	11' 10"	14' 11"	11' 10"	9' 10"	13' 6"	10' 5"	8' 8"
	16	0.0190	70	15' 6"	12' 4"	10' 5"	13' 6"	10' 5"	8' 8"	12' 4"	9' 1"	-
	24	0.0190	70	13' 6"	10' 5"	8' 8"	11' 10"	8' 8"	-	10' 5"	-	-
400SG162-30	12	0.0312	40	18' 3"	14' 6"	12' 8"	15' 11"	12' 8"	10' 9"	14' 6"	11' 4"	9' 5"
	16	0.0312	40	16' 7"	13' 2"	11' 4"	14' 6"	11' 4"	9' 5"	13' 2"	10' 0"	-
	24	0.0312	40	14' 6"	11' 4"	9' 5"	12' 8"	9' 5"	-	11' 4"	-	-
400SG162-43	12	0.0451	40	19' 7"	15' 7"	13' 7"	17' 2"	13' 7"	11' 10"	15' 7"	12' 4"	10' 3"
	16	0.0451	40	17' 10"	14' 2"	12' 4"	15' 7"	12' 4"	10' 3"	14' 2"	10' 11"	8' 10"
	24	0.0451	40	15' 7"	12' 4"	10' 3"	13' 7"	10' 3"	8' 4"	12' 4"	8' 10"	-
600SG250-18	12	0.0190	70	19' 11"	15' 10"	13' 10"	17' 5"	13' 10"	12' 1"	15' 10"	12' 7"	11' 0"
	16	0.0190	70	18' 1"	14' 4"	12' 7"	15' 10"	12' 7"	11' 0"	14' 4"	11' 5"	9' 11"
	24	0.0190	70	15' 10"	12' 7"	11' 0"	13' 10"	11' 0"	9' 6"	12' 7"	9' 11"	8' 0"
600SG250-30	12	0.0312	40	21' 1"	16' 9"	14' 8"	18' 5"	14' 8"	12' 9"	16' 9"	13' 3"	11' 7"
	16	0.0312	40	19' 2"	15' 3"	13' 3"	16' 9"	13' 3"	11' 7"	15' 3"	12' 1"	10' 6"
	24	0.0312	40	16' 9"	13' 3"	11' 7"	14' 8"	11' 7"	10' 1"	13' 3"	10' 6"	8' 10"
600SG250-43	12	0.0451	40	22' 6"	17' 10"	15' 7"	19' 7"	15' 7"	13' 7"	17' 10"	14' 2"	12' 4"
	16	0.0451	40	20' 5"	16' 2"	14' 2"	17' 10"	14' 2"	12' 4"	16' 2"	12' 10"	11' 3"
	24	0.0451	40	17' 10"	14' 2"	12' 4"	15' 7"	12' 4"	10' 9"	14' 2"	11' 3"	9' 9"

**Table Notes**

- Allowable composite limiting heights are calculated in accordance using ICC-ES AC 86-2012.
- The 5/8" Type X gypsum board must be applied full height vertically to each stud flange and installed using minimum No. 6 Type S Drywall screws spaced a maximum of 12 inch on-center for studs at 24 inch spacing, and 16 inch on-center for studs at 16 inch and 12 inch spacing.
- A screw is required from stud to each track flange.
- For deflection conditions, slotted track is required at head-of-wall.

## Sound Rating Data

### Single Layer 5/8" Type X GWB 1x1 Application

Wall Size	Application	STC Rating		Conventional Partition Range
		16" o.c. <sup>2</sup>	24" o.c. <sup>1</sup>	
3 5/8" Wall	2 - 1 5/8" Studs, Single GWB each side, 3-1/2" insulation batts	51	52	50-54
4" Wall	2 - 1 5/8" Studs, Single GWB each side, 3-1/2" insulation batts	51	52	
6" Wall	2 - 2 1/2" Studs, Single GWB each side, 6-1/2" insulation batts	53	52	

1. Based on 4" Wall Testing

2. Based on 19 mil Design Thickness

3. Fiberglass or ROCKWOOL™ stone wool insulation is acceptable

3 5/8" Wall with 1x1 Application

6" Wall with 1x1 Application

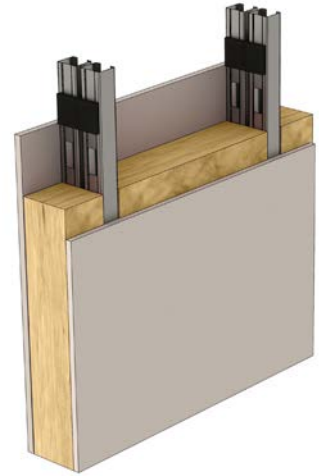
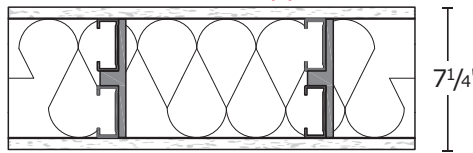
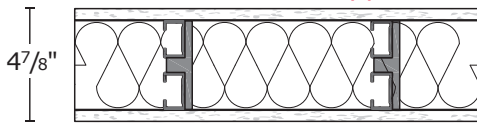

### Unbalanced 5/8" Type X GWB 2x1 Application

Wall Size	Application	STC Rating		Conventional Partition Range
		16" o.c. <sup>2</sup>	24" o.c. <sup>1</sup>	
3 5/8" Wall	2 - 1 5/8" Studs, Single GWB one side, Double GWB other side, 3-1/2" insulation batts	54	57	55-59
4" Wall	2 - 1 5/8" Studs, Single GWB one side, Double GWB other side, 3-1/2" insulation batts	54	57	
6" Wall	2 - 2 1/2" Studs, Single GWB one side, Double GWB other side, 6-1/2" insulation batts	56	57	

1. Based on 4" Wall Testing

2. Based on 19 mil Design Thickness

3. Fiberglass or ROCKWOOL™ stone wool insulation is acceptable

3 5/8" Wall with 2x1 Application

6" Wall with 2x1 Application

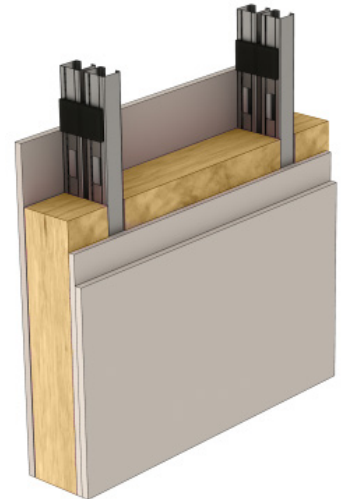
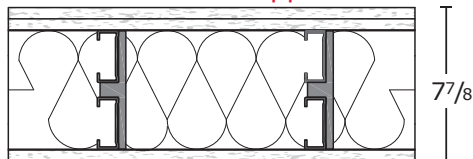
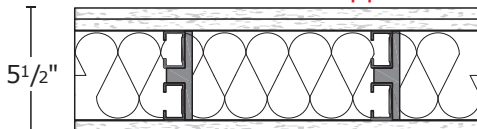

### Double Layer 5/8" Type X GWB 2x2 Application

Wall Size	Application	STC Rating		Conventional Partition Range
		16" o.c. <sup>2</sup>	24" o.c. <sup>1</sup>	
3 5/8" Wall	2 - 1 5/8" Studs, Double GWB each side, 3-1/2" insulation batts	57	60	60-64
4" Wall	2 - 1 5/8" Studs, Double GWB each side, 3-1/2" insulation batts	57	60	
6" Wall	2 - 2 1/2" Studs, Double GWB each side, 6-1/2" insulation batts	60	60	

1. Based on 4" Wall Testing

2. Based on 19 mil Design Thickness

3. Fiberglass or ROCKWOOL™ stone wool insulation is acceptable

3 5/8" Wall with 2x2 Application

6" Wall with 2x2 Application

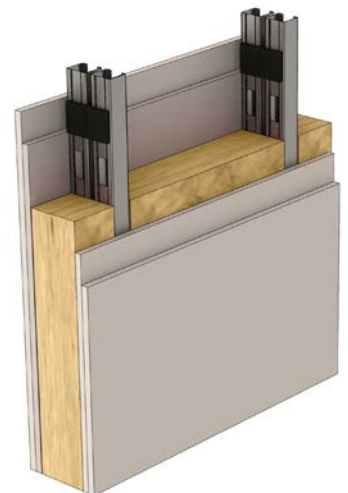
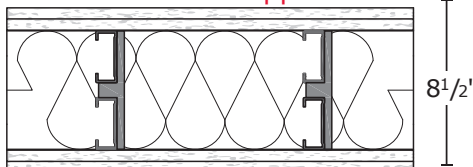
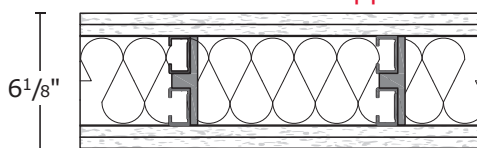

**Features and Benefits**

- 2¾" Gap to Allow for Pipes and Electrical Conduit Lines
- Only Available in 6" "SGPW" SoundGuard Studs
- UL Certified - UL V463, W475
- STC Tested
- Solves Framing Issues with Conduits and Pipes

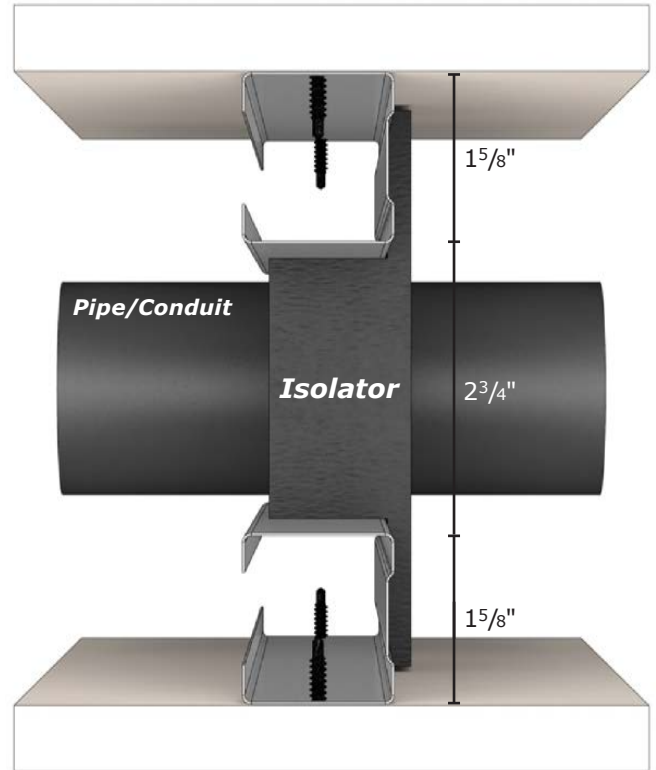
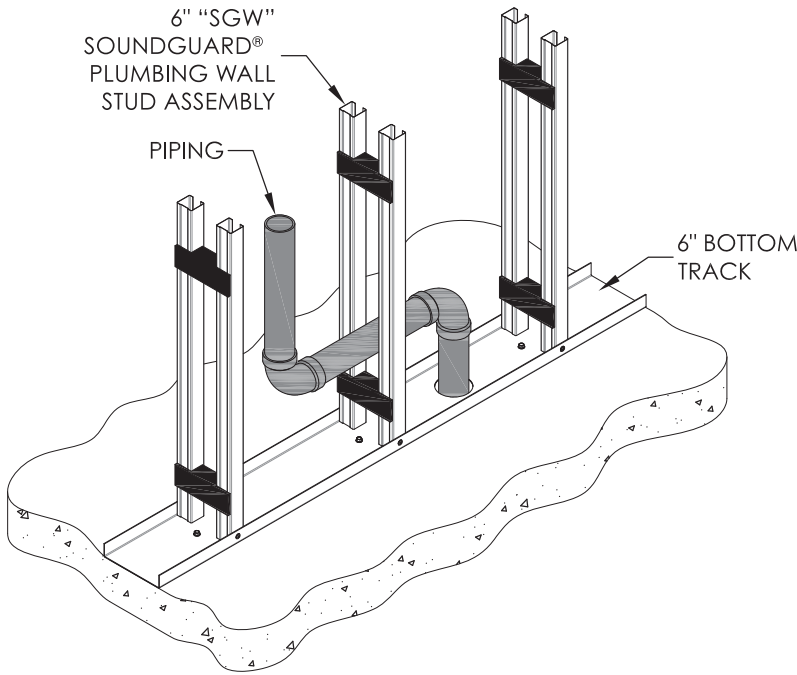

**Composite Limiting Heights**

MEMBER DESIGNATION	Stud Spacing (in. o.c.)	Design Thickness (in.)	F <sub>y</sub> (ksi)	5 psf			7.5 psf			10 psf		
				L/120	L/240	L/360	L/120	L/240	L/360	L/120	L/240	L/360
600SGPW162-18	12	0.0190	70	17' 1"	13' 6"	11' 10"	14' 11"	11' 10"	9' 10"	13' 6"	10' 5"	8' 8"
	16	0.0190	70	15' 6"	12' 4"	10' 5"	13' 6"	10' 5"	8' 8"	12' 4"	9' 1"	-
	24	0.0190	70	13' 6"	10' 5"	8' 8"	11' 10"	8' 8"	-	10' 5"	-	-
600SGPW162-30	12	0.0312	40	18' 3"	14' 6"	12' 8"	15' 11"	12' 8"	10' 9"	14' 6"	11' 4"	9' 5"
	16	0.0312	40	16' 7"	13' 2"	11' 4"	14' 6"	11' 4"	9' 5"	13' 2"	10' 0"	-
	24	0.0312	40	14' 6"	11' 4"	9' 5"	12' 8"	9' 5"	-	11' 4"	-	-
600SGPW162-43	12	0.0451	40	19' 7"	15' 7"	13' 7"	17' 2"	13' 7"	11' 10"	15' 7"	12' 4"	10' 3"
	16	0.0451	40	17' 10"	14' 2"	12' 4"	15' 7"	12' 4"	10' 3"	14' 2"	10' 11"	8' 10"
	24	0.0451	40	15' 7"	12' 4"	10' 3"	13' 7"	10' 3"	8' 4"	12' 4"	8' 10"	-

**Table Notes**

1. Allowable composite limiting heights are calculated in accordance using ICC-ES AC 86-2012.
2. The 5/8" Type X gypsum board must be applied full height vertically to each stud flange and installed using minimum No. 6 Type S Drywall screws spaced a maximum of 12 inch on-center for studs at 24 inch spacing, and 16 inch on-center for studs at 16 inch and 12 inch spacing.
3. A screw is required from stud to each track flange.
4. For deflection conditions, slotted track is required at head-of-wall.

## Sound Rating Data 6" Plumbing Wall

### ★ Single Layer 5/8" Type X GWB 1x1 Application

Wall Size	Application	STC Rating 16" o.c.	Conventional Partition Range
6" Plumbing Wall	2-1 5/8" Studs, Single GWB each side, R-13 Insulation, 2 3/4" cavity	53	50-54

1. Based on 6" Wall Testing      2. Based on 19 mil Design Thickness      3. Fiberglass or ROCKWOOL™ stone wool insulation is acceptable

6" Wall with 1x1 Application

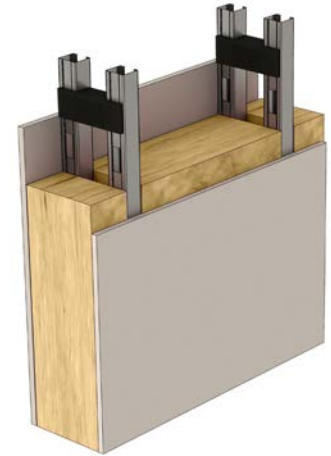
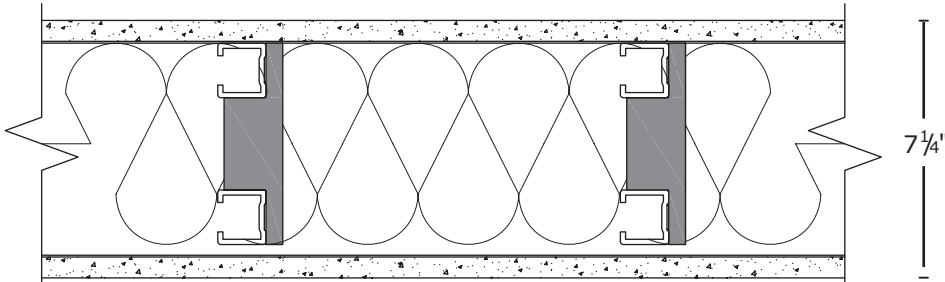

### ★ Unbalanced 5/8" Type X GWB 2x1 Application

Wall Size	Application	STC Rating 16" o.c.	Conventional Partition Range
6" Plumbing Wall	2-1 5/8" Studs, Single GWB one side, Double GWB other side, R-13 Insulation, 2 3/4" cavity	56	55-59

1. Based on 6" Wall Testing      2. Based on 19 mil Design Thickness      3. Fiberglass or ROCKWOOL™ stone wool insulation is acceptable

6" Wall with 2x1 Application

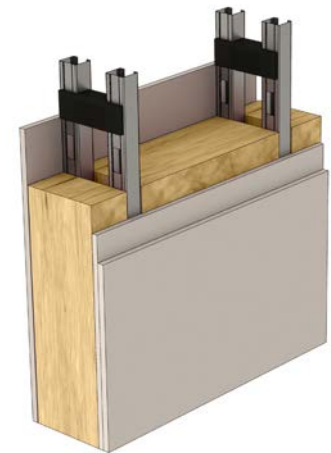
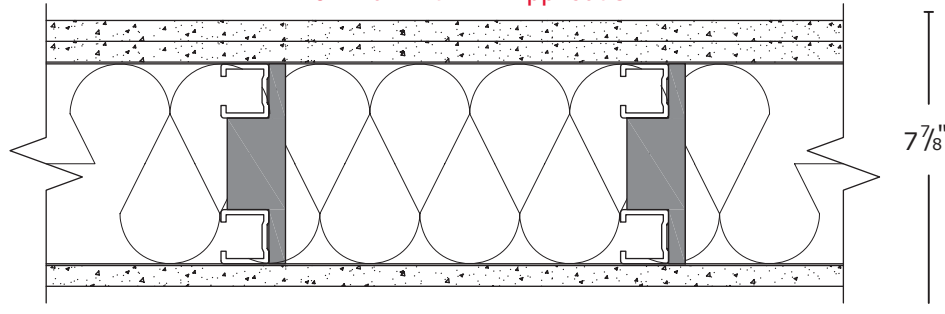

### ★ Double Layer 5/8" Type X GWB 2x2 Application

Wall Size	Application	STC Rating 16" o.c.	Conventional Partition Range
6" Plumbing Wall	2-1 5/8" Studs, Double GWB each side, R-13 Insulation, 2 3/4" cavity	60	60-64

1. Based on 6" Wall Testing      2. Based on 19 mil Design Thickness      3. Fiberglass or ROCKWOOL™ stone wool insulation is acceptable

6" Wall with 2x2 Application

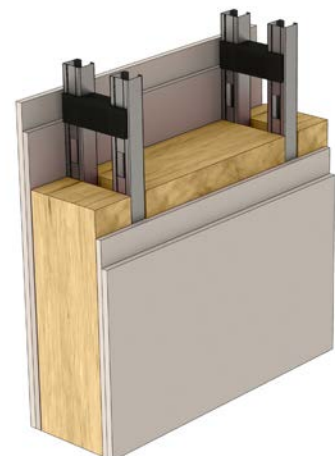
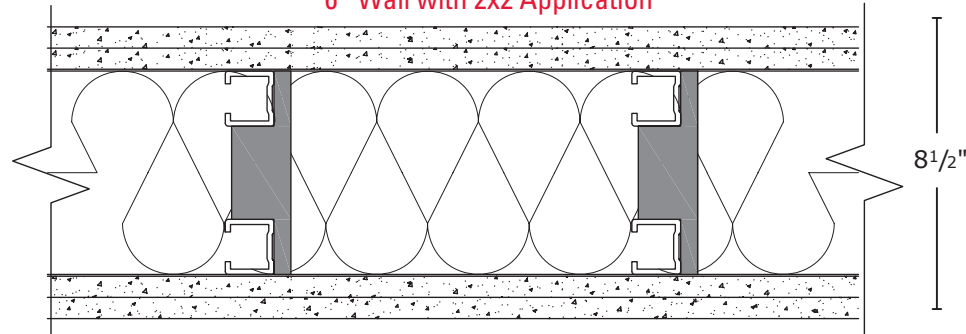

\*All heights represent interior loading conditions with a 5psf lateral pressure, and L/120 deflection criteria and 24" O.C.

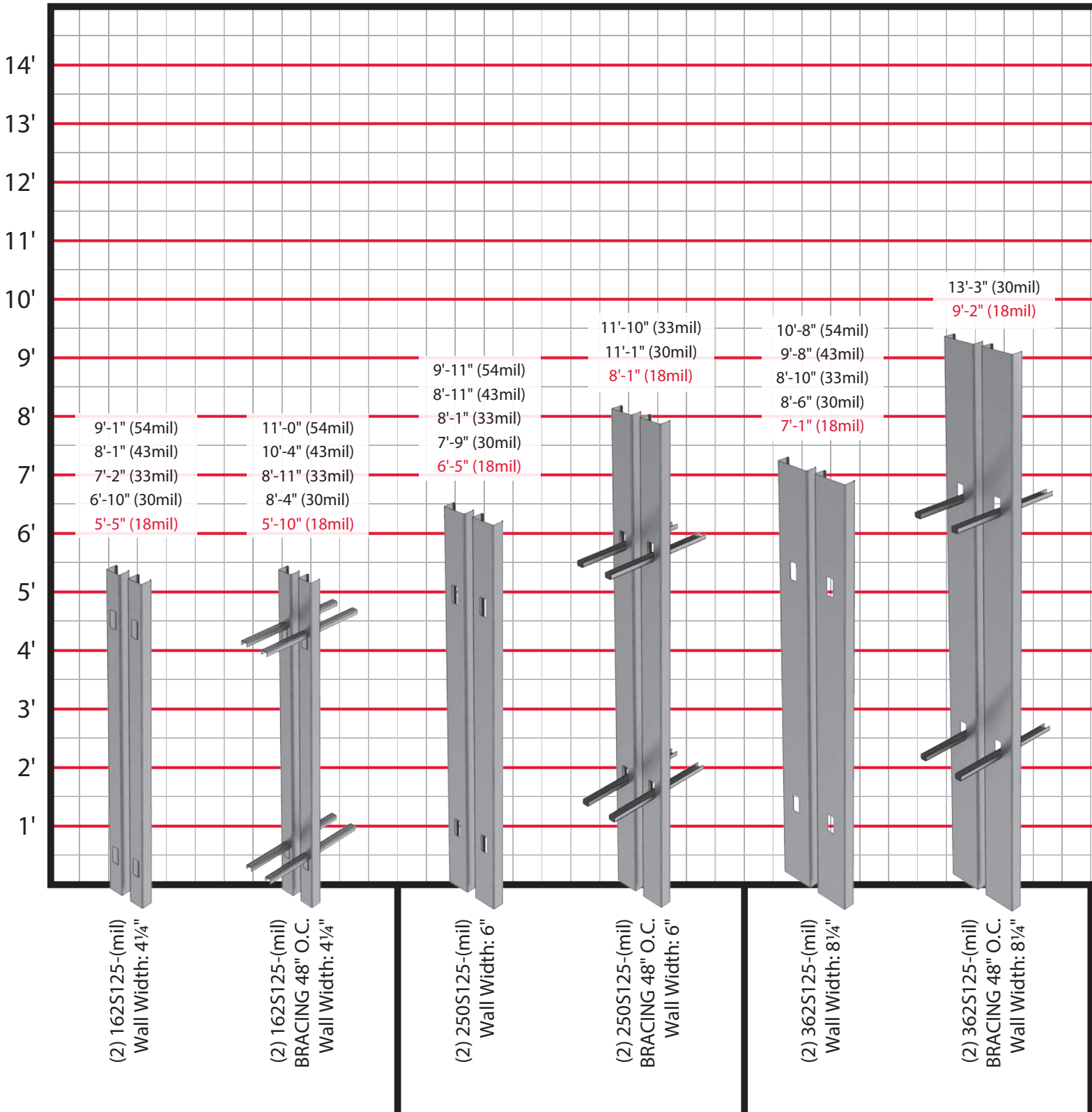

# CONVENTIONAL INSTALLATION



★ Tested and Certified Assemblies vs. Modified Assemblies

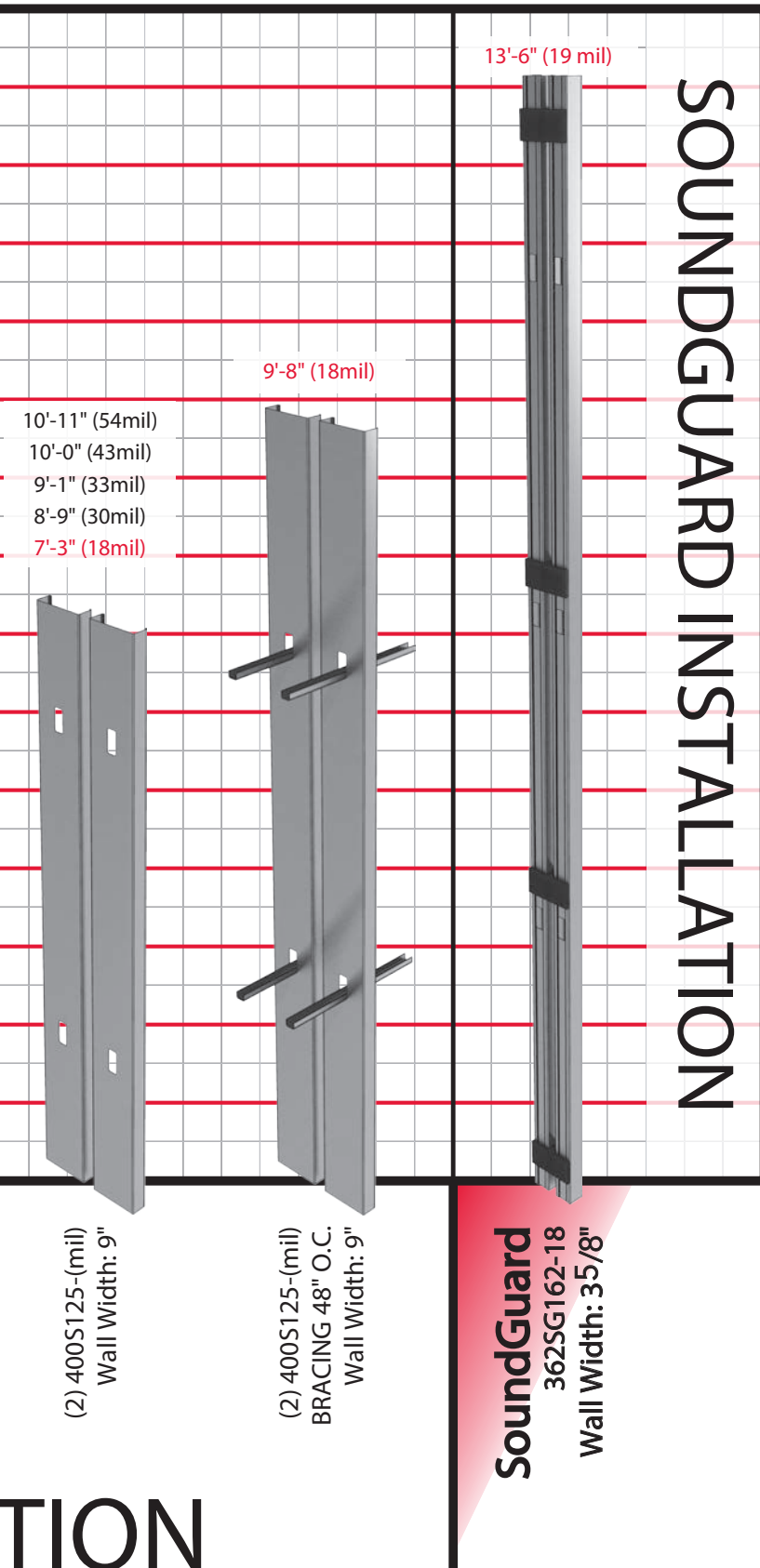

Steel stud walls will perform with superior sound transmission class (STC) ratings when they are constructed with thinner steel material. This will reduce the amount of paths that the soundwave vibrations can travel through the assembly. They are typically tested with 18mil (25 ga.) to maximize performance.

The allowable wall height of the members is often ignored while performing the sound tests. When constructing these walls in the field, the back flange is unsupported, resulting in low wall heights and limited design capabilities.

To reach specific wall heights, these sound rated assemblies are often altered by increasing the steel thickness or by installing lateral bracing (cold rolled channel), resulting in an assembly that is not equivalent to the tested sound wall design listed in published sound guides.

This chart depicts the maximum height for typical sound wall configurations. **SoundGuard provides substantially increased wall heights that well exceed conventional wall assemblies with the assurance of a lab tested STC rating.**

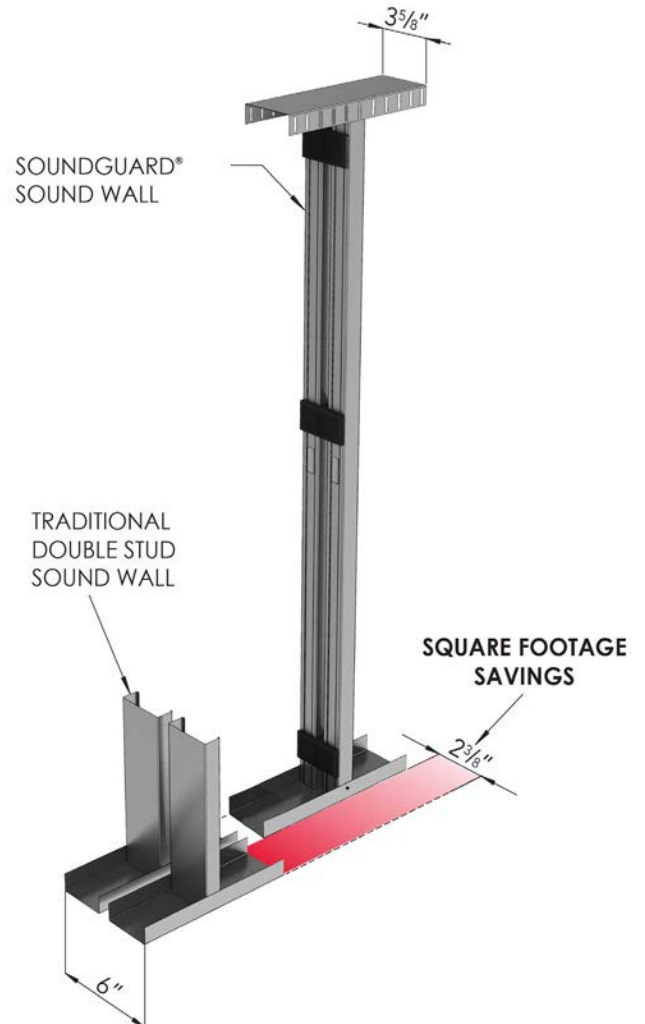

LEED® certified buildings save money and resources and have a positive impact on the health of occupants, while promoting renewable clean energy.

Utilizing SoundGuard® products on your project will assure the highest quality steel framing materials are used while helping your project attain LEED® Certification. The following information provides possible attainable credits based on the most current LEED® certification program.

**Applicable Credit Contributions:**

- 1. MRc2 – Construction Waste Management:** Marino\WARE Steel Studs and accessories are 100% recyclable and can contribute to Construction Waste Management Credits (MRc2).
- 2. MRc4 – Recycled Content:** Marino\WARE finished steel products contains a high average of a combined post and pre consumer recycled content that can contribute to Recycled Content Credits (MRc4).
- 3. MRc5 – Regional Materials:** Marino\WARE’s numerous source locations and manufacturing plants in the United States increase the possibility of qualifying for the Regional Materials Credits (MRc5). The number of attainable credits in this category is dependent on the distance of the project location to nearest Marino\WARE manufacturing facility.

**SoundGuard® Silent Framing System Applicable Credit Contributions:**

- 1. IEQc9 – Innovation:** Enhanced Acoustical Performance: Projects that fall in the Schools Category can qualify for an Indoor Environmental Quality Credit for Enhanced Acoustical Performance (IEQc9). Test results for the SoundGuard® Silent Framing System confirmed high levels of sound transmission reduction, with STC ratings as high as 60.
- 2. IDc1 – Innovation in Design:** Utilizing SoundGuard® and the ViperStud Framing System for your project can significantly reduce the quantifiable amount of material used, resulting in lower cost as well as contributing to the Innovation in Design Credit (IDc1).



**Resilient Channel Sandwiching Major Acoustic Concerns:**

Resilient Channel is often times used in conjunction with plywood shear panels or with backing boards and materials for the installation of cabinets or shelves. In this process the plywood or other materials are attached to the wall studs in parallel with the RC Channel, and then gypsum wall board (GWB) is attached to the face of the RC Channel and plywood. This type of construction is known as RC 'Sandwich' Installation, and is seen as a major construction error.

- Backing Creates an Acoustic Short Circuit
- RC Channel Is Ineffective
- Acousticians Agree that it Will Reduce the STC Rating
- Will Perform as a Regular Low Grade Acoustical Wall

Veneklasen Associates is one of the few Consultants in Acoustics that has performed tests on RC 'Sandwich' Installation, and in their 2009 Inter-Noise Article, "Quantitative Comparisons of Resilient Channel Designs and Installation Methods," they stated:

*"This is a catastrophic construction technique from an acoustical perspective, virtually negating the value of the resilient channel over much of the frequency range.*

*...Of the common installation errors presented, installing the resilient channel over a solid surface ("sandwiched" resilient channel) is by far the most egregious, resulting in up to 20 dB reduction in performance."*

**Veneklasen Associates**



✦ **'Sandwiched' Resilient Channel**

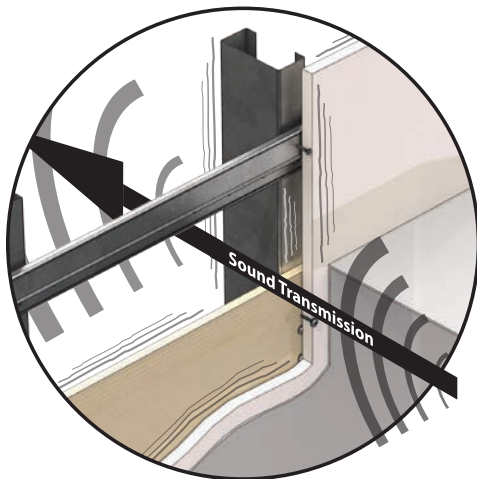

*Backing board renders the RC Channel ineffective.*

✦ **SoundGuard Solution**

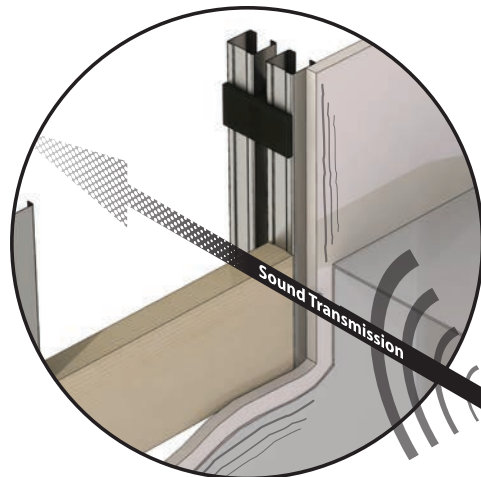

*SoundGuard's Foam Isolators efficiently retain high STC ratings.*

**Framing Solution for Wall-Hung-Items**

SoundGuard stud can accommodate lightweight wall attachments. Please contact our Technical Services Department for assistance in attaching cabinets, grab bars, etc. to SoundGuard

## SoundGuard

### Wall Junction Detail

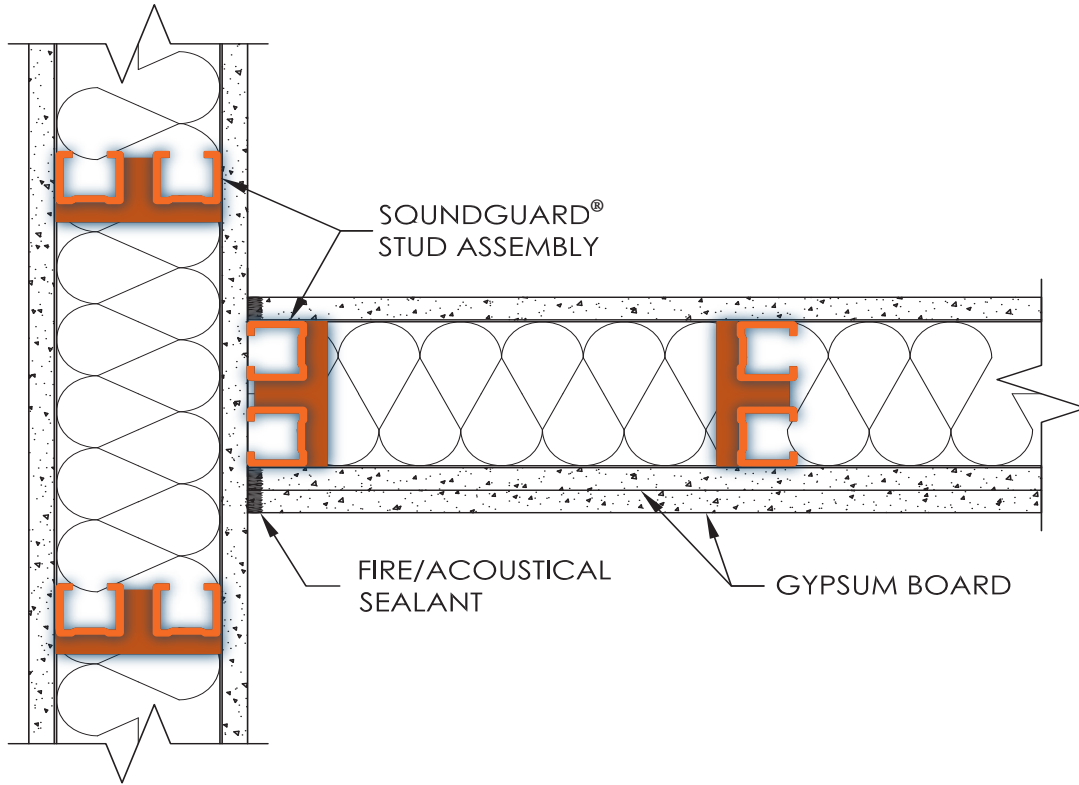

### Outside Corner Detail

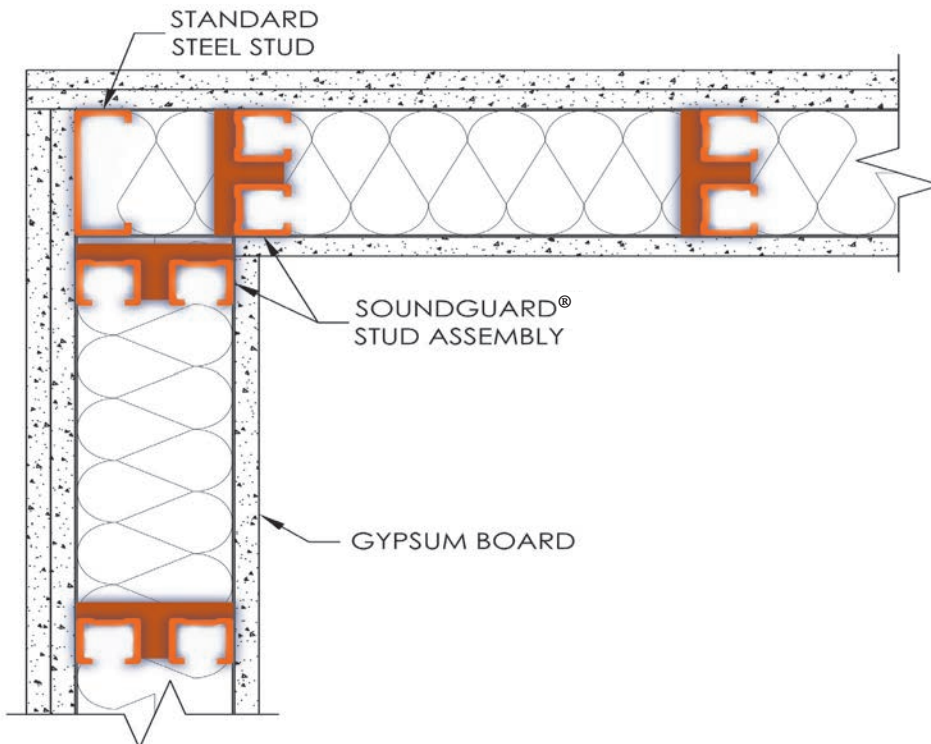

## SoundGuard

### ✦ Jamb Stud Detail

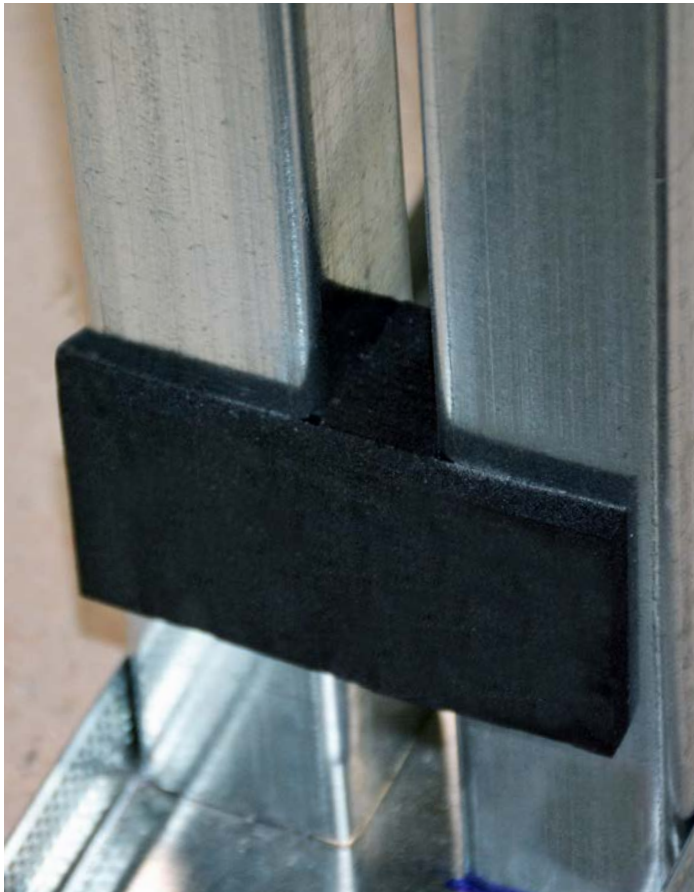
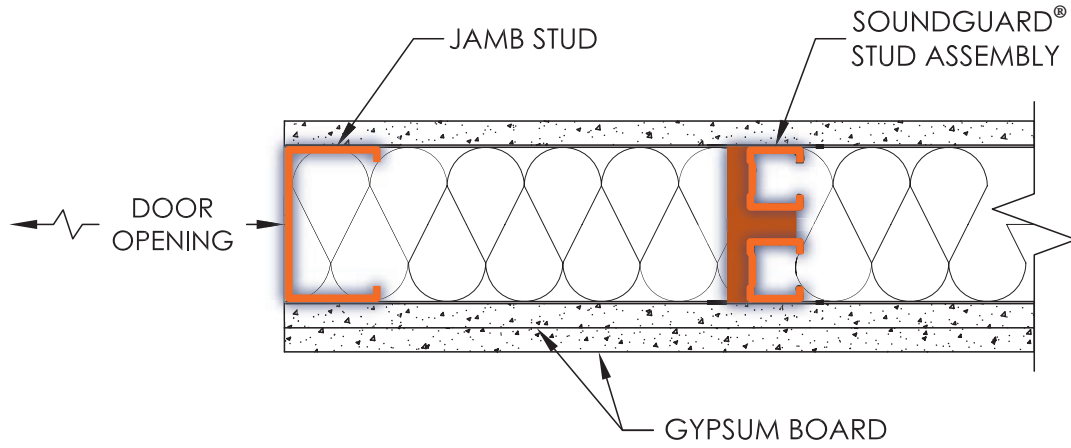

Non Load Bearing / 24" O.C. / 5/8" Type X

✦ **Wall Partition & Assembly**

- WP-1052 STC 50-54

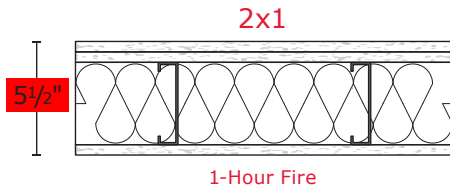

✦ **SoundGuard®**

- STC 52
- Less Drywall - 1 Layer GWB

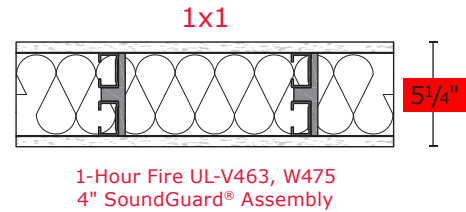

✦ **Wall Partition & Assembly**

- WP-1049 STC 50-54

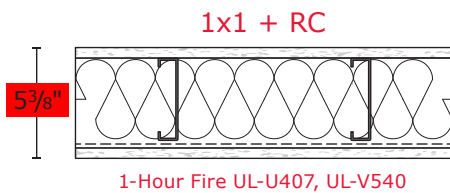

✦ **SoundGuard®**

- STC 52
- No Resilient Sound Channel Required

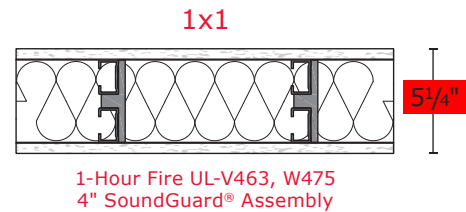

✦ **Wall Partition & Assembly**

- WP-1450 STC 60-64

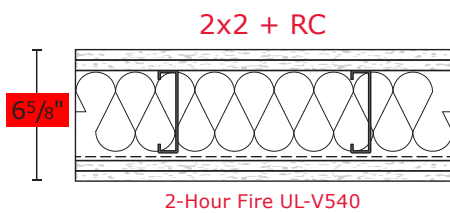

✦ **SoundGuard®**

- STC 60
- No Resilient Sound Channel Required

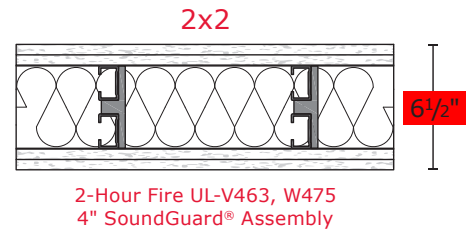

**Wall Partition & Assembly**

- WP-1451 STC 60-64

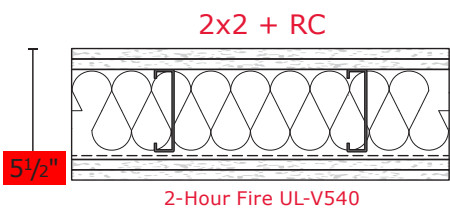

✦ **SoundGuard®**

- STC 60
- No Resilient Sound Channel Required

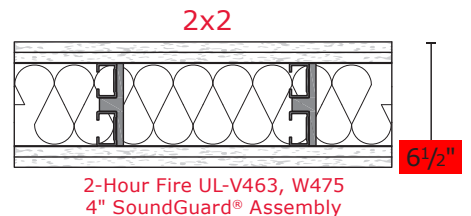

Non Load Bearing / 24" O.C. / 5/8" Type X

## ✦ Chase Wall Assembly

- WP-5015 STC 50-54

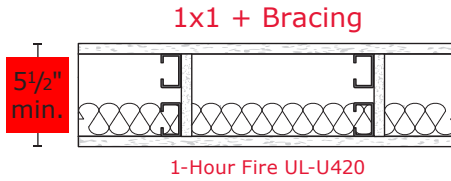

## ✦ SoundGuard®

- STC 52
- Eliminate One Wall (Stud + Track)
- No Cross Bracing, No CRC

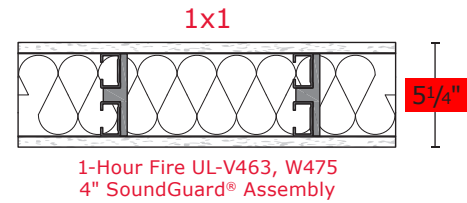

## ✦ Chase Wall Assembly

- WP-5017 STC 50-54

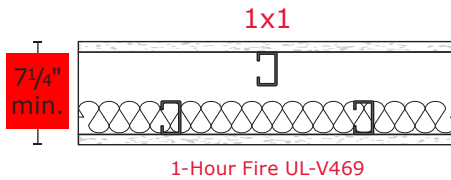

## ✦ SoundGuard®

- STC 52
- Eliminate One Wall (Stud + Track)
- Narrower Wall\* 1x1

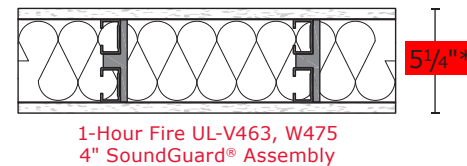

## ✦ Chase Wall Assembly

- WP-5071 STC 60-64

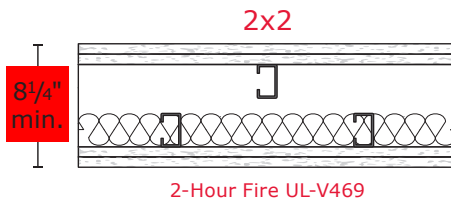

## ✦ SoundGuard®

- STC 60
- Eliminate One Wall (Stud + Track)
- Narrower Wall\*

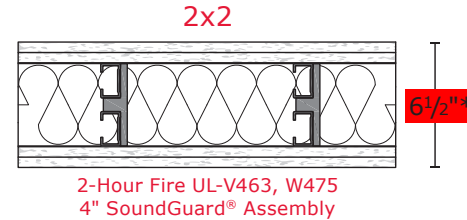

## ✦ Chase Wall Assembly

- WP-5105 STC 55-59

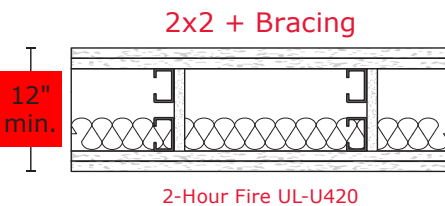

## ✦ SoundGuard®

- STC 60
- Eliminate One Wall (Stud + Track)
- No Cross Bracing, No CRC
- Narrower Wall\* 2x2

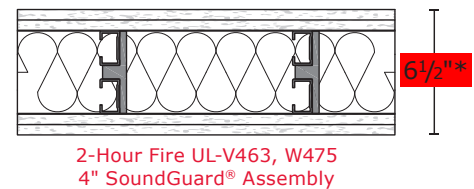

\*SoundGuard® Narrower Wall = More Saleable Square Footage

## **YOUR SUCCESS DEPENDS ON QUALITY BUILDING PRODUCTS AND SO DOES OURS.**

For over 30 years, Marino\WARE®, a division of Ware Industries, has provided customers with top quality cold-formed steel framing products. We are committed to providing a superior customer experience through a vast selection of readily available products, a knowledgeable sales team, comprehensive technical support and services, prompt delivery through our fleet of trucks, and an extensive distribution network.

Our best-in-class product development team delivers innovative solutions to installation and cost challenges with products designed to save time, labor, and materials. In addition, we utilize the latest in roll forming techniques, maintain the latest level of technology available to the steel framing industry, and strictly adhere to all ASTM specifications.

Marino\WARE is 100% American-owned and operated. We take pride in creating local jobs, supporting local communities, and manufacturing products that reflect the uncompromising skill and ethics of our professional team. We operate state-of-the-art production facilities in New Jersey, Georgia, and Indiana, as well as a sales office in New York.

Visit [MarinoWARE.com](http://MarinoWARE.com) to experience our full line of innovative solutions.

**For more information, please contact MarinoWARE® Technical Services at 866.545.1545**

This technical information reflects the most current information available and supersedes any and all previous publications effective September 28, 2023 | MW SoundGuard Catalog | ©WARE Industries, Inc. 2023

MarinoWARE® operates state-of-the-art production facilities in New Jersey, Georgia, and Indiana, as well as a sales office in New York.

#### **New Jersey Facility**

400 Metuchen Road  
South Plainfield, NJ 07080  
800.627.4661  
908.757.9000  
Fax: 908.412.1442

#### **Georgia Facility**

777 Greenbelt Parkway  
Griffin, GA 30223  
800.504.8199  
678.688.1312  
Fax: 678.688.1379

#### **Indiana Facility**

4245 Railroad Avenue  
East Chicago, IN 46312  
866.636.6002  
219.378.7100  
Fax: 219.378.7106

#### **New York Sales Office**

51 John St. Ste. 1  
Babylon, NY 11702  
800.627.4667  
631.691.2200  
Fax: 631.691.1492

#### **MarinoWARE® DesignGroup™**

100 Hendrick Drive, Suite 200  
McDonough, GA 30253  
866.545.1545  
678.688.7780  
Fax: 770.507.2605