

Marino\WARE® Product Submittal Data

PRODUCT NAME: 6 X 6 UTILITY ANGLE

MARINO\WARE PART # 600CJ18

PROPERTIES:

Leg A (in)	6	Yield Strength Fy (KSI)	33
Leg B (in)	6	Tensile Strength Fu (KSI)	45
Mils	43	Design Thickness (in)	0.0451
Available Finish	G40, G60, G90	Minimum Thickness (in)	0.0428
		Gauge	18

SECTION PROPERTIES

GROSS SECTION PROPERTIES

Cross Sectional Area: A (in ²)	0.5374
Weight of Member: (lb/ft)	1.8270
Moment of Inertia: I_x (in ⁴)	3.2108
Section Modulus: S_{x-t} (in ³)	0.7568
Section Modulus: S_{x-b} (in ³)	0.7568
Gross Section Modulus: S_{y-l} (in ³)	0.3776
Gross Section Modulus: S_{y-r} (in ³)	0.3744
Gross Moment of Inertia: I_y (in ⁴)	0.7945

05.40.00 Cold-Formed Metal Framing

UTILITY ANGLE-10'

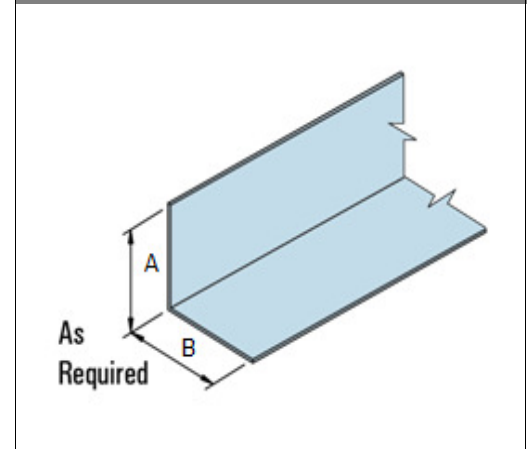

CODES & STANDARDS

- AISI S100, IBC 20105, 2018, 2021 compliant
- ASTM C955 & AISI S240 (33 mil - 118 mil)
- ASTM C645 & AISI S220 (18 mil - 33 mil)
- Galvanized steel sheet meets ASTM A1003 or A653

GREEN INFO

- LEED credits available
- Contact Technical Services for more information.