

Issue Date: 04-25-2014
Revision Date: 05-20-2024
Renewal Date: 04-30-2025

DIVISION: 09 00 00 – FINISHES

Section: 09 22 00 – Supports for Plaster and Gypsum Board

Section: 09 22 16 – Non-Structural Metal Framing

REPORT HOLDER:

ClarkDietrich Building Systems, LLC
9050 Centre Pointe Drive, Suite 400
West Chester, OH 45069
(888) 437-3244
www.clarkdietrich.com

ADDITIONAL LISTEES:

MBA Building Supplies
2200 Tempel Drive
Libertyville, Illinois 60048
(847) 680-7773
www.mbastuds.com

REPORT SUBJECT:

ProSTUD® Cold-Formed Steel Studs
ProTRAK® Cold-Formed Steel Tracks

1.0 SCOPE OF EVALUATION

1.1 This Research Report addresses compliance with the following Codes:

- 2024, 2021 and 2018 *International Building Code*® (IBC)
- 2024, 2021 and 2018 *International Residential Code*® (IRC)
- 2023 and 2020 *Florida Building Code - Building* (FBC-B) (see Section 9)
- 2023 and 2020 *Florida Building Code - Residential* (FBC-R) (see Section 9)
- 2022 *California Building Code* (CBC) (see Section 9)
- 2022 *California Residential Code* (CRC) (see Section 9)

NOTE: This report references 2024 IBC and IRC Code sections with [FBC and CBC] Code sections shown in brackets where they differ.

1.2 ProSTUD and ProTRAK have been evaluated for the following properties:

- Structural
- Acoustical
- Fire Resistance

1.3 ProSTUD and ProTRAK have been evaluated for use as interior nonload-bearing (nonstructural), gypsum board sheathed walls and ceilings in compliance with Sections 2204.1 [2210.1] and 2508 of the IBC, FBC-B, and CBC, and Sections R603 and R702.3 of the IRC, FBC-R, and CRC.

2.0 STATEMENT OF COMPLIANCE

ProSTUD and ProTRAK comply with the Codes listed in Section 1.1, for the properties stated in Section 1.2 and uses stated in Section 1.3, when installed as described in this report, including the Conditions of Use stated in Section 6.0.

2.1 2024 IBC and IRC Evaluation Reports

The Intertek CCRR is an *Evaluation Report* for approval of an alternate material, design, or method of construction in accordance with Section 104.2.3.6.1 of the 2024 IBC and Section R104.2.2.6.1 of the 2024 IRC.

3.0 DESCRIPTION

3.1 General – ProSTUD steel framing members are “C” shaped members with three evenly spaced grooves in each flange. ProSTUD members have offsets in the web, and diamond embosses on the center of the web of 2-1/2” and deeper members. The flanges of the ProSTUD members may be formed with or without knurling. ProTRAK steel framing members are “U” shaped members without a flange stiffener. ProTRAK members may be formed with or without two evenly spaced grooves in each flange and the flanges may be formed with or without a hem. ProTRAK members may be formed with or without a web offset or the diamond emboss. The flanges of ProSTUD and ProTRAK members may be formed with or without knurling. See Figures 1-3. The ProSTUD framing system products that are recognized in this



report are limited to the products whose designations are found in Table 2.

3.2 ProSTUD and ProTRAK framing members (studs and tracks) are fabricated from steel coil conforming to the mechanical and chemical properties of ASTM A1003. Steel grades for each ProSTUD and ProTRAK framing member designations and specifications are recognized. See Table 2. The ProSTUD and ProTRAK members have a protective coating which conforms to AISI S220 [ASTM C645 for FBC and CBC] and have a protective coating conforming to Specification A653/A653M–G40.

3.2.1 ProSTUD and ProTRAK members produced by ClarkDietrich Building Systems may also have a protective coating which provides an equivalent corrosion resistance to a G40 coating. ProSTUD and ProTRAK members equivalent corrosion resistance coatings are designated G40EQ or G40EQ DiamondPlus™.

3.3 ProSTUD is available in steel design thicknesses of 0.0158," 0.0190," 0.0200," 0.0232," 0.0312," and 0.0346." The framing members are available in depths of 1-5/8", 2-1/2", 3-1/2", 3-5/8", 4", 5-1/2" and 6". The 18-mil ProSTUD is not recognized for 3-1/2" and 5-1/2" depths. See Figure 1 for stud profiles and Table 2 for recognized product designations.

3.4 ProTRAK thickness corresponds to the stud thicknesses. See Figure 3 for track profiles and Table 2 for recognized product designations.

3.5 ProSTUD is pre-punched with knockouts spaced every 48 inches throughout the stud length and shall not be located less than 10 inches from the end of the member to the near edge of the web knockout. Punch-out hole dimensions are as indicated in Figure 4 for each stud depth.

3.6 Fasteners for attachment of gypsum wall board to framing shall be a minimum #6 Type S drywall screws complying with SAE J78 and ASTM C1002. Fasteners are spaced a maximum of 16 inches on center for 16 in. or 12 in. stud spacing; and 12 inches on center for 24 in. stud spacing.

3.7 Gypsum wallboard for composite assemblies shall comply with ASTM C1396 and be 5/8" thick Type X gypsum, manufactured by American, CertainTeed, Georgia Pacific, Continental, National, PABCO, or United States Gypsum.

4.0 PERFORMANCE CHARACTERISTICS

4.1 Reference the ClarkDietrich Building Systems ProSTUD Product Catalog with effective date of 1/3/24 (attached) for design capacities, where only the following pages are within the scope of this report:

4.1.1 ProSTUD and ProTRAK Section Properties on pages 6-9.

4.1.2 ProSTUD and ProTRAK Screw Connection Values on page 25.

4.1.3 ProSTUD Composite Limiting Height tables and instructions on pages 10, and 16-17. When composite limiting heights are used the interior nonload-bearing wall assemblies shall be limited to interior installations where the superimposed axial load is zero pounds.

4.1.4 ProSTUD 15-mil width 3-5/8", 4" and 6" and 18-mil width 2-1/2", 3-5/8", 4" and 6" Composite Limiting Height tables that use MaxTRAK are found on pages 12-13. MaxTRAK deflection tracks are referenced in CCRR-0205. These tables are limited to ClarkDietrich Building Systems only and not the listees of this CCRR.

4.1.5 ProSTUD 15-mil width 3-5/8", 4" and 6" and 18-mil width 2-1/2", 3-5/8", 4" and 6" Composite Limiting Height tables that use standard deflection track are found on pages 14-15. Standard deflection tracks are referenced in CCRR-0206. These tables are limited to ClarkDietrich Building Systems only and not the listees of this CCRR.

4.1.6 ProSTUD Non-Composite Limiting Height tables on pages 18-19. Per AISI S220 nonstructural wall studs manufactured from steel with a minimum measured thickness of 0.0179" (18 mil) may have a superimposed vertical load, exclusive of sheathing materials, not exceeding 100 lb/ft, or a superimposed vertical load not exceeding 200 lbs. per stud.

4.1.7 ProSTUD Sound Assemblies identified in the tables on pages 20-21 provide the Sound Transmission Class (STC) required for air-borne sound according to IBC Section 1206.2 [1207.2 for FBC and CBC] and IRC Section AK102 where STC ratings are not less than 50 and 45, respectively.





4.1.8 ProSTUD Fire Rated Assemblies identified in the tables on page 22. ProSTUD and ProTRAK framing meet requirements for use in fire-resistance rated assemblies in accordance with IBC, FBC and CBC Section 703.2 when used in accordance with UL Certification CIKV.R26512 and related UL Design Nos.

4.1.9 ProSTUD Allowable Ceiling Span tables on page 24.

4.2 For construction governed by the FBC High Velocity Hurricane Zone (HVHZ), the wall height is limited to the height at the L/240 deflection level.

4.3 Non-loadbearing (nonstructural) wall heights are determined by the lesser of the limiting conditions which include wall deflection, shear strength, web crippling strength, or flexural strength of the stud.

5.0 INSTALLATION

5.1 ProSTUD and ProTRAK must be installed in accordance with the manufacturer's published installation instructions, the applicable Code, and this Research Report. A copy of the manufacturer's instructions must be available on the jobsite during installation.

5.2 Framing shall be in accordance with the code requirements, AISI S220-20 [AISI S220-15] and ASTM C754.

5.3 Fire rated assemblies shall be in accordance with the applicable UL Design No. from UL Certification CIKV.R26512.

5.4 Sound rated assemblies shall be in accordance with the wall assembly description given in the sound transmission test report correlating with the sound assembly from pages 21 in the attached product catalog.

6.0 CONDITIONS OF USE

6.1 Installation must comply with this Research Report, the manufacturer's published installation instructions, and the applicable Code. In the event of a conflict, this report governs.

6.2 All designs and calculations shall be prepared by a licensed design professional according to the requirements in the jurisdiction where the project is located.

6.3 Jobsite manufacturing of studs or tracks is outside the scope of this report.

6.4 The minimum base steel thickness of the section delivered to the jobsite must be a minimum of 95% of the design thickness.

6.5 The ProSTUD and ProTRAK Framing identified in this report is manufactured in accordance with the manufacturer's approved quality control system with inspections by Intertek.

7.0 SUPPORTING EVIDENCE

7.1 Manufacturer's drawings and installation instructions.

7.2 Reports of testing and engineering analysis demonstrating compliance with AISI S220-20 [AISI S220-15], North American Standard for Cold-formed Steel Framing – Nonstructural Members.

7.3 Reports of evaluation and engineering analysis demonstrating compliance with AISI S100-16(2020) w/S2-20 [AISI S100-16], North American Specification for the Design of Cold-Formed Steel Structural Members.

7.4 Reports of testing and engineering analysis demonstrating compliance with ICC-ES AC46, Acceptance Criteria for Cold-Formed Steel Framing Members, October 2019 editorial revised December 2020.

7.5 Reports of testing and evaluation of G40EQ and G40EQ DiamondPlus coating to verify equivalent corrosion resistance to G40 coated specimens per the requirements of AISI 220-20 [ASTM S220-15].

7.6 Reports of acoustical testing in accordance with ASTM E90-04, Testing Standard for Air-Borne Sound Transmission Loss of Building Partitions and Elements.

7.7 Documentation of an Intertek approved quality control system for the manufacturing of products recognized in this report.





8.0 IDENTIFICATION

ProSTUD and ProTRAK produced in accordance with this report shall be identified with labeling at a maximum spacing of 96 inches that includes the following information:

- 8.1 The manufacturers name, logo, or initials;
- 8.2 The ProSTUD and ProTRAK framing designation;
- 8.3 Minimum base steel thickness (uncoated) in decimals or mils;
- 8.4 Yield strength;
- 8.5 Galvanization coating designation G40, G40EQ or G40EQ DiamondPlus.
- 8.6 The Intertek Code Compliance Research Report identification and number, "Intertek CCRR-0207"
- 8.7 ProSTUD and ProTRAK Framing to be used in fire-resistance rated assemblies shall be labeled in accordance with UL certification CIKV.R26512.
- 8.8 Bundles of like members shall be identified with the Intertek identification mark and Code Compliance Research Report number as shown:



9.0 ADDITIONAL CODES

9.1 FLORIDA BUILDING CODE

9.1.1 Scope of Evaluation: The ProSTUD and ProTRAK were evaluated for compliance with the 2020 and 2023 Florida Building Code – Building and Florida Building Code – Residential.

9.1.2 Conclusion: The ProSTUD and ProTRAK, described in Sections 2.0 through 7.0 of this Research Report, comply with the 2020 and 2023 Florida Building Code – Building and Florida Building Code – Residential, including the High-Velocity Hurricane Zone provisions.

9.2 CALIFORNIA BUILDING CODE

9.2.1 Scope of Evaluation: The ProSTUD and ProTRAK were evaluated for compliance with the 2022 California Building Code and California Residential Code.

9.2.2 Conclusion: The ProSTUD and ProTRAK, described in Sections 2.0 through 7.0 of this Research Report, comply with the 2022 California Building Code and California Residential Code.

10.0 CODE COMPLIANCE RESEARCH REPORT USE

10.1 Approval of building products and/or materials can only be granted by a building official having legal authority in the specific jurisdiction where approval is sought.

10.2 Code Compliance Research Reports shall not be used in any manner that implies an endorsement of the product by Intertek.

10.3 Reference to the <https://bpdirectory.intertek.com> is recommended to ascertain the current version and status of this report.

This Code Compliance Research Report ("Report") is for the exclusive use of Intertek's Client and is provided pursuant to the agreement between Intertek and its Client. Intertek's responsibility and liability are limited to the terms and conditions of the agreement. Intertek assumes no liability to any party, other than to the Client in accordance with the agreement, for any loss, expense or damage occasioned by the use of this Report. Only the Client is authorized to permit copying or distribution of this Report and then only in its entirety, and the Client shall not use the Report in a misleading manner. Client further agrees and understands that reliance upon the Report is limited to the representations made therein. The Report is not an endorsement or recommendation for use of the subject and/or product described herein. This Report is not the Intertek Listing Report covering the subject product and utilized for Intertek Certification and this Report does not represent authorization for the use of any Intertek certification marks. Any use of the Intertek name or one of its marks for the sale or advertisement of the tested material, product or service must first be approved in writing by Intertek.





TABLE 1 - CODE REFERENCED STANDARDS

2021 IBC	2018 IBC	2023 FBC	2020 FBC	2022 CBC
AISI S100-16(2020) w/S2-20 AISI S220-20	AISI S100-16 AISI S220-15	AISI S100-16(2020) w/S2-20 AISI S220-20	AISI S100-16 AISI S220-15	AISI S100-16(2020) w/S2-20 AISI S220-20

TABLE 2 - PROSTUD AND PROTRAK SPECIFICATIONS¹

ClarkDietrich Designation	Min. Base Steel Thickness	Min. Yield Strength (ksi)
ProSTUD 25	0.0150" (15-mil)	NS 50
ProSTUD 20 ²	0.0181 (18-mil)	NS 70
ProSTUD 20 LTD	0.0190" (19-mil)	NS 65
ProSTUD 22 MIL	0.0220" (22-mil)	NS 57
ProSTUD 30 MIL	0.0296" (30-mil)	NS 33
ProSTUD 33 MIL	0.0329" (33-mil)	NS 33
ProTRAK 25	0.0150" (15-mil)	NS 50
ProTRAK 20 ²	0.0181 (18-mil)	NS 50
ProTRAK 20 LTD	0.0190" (19-mil)	NS 50
ProTRAK 22 MIL	0.0220" (22-mil)	NS 50
ProTRAK 30 MIL	0.0296" (30-mil)	NS 33
ProTRAK 33 MIL	0.0329" (33-mil)	NS 33

¹ ProSTUD and ProTRAK are available in depths of 1-5/8", 2-1/2", 3-1/2", 3-5/8", 4", 5-1/2" and 6".

² 18-mil Pro Stud 20 and ProTRAK 20 are available in depths of 1-5/8", 2-1/2", 3-5/8", 4", and 6".

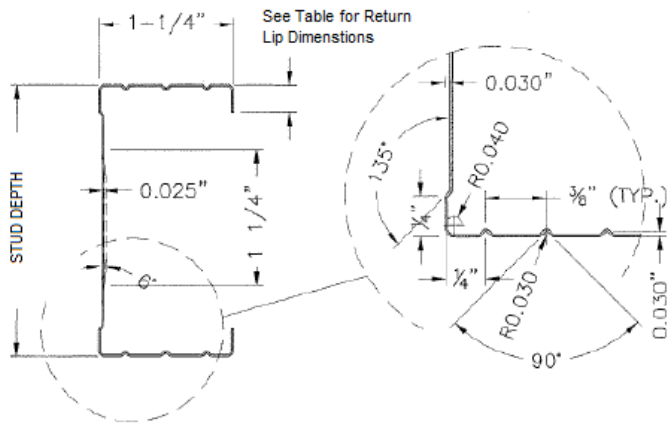

1-5/8" & 2-1/2" Studs

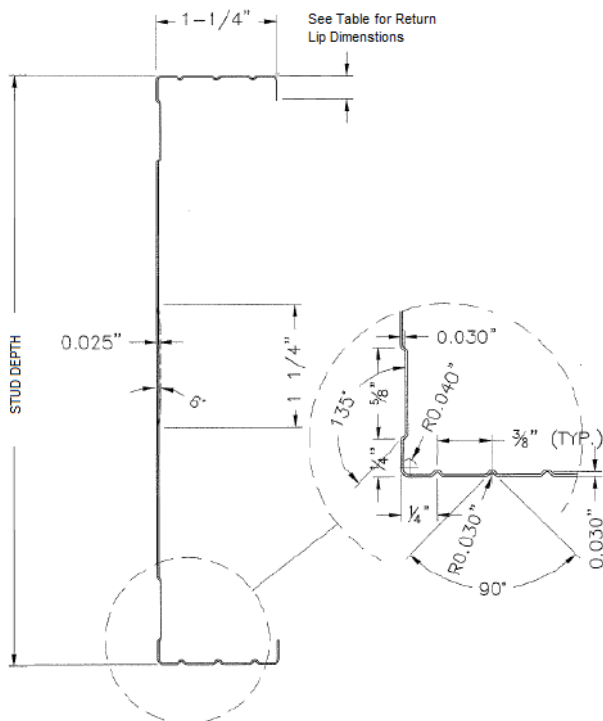

3-1/2\", 3-5/8\", 4\", 5-1/2\" & 6\" Studs

Return Lip Dimensions		
Section	Minimum Thickness	Return Lip
162S125	0.015"	0.250"
250S125		
350S125		
362S125		
400S125		
550S125		
600S125	0.0181"	0.275"
162S125		0.315"
250S125		0.325"
362S125		0.340"
400S125		0.386
600S125		0.019"
162S125	0.300"	
250S125	0.315"	
350S125	0.315	
362S125	0.330"	
400S125	0.350"	
550S125	0.360"	
600S125	0.022"	0.280"
162S125		0.315"
250S125		0.330"
350S125		0.330"
362S125		0.340"
400S125		0.360"
550S125	0.386"	
600S125	0.0296"	0.250"
162S125		
250S125		
350S125		
362S125		
400S125		
550S125	0.0329"	0.250"
600S125		
162S125		
250S125		

FIGURE 1 – PROSTUD SECTION PROFILES



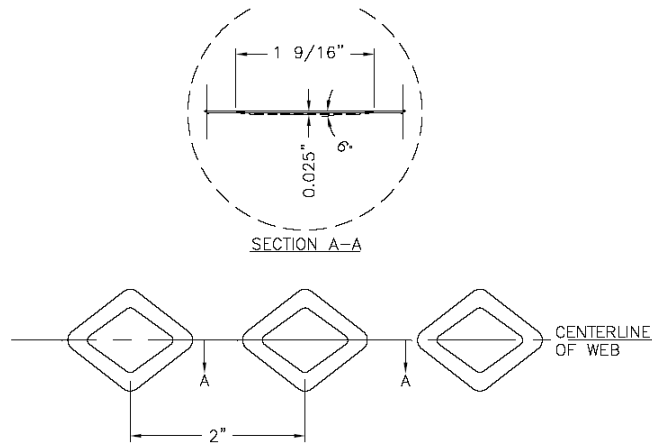

FIGURE 2 – WEB EMBOSSMENT DETAIL
(No embossment on 1-5/8" studs)

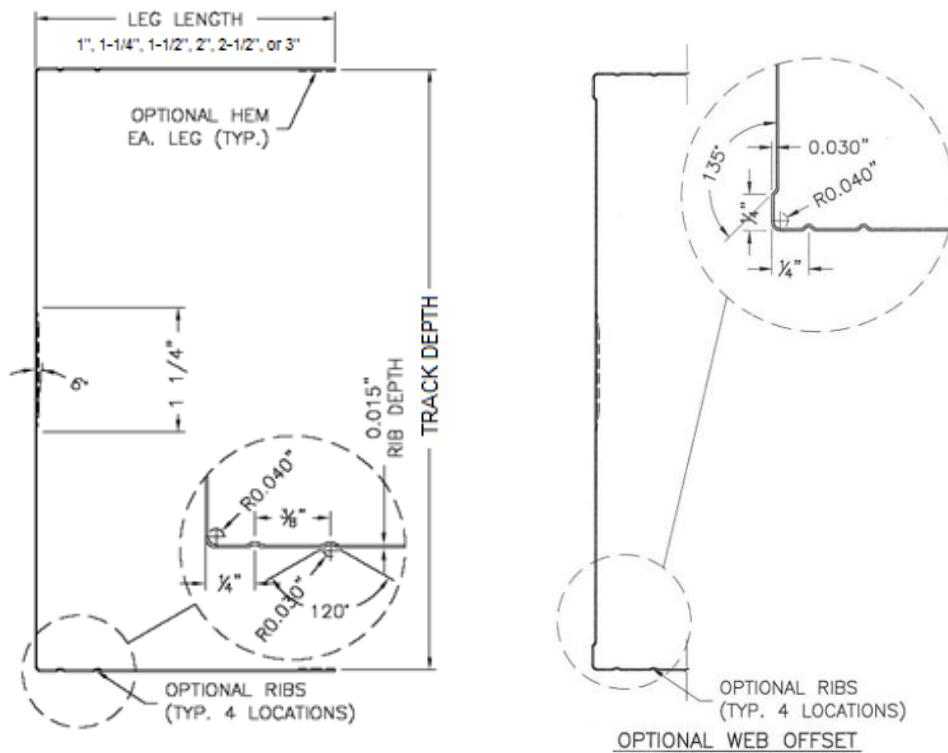
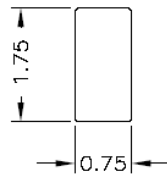
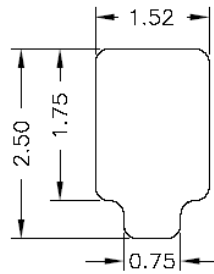

FIGURE 3 – PROTRAK SECTION PROFILE



HOLE PUNCH
IN STUD SIZES
1-5/8" TO 2-1/2"



HOLE PUNCH
IN STUD SIZES
3-1/2" TO 6"

FIGURE 4 – PUNCH-OUT HOLE DIMENSIONS



**STRONGER
THAN STEEL.™**

DRYWALL FRAMING SYSTEM

IN CONFORMANCE WITH: IBC 2024 • AISI S100 • AISI S220

ProSTUD® DRYWALL
FRAMING SYSTEM

ClarkDietrich.

WHERE INNOVATION
TAKES FORM.

The ProSTUD® Drywall Framing System with Smart Edge™ Technology can be called many things. Strong. Versatile. Fast. And without a doubt—revolutionary. But one of the biggest benefits to keep in mind is this: ProSTUD was developed, tested and approved by pros in the field who demanded nothing less than achieving absolute ease of use. Its performance has also been proven by the most extensive laboratory evaluations available. All of which means ProSTUD comes with complete confidence and no questions about code compliance. With the backing of online, mobile and data-rich BIM resources, there's no better example of a broader vision at work.

ProSTUD, in fact, is just one example of how ClarkDietrich can reinforce your efforts to design and build more intelligently. Yes, we're known as a manufacturer of extensively tested, code-compliant steel framing products, but we offer so much more. Our products perform as a system. We support a range of efforts for smarter installation and design.

We provide the expertise of a versatile engineering services team. And we do it all on a nationwide scale.

We've put together an incredible array of resources to help you be successful on any project, regardless of size or complexity. Within this catalog you'll discover the multiple advantages ProSTUD has to offer, as well as detailed information on the product lineup, limiting heights, sound and fire assemblies, and more.

Ultimately, your choice of ProSTUD doesn't come down to the integrity of the product alone, or even its ease of use. You're also looking to the strength of the company that stands behind it. Count on the expertise, services and full support of ClarkDietrich today—and far into the future.

TABLE OF CONTENTS

ProSTUD Drywall Framing System

Overview	4
Profile Information	5

Physical & Structural Properties

ProSTUD 25 (15mil)	6
ProSTUD 20 (18 mil)	7
ProSTUD 30MIL	8
ProSTUD 33MIL	9

Limiting Heights Overview

Head-of-Wall Composite	12-19
------------------------	-------

Full Composite Limiting Heights Tables

Non-Composite Limiting Heights Tables	20-21
---------------------------------------	-------

Sound Testing

Fire Testing	24-25
--------------	-------

UL® Listed Wall Assemblies	26
----------------------------	----

Connections

Deflection Track Systems	27
--------------------------	----

Ceiling Span Tables

Connections

Allowable Screw Design Values	28
-------------------------------	----

General

Collaborative Services	29
Code Approvals & Standards	30

Need Product Submittals?

Use **SubmittalPro®** at clarkdietrich.com.

What is an Equivalent (EQ) Drywall Stud?

Gauge equivalent drywall framing must meet the minimum performance requirements of conventional drywall framing as defined by the Steel Framing Industry Association (SFIA). The industry’s “EQ” product of choice, ProSTUD,[®] employs roll-forming and steel-making technology, exceeding the performance of conventional drywall framing for allowable moment and screw connection strength. When comparing drywall framing systems, it is important to keep in mind Life Safety, System Performance and Connections. The ProSTUD Drywall Framing System provides peace of mind for all three important functions by providing the right selection of products and product data for every application.

ProSTUD Drywall Framing		Conventional Drywall Framing	
ProSTUD 25	15mil	25 Gauge	18mil
ProSTUD 20	18mil	20 Gauge	30mil

Life Safety

Life Safety is the primary concern and duty of all construction and design professionals. For interior drywall framing members, bending strength is the criteria most important to the strength of a wall or ceiling. AISI defines bending or flexural strength by Allowable Moment. The corresponding chart compares the bending strength of ProSTUD and conventional drywall studs.

Allowable Bending Capacity, 3-5/8" Stud

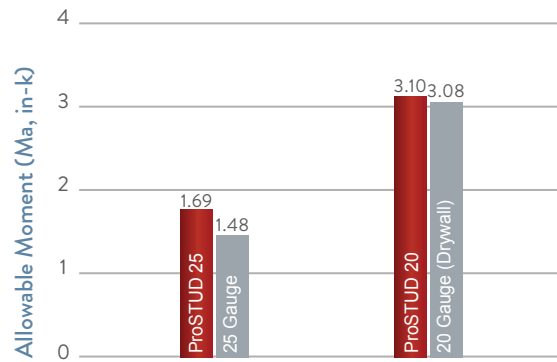

System Performance

Given ProSTUD’s strength and versatility, it’s important to know the performance of the ProSTUD member under your project’s specific criteria. This catalog will provide guidance in a variety of assemblies and loading criteria, based on current building codes. Additional data is available at clarkdietrich.com.

Connections

In addition to sufficient member strength, it’s important to know how connections will perform. Connections can be critical to the capacity and safety of an assembly, but they are also important for the attachment of cabinets, shelving, handrails, and other accessories to steel framing. The tables below compare the screw performance of ProSTUD to conventional drywall framing. This performance relationship to conventional studs can be applied to a variety of fasteners and connections.

#6 Screw Pullout Values

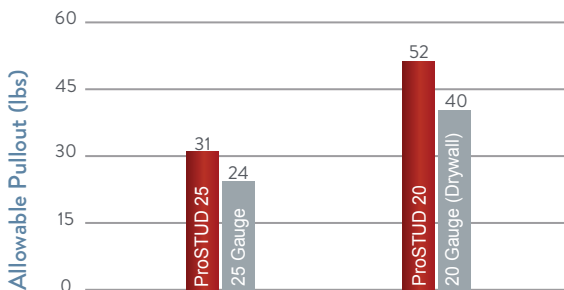

#6 Screw Shear (Bearing) Values

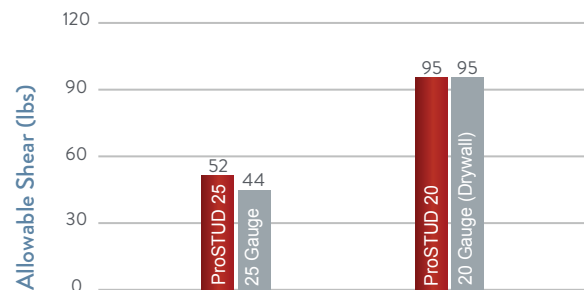

Along with connection capacity, conventional framing members are required to meet performance criteria for screw spinout. ProSTUD was developed with screw performance in mind. High-strength steel, flange stiffening grooves, web embossments, and knurling features combine to provide the best performance per thickness, exceeding the requirements of AISI S220.

Construction Advantages

- High-strength steel combined with low-profile flange stiffening grooves and double offset web planking increases strength and provides greater limiting heights
- Diamond-embossed web creates stiffness, reducing flange fade and screw spinout during drywall installation
- Strong, lightweight stud and track cuts and handles easier than conventional flat steel studs
- Flange grooves provide sight line for drywall alignment and aid in positioning screws at drywall joints to maintain the 3/8" edge requirement
- Web and leg enhancements in ProTRAK® provide straight and rigid legs, making it the best choice for framing walls, headers, soffits, and bulkheads

Design Advantages

- Designed to meet the additional strength requirements of today's building codes: IBC 2024, AISI S100, S220, S916 and ICC-ES AC46 and AC86
- Smart Edge™ Technology is an enhancement for producing easier-to-handle steel that reduces the risk of cuts and scrapes
- UL Classified and listed in over 50 designs, including U419, V438, and chase wall assemblies
- Exceptional sound performance in over 30 tested sound assemblies
- Can contribute LEED® points in LEED v4.1 or v4. EPD and HPD verifications also available.
- National availability

ProSTUD®

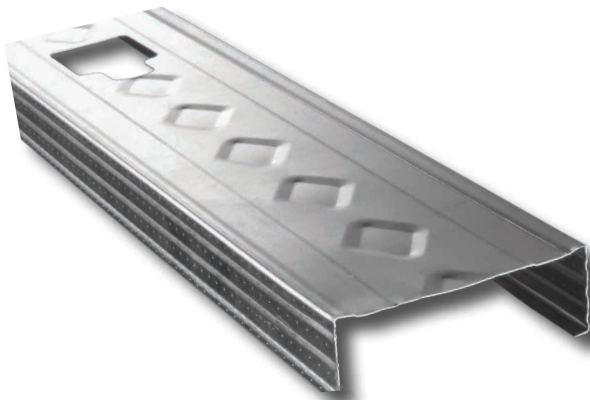

- Web Widths: 1-5/8," 2-1/2," 3-1/2," 3-5/8," 4," 5-1/2," and 6"
- Flange: 1-1/4"
- Return Lip: varies by stud size
- **Material Thicknesses:**
 ProSTUD 25 / 15mil (25ga EQ) 50ksi
 ProSTUD 20 / 18mil (20ga EQ) 70ksi
 ProSTUD 30MIL 33ksi
 ProSTUD 33MIL 33ksi
- G40EQ is standard, G40 available upon request.
- Other coatings available as special order: G40EQ DiamondPlus®, G60 and G90.
- G40EQ DiamondPlus® is only available in select markets and thicknesses. Contact your local sales representative for market availability.

ProSTUD Profile

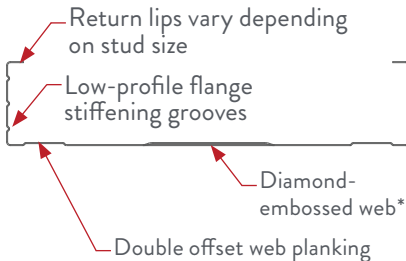

Shipping / Stacking



Double offset in web prevents flange locking of studs

Drywall Joint

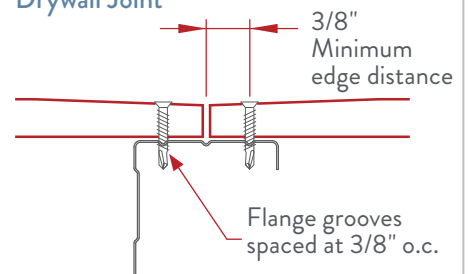

*Except in 1-5/8"

ProTRAK

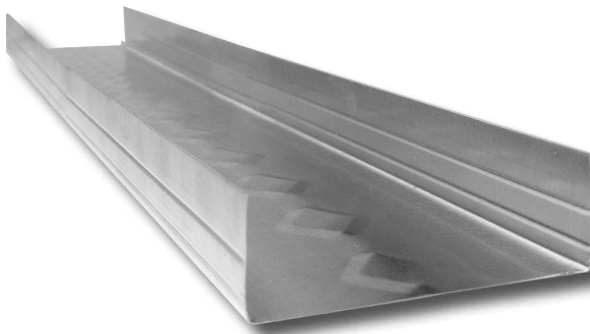

- Web Widths: 1-5/8," 2-1/2," 3-1/2," 3-5/8," 4," 5-1/2," and 6"
- Legs: 1," 1-1/4," 1-1/2," 2," 2-1/2," and 3"
 *Not all combinations of web, leg, and gauge are available.
- **Material Thicknesses:**
 ProTRAK 25 / 15mil (25ga EQ) 50ksi
 ProTRAK 20 / 18mil (20ga EQ) 50ksi
 ProTRAK 30MIL 33ksi
 ProTRAK 33MIL 33ksi
- G40EQ is standard, G40 available upon request.
- Other coatings available as special order: G40EQ DiamondPlus®, G60 and G90.
- G40EQ DiamondPlus® is only available in select markets and thicknesses. Contact your local sales representative for market availability.

Complies with IBC 2024 • AISI S100 • AISI S220

ProSTUD® 25 (15mil) Drywall Stud

ClarkDietrich ProSTUD 25 (15mil) physical and structural properties

Member	Design thickness (in)	Fy (ksi)	Gross Section Properties						Effective Section Properties at Fy						Torsional Properties					Lu (in)
			Area (in ²)	Weight (lb/ft)	Ix (in ⁴)	Rx (in)	Iy (in ⁴)	Ry (in)	Ae (in ²)	Ix (in ⁴)	Sx (in ³)	Ma (in-lbs)	Vag (lb)	Vanet (lb)	Jx1000 (in ⁴)	Cw (in ⁶)	Xo (in)	Ro (in)	β Beta	
162PDS125-15	0.0158	50	0.071	0.24	0.033	0.688	0.015	0.466	0.033	0.030	0.024	719	232	104	0.00589	0.009	-1.088	1.369	0.368	24.8
250PDS125-15	0.0158	50	0.085	0.29	0.088	1.020	0.018	0.459	0.033	0.080	0.044	1198	147	141	0.00704	0.023	-0.959	1.473	0.576	24.5
362PDS125-15 ¹	0.0158	50	0.102	0.35	0.206	1.420	0.020	0.442	0.034	0.190	0.056	1689	100	100	0.00852	0.051	-0.837	1.706	0.760	24.3
400PDS125-15 ¹	0.0158	50	0.108	0.37	0.260	1.549	0.021	0.436	0.034	0.233	0.062	1870	90	90	0.00901	0.064	-0.803	1.798	0.800	24.2
600PDS125-15 ²	0.0158	50	0.140	0.48	0.683	2.209	0.023	0.404	0.034	0.537	0.105	2781	60	60	0.01164	0.161	-0.666	2.343	0.919	23.6

ProTRAK® 25 (15mil) Drywall Track

ClarkDietrich ProTRAK 25 (15mil) physical and structural properties

Member	Design thickness (in)	Fy (ksi)	Gross Section Properties						Effective Section Properties at Fy						Torsional Properties				
			Area (in ²)	Weight (lb/ft)	Ix (in ⁴)	Rx (in)	Iy (in ⁴)	Ry (in)	Ae (in ²)	Ix (in ⁴)	Sx (in ³)	Ma (in-lbs)	Vag (lb)	Jx1000 (in ⁴)	Cw (in ⁶)	Xo (in)	Ro (in)	β Beta	
162PDT125-15	0.0158	50	0.065	0.22	0.034	0.717	0.011	0.412	0.020	0.021	0.016	464	222	0.00542	0.006	-0.881	1.208	0.468	
250PDT125-15	0.0158	50	0.079	0.27	0.085	1.038	0.013	0.400	0.020	0.059	0.024	724	143	0.00657	0.015	-0.771	1.353	0.675	
362PDT125-15 ¹	0.0158	50	0.097	0.33	0.196	1.425	0.014	0.381	0.021	0.125	0.035	1059	98	0.00805	0.034	-0.668	1.619	0.830	
400PDT125-15 ¹	0.0158	50	0.103	0.35	0.247	1.550	0.014	0.374	0.021	0.153	0.039	1171	89	0.00854	0.043	-0.640	1.718	0.861	
600PDT125-15 ²	0.0158	50	0.134	0.46	0.646	2.194	0.016	0.343	0.021	0.350	0.059	1762	59	0.01117	0.108	-0.524	2.282	0.947	
162PDT200-15	0.0158	50	0.089	0.30	0.050	0.752	0.039	0.663	0.020	0.025	0.015	455	222	0.00739	0.020	-1.579	1.870	0.287	
250PDT200-15	0.0158	50	0.103	0.35	0.124	1.098	0.045	0.662	0.021	0.064	0.024	720	143	0.00854	0.052	-1.431	1.921	0.445	
362PDT200-15 ¹	0.0158	50	0.120	0.41	0.277	1.516	0.051	0.648	0.021	0.137	0.036	1063	98	0.01002	0.120	-1.282	2.088	0.623	
400PDT200-15 ¹	0.0158	50	0.126	0.43	0.344	1.650	0.052	0.642	0.021	0.168	0.039	1178	89	0.01052	0.151	-1.240	2.162	0.671	
600PDT200-15 ²	0.0158	50	0.158	0.54	0.864	2.338	0.058	0.608	0.021	0.389	0.060	1789	59	0.01315	0.383	-1.058	2.638	0.839	
162PDT250-15	0.0158	50	0.105	0.36	0.061	0.766	0.071	0.824	0.020	0.027	0.015	455	222	0.00871	0.038	-2.058	2.345	0.230	
250PDT250-15	0.0158	50	0.118	0.40	0.150	1.123	0.082	0.831	0.021	0.066	0.024	725	143	0.00986	0.096	-1.892	2.352	0.353	
362PDT250-15 ¹	0.0158	50	0.136	0.46	0.330	1.557	0.092	0.823	0.021	0.142	0.036	1073	98	0.01134	0.220	-1.720	2.462	0.512	
400PDT250-15 ¹	0.0158	50	0.142	0.48	0.409	1.696	0.095	0.819	0.021	0.174	0.040	1189	89	0.01183	0.275	-1.670	2.517	0.560	
600PDT250-15 ²	0.0158	50	0.174	0.59	1.009	2.409	0.108	0.787	0.021	0.404	0.060	1809	59	0.01446	0.697	-1.452	2.921	0.753	

Notes:

- Calculated properties are based on AISI S100-16 (2020) w/S2-20 North American Specification for Design of Cold-Formed Steel Structural Members and AISI S220-20 North American Standard for Cold-Formed Steel Framing—Nonstructural Members.
 - Effective properties incorporate the strength increase from the cold work of forming as applicable per Section A3.3.2 of AISI S100-16 (2020) w/S2-20.
 - Tabulated gross properties, including torsional properties, are based on full-unreduced cross section of the studs, away from punchouts.
 - Tabulated gross properties, including torsional properties, are based on full-unreduced cross section of the tracks.
 - For deflection calculations, use the effective moment of inertia.
 - Allowable moment includes cold work of forming.
 - Allowable moment is taken as the lowest value based on local or distortional buckling. Distortional buckling strength is based on a $k\text{-}\phi = 0$.
 - Web depth for track sections is equal to the nominal height plus two times the design thickness plus the bend radius. Hems on nonstructural track sections are ignored.
- 1 Web-height to thickness ratio exceeds 200.
 - 2 Web-height to thickness ratio exceeds 260.

ProSTUD® 20 (18mil) Drywall Stud			ClarkDietrich ProSTUD 20 (18mil) physical and structural properties																		
Member	Design thickness (in)	Fy (ksi)	Gross Section Properties						Effective Section Properties at Fy						Torsional Properties						Lu (in)
			Area (in ²)	Weight (lb/ft)	Ix (in ⁴)	Rx (in)	Iy (in ⁴)	Ry (in)	Ae (in ²)	Ix (in ⁴)	Sx (in ³)	Ma (in-lbs)	Vag (lb)	Vanet (lb)	Jx1000 (in ⁴)	Cw (in ⁶)	Xo (in)	Ro (in)	β Beta		
162PDS125-18	0.0190	70	0.086	0.29	0.040	0.685	0.019	0.468	0.039	0.035	0.028	1194	405	149	0.01032	0.012	-1.105	1.382	0.361	24.8	
250PDS125-18	0.0190	70	0.104	0.35	0.107	1.017	0.023	0.470	0.043	0.099	0.056	2361	256	204	0.01250	0.031	-1.004	1.504	0.555	24.5	
362PDS125-18	0.0190	70	0.126	0.43	0.254	1.421	0.026	0.456	0.044	0.234	0.074	3102	174	170	0.01512	0.070	-0.884	1.734	0.740	24.3	
400PDS125-18 ¹	0.0190	70	0.133	0.45	0.321	1.551	0.027	0.453	0.046	0.286	0.084	3532	157	157	0.01605	0.089	-0.859	1.830	0.780	24.2	
600PDS125-18 ²	0.0190	70	0.173	0.59	0.855	2.223	0.032	0.431	0.046	0.669	0.141	5891	104	104	0.02083	0.233	-0.739	2.382	0.904	23.6	

ProTRAK® 20 (18mil) Drywall Track			ClarkDietrich ProTRAK 20 (18mil) physical and structural properties																	
Member	Design thickness (in)	Fy (ksi)	Gross Section Properties						Effective Section Properties at Fy						Torsional Properties					
			Area (in ²)	Weight (lb/ft)	Ix (in ⁴)	Rx (in)	Iy (in ⁴)	Ry (in)	Ae (in ²)	Ix (in ⁴)	Sx (in ³)	Ma (in-lbs)	Vag (lb)	Jx1000 (in ⁴)	Cw (in ⁶)	Xo (in)	Ro (in)	β Beta		
162PDT125-18	0.0190	50	0.078	0.27	0.040	0.718	0.013	0.411	0.028	0.027	0.022	663	380	0.00943	0.007	-0.879	1.207	0.470		
250PDT125-18	0.0190	50	0.095	0.32	0.102	1.038	0.015	0.400	0.029	0.073	0.034	1029	248	0.01143	0.017	-0.770	1.353	0.676		
362PDT125-18	0.0190	50	0.116	0.40	0.236	1.426	0.017	0.380	0.029	0.173	0.050	1497	170	0.01400	0.041	-0.666	1.619	0.831		
400PDT125-18	0.0190	50	0.123	0.42	0.297	1.550	0.017	0.374	0.029	0.211	0.055	1653	154	0.01486	0.051	-0.638	1.718	0.862		
600PDT125-18 ²	0.0190	50	0.161	0.55	0.778	2.195	0.019	0.342	0.029	0.469	0.083	2473	102	0.01943	0.130	-0.523	2.282	0.947		
162PDT200-18	0.0190	50	0.107	0.36	0.061	0.753	0.047	0.662	0.028	0.032	0.021	642	380	0.01285	0.024	-1.577	1.869	0.288		
250PDT200-18	0.0190	50	0.123	0.42	0.149	1.099	0.054	0.661	0.029	0.088	0.034	1016	248	0.01486	0.063	-1.429	1.920	0.446		
362PDT200-18	0.0190	50	0.145	0.49	0.333	1.517	0.061	0.648	0.029	0.188	0.050	1500	170	0.01743	0.145	-1.280	2.088	0.624		
400PDT200-18	0.0190	50	0.152	0.52	0.414	1.651	0.063	0.642	0.029	0.230	0.055	1661	154	0.01828	0.181	-1.238	2.161	0.672		
600PDT200-18 ²	0.0190	50	0.190	0.65	1.039	2.339	0.070	0.607	0.030	0.532	0.084	2525	102	0.02286	0.461	-1.057	2.637	0.840		
162PDT250-18	0.0190	50	0.126	0.43	0.074	0.767	0.085	0.823	0.028	0.035	0.021	635	380	0.01514	0.045	-2.056	2.344	0.231		
250PDT250-18	0.0190	50	0.142	0.48	0.180	1.125	0.098	0.830	0.029	0.091	0.034	1011	248	0.01714	0.115	-1.891	2.351	0.353		
362PDT250-18	0.0190	50	0.164	0.56	0.398	1.558	0.111	0.823	0.029	0.195	0.050	1498	170	0.01971	0.264	-1.718	2.461	0.512		
400PDT250-18	0.0190	50	0.171	0.58	0.492	1.697	0.114	0.818	0.029	0.239	0.055	1661	154	0.02057	0.331	-1.669	2.517	0.560		
600PDT250-18 ²	0.0190	50	0.209	0.71	1.214	2.410	0.129	0.786	0.030	0.555	0.085	2533	102	0.02514	0.838	-1.450	2.920	0.753		

Notes:

- Calculated properties are based on AISI S100-16 (2020) w/S2-20 North American Specification for Design of Cold-Formed Steel Structural Members and AISI S220-20 North American Standard for Cold-Formed Steel Framing—Nonstructural Members.
 - Effective properties incorporate the strength increase from the cold work of forming as applicable per Section A3.3.2 of AISI S100-16 (2020) w/S2-20.
 - Tabulated gross properties, including torsional properties, are based on full-unreduced cross section of the studs, away from punchouts.
 - Tabulated gross properties, including torsional properties, are based on full-unreduced cross section of the tracks.
 - For deflection calculations, use the effective moment of inertia.
 - Allowable moment includes cold work of forming.
 - Allowable moment is taken as the lowest value based on local or distortional buckling. Distortional buckling strength is based on a k-phi = 0.
 - Web depth for track sections is equal to the nominal height plus two times the design thickness plus the bend radius. Hems on nonstructural track sections are ignored.
- 1 Web-height to thickness ratio exceeds 200.
 - 2 Web-height to thickness ratio exceeds 260.

ProSTUD® 30mil Drywall Stud
(AVAILABLE IN SELECT MARKETS)

ClarkDietrich ProSTUD 30MIL physical and structural properties

Member	Design thickness (in)	Fy (ksi)	Gross Section Properties						Effective Section Properties at Fy						Torsional Properties					Lu (in)
			Area (in ²)	Weight (lb/ft)	Ix (in ⁴)	Rx (in)	Iy (in ⁴)	Ry (in)	Ae (in ²)	Ix (in ⁴)	Sx (in ³)	Ma (in-lbs)	Vag (lb)	Vanet (lb)	J* 1000 (in ⁴)	Cw (in ⁶)	Xo (in)	Ro (in)	β Beta	
162PDS125-30	0.0312	33	0.137	0.47	0.064	0.681	0.029	0.458	0.098	0.064	0.067	1332	572	124	0.04459	0.017	-1.070	1.348	0.371	30.8
250PDS125-30	0.0312	33	0.165	0.56	0.169	1.012	0.034	0.451	0.106	0.168	0.121	2356	832	397	0.05345	0.042	-0.941	1.454	0.581	30.1
362PDS125-30	0.0312	33	0.200	0.68	0.398	1.411	0.038	0.434	0.107	0.396	0.170	3358	776	457	0.06484	0.096	-0.820	1.689	0.764	29.7
400PDS125-30	0.0312	33	0.212	0.72	0.501	1.540	0.039	0.428	0.108	0.499	0.189	3737	701	490	0.06864	0.120	-0.787	1.781	0.805	29.5
600PDS125-30	0.0312	33	0.274	0.93	1.324	2.199	0.043	0.396	0.109	1.281	0.338	6031	461	461	0.08888	0.303	-0.651	2.327	0.922	28.7

ProTRAK® 30mil Drywall Track

ClarkDietrich ProTRAK 30MIL physical and structural properties

Member	Design thickness (in)	Fy (ksi)	Gross Section Properties						Effective Section Properties at Fy						Torsional Properties					
			Area (in ²)	Weight (lb/ft)	Ix (in ⁴)	Rx (in)	Iy (in ⁴)	Ry (in)	Ae (in ²)	Ix (in ⁴)	Sx (in ³)	Ma (in-lbs)	Vag (lb)	J* 1000 (in ⁴)	Cw (in ⁶)	Xo (in)	Ro (in)	β Beta		
162PDT125-30	0.0312	33	0.128	0.44	0.067	0.722	0.022	0.409	0.080	0.054	0.048	951	610	0.04168	0.011	-0.872	1.204	0.475		
250PDT125-30	0.0312	33	0.156	0.53	0.169	1.042	0.025	0.397	0.084	0.140	0.087	1713	832	0.05054	0.029	-0.763	1.351	0.681		
362PDT125-30	0.0312	33	0.191	0.65	0.389	1.428	0.027	0.378	0.087	0.330	0.149	2938	755	0.06193	0.067	-0.661	1.619	0.833		
400PDT125-30	0.0312	33	0.203	0.69	0.489	1.553	0.028	0.371	0.088	0.417	0.172	3407	683	0.06573	0.084	-0.633	1.718	0.864		
600PDT125-30	0.0312	33	0.265	0.90	1.278	2.196	0.031	0.340	0.090	1.074	0.240	4737	454	0.08597	0.212	-0.519	2.282	0.948		
162PDT200-30	0.0312	33	0.175	0.60	0.101	0.758	0.076	0.660	0.081	0.067	0.052	1028	610	0.05687	0.040	-1.570	1.864	0.291		
250PDT200-30	0.0312	33	0.203	0.69	0.246	1.103	0.088	0.659	0.086	0.170	0.094	1862	832	0.06573	0.103	-1.423	1.917	0.449		
362PDT200-30	0.0312	33	0.238	0.81	0.549	1.520	0.099	0.645	0.089	0.397	0.160	3159	755	0.07712	0.237	-1.274	2.086	0.627		
400PDT200-30	0.0312	33	0.249	0.85	0.682	1.654	0.102	0.639	0.089	0.502	0.176	3480	683	0.08091	0.297	-1.232	2.160	0.674		
600PDT200-30	0.0312	33	0.312	1.06	1.710	2.342	0.114	0.605	0.091	1.353	0.262	5170	454	0.10116	0.754	-1.051	2.637	0.841		
162PDT250-30	0.0312	33	0.206	0.70	0.123	0.772	0.139	0.821	0.082	0.073	0.054	1059	610	0.06699	0.075	-2.048	2.338	0.233		
250PDT250-30	0.0312	33	0.234	0.80	0.298	1.129	0.160	0.828	0.086	0.186	0.097	1926	832	0.07585	0.190	-1.883	2.347	0.356		
362PDT250-30	0.0312	33	0.269	0.92	0.656	1.562	0.181	0.820	0.089	0.436	0.157	3097	755	0.08724	0.435	-1.712	2.458	0.515		
400PDT250-30	0.0312	33	0.281	0.96	0.812	1.701	0.187	0.816	0.090	0.551	0.173	3425	683	0.09104	0.543	-1.662	2.514	0.563		
600PDT250-30	0.0312	33	0.343	1.17	1.997	2.413	0.211	0.784	0.092	1.473	0.261	5162	454	0.11128	1.373	-1.444	2.919	0.755		

Notes:

- Calculated properties are based on AISI S100-16 (2020) w/S2-20 North American Specification for Design of Cold-Formed Steel Structural Members and AISI S220-20 North American Standard for Cold-Formed Steel Framing—Nonstructural Members.
 - Effective properties incorporate the strength increase from the cold work of forming as applicable per Section A3.3.2 of AISI S100-16 (2020) w/S2-20.
 - Tabulated gross properties, including torsional properties, are based on full-unreduced cross section of the studs, away from punchouts.
 - Tabulated gross properties, including torsional properties, are based on full-unreduced cross section of the tracks.
 - For deflection calculations, use the effective moment of inertia.
 - Allowable moment includes cold work of forming.
 - Allowable moment is taken as the lowest value based on local or distortional buckling. Distortional buckling strength is based on a k-phi = 0.
 - Web depth for track sections is equal to the nominal height plus two times the design thickness plus the bend radius. Hems on nonstructural track sections are ignored.
- 1 Web-height to thickness ratio exceeds 200.
 - 2 Web-height to thickness ratio exceeds 260.

ProSTUD® 33mil Drywall Stud
(AVAILABLE IN SELECT MARKETS)

ClarkDietrich ProSTUD 33MIL physical and structural properties

Member	Design thickness (in)	Fy (ksi)	Gross Section Properties						Effective Section Properties at Fy						Torsional Properties					Lu (in)
			Area (in ²)	Weight (lb/ft)	Ix (in ⁴)	Rx (in)	Iy (in ⁴)	Ry (in)	Ae (in ²)	Ix (in ⁴)	Sx (in ³)	Ma (in-lbs)	Vag (lb)	Vanet (lb)	J* 1000 (in ⁴)	Cw (in ⁶)	Xo (in)	Ro (in)	β Beta	
162PDS125-33	0.0346	33	0.152	0.52	0.070	0.679	0.032	0.456	0.114	0.070	0.078	1541	632	123	0.06059	0.019	-1.065	1.344	0.371	30.8
250PDS125-33	0.0346	33	0.182	0.62	0.186	1.010	0.037	0.449	0.125	0.186	0.138	2697	1007	431	0.07267	0.046	-0.937	1.449	0.582	30.1
362PDS125-33	0.0346	33	0.221	0.75	0.439	1.409	0.041	0.433	0.127	0.439	0.200	3943	1024	541	0.08820	0.106	-0.816	1.685	0.766	29.6
400PDS125-33	0.0346	33	0.234	0.80	0.553	1.538	0.043	0.426	0.128	0.553	0.222	4394	957	602	0.09338	0.132	-0.783	1.777	0.806	29.5
600PDS125-33	0.0346	33	0.303	1.03	1.463	2.196	0.047	0.394	0.130	1.428	0.399	7021	630	630	0.12100	0.332	-0.647	2.323	0.922	28.6

ProTRAK® 33mil Drywall Track

ClarkDietrich ProTRAK 33MIL physical and structural properties

Member	Design thickness (in)	Fy (ksi)	Gross Section Properties						Effective Section Properties at Fy						Torsional Properties					
			Area (in ²)	Weight (lb/ft)	Ix (in ⁴)	Rx (in)	Iy (in ⁴)	Ry (in)	Ae (in ²)	Ix (in ⁴)	Sx (in ³)	Ma (in-lbs)	Vag (lb)	J* 1000 (in ⁴)	Cw (in ⁶)	Xo (in)	Ro (in)	β Beta		
162PDT125-33	0.0346	33	0.142	0.48	0.075	0.723	0.024	0.409	0.095	0.063	0.056	1104	677	0.05683	0.012	-0.870	1.203	0.477		
250PDT125-33	0.0346	33	0.173	0.59	0.188	1.043	0.027	0.397	0.102	0.160	0.100	1972	1024	0.06891	0.032	-0.762	1.351	0.682		
362PDT125-33	0.0346	33	0.212	0.72	0.432	1.429	0.030	0.377	0.105	0.375	0.170	3358	1024	0.08444	0.074	-0.659	1.618	0.834		
400PDT125-33	0.0346	33	0.225	0.77	0.542	1.554	0.031	0.371	0.106	0.473	0.197	3887	931	0.08962	0.093	-0.632	1.718	0.865		
600PDT125-33	0.0346	33	0.294	1.00	1.418	2.197	0.034	0.339	0.109	1.237	0.287	5681	619	0.11723	0.234	-0.517	2.282	0.949		
162PDT200-33	0.0346	33	0.194	0.66	0.112	0.759	0.085	0.660	0.097	0.077	0.061	1198	677	0.07754	0.045	-1.568	1.862	0.292		
250PDT200-33	0.0346	33	0.225	0.77	0.274	1.104	0.097	0.658	0.104	0.196	0.109	2150	1024	0.08962	0.114	-1.421	1.916	0.450		
362PDT200-33	0.0346	33	0.264	0.90	0.610	1.521	0.110	0.645	0.107	0.452	0.186	3669	1024	0.10515	0.263	-1.272	2.085	0.628		
400PDT200-33	0.0346	33	0.276	0.94	0.758	1.655	0.113	0.639	0.108	0.567	0.215	4246	931	0.11033	0.329	-1.230	2.159	0.675		
600PDT200-33	0.0346	33	0.346	1.18	1.897	2.342	0.126	0.604	0.111	1.520	0.322	6355	619	0.13795	0.835	-1.050	2.637	0.842		
162PDT250-33	0.0346	33	0.229	0.78	0.137	0.774	0.154	0.821	0.098	0.085	0.063	1235	677	0.09135	0.083	-2.046	2.336	0.233		
250PDT250-33	0.0346	33	0.259	0.88	0.331	1.130	0.177	0.827	0.104	0.214	0.113	2225	1024	0.10343	0.211	-1.881	2.346	0.357		
362PDT250-33	0.0346	33	0.298	1.01	0.728	1.563	0.200	0.820	0.108	0.493	0.193	3808	1024	0.11896	0.482	-1.710	2.457	0.516		
400PDT250-33	0.0346	33	0.311	1.06	0.901	1.702	0.207	0.815	0.109	0.622	0.214	4221	931	0.12414	0.602	-1.660	2.514	0.564		
600PDT250-33	0.0346	33	0.380	1.29	2.216	2.414	0.233	0.783	0.111	1.657	0.320	6327	619	0.15175	1.522	-1.443	2.919	0.756		

Notes:

- Calculated properties are based on AISI S100-16 (2020) w/S2-20 North American Specification for Design of Cold-Formed Steel Structural Members and AISI S220-20 North American Standard for Cold-Formed Steel Framing—Nonstructural Members.
 - Effective properties incorporate the strength increase from the cold work of forming as applicable per Section A3.3.2 of AISI S100-16 (2020) w/S2-20.
 - Tabulated gross properties, including torsional properties, are based on full-unreduced cross section of the studs, away from punchouts.
 - Tabulated gross properties, including torsional properties, are based on full-unreduced cross section of the tracks.
 - For deflection calculations, use the effective moment of inertia.
 - Allowable moment includes cold work of forming.
 - Allowable moment is taken as the lowest value based on local or distortional buckling. Distortional buckling strength is based on a k-phi = 0.
 - Web depth for track sections is equal to the nominal height plus two times the design thickness plus the bend radius. Hems on nonstructural track sections are ignored.
- 1** Web-height to thickness ratio exceeds 200.
2 Web-height to thickness ratio exceeds 260.

Which ProSTUD® Limiting Heights Table Should I Use?

ProSTUD, like any interior drywall stud, may be used in a variety of applications including walls, ceilings, and soffits. While some conditions may require the expertise of a design professional, many assemblies can be selected based on tabulated data. Using the diagrams below, locate the required assembly and follow the instructions for selecting the proper ProSTUD member.

Head-of-Wall (HOW) Composite Using Deflection Track

HOW Composite Wall w/ 30mil 2-1/2" Leg MaxTrak® or 30mil 2-1/2" Deep Leg Deflection Track

HOW Composite limiting heights were tested in accordance with AISI S916 and ICC-ES AC86.

The tests were modified from the standards with the tracks fastened to the test fixture such that the wall stiffness included the track deformation.

It is important to note that a wall designed using limiting heights from HOW composite tables must be constructed consistent with notes listed below the HOW Composite limiting heights tables.

Use Head-of-Wall Composite tables if your wall meets these conditions:

- Maximum deflection gap is 7/8" or less
 - Meets the requirements of the most common 1/2" and 3/4" deflection gap
- For use with the following Deflection Tracks:
 - 30mil 2-1/2" Leg MaxTrak
 - 30mil 2-1/2" Deep Leg Deflection Track
 - Thicker MaxTrak or Deep Leg Deflection Track noted above are allowed but won't increase limiting heights without additional testing
- 5/8" Type X Gypsum board applied full height in the vertical orientation
 - (Leaving a 7/8" max. deflection gap and not having the board attached to the top deflection track is allowed.)

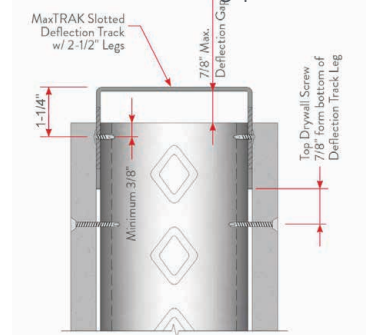

HOW Composite w/MaxTRAK

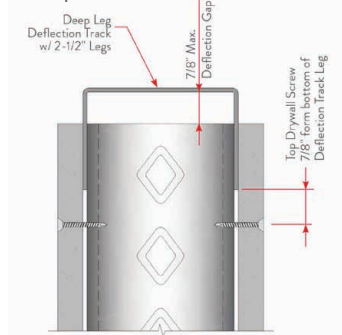

HOW Composite w/Deep Leg Deflection Track

Full Composite Assemblies

Full Composite wall w/ 1-1/4" Leg Non-Deflection Track

Full Composite limiting height data can be applied to walls where gypsum board is installed vertically on both flanges of the stud, for the full height of the wall and attached to the top and bottom tracks. ProSTUD composite data is based on the 2024 International Building Code, and was tested and analyzed in accordance with AISI S916 and ICC-ES AC86. Composite limiting height tables for ProSTUD members are available starting on page 20 of this catalog.

It is important to note that a wall designed using limiting heights from composite tables must be constructed consistent with the assembly as it was tested per AISI S916 and ICC-ES AC86.

Not to be used with:

- Deflection Tracks
- Resilient Channel
- Sound Clips
- 1/2" Gypsum Board
- Horizontally Installed Board

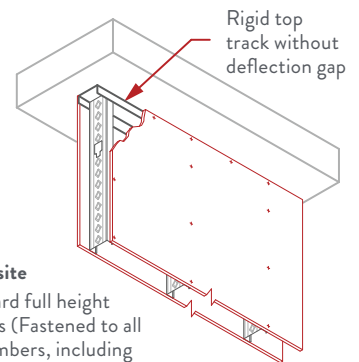

Full Composite

Gypsum board full height on both sides (Fastened to all framing members, including top and bottom tracks)

Non-Composite Assemblies

Non-composite conditions are common in all structures. When the gypsum board stops at the ceiling level, but the stud continues to the deck, it is a non-composite condition. **Wall framing with Deflection Track, Resilient Channel (RC) or Sound Clips is a non-composite design since the screws attaching the gypsum board are not directly attached to the framing or top track.** While there may be advantages to contacting Technical Services or a Design Professional, many conditions can be covered by limiting heights tables shown in this catalog or at clarkdietrich.com. When in doubt, call our complimentary Technical Services Hotline at 888-437-3244.

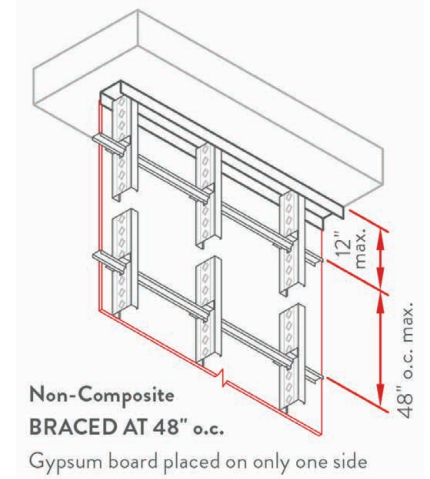
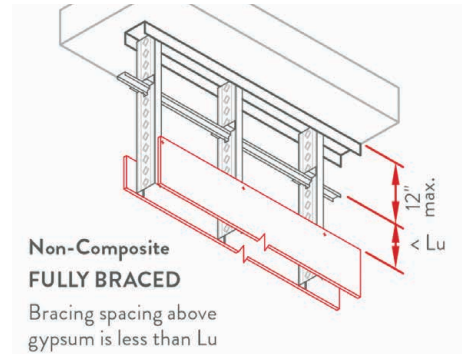
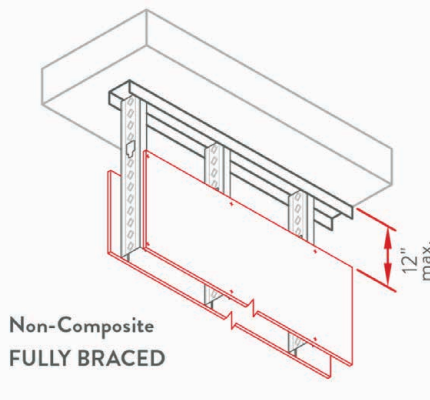

Distance of unbraced length (Lu) can be found in the physical and structural properties starting on page 6.

Other Assemblies

Chase Walls or Furred Walls

Chase and furred walls are common, but the conditions vary greatly depending on the building requirements. While non-composite tables may be used conservatively, when in doubt, contact our Technical Services Hotline at 888-437-3244 for chase wall designs.

Ceilings

Interior ceilings are often supported by ProSTUD framing. The design criteria varies greatly based on the weight of the ceiling, bracing, and support points. You'll find a partial listing of ceiling span tables on page 28. Visit clarkdietrich.com/ProSTUD for more comprehensive data.

ClarkDietrich SubmittalPro® and iTools

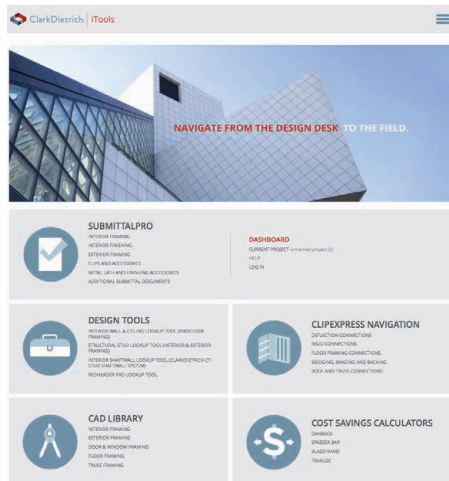

SubmittalPro® and Lookup Tools
itools.clarkdietrich.com – Mobile Friendly

SubmittalPro®
We built this online technical submittal generator tool to make your job easier. Use it to quickly view data on our products and create your final submittal documents.

Interior Wall & Ceiling Lookup Tools
Perform a fast, easy search by: design, limiting height, fire rating or STC sound rating.

Direct links to: UL Design Reports, STC sound tests and ProSTUD submittals.

ProSTUD® 25 / 15mil Head-of-Wall (HOW) Composite Limiting Heights
w/ 30mil 2-1/2" Leg MaxTRAK®

5/8" Type X Gypsum Board

Width	Stud Member	Yield Strength	Spacing (in) o.c.	5psf			7.5psf			10psf		
				L/120	L/240	L/360	L/120	L/240	L/360	L/120	L/240	L/360
3-5/8"	ProSTUD 25 / 15 mil 362PDS125-15	50 ksi	12	19'-9"	16'-6"	14'-6"	16'-10" f	14'-5"	12'-8"	14'-7" f	13'-1"	11'-3"
			16	18'-7"	15'-6"	13'-7"	15'-4" f	13'-7"	11'-10"	13'-3" f	12'-4"	10'-3"
			24	15'-10" f	13'-7"	11'-10"	12'-11" f	11'-10"	10'-1"	11'-2" f	10'-7"	8'-10"
4"	ProSTUD 25 / 15 mil 400PDS125-15	50 ksi	12	20'-11"	17'-6"	15'-3"	18'-3"	15'-3"	13'-4"	16'-2" f	13'-11"	12'-1"
			16	19'-9"	16'-4"	14'-4"	16'-6" f	14'-4"	12'-6"	14'-4" f	13'-0"	11'-2"
			24	16'-6" f	14'-4"	12'-6"	13'-6" f	12'-6"	10'-8"	11'-8" f	11'-3"	9'-6"
6"	ProSTUD 25 / 15 mil 600PDS125-15	50 ksi	12	27'-10" f	23'-8"	20'-8"	22'-9" f	20'-8"	18'-1"	19'-8" f	18'-9"	16'-5"
			16	24'-1" f	21'-11"	19'-5"	19'-8" f	19'-2"	17'-0"	17'-1" f	17'-1" f	15'-2"
			24	19'-8" f	19'-2"	17'-0"	16'-1" f	16'-1" f	14'-9"	13'-11" f	13'-11" f	13'-2"

Notes:

- Allowable HOW composite limiting heights were tested in accordance with AISI S916 and ICC-ES AC86.
- The tests were modified from the standards with the tracks fastened to the test fixture such that the wall stiffness included the track deformation.
- In accordance with current building codes and AISI design standards, the 1/3 Stress Increase for strength was not used.
- The composite limiting heights provided in the tables are based on a single layer of 5/8" Type X Gypsum Board from the following manufacturers: American, CertainTeed, Georgia Pacific, Continental, National, PABCO, and USG.
- The gypsum board must be applied full height in the vertical orientation to each stud flange and installed in accordance with ASTM C754 using minimum No. 6 Type S Drywall screws spaced as listed below:
 - Sheathing screws spaced a maximum of 16 in on-center to framing members (including bottom track) when studs spaced at 16 in or 12 in on-center.
 - Sheathing screws spaced a maximum of 12 in on-center to framing members (including bottom track) when studs spaced at 24 in on-center.
- #8 wafer head screws shall be used for attaching the stud to 30mil 2-1/2" Leg MaxTRAK (as top track) adhering to details below:
 - Stud to track connection must be installed as depicted in figure with a maximum gap of 7/8" between the web of the MaxTRAK and end of stud.
 - Slots in the MaxTRAK Legs allows for a total vertical movement of 1-1/2" (± 3/4") with screw centered in slots
 - Screws shall be placed in each flange of the stud at a minimum of 3/8" from the end of the stud
 - To permit head of wall deflection, gypsum board must not be fastened directly to the MaxTRAK
- No fasteners are required for attaching the stud to the bottom track except as detailed in ASTM C754.
- f** Adjacent to the height value indicates that flexural stress controls the allowable wall height.

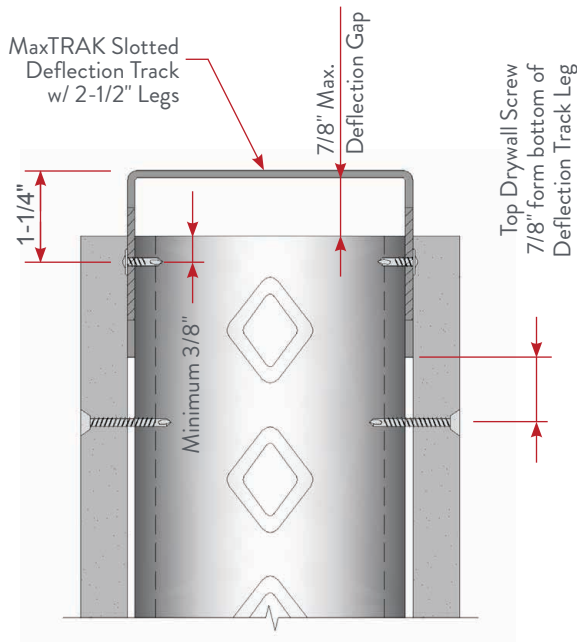

ProSTUD® 20 / 18mil Head-of-Wall (HOW) Composite Limiting Heights w/ 30mil 2-1/2" Leg MaxTRAK®				5/8" Type X Gypsum Board								
Width	Stud Member	Yield Strength	Spacing (in) o.c.	5psf			7.5psf			10psf		
				L/120	L/240	L/360	L/120	L/240	L/360	L/120	L/240	L/360
2-1/2"	ProSTUD 20 / 18 mil 250PDS125-18	70 ksi	12	17'-5"	14'-8"	12'-10"	15'-3"	12'-10"	11'-2"	13'-10"	11'-8"	10'-2"
			16	16'-8"	14'-0"	12'-3"	14'-6"	12'-3"	10'-8"	13'-2"	11'-2" f	9'-6"
			24	15'-2"	12'-10"	11'-1"	13'-2" f	11'-2"	9'-6"	11'-5" f	10'-2"	8'-2"
3-5/8"	ProSTUD 20 / 18 mil 362PDS125-18	70 ksi	12	21'-2"	17'-8"	15'-5"	18'-6"	15'-6"	13'-5"	16'-10"	14'-1"	12'-3"
			16	19'-11"	16'-8"	14'-6"	17'-5"	14'-7"	12'-8"	15'-10"	13'-3"	11'-3"
			24	18'-0"	15'-0"	13'-0"	15'-9" f	13'-2"	11'-2"	13'-7" f	11'-11"	9'-9"
4"	ProSTUD 20 / 18 mil 400PDS125-18	70 ksi	12	22'-5"	18'-8"	16'-4"	19'-7"	16'-4"	14'-3"	17'-10"	14'-10"	13'-0"
			16	21'-0"	17'-7"	15'-4"	18'-4"	15'-4"	13'-5"	16'-8"	13'-11"	12'-2"
			24	18'-11"	15'-10"	13'-10"	16'-6"	13'-10"	12'-1"	14'-4" f	12'-6"	10'-6"
6"	ProSTUD 20 / 18 mil 600PDS125-18	70 ksi	12	30'-1"	25'-1"	21'-11"	26'-4"	21'-11"	19'-1"	23'-11"	19'-11"	17'-4"
			16	28'-1"	23'-4"	20'-5"	24'-6"	20'-5"	17'-10"	21'-6" f	18'-7"	16'-2"
			24	25'-1"	20'-11"	18'-3"	20'-9" f	18'-3"	15'-11"	18'-0" f	16'-7"	13'-8"

Notes:

- Allowable HOW composite limiting heights were tested in accordance with AISI S916 and ICC-ES AC86.
- The tests were modified from the standards with the tracks fastened to the test fixture such that the wall stiffness included the track deformation.
- In accordance with current building codes and AISI design standards, the 1/3 Stress Increase for strength was not used.
- The composite limiting heights provided in the tables are based on a single layer of 5/8" Type X Gypsum Board from the following manufacturers: American, CertainTeed, Georgia Pacific, Continental, National, PABCO, and USG.
- The gypsum board must be applied full height in the vertical orientation to each stud flange and installed in accordance with ASTM C754 using minimum No. 6 Type S Drywall screws spaced as listed below:
 - Sheathing screws spaced a maximum of 16 in on-center to framing members (including bottom track) when studs spaced at 16 in or 12 in on-center.
 - Sheathing screws spaced a maximum of 12 in on-center to framing members (including bottom track) when studs spaced at 24 in on-center.
- #8 wafer head screws shall be used for attaching the stud to 30mil 2-1/2" Leg MaxTRAK (as top track) adhering to details below:
 - Stud to track connection must be installed as depicted in figure with a maximum gap of 7/8" between the web of the MaxTRAK and end of stud.
 - Slots in the MaxTRAK Legs allows for a total vertical movement of 1-1/2" (± 3/4") with screw centered in slots
 - Screws shall be placed in each flange of the stud at a minimum of 3/8" from the end of the stud
 - To permit head of wall deflection, gypsum board must not be fastened directly to the MaxTRAK
- No fasteners are required for attaching the stud to the bottom track except as detailed in ASTM C754.
- f** Adjacent to the height value indicates that flexural stress controls the allowable wall height.

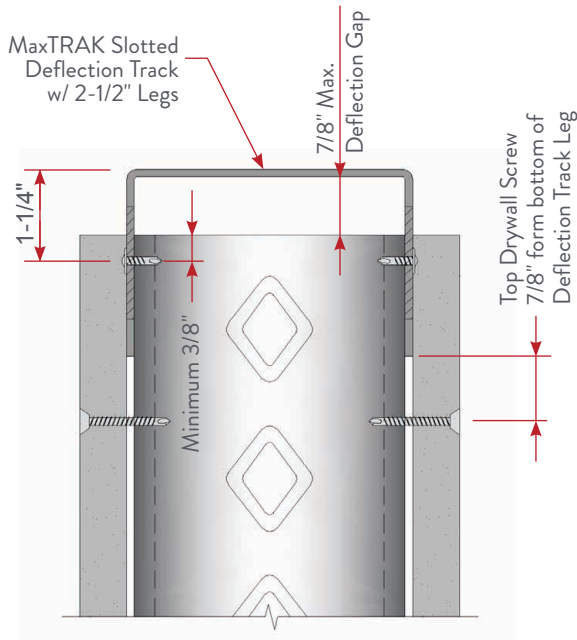

Complies with IBC 2024 • AISI S100 • AISI S220

ProSTUD® 30 mil Head-of-Wall (HOW) Composite Limiting Heights
w/ 30mil 2-1/2" Leg MaxTRAK®

5/8" Type X Gypsum Board

Width	Stud Member	Yield Strength	Spacing (in) o.c.	5psf			7.5psf			10psf		
				L/120	L/240	L/360	L/120	L/240	L/360	L/120	L/240	L/360
2-1/2"	ProSTUD 30 mil 250PDS125-30	33 ksi	12	17'-10"	14'-10"	13'-0"	15'-7"	13'-0"	11'-4"	14'-2"	11'-10"	10'-4"
			16	16'-7"	13'-10"	12'-1"	14'-6"	12'-1"	10'-6"	13'-2"	11'-0"	9'-5"
			24	14'-10"	12'-4"	10'-9"	13'-0"	10'-9"	9'-2"	11'-9"	9'-8"	8'-1"
3-5/8"	ProSTUD 30 mil 362PDS125-30	33 ksi	12	24'-0"	19'-8"	17'-2"	21'-0"	17'-2"	15'-0"	19'-1"	15'-7"	13'-8"
			16	22'-4"	18'-4"	16'-1"	19'-6"	16'-1"	14'-0"	17'-9"	14'-7"	12'-8"
			24	19'-11"	16'-2"	14'-2"	17'-5"	14'-2"	12'-3"	15'-10"	12'-10"	11'-0"
4"	ProSTUD 30 mil 400PDS125-30	33 ksi	12	26'-0"	20'-8"	18'-1"	22'-9"	18'-1"	15'-9"	20'-8"	16'-5"	14'-4"
			16	24'-3"	19'-3"	16'-10"	21'-2"	16'-10"	14'-8"	19'-3"	15'-3"	13'-4"
			24	21'-8"	17'-2"	15'-0"	18'-11"	15'-0"	13'-1"	17'-2"	13'-7"	11'-8"
6"	ProSTUD 30 mil 600PDS125-30	33 ksi	12	34'-2"	28'-2"	24'-9"	29'-10"	24'-7"	21'-8"	27'-1"	22'-4"	19'-8"
			16	31'-9"	26'-2"	23'-0"	27'-9"	22'-10"	20'-1"	25'-2"	20'-9"	18'-3"
			24	28'-4"	23'-1"	20'-2"	24'-9"	20'-2"	17'-7"	22'-0" f	18'-4"	—

Notes:

- Allowable HOW composite limiting heights were tested in accordance with AISI S916 and ICC-ES AC86.
- The tests were modified from the standards with the tracks fastened to the test fixture such that the wall stiffness included the track deformation.
- In accordance with current building codes and AISI design standards, the 1/3 Stress Increase for strength was not used.
- The composite limiting heights provided in the tables are based on a single layer of 5/8" Type X Gypsum Board from the following manufacturers: American, CertainTeed, Georgia Pacific, Continental, National, PABCO, and USG.
- The gypsum board must be applied full height in the vertical orientation to each stud flange and installed in accordance with ASTM C754 using minimum No. 6 Type S Drywall screws spaced as listed below:
 - Sheathing screws spaced a maximum of 16 in on-center to framing members (including bottom track) when studs spaced at 16 in or 12 in on-center.
 - Sheathing screws spaced a maximum of 12 in on-center to framing members (including bottom track) when studs spaced at 24 in on-center.
- #8 wafer head screws shall be used for attaching the stud to 30mil 2-1/2" Leg MaxTRAK (as top track) adhering to details below:
 - Stud to track connection must be installed as depicted in figure with a maximum gap of 7/8" between the web of the MaxTRAK and end of stud.
 - Slots in the MaxTRAK Legs allows for a total vertical movement of 1-1/2" (± 3/4") with screw centered in slots
 - Screws shall be placed in each flange of the stud at a minimum of 3/8" from the end of the stud
 - To permit head of wall deflection, gypsum board must not be fastened directly to the MaxTRAK
- No fasteners are required for attaching the stud to the bottom track except as detailed in ASTM C754.
- f** Adjacent to the height value indicates that flexural stress controls the allowable wall height.

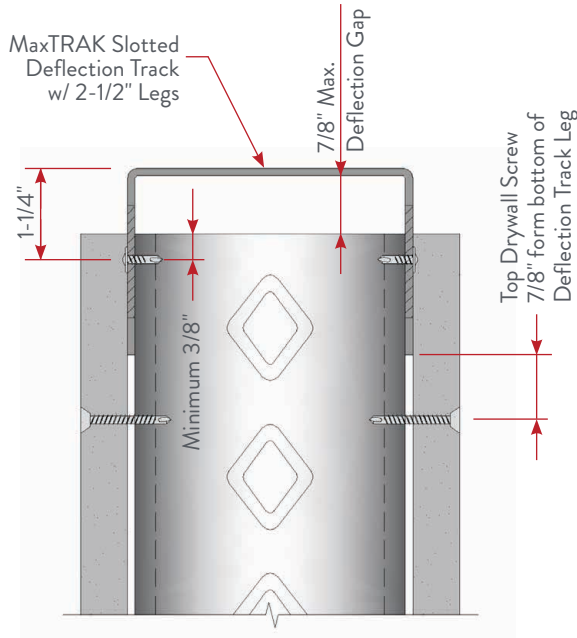

Complies with IBC 2024 • AISI S100 • AISI S220

ProSTUD® 33mil Head-of-Wall (HOW) Composite Limiting Heights w/ 30mil 2-1/2" Leg MaxTRAK®				5/8" Type X Gypsum Board								
Width	Stud Member	Yield Strength	Spacing (in) o.c.	5psf			7.5psf			10psf		
				L/120	L/240	L/360	L/120	L/240	L/360	L/120	L/240	L/360
2-1/2"	ProSTUD 33 mil 250PDS125-33	33 ksi	12	18'-9"	14'-10"	13'-0"	16'-4"	13'-0"	11'-4"	14'-10"	11'-10"	10'-4"
			16	17'-5"	13'-10"	12'-1"	15'-2"	12'-1"	10'-6"	13'-10"	11'-0"	9'-5"
			24	15'-6"	12'-4"	10'-9"	13'-7"	10'-9"	9'-2"	12'-4"	9'-8"	8'-1"
3-5/8"	ProSTUD 33 mil 362PDS125-33	33 ksi	12	24'-10"	19'-8"	17'-2"	21'-8"	17'-2"	15'-0"	19'-8"	15'-7"	13'-8"
			16	23'-2"	18'-4"	16'-1"	20'-3"	16'-1"	14'-0"	18'-4"	14'-7"	12'-8"
			24	20'-9"	16'-5"	14'-4"	18'-1"	14'-4"	12'-5"	16'-5"	13'-1"	11'-1"
4"	ProSTUD 33 mil 400PDS125-33	33 ksi	12	26'-0"	20'-8"	18'-1"	22'-9"	18'-1"	15'-9"	20'-8"	16'-5"	14'-4"
			16	24'-3"	19'-3"	16'-10"	21'-2"	16'-10"	14'-8"	19'-3"	15'-3"	13'-4"
			24	21'-8"	17'-2"	15'-0"	18'-11"	15'-0"	13'-1"	17'-2"	13'-8"	11'-8"
6"	ProSTUD 33 mil 600PDS125-33	33 ksi	12	34'-5"	28'-2"	24'-11"	30'-1"	24'-7"	21'-9"	27'-4"	22'-4"	19'-9"
			16	32'-1"	26'-2"	23'-2"	28'-0"	22'-11"	20'-3"	25'-5"	20'-10"	18'-5"
			24	28'-8"	23'-5"	20'-8"	25'-0"	20'-6"	18'-1"	22'-9"	18'-7"	16'-4"

Notes:

- Allowable HOW composite limiting heights were tested in accordance with AISI S916 and ICC-ES AC86.
- The tests were modified from the standards with the tracks fastened to the test fixture such that the wall stiffness included the track deformation.
- In accordance with current building codes and AISI design standards, the 1/3 Stress Increase for strength was not used.
- The composite limiting heights provided in the tables are based on a single layer of 5/8" Type X Gypsum Board from the following manufacturers: American, CertainTeed, Georgia Pacific, Continental, National, PABCO, and USG.
- The gypsum board must be applied full height in the vertical orientation to each stud flange and installed in accordance with ASTM C754 using minimum No. 6 Type S Drywall screws spaced as listed below:
 - Sheathing screws spaced a maximum of 16 in on-center to framing members (including bottom track) when studs spaced at 16 in or 12 in on-center.
 - Sheathing screws spaced a maximum of 12 in on-center to framing members (including bottom track) when studs spaced at 24 in on-center.
- #8 wafer head screws shall be used for attaching the stud to 30mil 2-1/2" Leg MaxTRAK (as top track) adhering to details below:
 - Stud to track connection must be installed as depicted in figure with a maximum gap of 7/8" between the web of the MaxTRAK and end of stud.
 - Slots in the MaxTRAK Legs allows for a total vertical movement of 1-1/2" ($\pm 3/4"$) with screw centered in slots
 - Screws shall be placed in each flange of the stud at a minimum of 3/8" from the end of the stud
 - To permit head of wall deflection, gypsum board must not be fastened directly to the MaxTRAK
- No fasteners are required for attaching the stud to the bottom track except as detailed in ASTM C754.
- f** Adjacent to the height value indicates that flexural stress controls the allowable wall height.

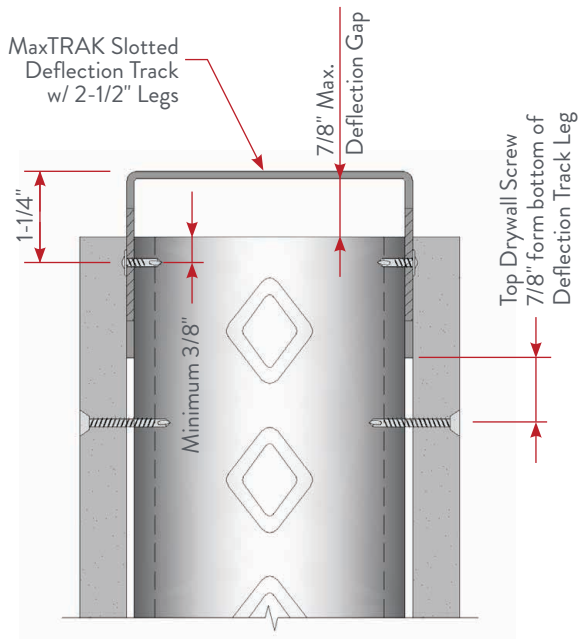

Complies with IBC 2024 • AISI S100 • AISI S220

ProSTUD® 25 / 15mil Head-of-Wall (HOW) Composite Limiting Heights
w/ 30mil 2-1/2" Leg Deflection Track

5/8" Type X Gypsum Board

Width	Stud Member	Yield Strength	Spacing (in) o.c.	5psf			7.5psf			10psf		
				L/120	L/240	L/360	L/120	L/240	L/360	L/120	L/240	L/360
3-5/8"	ProSTUD 25 / 15 mil 362PDS125-15	50 ksi	12	19'-9"	16'-6"	14'-6"	16'-10" f	14'-5"	12'-8"	14'-7" f	13'-1"	11'-3"
			16	18'-7"	15'-6"	13'-7"	15'-4" f	13'-7"	11'-10"	13'-3" f	12'-4"	10'-3"
			24	15'-10" f	13'-7"	11'-10"	12'-11" f	11'-10"	10'-1"	11'-2" f	10'-7"	8'-10"
4"	ProSTUD 25 / 15 mil 400PDS125-15	50 ksi	12	20'-11"	17'-6"	15'-3"	18'-0" f	15'-3"	13'-4"	15'-7" f	13'-11"	12'-1"
			16	19'-9"	16'-4"	14'-4"	16'-4" f	14'-4"	12'-6"	14'-2" f	13'-0"	11'-2"
			24	16'-6" f	14'-4"	12'-6"	13'-6" f	12'-6"	10'-8"	11'-8" f	11'-3"	9'-6"
6"	ProSTUD 25 / 15 mil 600PDS125-15	50 ksi	12	27'-10" f	23'-8"	20'-8"	22'-9" f	20'-8"	18'-1"	19'-8" f	18'-9"	16'-5"
			16	24'-1" f	21'-11"	19'-5"	19'-8" f	19'-2"	17'-0"	17'-1" f	17'-1" f	15'-2"
			24	19'-8" f	19'-2"	17'-0"	16'-1" f	16'-1" f	14'-9"	13'-11" f	13'-11" f	13'-2"

Notes:

- Allowable HOW composite limiting heights were tested in accordance with AISI S916 and ICC-ES AC86.
 - The tests were modified from the standards with the tracks fastened to the test fixture such that the wall stiffness included the track deformation.
 - In accordance with current building codes and AISI design standards, the 1/3 Stress Increase for strength was not used.
 - The composite limiting heights provided in the tables are based on a single layer of 5/8" Type X Gypsum Board from the following manufacturers: American, CertainTeed, Georgia Pacific, Continental, National, PABCO, and USG.
 - The gypsum board must be applied full height in the vertical orientation to each stud flange and installed in accordance with ASTM C754 using minimum No. 6 Type S Drywall screws spaced as listed below:
 - Sheathing screws spaced a maximum of 16 in on-center to framing members (including bottom track) when studs spaced at 16 in or 12 in on-center.
 - Sheathing screws spaced a maximum of 12 in on-center to framing members (including bottom track) when studs spaced at 24 in on-center.
 - No fasteners are required for attaching the stud to the Deflection track at the top except as detailed in ASTM C754.:
 - Stud to track connection must be installed as depicted in figure with a maximum gap of 7/8" between the web of the Deflection track and end of stud.
 - The maximum amount of total vertical movement (compression + extension) cannot exceed 1-1/2".
 - To permit head of wall deflection, gypsum board must not be fastened directly to the Deflection track.
 - No fasteners are required for attaching the stud to the bottom track except as detailed in ASTM C754.
 - A spazzer spacing bar shall be installed in the punchouts immediately adjacent to the top track (Deflection Track) to hold studs in place.
- f** Adjacent to the height value indicates that flexural stress controls the allowable wall height.

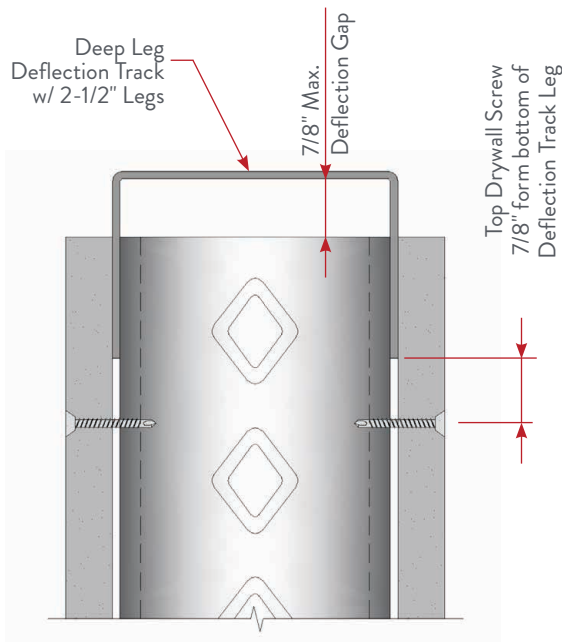

ProSTUD® 20 / 18mil Head-of-Wall (HOW) Composite Limiting Heights
 w/ 30mil 2-1/2" Leg Deflection Track 5/8" Type X Gypsum Board

Width	Stud Member	Yield Strength	Spacing (in) o.c.	5psf			7.5psf			10psf		
				L/120	L/240	L/360	L/120	L/240	L/360	L/120	L/240	L/360
2-1/2"	ProSTUD 20 / 18 mil 250PDS125-18	70 ksi	12	16'-6"	14'-1"	12'-4"	14'-6"	12'-4"	10'-9"	13'-3"	11'-2"	9'-9"
			16	15'-11"	13'-5"	11'-8"	13'-11"	11'-8"	10'-3"	12'-8"	10'-8"	9'-0"
			24	14'-5"	12'-2"	10'-7"	12'-6" f	10'-7"	8'-11"	10'-10" f	9'-6"	–
3-5/8"	ProSTUD 20 / 18 mil 362PDS125-18	70 ksi	12	21'-2"	17'-8"	15'-5"	18'-6"	15'-6"	13'-5"	16'-10"	14'-1"	12'-3"
			16	19'-11"	16'-8"	14'-6"	17'-5"	14'-7"	12'-8"	15'-10"	13'-3"	11'-3"
			24	18'-0"	14'-11"	13'-0"	15'-9"	13'-1"	11'-1"	13'-7" f	11'-10"	9'-9"
4"	ProSTUD 20 / 18 mil 400PDS125-18	70 ksi	12	22'-5"	18'-7"	16'-4"	19'-7"	16'-3"	14'-3"	17'-10"	14'-9"	12'-11"
			16	20'-10"	17'-3"	15'-2"	18'-3"	15'-1"	13'-3"	16'-7"	13'-9"	12'-1"
			24	18'-7"	15'-5"	13'-6"	16'-3"	13'-6"	11'-9"	14'-2" f	12'-3"	10'-2"
6"	ProSTUD 20 / 18 mil 600PDS125-18	70 ksi	12	29'-6"	24'-8"	21'-9"	25'-9"	21'-6"	19'-0"	22'-5" f	19'-7"	17'-3"
			16	27'-9"	23'-2"	20'-5"	23'-4" f	20'-3"	17'-10"	20'-3" f	18'-5"	16'-2"
			24	24'-3" f	20'-11"	18'-3"	19'-10" f	18'-3"	15'-11"	17'-2" f	16'-7"	13'-8"

Notes:

- Allowable HOW composite limiting heights were tested in accordance with AISI S916 and ICC-ES AC86.
- The tests were modified from the standards with the tracks fastened to the test fixture such that the wall stiffness included the track deformation.
- In accordance with current building codes and AISI design standards, the 1/3 Stress Increase for strength was not used.
- The composite limiting heights provided in the tables are based on a single layer of 5/8" Type X Gypsum Board from the following manufacturers: American, CertainTeed, Georgia Pacific, Continental, National, PABCO, and USG.
- The gypsum board must be applied full height in the vertical orientation to each stud flange and installed in accordance with ASTM C754 using minimum No. 6 Type S Drywall screws spaced as listed below:
 - Sheathing screws spaced a maximum of 16 in on-center to framing members (including bottom track) when studs spaced at 16 in or 12 in on-center.
 - Sheathing screws spaced a maximum of 12 in on-center to framing members (including bottom track) when studs spaced at 24 in on-center.
- No fasteners are required for attaching the stud to the Deflection track at the top except as detailed in ASTM C754.:
 - Stud to track connection must be installed as depicted in figure with a maximum gap of 7/8" between the web of the Deflection track and end of stud.
 - The maximum amount of total vertical movement (compression + extension) cannot exceed 1-1/2".
 - To permit head of wall deflection, gypsum board must not be fastened directly to the Deflection track.
- No fasteners are required for attaching the stud to the bottom track except as detailed in ASTM C754.
- A spazer spacing bar shall be installed in the punchouts immediately adjacent to the top track (Deflection Track) to hold studs in place.
- f** Adjacent to the height value indicates that flexural stress controls the allowable wall height.

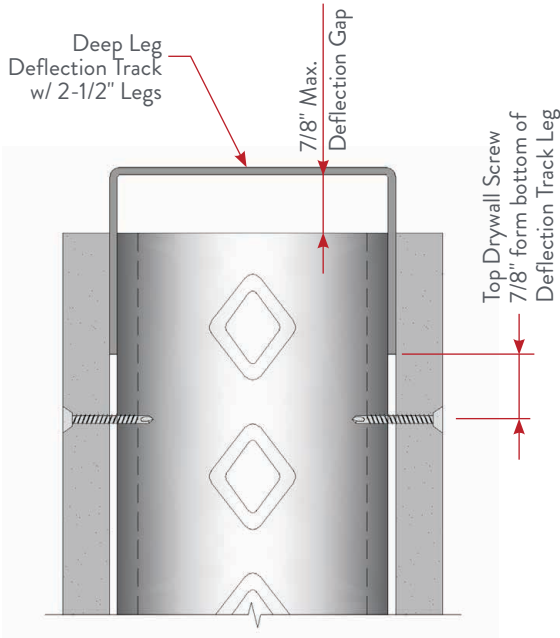

Complies with IBC 2024 • AISI S100 • AISI S220

ProSTUD® 30mil Head-of-Wall (HOW) Composite Limiting Heights
w/ 30mil 2-1/2" Leg Deflection Track

5/8" Type X Gypsum Board

Width	Stud Member	Yield Strength	Spacing (in) o.c.	5psf			7.5psf			10psf		
				L/120	L/240	L/360	L/120	L/240	L/360	L/120	L/240	L/360
2-1/2"	ProSTUD 30 mil 250PDS125-30	33 ksi	12	17'-10"	14'-10"	13'-0"	15'-7"	13'-0"	11'-4"	14'-2"	11'-10"	10'-4"
			16	16'-7"	13'-10"	12'-1"	14'-6"	12'-1"	10'-6"	13'-2"	11'-0"	9'-5"
			24	14'-10"	12'-4"	10'-9"	13'-0"	10'-9"	9'-2"	11'-9"	9'-8"	8'-1"
3-5/8"	ProSTUD 30 mil 362PDS125-30	33 ksi	12	23'-11"	19'-8"	17'-2"	20'-10"	17'-2"	15'-0"	19'-0"	15'-7"	13'-8"
			16	22'-3"	18'-4"	16'-1"	19'-6"	16'-1"	14'-0"	17'-8"	14'-7"	12'-8"
			24	19'-11"	16'-2"	14'-2"	17'-5"	14'-2"	12'-3"	15'-10"	12'-10"	11'-0"
4"	ProSTUD 30 mil 400PDS125-30	33 ksi	12	25'-5"	20'-8"	18'-1"	22'-2"	18'-1"	15'-9"	20'-2"	16'-5"	14'-4"
			16	23'-7"	19'-3"	16'-10"	20'-7"	16'-10"	14'-8"	18'-8"	15'-3"	13'-4"
			24	21'-0"	17'-2"	15'-0"	18'-4"	15'-0"	13'-1"	16'-8"	13'-7"	11'-8"
6"	ProSTUD 30 mil 600PDS125-30	33 ksi	12	33'-1"	28'-2"	24'-9"	28'-11"	24'-7"	21'-8"	26'-3"	22'-4"	19'-8"
			16	30'-8"	26'-2"	23'-0"	26'-10"	22'-10"	20'-1"	24'-4"	20'-9"	18'-3"
			24	27'-4"	23'-1"	20'-2"	23'-11"	20'-2"	17'-7"	20'-9" f	18'-4"	—

Notes:

- Allowable HOW composite limiting heights were tested in accordance with AISI S916 and ICC-ES AC86.
 - The tests were modified from the standards with the tracks fastened to the test fixture such that the wall stiffness included the track deformation.
 - In accordance with current building codes and AISI design standards, the 1/3 Stress Increase for strength was not used.
 - The composite limiting heights provided in the tables are based on a single layer of 5/8" Type X Gypsum Board from the following manufacturers: American, CertainTeed, Georgia Pacific, Continental, National, PABCO, and USG.
 - The gypsum board must be applied full height in the vertical orientation to each stud flange and installed in accordance with ASTM C754 using minimum No. 6 Type S Drywall screws spaced as listed below:
 - Sheathing screws spaced a maximum of 16 in on-center to framing members (including bottom track) when studs spaced at 16 in or 12 in on-center.
 - Sheathing screws spaced a maximum of 12 in on-center to framing members (including bottom track) when studs spaced at 24 in on-center.
 - No fasteners are required for attaching the stud to the Deflection track at the top except as detailed in ASTM C754.:
 - Stud to track connection must be installed as depicted in figure with a maximum gap of 7/8" between the web of the Deflection track and end of stud.
 - To permit head of wall deflection, gypsum board must not be fastened directly to the Deflection track.
 - No fasteners are required for attaching the stud to the bottom track except as detailed in ASTM C754.
 - A spazzer spacing bar shall be installed in the punchouts immediately adjacent to the top track (Deflection Track) to hold studs in place.
- f** Adjacent to the height value indicates that flexural stress controls the allowable wall height.

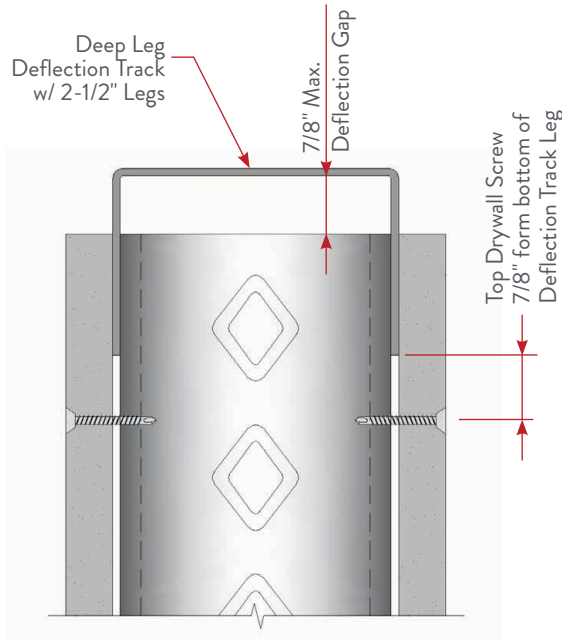

Complies with IBC 2024 • AISI S100 • AISI S220

ProSTUD® 33mil Head-of-Wall (HOW) Composite Limiting Heights w/ 30mil 2-1/2" Leg Deflection Track				5/8" Type X Gypsum Board								
Width	Stud Member	Yield Strength	Spacing (in) o.c.	5psf			7.5psf			10psf		
				L/120	L/240	L/360	L/120	L/240	L/360	L/120	L/240	L/360
2-1/2"	ProSTUD 33 mil 250PDS125-33	33 ksi	12	18'-9"	14'-10"	13'-0"	16'-4"	13'-0"	11'-4"	14'-10"	11'-10"	10'-4"
			16	17'-4"	13'-10"	12'-1"	15'-2"	12'-1"	10'-6"	13'-9"	11'-0"	9'-5"
			24	15'-5"	12'-4"	10'-9"	13'-6"	10'-9"	9'-2"	12'-3"	9'-8"	8'-1"
3-5/8"	ProSTUD 33 mil 362PDS125-33	33 ksi	12	24'-2"	19'-8"	17'-2"	21'-1"	17'-2"	15'-0"	19'-2"	15'-7"	13'-8"
			16	22'-6"	18'-4"	16'-1"	19'-8"	16'-1"	14'-0"	17'-10"	14'-7"	12'-8"
			24	20'-1"	16'-5"	14'-4"	17'-7"	14'-4"	12'-5"	15'-11"	13'-1"	11'-1"
4"	ProSTUD 33 mil 400PDS125-33	33 ksi	12	25'-7"	20'-8"	18'-1"	22'-5"	18'-1"	15'-9"	20'-4"	16'-5"	14'-4"
			16	23'-10"	19'-3"	16'-10"	20'-10"	16'-10"	14'-8"	18'-11"	15'-3"	13'-4"
			24	21'-4"	17'-2"	15'-0"	18'-8"	15'-0"	13'-1"	16'-11"	13'-8"	11'-8"
6"	ProSTUD 33 mil 600PDS125-33	33 ksi	12	34'-5"	28'-2"	24'-11"	30'-1"	24'-7"	21'-9"	27'-4"	22'-4"	19'-9"
			16	32'-1"	26'-2"	23'-2"	28'-0"	22'-11"	20'-3"	25'-5"	20'-10"	18'-5"
			24	28'-8"	23'-5"	20'-8"	25'-0"	20'-6"	18'-1"	22'-9" f	18'-7"	16'-4"

Notes:

- Allowable HOW composite limiting heights were tested in accordance with AISI S916 and ICC-ES AC86.
- The tests were modified from the standards with the tracks fastened to the test fixture such that the wall stiffness included the track deformation.
- In accordance with current building codes and AISI design standards, the 1/3 Stress Increase for strength was not used.
- The composite limiting heights provided in the tables are based on a single layer of 5/8" Type X Gypsum Board from the following manufacturers: American, CertainTeed, Georgia Pacific, Continental, National, PABCO, and USG.
- The gypsum board must be applied full height in the vertical orientation to each stud flange and installed in accordance with ASTM C754 using minimum No. 6 Type S Drywall screws spaced as listed below:
 - Sheathing screws spaced a maximum of 16 in on-center to framing members (including bottom track) when studs spaced at 16 in or 12 in on-center.
 - Sheathing screws spaced a maximum of 12 in on-center to framing members (including bottom track) when studs spaced at 24 in on-center.
- No fasteners are required for attaching the stud to the Deflection track at the top except as detailed in ASTM C754.
 - Stud to track connection must be installed as depicted in figure with a maximum gap of 7/8" between the web of the Deflection track and end of stud.
 - To permit head of wall deflection, gypsum board must not be fastened directly to the Deflection track.
- No fasteners are required for attaching the stud to the bottom track except as detailed in ASTM C754.
- A spazzer spacing bar shall be installed in the punchouts immediately adjacent to the top track (Deflection Track) to hold studs in place.
- f** Adjacent to the height value indicates that flexural stress controls the allowable wall height.

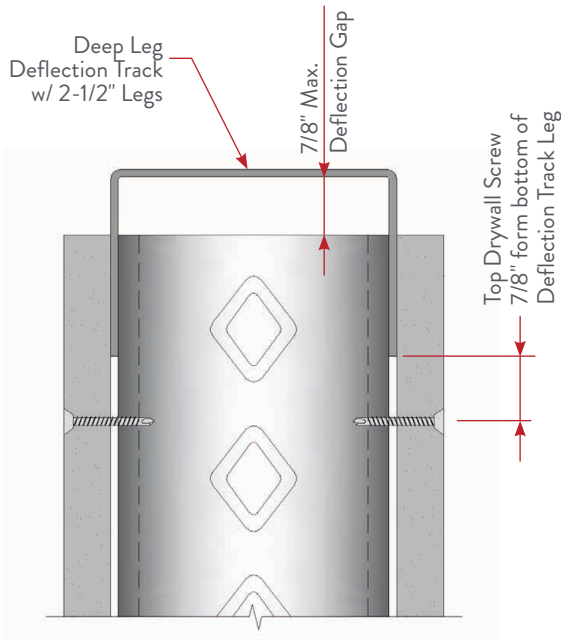

Complies with IBC 2024 • AISI S100 • AISI S220

ProSTUD® Full Composite Limiting Heights

5/8" Type X Gypsum Board

Width (in)	Stud member	Design thickness (in)	Yield strength (ksi)	Spacing (inches)	Lateral Load (psf)								
					5psf			7.5psf			10psf		
					L/120	L/240	L/360	L/120	L/240	L/360	L/120	L/240	L/360
1-5/8	ProSTUD 25 162PDS125-15	0.0158	50	12	14'-1"	11'-7"	10'-1"	12'-3"	10'-1"	8'-7"	11'-2"	9'-1"	—
				16	12'-9"	10'-6"	9'-0"	11'-2"	9'-1"	—	10'-2"	8'-1"	—
				24	11'-2"	9'-1"	—	9'-9"	—	—	8'-5"	—	—
	ProSTUD 20 162PDS125-18	0.0190	70	12	13'-2"	11'-5"	10'-0"	11'-6"	10'-0"	8'-5"	10'-6"	8'-9"	—
				16	12'-10"	11'-1"	9'-9"	11'-2"	9'-8"	7'-11"	10'-2"	8'-4"	—
				24	11'-10"	10'-3"	8'-6"	10'-4"	8'-5"	—	9'-2"	—	—
	ProSTUD 30 162PDS125-30	0.0312	33	12	16'-3"	12'-11"	11'-3"	14'-3"	11'-3"	9'-10"	12'-11"	10'-3"	8'-8"
				16	14'-9"	11'-9"	10'-3"	12'-11"	10'-3"	8'-8"	11'-9"	9'-2"	—
				24	12'-11"	10'-3"	8'-8"	11'-3"	8'-8"	—	10'-3"	—	—
	ProSTUD 33 162PDS125-33	0.0346	33	12	17'-0"	13'-6"	11'-10"	14'-10"	11'-10"	10'-4"	13'-6"	10'-9"	9'-3"
				16	15'-6"	12'-3"	10'-9"	13'-6"	10'-9"	9'-3"	12'-3"	9'-9"	—
				24	13'-6"	10'-9"	9'-3"	11'-10"	9'-3"	—	10'-9"	—	—
2-1/2	ProSTUD 25 250PDS125-15	0.0158	50	12	17'-2"	14'-8"	13'-0"	15'-0"	12'-10"	11'-4"	13'-3" f	11'-8"	10'-4"
				16	15'-7"	13'-4"	11'-9"	13'-3" f	11'-8"	10'-4"	11'-5" f	10'-7"	9'-1"
				24	13'-3" f	11'-8"	10'-4"	10'-10" f	10'-2"	8'-6"	9'-4" f	8'-11"	—
	ProSTUD 20 250PDS125-18	0.0190	70	12	17'-5"	14'-8"	12'-11"	15'-3"	12'-10"	11'-3"	13'-10"	11'-8"	10'-3"
				16	16'-8"	14'-0"	12'-4"	14'-6"	12'-3"	10'-9"	13'-2"	11'-2" f	9'-9"
				24	15'-2"	12'-10"	11'-3"	13'-2" f	11'-2"	9'-10"	11'-5" f	10'-2"	8'-5"
	ProSTUD 30 250PDS125-30	0.0312	33	12	19'-9"	16'-3"	14'-4"	17'-3"	14'-2"	12'-6"	15'-8"	12'-11"	11'-4"
				16	17'-11"	14'-9"	13'-0"	15'-8"	12'-11"	11'-4"	14'-3"	11'-9"	10'-4"
				24	15'-8"	12'-11"	11'-4"	13'-8" f	11'-3"	9'-11"	12'-5"	10'-3"	8'-8"
	ProSTUD 33 250PDS125-33	0.0346	33	12	20'-4"	16'-9"	14'-9"	17'-9"	14'-7"	12'-10"	16'-2"	13'-3"	11'-8"
				16	18'-6"	15'-2"	13'-5"	16'-2"	13'-3"	11'-8"	14'-8"	12'-1"	10'-7"
				24	16'-2"	13'-3"	11'-8"	14'-1"	11'-7"	10'-3"	12'-10"	10'-7"	9'-1"
3-5/8	ProSTUD 25 362PDS125-15	0.0158	50	12	21'-6"	17'-1"	14'-11"	18'-4" f	14'-11"	13'-0"	15'-10" f	13'-7"	11'-10"
				16	19'-5" f	15'-6"	13'-7"	15'-10" f	13'-7"	11'-10"	13'-9" f	12'-4"	10'-7"
				24	15'-10" f	13'-7"	11'-10"	12'-11" f	11'-10"	10'-1"	11'-2" f	10'-7"	9'-0"
	ProSTUD 20 362PDS125-18	0.0190	70	12	22'-0"	18'-2"	15'-8"	19'-3"	15'-10"	13'-8"	17'-6"	14'-5"	12'-5"
				16	20'-6"	16'-10"	14'-7"	17'-11"	14'-9"	12'-9"	16'-3"	13'-5"	11'-6"
				24	18'-4"	15'-1"	13'-0"	15'-11" f	13'-2"	11'-4"	13'-9" f	12'-0"	10'-1"
	ProSTUD 30 362PDS125-30	0.0312	33	12	25'-8"	20'-5"	17'-10"	22'-5"	17'-10"	15'-7"	20'-5"	16'-2"	14'-2"
				16	23'-4"	18'-6"	16'-2"	20'-5"	16'-2"	14'-2"	18'-6"	14'-8"	12'-10"
				24	20'-5"	16'-2"	14'-2"	17'-10"	14'-2"	12'-3"	16'-2"	12'-10"	11'-0"
	ProSTUD 33 362PDS125-33	0.0346	33	12	26'-7"	21'-2"	18'-5"	23'-3"	18'-5"	16'-1"	21'-2"	16'-9"	14'-8"
				16	24'-2"	19'-2"	16'-9"	21'-2"	16'-9"	14'-8"	19'-2"	15'-3"	13'-4"
				24	21'-2"	16'-9"	14'-8"	18'-5"	14'-8"	12'-10"	16'-9"	13'-4"	11'-6"

Notes:

- Allowable composite limiting heights were tested in accordance with AISI S916 and ICC-ES AC86.
- Additional composite wall testing and analysis requirements of the SFIA Code Compliance Certification Program were also observed.
- In accordance with current building codes and AISI design standards, the 1/3 stress increase for strength was not used.
- The composite limiting heights provided in the tables are based on a single layer of 5/8" Type X Gypsum Board from the following manufacturers: American, CertainTeed, Georgia Pacific, Continental, National, PABCO, and USG.
- The gypsum board must be applied full height in the vertical orientation to each stud flange and installed in accordance with ASTM C754 using minimum No. 6 Type S drywall screws spaced as listed below:
 - Screws spaced a maximum of 16 in. o.c. to framing members (including top and bottom tracks) spaced at 16 in. or 12 in. o.c.
 - Screws spaced a maximum of 12 in. o.c. to framing members (including top and bottom tracks) spaced at 24 in. o.c.
- No fasteners are required for attaching the stud to the track except as detailed in ASTM C754.
- Stud end bearing must be a minimum of 1 inch.
- f** Adjacent to the height value indicates that flexural stress controls the allowable wall height.
- s** Adjacent to the height value indicates that shear/end reaction controls the allowable wall height.

ProSTUD® Full Composite Limiting Heights **5/8" Type X Gypsum Board**

Width (in)	Stud member	Design thickness (in)	Yield strength (ksi)	Spacing (inches)	Lateral Load (psf)									
					5psf			7.5psf			10psf			
					L/120	L/240	L/360	L/120	L/240	L/360	L/120	L/240	L/360	
4	ProSTUD 25 400PDS125-15	0.0158	50	12	22'-8"	18'-0"	15'-9"	19'-1" f	15'-9"	13'-9"	16'-6" f	14'-4"	12'-6"	
				16	20'-3" f	16'-4"	14'-4"	16'-6" f	14'-4"	12'-6"	14'-4" f	13'-0"	11'-3"	
				24	16'-6" f	14'-4"	12'-6"	13'-6" f	12'-6"	10'-8"	11'-8" f	11'-3"	9'-6"	
	ProSTUD 20 400PDS125-18	0.0190	70	12	22'-9"	18'-8"	16'-4"	19'-11"	16'-4"	14'-3"	18'-1"	14'-10"	13'-0"	
				16	21'-4"	17'-7"	15'-4"	18'-8"	15'-4"	13'-5"	16'-11"	13'-11"	12'-2"	
				24	19'-3"	15'-10"	13'-10"	16'-7" f	13'-10"	12'-1"	14'-4" f	12'-6"	10'-9"	
	ProSTUD 30 400PDS125-30	0.0312	33	12	27'-5"	21'-9"	19'-0"	19'-0"	16'-8"	16'-8"	17'-4"	15'-1"	19'-10"	15'-9"
				16	24'-11"	19'-10"	17'-4"	21'-9"	17'-4"	15'-1"	19'-10"	15'-9"	13'-9"	
				24	21'-9"	17'-4"	15'-1"	19'-0"	15'-1"	13'-2"	17'-4"	13'-9"	11'-10"	
	ProSTUD 33 400PDS125-33	0.0346	33	12	27'-10"	22'-9"	20'-1"	24'-3"	19'-11"	17'-7"	22'-1"	18'-1"	15'-11"	
				16	25'-3"	20'-8"	18'-3"	22'-1"	18'-1"	15'-11"	20'-1"	16'-5"	14'-6"	
				24	22'-1"	18'-1"	15'-11"	19'-3"	15'-10"	13'-11"	17'-6"	14'-4"	12'-8"	
6	ProSTUD 25 600PDS125-15	0.0158	50	12	27'-10" f	24'-2"	21'-5"	22'-9" f	21'-1"	18'-8"	19'-8" f	19'-2"	17'-0"	
				16	24'-1" f	21'-11"	19'-5"	19'-8" f	19'-2"	17'-0"	17'-1" f	17'-1" f	15'-5"	
				24	19'-8" f	19'-2"	17'-0"	16'-1" f	16'-1" f	14'-9"	13'-11" f	13'-11" f	13'-4"	
	ProSTUD 20 600PDS125-18	0.0190	70	12	32'-1"	25'-6"	22'-3"	28'-1"	22'-3"	19'-5"	24'-4" f	20'-3"	17'-8"	
				16	29'-10"	23'-8"	20'-8"	24'-10" f	20'-8"	18'-1"	21'-6" f	18'-9"	16'-5"	
				24	25'-5" f	21'-1"	18'-5"	20'-9" f	18'-5"	16'-1"	18'-0" f	16'-9"	14'-6"	
	ProSTUD 30 600PDS125-30	0.0312	33	12	36'-7"	29'-1"	25'-5"	32'-0"	25'-5"	22'-2"	29'-1"	23'-1"	20'-2"	
				16	33'-3"	26'-5"	23'-1"	29'-1"	23'-1"	20'-2"	26'-5"	20'-11"	18'-4"	
				24	29'-1"	23'-1"	20'-2"	25'-5"	20'-2"	17'-7"	22'-6" f	18'-4"	—	
	ProSTUD 33 600PDS125-33	0.0346	33	12	36'-8"	30'-1"	26'-6"	32'-0"	26'-3"	23'-2"	29'-1"	23'-10"	21'-0"	
				16	33'-3"	27'-4"	24'-1"	29'-1"	23'-10"	21'-0"	26'-5"	21'-8"	19'-1"	
				24	29'-1"	23'-10"	21'-0"	25'-5"	20'-10"	18'-4"	23'-1"	18'-11"	—	

Notes:

- Allowable composite limiting heights were tested in accordance with AISI S916 and ICC-ES AC86.
- Additional composite wall testing and analysis requirements of the SFIA Code Compliance Certification Program were also observed.
- In accordance with current building codes and AISI design standards, the 1/3 stress increase for strength was not used.
- The composite limiting heights provided in the tables are based on a single layer of 5/8" Type X Gypsum Board from the following manufacturers: American, CertainTeed, Georgia Pacific, Continental, National, PABCO, and USG.
- The gypsum board must be applied full height in the vertical orientation to each stud flange and installed in accordance with ASTM C754 using minimum No. 6 Type S drywall screws spaced as listed below:
 - Screws spaced a maximum of 16 in. o.c. to framing members (including top and bottom tracks) spaced at 16 in. or 12 in. o.c.
 - Screws spaced a maximum of 12 in. o.c. to framing members (including top and bottom tracks) spaced at 24 in. o.c.
- No fasteners are required for attaching the stud to the track except as detailed in ASTM C754.
- Stud end bearing must be a minimum of 1 inch.
- f** Adjacent to the height value indicates that flexural stress controls the allowable wall height.
- s** Adjacent to the height value indicates that shear/end reaction controls the allowable wall height.

ProSTUD® Non-Composite Limiting Heights

ClarkDietrich ProSTUD Non-Composite Limiting Heights—FULLY BRACED

Depth (in)	Stud member	Design thickness (in)	Yield strength (ksi)	Spacing o.c. (in)	Lateral Load (psf)									
					5psf			7.5psf			10psf			
					L/120	L/240	L/360	L/120	L/240	L/360	L/120	L/240	L/360	
1-5/8	ProSTUD 25 162PDS125-15	0.0158	50	12	9'-2"	7'-4"	6'-4"	8'-0"	6'-4"	5'-7"	6'-11"	5'-9"	5'-1"	
		0.0158	50	16	8'-4"	6'-8"	5'-9"	6'-11"	5'-9"	5'-1"	6'-0"	5'-3"	4'-7"	
		0.0158	50	24	6'-11"	5'-9"	5'-1"	5'-8"	5'-1"	4'-5"	4'-11"	4'-7"	4'-0"	
	ProSTUD 20 162PDS125-18	0.0190	70	12	9'-9"	7'-9"	6'-9"	8'-6"	6'-9"	5'-11"	7'-9"	6'-2"	5'-4"	5'-4"
		0.0190	70	16	8'-10"	7'-0"	6'-2"	7'-9"	6'-2"	5'-4"	7'-0"	5'-7"	4'-10"	4'-10"
		0.0190	70	24	7'-9"	6'-2"	5'-4"	6'-9"	5'-4"	4'-8"	6'-2"	4'-10"	4'-3"	4'-3"
	ProSTUD 30MIL 162PDS125-30	0.0312	33	12	11'-10"	9'-5"	8'-3"	10'-4"	8'-3"	7'-2"	9'-5"	7'-6"	6'-6"	6'-6"
		0.0312	33	16	10'-9"	8'-7"	7'-6"	9'-5"	7'-6"	6'-6"	8'-2"	6'-9"	5'-11"	5'-11"
		0.0312	33	24	9'-5"	7'-6"	6'-6"	7'-8"	6'-6"	5'-8"	6'-8"	5'-11"	5'-2"	5'-2"
	ProSTUD 33MIL 162PDS125-33	0.0346	33	12	12'-3"	9'-9"	8'-6"	10'-8"	8'-6"	7'-5"	9'-9"	7'-9"	6'-9"	6'-9"
		0.0346	33	16	11'-2"	8'-10"	7'-9"	9'-9"	7'-9"	6'-9"	8'-9"	7'-0"	6'-1"	6'-1"
		0.0346	33	24	9'-9"	7'-9"	6'-9"	8'-3"	6'-9"	5'-11"	7'-2"	6'-1"	5'-4"	5'-4"
2-1/2	ProSTUD 25 250PDS125-15	0.0158	50	12	12'-8"	10'-2"	8'-11"	10'-4"	8'-11"	7'-9"	8'-11"	8'-1"	7'-1"	
		0.0158	50	16	10'-11"	9'-3"	8'-1"	8'-11"	8'-1"	7'-1"	7'-9"	7'-4"	6'-5"	
		0.0158	50	24	8'-11"	8'-1"	7'-1"	7'-4"	7'-1"	6'-2"	6'-4"	6'-4"	5'-7"	
	ProSTUD 20 250PDS125-18	0.0190	70	12	13'-9"	10'-11"	9'-6"	12'-0"	9'-6"	8'-4"	10'-11"	8'-8"	7'-7"	7'-7"
		0.0190	70	16	12'-6"	9'-11"	8'-8"	10'-11"	8'-8"	7'-7"	9'-11"	7'-10"	6'-10"	6'-10"
		0.0190	70	24	10'-11"	8'-8"	7'-7"	9'-6"	7'-7"	6'-7"	8'-4"	6'-10"	6'-0"	6'-0"
	ProSTUD 30MIL 250PDS125-30	0.0312	33	12	16'-5"	13'-0"	11'-4"	14'-4"	11'-4"	9'-11"	12'-6"	10'-4"	9'-0"	9'-0"
		0.0312	33	16	14'-11"	11'-10"	10'-4"	12'-6"	10'-4"	9'-0"	10'-10"	9'-5"	8'-2"	8'-2"
		0.0312	33	24	12'-6"	10'-4"	9'-0"	10'-3"	9'-0"	7'-11"	8'-10"	8'-2"	7'-2"	7'-2"
	ProSTUD 33MIL 250PDS125-33	0.0346	33	12	16'-11"	13'-5"	11'-9"	14'-10"	11'-9"	10'-3"	13'-5"	10'-8"	9'-4"	9'-4"
		0.0346	33	16	15'-5"	12'-3"	10'-8"	13'-5"	10'-8"	9'-4"	11'-7"	9'-8"	8'-6"	8'-6"
		0.0346	33	24	13'-5"	10'-8"	9'-4"	10'-11"	9'-4"	8'-2"	9'-6"	8'-6"	7'-5"	7'-5"
3-5/8	ProSTUD 25* 362PDS125-15	0.0158	50	12	15'-0"	13'-7"	11'-10"	12'-3"	11'-10"	10'-4"	10'-7"	10'-7"	9'-5"	
		0.0158	50	16	13'-0"	12'-4"	10'-9"	10'-7"	10'-7"	9'-5"	9'-2"	9'-2"	8'-6"	
		0.0158	50	24	10'-7"	10'-7"	9'-5"	8'-8"	8'-8"	8'-3"	7'-6"	7'-6"	7'-5"	
	ProSTUD 20 362PDS125-18	0.0190	70	12	18'-4"	14'-6"	12'-8"	16'-0"	12'-8"	11'-1"	14'-5"	11'-6"	10'-1"	10'-1"
		0.0190	70	16	16'-8"	13'-2"	11'-6"	14'-5"	11'-6"	10'-1"	12'-5"	10'-6"	9'-2"	9'-2"
		0.0190	70	24	14'-5"	11'-6"	10'-1"	11'-9"	10'-1"	8'-10"	10'-2"	9'-2"	8'-0"	8'-0"
	ProSTUD 30MIL 362PDS125-30	0.0312	33	12	21'-2"	17'-4"	15'-2"	17'-3"	15'-2"	13'-3"	15'-0"	13'-9"	12'-0"	12'-0"
		0.0312	33	16	18'-4"	15'-9"	13'-9"	15'-0"	13'-9"	12'-0"	12'-11"	12'-6"	10'-11"	10'-11"
		0.0312	33	24	15'-0"	13'-9"	12'-0"	12'-3"	12'-0"	10'-6"	10'-7"	10'-7"	9'-6"	9'-6"
	ProSTUD 33MIL 362PDS125-33	0.0346	33	12	22'-7"	17'-11"	15'-8"	18'-9"	15'-8"	13'-8"	16'-3"	14'-3"	12'-5"	12'-5"
		0.0346	33	16	19'-10"	16'-3"	14'-3"	16'-3"	14'-3"	12'-5"	14'-0"	12'-11"	11'-3"	11'-3"
		0.0346	33	24	16'-3"	14'-3"	12'-5"	13'-3"	12'-5"	10'-10"	11'-6"	11'-3"	9'-10"	9'-10"
4	ProSTUD 25* 400PDS125-15	0.0158	50	12	15'-9"	14'-6"	12'-8"	12'-11"	12'-8"	11'-1"	11'-2"	11'-2"	10'-1"	
		0.0158	50	16	13'-8"	13'-2"	11'-6"	11'-2"	11'-2"	10'-1"	9'-8"	9'-8"	9'-2"	
		0.0158	50	24	11'-2"	11'-2"	10'-1"	9'-1"	9'-1"	8'-9"	7'-11"	7'-11"	7'-11"	
	ProSTUD 20* 400PDS125-18	0.0190	70	12	19'-7"	15'-6"	13'-7"	17'-1"	13'-7"	11'-10"	15'-4"	12'-4"	10'-9"	10'-9"
		0.0190	70	16	17'-9"	14'-1"	12'-4"	15'-4"	12'-4"	10'-9"	13'-3"	11'-2"	9'-9"	9'-9"
		0.0190	70	24	15'-4"	12'-4"	10'-9"	12'-6"	10'-9"	9'-5"	10'-10"	9'-9"	8'-7"	8'-7"
	ProSTUD 30MIL 400PDS125-30	0.0312	33	12	22'-4"	18'-8"	16'-4"	18'-3"	16'-4"	14'-3"	15'-9"	14'-10"	13'-0"	13'-0"
		0.0312	33	16	19'-4"	17'-0"	14'-10"	15'-9"	14'-10"	13'-0"	13'-8"	13'-6"	11'-9"	11'-9"
		0.0312	33	24	15'-9"	14'-10"	13'-0"	12'-11"	12'-11"	11'-4"	11'-2"	11'-2"	10'-3"	10'-3"
	ProSTUD 33MIL 400PDS125-33	0.0346	33	12	24'-2"	19'-4"	16'-11"	19'-9"	16'-11"	14'-9"	17'-1"	15'-4"	13'-5"	13'-5"
		0.0346	33	16	21'-0"	17'-7"	15'-4"	17'-1"	15'-4"	13'-5"	14'-10"	13'-11"	12'-2"	12'-2"
		0.0346	33	24	17'-1"	15'-4"	13'-5"	14'-0"	13'-5"	11'-9"	12'-1"	12'-1"	10'-8"	10'-8"
6	ProSTUD 25* 600PDS125-15	0.0158	50	12	19'-3"	19'-2"	16'-9"	15'-9"	15'-9"	14'-8"	11'-11"	11'-11"	11'-11"	
		0.0158	50	16	16'-8"	16'-8"	15'-3"	11'-11"	11'-11"	11'-11"	8'-11"	8'-11"	8'-11"	
		0.0158	50	24	11'-11"	11'-11"	11'-11"	7'-11"	7'-11"	7'-11"	6'-0"	6'-0"	6'-0"	
	ProSTUD 20* 600PDS125-18	0.0190	70	12	26'-0"	20'-8"	18'-0"	21'-11"	18'-0"	15'-9"	19'-0"	16'-4"	14'-4"	14'-4"
		0.0190	70	16	23'-3"	18'-9"	16'-4"	19'-0"	16'-4"	14'-4"	15'-7"	14'-11"	13'-0"	13'-0"
		0.0190	70	24	19'-0"	16'-4"	14'-4"	13'-10"	13'-10"	12'-6"	10'-5"	10'-5"	10'-5"	
	ProSTUD 30MIL 600PDS125-30	0.0312	33	12	28'-4"	25'-7"	22'-4"	23'-2"	22'-4"	19'-7"	20'-1"	20'-1"	17'-9"	17'-9"
		0.0312	33	16	24'-7"	23'-3"	20'-4"	20'-1"	20'-1"	17'-9"	17'-4"	17'-4"	16'-2"	16'-2"
		0.0312	33	24	20'-1"	20'-1"	17'-9"	16'-4"	16'-4"	15'-6"	14'-2"	14'-2"	14'-1"	14'-1"
	ProSTUD 33MIL 600PDS125-33	0.0346	33	12	30'-7"	26'-7"	23'-2"	25'-0"	23'-2"	20'-3"	21'-8"	21'-1"	18'-5"	18'-5"
		0.0346	33	16	26'-6"	24'-1"	21'-1"	21'-8"	21'-1"	18'-5"	18'-9"	18'-9"	16'-9"	16'-9"
		0.0346	33	24	21'-8"	21'-1"	18'-5"	17'-8"	17'-8"	16'-1"	15'-4"	15'-4"	14'-7"	14'-7"

Notes:

- Calculated properties are based on AISI S100-16 (2020) w/S2-20 North American Specification for Design of Cold-Formed Steel Structural Members and AISI S220-20 North American Standard for Cold-Formed Steel Framing—Nonstructural Members, using steel properties alone.
- Above listed Non-Composite Limiting Heights are applicable when the unbraced length is less than or equal to L_u.
- Heights are limited by moment, deflection, shear, and web crippling (assuming 1" end reaction bearing).
- * Web stiffeners are required at bearing points.

Complies with IBC 2024 • AISI S100 • AISI S220

ProSTUD® Non-Composite Limiting Heights					ClarkDietrich ProSTUD Non-Composite Limiting Heights—BRACED AT 48" o.c.								
Depth (in)	Stud member	Design thickness (in)	Yield strength (ksi)	Spacing o.c. (in)	Lateral Load (psf)								
					5psf			7.5psf			10psf		
					L/120	L/240	L/360	L/120	L/240	L/360	L/120	L/240	L/360
1-5/8	ProSTUD 25 162PDS125-15	0.0158	50	12	8'-1"	7'-4"	6'-4"	6'-7"	6'-4"	5'-7"	5'-9"	5'-9"	5'-1"
		0.0158	50	16	7'-0"	6'-8"	5'-9"	5'-9"	5'-9"	5'-1"	4'-11"	4'-11"	4'-7"
		0.0158	50	24	5'-9"	5'-9"	5'-1"	4'-8"	4'-8"	4'-5"	4'-0"	4'-0"	4'-0"
	ProSTUD 20 162PDS125-18	0.0190	70	12	9'-6"	7'-9"	6'-9"	7'-9"	6'-9"	5'-11"	6'-9"	6'-2"	5'-4"
		0.0190	70	16	8'-3"	7'-0"	6'-2"	6'-9"	6'-2"	5'-4"	5'-10"	5'-7"	4'-10"
		0.0190	70	24	6'-9"	6'-2"	5'-4"	5'-6"	5'-4"	4'-8"	4'-9"	4'-9"	4'-3"
	ProSTUD 30MIL 162PDS125-30	0.0312	33	12	11'-10"	9'-5"	8'-3"	10'-3"	8'-3"	7'-2"	8'-11"	7'-6"	6'-6"
		0.0312	33	16	10'-9"	8'-7"	7'-6"	8'-11"	7'-6"	6'-6"	7'-8"	6'-9"	5'-11"
		0.0312	33	24	8'-11"	7'-6"	6'-6"	7'-3"	6'-6"	5'-8"	6'-3"	5'-11"	5'-2"
	ProSTUD 33MIL 162PDS125-33	0.0346	33	12	12'-3"	9'-9"	8'-6"	10'-8"	8'-6"	7'-5"	9'-5"	7'-9"	6'-9"
		0.0346	33	16	11'-2"	8'-10"	7'-9"	9'-5"	7'-9"	6'-9"	8'-2"	7'-0"	6'-1"
		0.0346	33	24	9'-5"	7'-9"	6'-9"	7'-8"	6'-9"	5'-11"	6'-8"	6'-1"	5'-4"
2-1/2	ProSTUD 25 250PDS125-15	0.0158	50	12	10'-5"	10'-2"	8'-11"	8'-6"	8'-6"	7'-9"	7'-4"	7'-4"	7'-1"
		0.0158	50	16	9'-0"	9'-0"	8'-1"	7'-4"	7'-4"	7'-1"	6'-5"	6'-5"	6'-5"
		0.0158	50	24	7'-4"	7'-4"	7'-1"	6'-0"	6'-0"	6'-0"	5'-3"	5'-3"	5'-3"
	ProSTUD 20 250PDS125-18	0.0190	70	12	13'-5"	10'-11"	9'-6"	10'-11"	9'-6"	8'-4"	9'-6"	8'-8"	7'-7"
		0.0190	70	16	11'-7"	9'-11"	8'-8"	9'-6"	8'-8"	7'-7"	8'-3"	7'-10"	6'-10"
		0.0190	70	24	9'-6"	8'-8"	7'-7"	7'-9"	7'-7"	6'-7"	6'-8"	6'-8"	6'-0"
	ProSTUD 30MIL 250PDS125-30	0.0312	33	12	16'-5"	13'-0"	11'-4"	13'-8"	11'-4"	9'-11"	11'-10"	10'-4"	9'-0"
		0.0312	33	16	14'-6"	11'-10"	10'-4"	11'-10"	10'-4"	9'-0"	10'-3"	9'-5"	8'-2"
		0.0312	33	24	11'-10"	10'-4"	9'-0"	9'-8"	9'-0"	7'-11"	8'-4"	8'-2"	7'-2"
	ProSTUD 33MIL 250PDS125-33	0.0346	33	12	16'-11"	13'-5"	11'-9"	14'-4"	11'-9"	10'-3"	12'-5"	10'-8"	9'-4"
		0.0346	33	16	15'-3"	12'-3"	10'-8"	12'-5"	10'-8"	9'-4"	10'-9"	9'-8"	8'-6"
		0.0346	33	24	12'-5"	10'-8"	9'-4"	10'-2"	9'-4"	8'-2"	8'-10"	8'-6"	7'-5"
3-5/8	ProSTUD 25* 362PDS125-15	0.0158	50	12	12'-5"	12'-5"	11'-10"	10'-1"	10'-1"	10'-1"	8'-9"	8'-9"	8'-9"
		0.0158	50	16	10'-9"	10'-9"	10'-9"	8'-9"	8'-9"	8'-9"	7'-7"	7'-7"	7'-7"
		0.0158	50	24	8'-9"	8'-9"	8'-9"	7'-2"	7'-2"	7'-2"	6'-2"	6'-2"	6'-2"
	ProSTUD 20 362PDS125-18	0.0190	70	12	15'-2"	14'-6"	12'-8"	12'-5"	12'-5"	11'-1"	10'-9"	10'-9"	10'-1"
		0.0190	70	16	13'-2"	13'-2"	11'-6"	10'-9"	10'-9"	10'-1"	9'-4"	9'-4"	9'-2"
		0.0190	70	24	10'-9"	10'-9"	10'-1"	8'-9"	8'-9"	8'-9"	7'-7"	7'-7"	7'-7"
	ProSTUD 30MIL 362PDS125-30	0.0312	33	12	20'-0"	17'-4"	15'-2"	16'-4"	15'-2"	13'-3"	14'-1"	13'-9"	12'-0"
		0.0312	33	16	17'-3"	15'-9"	13'-9"	14'-1"	13'-9"	12'-0"	12'-3"	12'-3"	10'-11"
		0.0312	33	24	14'-1"	13'-9"	12'-0"	11'-6"	11'-6"	10'-6"	10'-0"	10'-0"	9'-6"
	ProSTUD 33MIL 362PDS125-33	0.0346	33	12	21'-3"	17'-11"	15'-8"	17'-4"	15'-8"	13'-8"	15'-0"	14'-3"	12'-5"
		0.0346	33	16	18'-5"	16'-3"	14'-3"	15'-0"	14'-3"	12'-5"	13'-0"	12'-11"	11'-3"
		0.0346	33	24	15'-0"	14'-3"	12'-5"	12'-3"	12'-3"	10'-10"	10'-8"	10'-8"	9'-10"
4	ProSTUD 25* 400PDS125-15	0.0158	50	12	13'-0"	13'-0"	12'-8"	10'-8"	10'-8"	10'-8"	9'-2"	9'-2"	9'-2"
		0.0158	50	16	11'-3"	11'-3"	11'-3"	9'-2"	9'-2"	9'-2"	8'-0"	8'-0"	8'-0"
		0.0158	50	24	9'-2"	9'-2"	9'-2"	7'-6"	7'-6"	7'-6"	6'-6"	6'-6"	6'-6"
	ProSTUD 20* 400PDS125-18	0.0190	70	12	16'-3"	15'-6"	13'-7"	13'-3"	13'-3"	11'-10"	11'-6"	11'-6"	10'-9"
		0.0190	70	16	14'-1"	14'-1"	12'-4"	11'-6"	11'-6"	10'-9"	9'-11"	9'-11"	9'-9"
		0.0190	70	24	11'-6"	11'-6"	10'-9"	9'-4"	9'-4"	9'-4"	8'-1"	8'-1"	8'-1"
	ProSTUD 30MIL 400PDS125-30	0.0312	33	12	21'-1"	18'-8"	16'-4"	17'-2"	16'-4"	14'-3"	14'-11"	14'-10"	13'-0"
		0.0312	33	16	18'-3"	17'-0"	14'-10"	14'-11"	14'-10"	13'-0"	12'-11"	12'-11"	11'-9"
		0.0312	33	24	14'-11"	14'-10"	13'-0"	12'-2"	12'-2"	11'-4"	10'-6"	10'-6"	10'-3"
	ProSTUD 33MIL 400PDS125-33	0.0346	33	12	22'-5"	19'-4"	16'-11"	18'-4"	16'-11"	14'-9"	15'-10"	15'-4"	13'-5"
		0.0346	33	16	19'-5"	17'-7"	15'-4"	15'-10"	15'-4"	13'-5"	13'-9"	13'-9"	12'-2"
		0.0346	33	24	15'-10"	15'-4"	13'-5"	13'-0"	13'-0"	11'-9"	11'-3"	11'-3"	10'-8"
6	ProSTUD 25* 600PDS125-15	0.0158	50	12	15'-11"	15'-11"	15'-11"	13'-0"	13'-0"	13'-0"	11'-3"	11'-3"	11'-3"
		0.0158	50	16	13'-9"	13'-9"	13'-9"	11'-3"	11'-3"	11'-3"	8'-11"	8'-11"	8'-11"
		0.0158	50	24	11'-3"	11'-3"	11'-3"	7'-11"	7'-11"	7'-11"	6'-0"	6'-0"	6'-0"
	ProSTUD 20* 600PDS125-18	0.0190	70	12	20'-10"	20'-8"	18'-0"	17'-0"	17'-0"	15'-9"	14'-8"	14'-8"	14'-4"
		0.0190	70	16	18'-0"	18'-0"	16'-4"	14'-8"	14'-8"	14'-4"	12'-9"	12'-9"	12'-9"
		0.0190	70	24	14'-8"	14'-8"	14'-4"	12'-0"	12'-0"	12'-0"	10'-5"	10'-5"	10'-5"
	ProSTUD 30MIL 600PDS125-30	0.0312	33	12	26'-9"	25'-7"	22'-4"	21'-10"	21'-10"	19'-7"	18'-11"	18'-11"	17'-9"
		0.0312	33	16	23'-2"	23'-2"	20'-4"	18'-11"	18'-11"	17'-9"	16'-5"	16'-5"	16'-2"
		0.0312	33	24	18'-11"	18'-11"	17'-9"	15'-5"	15'-5"	15'-5"	13'-5"	13'-5"	13'-5"
	ProSTUD 33MIL 600PDS125-33	0.0346	33	12	28'-4"	26'-7"	23'-2"	23'-2"	23'-2"	20'-3"	20'-1"	20'-1"	18'-5"
		0.0346	33	16	24'-7"	24'-1"	21'-1"	20'-1"	20'-1"	18'-5"	17'-5"	17'-5"	16'-9"
		0.0346	33	24	20'-1"	20'-1"	18'-5"	16'-5"	16'-5"	16'-1"	14'-2"	14'-2"	14'-2"

Notes:

- Calculated properties are based on AISI S100-16 (2020) w/S2-20 North American Specification for Design of Cold-Formed Steel Structural Members and AISI S220-20 North American Standard for Cold-Formed Steel Framing—Nonstructural Members, using steel properties alone.
- Above moment capacities are based on discrete stud bracing at 4 ft. o.c.
- Heights are limited by moment, deflection, shear, and web crippling (assuming 1" end reaction bearing).
- * Web stiffeners are required at bearing points.

Complies with IBC 2024 • AISI S100 • AISI S220

ProSTUD® 3-5/8" Sound Assemblies

Partition type	Assembly description		STC Rating / Test Report			
			ProSTUD 25 (15mil)	ProSTUD 20 (18mil)	ProSTUD 30mil	ProSTUD 33mil
	3-5/8" ProSTUD 1 layer 5/8" Type X GWB on each side	@ 24" o.c.	43 TL09-539	40 TL19-091	37 TL20-412	36 TL13-197
	3-5/8" ProSTUD 3-1/2" R-13 unfaced insulation 1 layer 5/8" Type X GWB on each side	@ 24" o.c.	48 TL09-540	47 TL19-094	40 TL20-413	37 TL13-196
	3-5/8" ProSTUD 3-1/2" R-13 unfaced insulation 1 layer 5/8" Type X GWB on one side 2 layers 5/8" Type X GWB on the other side	@ 24" o.c.	49 TL13-167	51 TL19-092	40 TL13-202	42 TL13-195
	3-5/8" ProSTUD 3-1/2" R-13 unfaced insulation 2 layers 5/8" Type X GWB on each side	@ 24" o.c.	54 TL09-538	52 TL19-093	42 TL13-201	45 TL13-194
	3-5/8" ProSTUD 3-1/2" R-13 unfaced insulation RC-Deluxe w/ 1 layer 5/8" Type X GWB on one side 1 layer 5/8" Type X GWB on the other side	@ 24" o.c.	54 TL18-302	53 TL19-097	48 TL20-414	50 TL16-369
	3-5/8" ProSTUD 3-1/2" R-13 unfaced insulation RC-Deluxe w/ 2 layers 5/8" Type X GWB on one side 1 layer 5/8" Type X GWB on the other side	@ 24" o.c.	59 TL09-543	58 TL19-096	55 TL20-415	56 TL16-370
	3-5/8" ProSTUD 3-1/2" R-13 unfaced insulation RC-Deluxe w/ 2 layers 5/8" Type X GWB on one side 2 layers 5/8" Type X GWB on the other side	@ 24" o.c.	62 TL13-181	60 TL19-095	58 TL20-416	58 TL13-200

Notes:

- Sound assemblies are certified by Western Electro-Acoustic Laboratories.
- NVLAP accredited for ASTM E90 & E413, ISO Certified.
- See STC test reports at www.clarkdietrich.com/ProSTUD for detailed requirements of construction of wall assembly. Contact ClarkDietrich Technical Services at 888-437-3244 for questions about ProSTUD sound assemblies.

For Resilient Channel Installation Guidelines
see: www.clarkdietrich.com/RC

Visit itools.clarkdietrich.com for a complete list of sound ratings.

Complies with IBC 2024 • AISI S100 • AISI S220

ProSTUD 1-5/8" Stud Chase Sound Assemblies					Two parallel rows		
Gypsum type	Side A	Side B	Insulation type	Stud spacing	STC Rating	Test report	Partition type
					ProSTUD 25 (15mil)		
5/8" Type X	1 layer	1 layer	R-13* unfaced	24"	55	TL09-590	1 Similar
5/8" Type X	1 layer	2 layers	R-13* unfaced	24"	59	TL09-591	1 Similar
5/8" Type X	2 layers	2 layers	R-13* unfaced	24"	61	TL09-592	1

ProSTUD 2-1/2" Stud Chase Sound Assemblies					Staggered in opposite walls		
Gypsum type	Side A	Side B	Insulation type	Stud spacing	STC Rating	Test report	Partition type
					ProSTUD 25 (15mil)		
5/8" Type X	1 layer	1 layer	R-13* unfaced*	24"	58	TL09-593	2 Similar
5/8" Type X	1 layer	2 layers	R-13* unfaced*	24"	63	TL09-594	2 Similar
5/8" Type X	2 layers	2 layers	R-13* unfaced*	24"	65	TL09-595	2

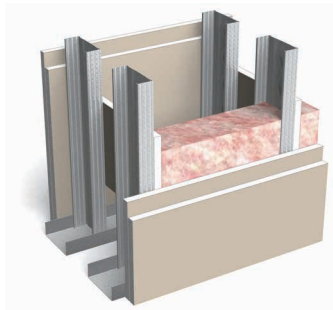

Partition Type 1

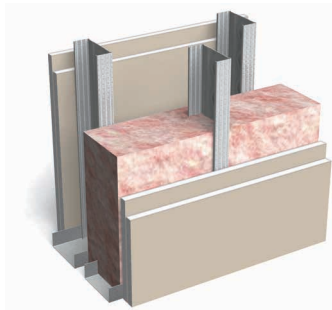

Partition Type 2

Notes:

- Sound Assemblies are certified by Western Electro-Acoustic Laboratories.
 - NVLAP Accredited for ASTM E90 & E413, ISO Certified.
 - See STC test reports at www.clarkdietrich.com/ProSTUD for detailed requirements of construction of wall assembly.
- * Values are the same for R-11 insulation.
 Contact ClarkDietrich Technical Services at 888-437-3244 for questions about ProSTUD sound assemblies.

ProSTUD® Single Stud Wall—Fire Assemblies^A

UL design no.	Hourly rating	ProSTUD minimum thickness	ProSTUD minimum depth	UL design no.	Hourly rating	ProSTUD minimum thickness	ProSTUD minimum depth
U403	2	ProSTUD 20 (18mil)	3-5/8"	V410	2	ProSTUD 20 (18mil)	1-5/8"
U407	1/2 or 1	ProSTUD 25 (15mil)	3-5/8"	V412	2	ProSTUD 20 (18mil)	3-5/8"
U408	2	ProSTUD 20 (18mil)	3-5/8"	V416	1	ProSTUD 20 (18mil)	3-5/8"
U411	2	ProSTUD 25 (15mil)	2-1/2"	V417	1	ProSTUD 20 (18mil)	3-5/8"
U412	2	ProSTUD 25 (15mil)	1-5/8"	V418	2	ProSTUD 20 (18mil)	1-5/8"
U419	1, 2, 3 or 4	ProSTUD 25 (15mil)	(See Table 1 below)	V419	2	ProSTUD 20 (18mil)	2-1/2"
U421	2	ProSTUD 25 (15mil)	3-5/8"	V425	1	ProSTUD 20 (18mil)	2-1/2"
U431	4	ProSTUD 20 (18mil)	3-5/8"	V435	1	ProSTUD 20 (18mil)	3-5/8"
U435	3 or 4	ProSTUD 25 (15mil)	1-5/8"	V438	1, 2, 3 or 4	ProSTUD 25 (15mil)	(See Table 1 below)
U442*	1	ProSTUD 33MIL	2-1/2"	V443	4	ProSTUD 20 (18mil)	3-5/8"
U450	1 or 3	ProSTUD 20 (18mil)	3-5/8"	V444	1	ProSTUD 20 (18mil)	3-5/8"
U451	1	ProSTUD 20 (18mil)	2-1/2"	V448	1	ProSTUD 20 (18mil)	3-5/8"
U454	2	ProSTUD 20 (18mil)	2-1/2"	V449	2	ProSTUD 20 (18mil)	3-5/8"
U463	3 or 4	ProSTUD 20 (18mil)	1-5/8"	V450	1	ProSTUD 25 (15mil)	3-5/8"
U465	1	ProSTUD 20 (18mil)	3-5/8"	V450	2	ProSTUD 25 (15mil)	2-1/2"
U471	1-1/2	ProSTUD 20 (18mil)	3-5/8"	V452	1 or 2	ProSTUD 20 (18mil)	3-5/8"
U475	1, 2 or 3	ProSTUD 20 (18mil)	3-5/8"	V453*	1-1/2	ProSTUD 33MIL	6"
U478	3	ProSTUD 20 (18mil)	1-5/8"	V461*	1	ProSTUD 33MIL	3-5/8"
U484*	2	ProSTUD 33MIL	2-1/2"	V476	1 or 3	ProSTUD 20 (18mil)	3-5/8"
U488*	1	ProSTUD 33MIL	2-1/2"	V477	1, 2, 3 or 4	ProSTUD 25 (15mil)	(See Table 1 below)
U490	4	ProSTUD 20 (18mil)	2-1/2"	V487	2	ProSTUD 20 (18mil)	1-5/8"
U491	2	ProSTUD 20 (18mil)	3-5/8"	V489	1, 2, 3 or 4	ProSTUD 25 (15mil)	(See Table 1 below)
U494	1	ProSTUD 20 (18mil)	2-1/2"	V498	1, 2, 3 or 4	ProSTUD 25 (15mil)	(See Table 1 below)
U495	1 or 2	ProSTUD 20 (18mil)	3-5/8"	W411	1/2 or 1	ProSTUD 25 (15mil)	3-5/8"
U496	1	ProSTUD 20 (18mil)	1-5/8"	W415	1 or 2	ProSTUD 20 (18mil)	2-1/2"
				W424	1	ProSTUD 25 (15mil)	3-5/8"

ProSTUD Chase or Double Stud—Fire Assemblies^A

UL design no.	Hourly rating	ProSTUD minimum thickness	ProSTUD minimum depth	UL design no.	Hourly rating	ProSTUD minimum thickness	ProSTUD minimum depth
U420	2	ProSTUD 25 (15mil)	1-5/8"	V442	2	ProSTUD 25 (15mil)	1-5/8"
U436	1, 2, or 3	ProSTUD 20 (18mil)	1-5/8"	V464	1	ProSTUD 25 (15mil)	3-5/8"
U444	2	ProSTUD 25 (15mil)	1-5/8"	V469*	1	ProSTUD 33 (33mil)	2-1/2"
U445*	1	ProSTUD 33 (33mil)	1-5/8"	V469	2	ProSTUD 20 (18mil)	2-1/2"
U466	1	ProSTUD 20 (18mil)	2-1/2"	V488	1 or 2	ProSTUD 20 (18mil)	2-1/2"
U493	2	ProSTUD 25 (15mil)	2-1/2"	V490*	1 or 2	ProSTUD 33 (33mil)	2-1/2"
V437	1	ProSTUD 20 (18mil)	1-5/8"	V496	1 or 2	ProSTUD 20 (18mil)	2-1/2"

ProSTUD Table 1: Minimum Depth of ProSTUD Required^A

Hourly rating	Min. stud depth (in)	No. of layers and thickness of gypsum board	UL U419	UL V438	UL V477	UL V489	UL V498
1	2-1/2"	1 layer, 1/2"	—	—	—	✓	—
1	3-5/8"	1 layer, 5/8"	✓	✓	✓	✓	✓
2	1-5/8"	2 layer, 1/2"	✓	✓	✓	✓	✓
2	1-5/8"	2 layer, 5/8"	✓	—	✓	✓	✓
2	2-1/2"	2 layer, 5/8"	—	✓	—	—	—
3	1-5/8"	3 layer, 1/2"	✓	✓	✓	✓	✓
3	1-5/8"	3 layer, 5/8"	✓	✓	✓	✓	✓
4	1-5/8"	4 layer, 1/2"	✓	✓	✓	✓	✓
4	1-5/8"	4 layer, 5/8"	✓	✓	✓	✓	✓

Notes:

^ASee UL listing for detailed requirements of construction of tested assembly.

*ProSTUD meets or exceeds the description of the generic stud/track listed in the UL assembly.



Deep Leg Deflection Track Systems

Head-of-wall vertical deep leg deflection track systems are required to allow the top of the wall stud to float within the top track legs. This condition allows for vertical live load movement of the primary structure without transferring axial loads to the interior drywall studs. A gap (determined by the Engineer of Record) is required between the top of the wall stud and the deflection track.

- Wall framing with Deflection Track is a non-composite design since the screws attaching the gypsum board are not directly attached to the top track. **(NEW) information on Head-of-Wall Composite systems using deflection track can be found on page 10.**

ProSTUD® Drywall Framing studs can be used with the three Deep Leg Track Systems listed below:

ProTRAK® Deep Leg Track

ProTRAK deep leg track is available with leg lengths of 2", 2-1/2" and 3" long. The wall studs are not fastened to the deflection track, and a row of lateral bracing is required within 12" of the deep leg track to prevent rotation and lateral movement of the studs. The deflection track system must be designed for the end reaction of the wall studs (point loads) and for the specific gap required for vertical deflection.

ProTRAK® Allowable Lateral Loads and Wall Heights

Deflection track system	2" Leg Track with 1/2" Gap		2-1/2" Leg Track with 3/4" Gap		3" Leg Track with 1" Gap	
	Allowable load (lbs)	Limiting wall height	Allowable load (lbs)	Limiting wall height	Allowable load (lbs)	Limiting wall height
ProTRAK 25	36	10'-8"	24	7'-2"	18	5'-4"
ProTRAK 20	52	15'-6"	34	10'-4"	26	7'-9"
ProTRAK 30MIL	92	27'-6"	61	18'-4"	46	13'-9"
ProTRAK 33MIL	113	33'-10"	75	22'-7"	56	16'-11"

Notes:

- Limiting wall heights are based on studs spaced at 16" o.c. and an interior lateral load of 5psf.
- Stud members must be analyzed independently of the track system. Use www.iProSTUD.com to check limiting wall heights for ProSTUD members.
- Stud failure modes relating to the deflection track connection (shear, web crippling, etc.) must be checked separately.

Structural Deep Leg Track (18ga & 16ga)

Structural Deep Leg Track systems are installed the same as the ProTRAK deep leg track system but are designed to handle tall wall systems.

For structural deep leg track allowable loads, contact Technical Services at 888-437-3244 or visit clarkdietrich.com.

Slotted Deflection Track from ClarkDietrich

The slotted deflection track is attached to the wall studs through vertical slots using wafer head screws, creating a positive connection that allows for vertical movement and also eliminates the requirement for lateral bracing near the top of the wall stud.

MaxTrak® Allowable Lateral Loads and Wall Heights

Deflection track system	ProSTUD 25 (15mil, 50ksi)		ProSTUD 20 (18mil, 70ksi)		ProSTUD 30mil (33ksi)		ProSTUD 33mil (33ksi)	
	Allowable load (lbs)	Limiting wall height	Allowable load (lbs)	Limiting wall height	Allowable load (lbs)	Limiting wall height	Allowable load (lbs)	Limiting wall height
MaxTrak 30MIL	45	13'-6"	76	22'-10"	148	44'-4"	148	44'-4"
MaxTrak 33MIL	52	15'-7"	88	26'-5"	156	46'-10"	156	46'-10"

Notes:

- Allowable loads are based on screws through the slots located 1-1/4" from the track web.
- #8 minimum wafer head screws shall be used for stud-track connection.
- The above table is applicable to ProSTUD members only. ProSTUD allowable heights must be checked also.
- Allowable heights are based on 5psf and wall stud spacing at 16" o.c. with a max. gap of 7/8"

Complete information on Allowable Loads is available at clarkdietrich.com.

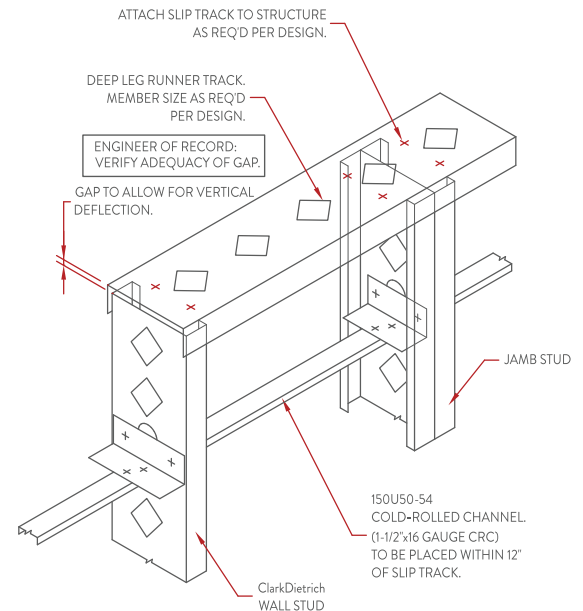

1 DEEP LEG DEFLECTION TRACK DETAIL WITH LATERAL BRACING WITHIN 12" OF SLIP TRACK

Details shown are for example only. The engineer of record of the project is responsible for the design of the connection to the structure. Additional connection details can be found at clarkdietrich.com.

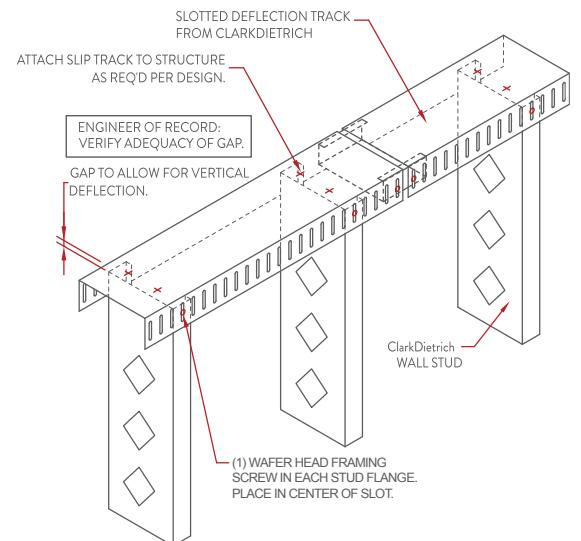

2 SLOTTED DEFLECTION TRACK DETAIL WITH TRACK SPLICE

ClarkDietrich offers both the MaxTrak® Slotted Deflection Track and BlazeFrame® Integrated Fire Stop System. Find more information on these systems at clarkdietrich.com.

ProSTUD® Allowable Ceiling Spans

Deflection Limit L/240

Section	F _y (ksi)	4psf Lateral Support of Compression Flange						6psf Lateral Support of Compression Flange					
		Unsupported joist spacing (in) o.c.			Mid-span joist spacing (in) o.c.			Unsupported joist spacing (in) o.c.			Mid-span joist spacing (in) o.c.		
		12	16	24	12	16	24	12	16	24	12	16	24
162PDS125-15	50	7'-3"	6'-8"	5'-11"	7'-10"	7'-2"	6'-3"	6'-5"	5'-11"	5'-3"	6'-10"	6'-3"	5'-5"
250PDS125-15	50	8'-4"	7'-8"	6'-11"	10'-11"	9'-11"	8'-8"	7'-5"	6'-11"	6'-2"	9'-7"	8'-8"	7'-7"
362PDS125-15	50	9'-2"	8'-6"	7'-7"	12'-9"	11'-8"	10'-3"	8'-3"	7'-7"	6'-9"	11'-3"	10'-3"	8'-11" e
400PDS125-15	50	9'-5"	8'-9"	7'-10"	13'-1"	12'-0"	10'-7" e	8'-6"	7'-10"	6'-11" e	11'-7" e	10'-7" e	9'-3" e
600PDS125-15	50	10'-8"	9'-10"	8'-10"	15'-0"	13'-9"	12'-2"	9'-6"	8'-10"	7'-11"	13'-3"	12'-2"	9'-11" e
162PDS125-18	70	7'-10"	7'-3"	6'-6"	8'-4"	7'-7"	6'-8"	7'-1"	6'-6"	5'-9"	7'-4"	6'-8"	5'-10"
250PDS125-18	70	9'-0"	8'-5"	7'-7"	11'-9"	10'-8"	9'-4"	8'-2"	7'-7"	6'-9"	10'-3"	9'-4"	8'-2"
362PDS125-18	70	9'-11"	9'-2"	8'-3"	14'-1"	12'-11"	11'-6"	8'-11"	8'-3"	7'-5"	12'-6"	11'-6"	10'-2"
400PDS125-18	70	10'-2"	9'-5"	8'-6"	14'-6"	13'-4"	11'-10"	9'-2"	8'-6"	7'-8"	12'-11"	11'-10"	10'-6"
600PDS125-18	70	11'-10"	10'-11"	9'-10"	16'-10"	15'-6"	13'-10"	10'-7"	9'-10"	8'-10"	15'-0"	13'-10"	12'-3"
162PDS125-30	33	9'-4"	8'-7"	7'-8"	9'-10"	9'-0"	7'-10"	8'-3"	7'-8"	6'-10"	8'-7"	7'-10"	6'-10"
250PDS125-30	33	10'-4"	9'-7"	8'-6"	13'-8"	12'-5"	10'-10"	9'-3"	8'-6"	7'-8"	11'-11"	10'-10"	9'-6"
362PDS125-30	33	11'-3"	10'-5"	9'-4"	16'-2"	15'-0"	13'-6"	10'-1"	9'-4"	8'-5"	14'-7"	13'-6"	12'-0"
400PDS125-30	33	11'-7"	10'-9"	9'-8"	16'-8"	15'-6"	13'-11"	10'-5"	9'-8"	8'-8"	15'-0"	13'-11"	12'-5"
600PDS125-30	33	13'-1"	12'-2"	10'-11"	18'-11"	17'-6"	15'-8"	11'-9"	10'-11"	9'-10"	17'-0"	15'-8"	14'-1"
162PDS125-33	33	9'-9"	9'-0"	8'-0"	10'-4"	9'-4"	8'-2"	8'-8"	8'-0"	7'-1"	9'-0"	8'-2"	7'-2"
250PDS125-33	33	10'-9"	9'-11"	8'-10"	14'-3"	12'-11"	11'-3"	9'-7"	8'-10"	7'-11"	12'-5"	11'-3"	9'-10"
362PDS125-33	33	11'-8"	10'-9"	9'-8"	16'-8"	15'-5"	13'-11"	10'-5"	9'-8"	8'-8"	15'-0"	13'-11"	12'-6"
400PDS125-33	33	12'-0"	11'-1"	9'-11"	17'-2"	15'-11"	14'-4"	10'-9"	9'-11"	8'-11"	15'-5"	14'-4"	12'-10"
600PDS125-33	33	13'-6"	12'-6"	11'-3"	19'-6"	18'-1"	16'-3"	12'-2"	11'-3"	10'-1"	17'-6"	16'-3"	14'-7"

ProSTUD Allowable Ceiling Spans

Deflection Limit L/360

Section	F _y (ksi)	4psf Lateral Support of Compression Flange						6psf Lateral Support of Compression Flange					
		Unsupported joist spacing (in) o.c.			Mid-span joist spacing (in) o.c.			Unsupported joist spacing (in) o.c.			Mid-span joist spacing (in) o.c.		
		12	16	24	12	16	24	12	16	24	12	16	24
162PDS125-15	50	6'-10"	6'-3"	5'-5"	6'-10"	6'-3"	5'-5"	6'-0"	5'-5"	4'-9"	6'-0"	5'-5"	4'-9"
250PDS125-15	50	8'-4"	7'-8"	6'-11"	9'-7"	8'-8"	7'-7"	7'-5"	6'-11"	6'-2"	8'-4"	7'-7"	6'-8"
362PDS125-15	50	9'-2"	8'-6"	7'-7"	12'-9"	11'-7"	10'-1"	8'-3"	7'-7"	6'-9"	11'-2"	10'-1"	8'-10" e
400PDS125-15	50	9'-5"	8'-9"	7'-10"	13'-1"	12'-0"	10'-7" e	8'-6"	7'-10"	6'-11" e	11'-7" e	10'-7" e	9'-3" e
600PDS125-15	50	10'-8"	9'-10"	8'-10"	15'-0"	13'-9"	12'-2"	9'-6"	8'-10"	7'-11"	13'-3"	12'-2"	9'-11" e
162PDS125-18	70	7'-4"	6'-8"	5'-10"	7'-4"	6'-8"	5'-10"	6'-5"	5'-10"	5'-1"	6'-5"	5'-10"	5'-1"
250PDS125-18	70	9'-0"	8'-5"	7'-7"	10'-3"	9'-4"	8'-2"	8'-2"	7'-7"	6'-9"	9'-0"	8'-2"	7'-2"
362PDS125-18	70	9'-11"	9'-2"	8'-3"	13'-9"	12'-6"	10'-11"	8'-11"	8'-3"	7'-5"	12'-0"	10'-11"	9'-6"
400PDS125-18	70	10'-2"	9'-5"	8'-6"	14'-6"	13'-4"	11'-8"	9'-2"	8'-6"	7'-8"	12'-10"	11'-8"	10'-2"
600PDS125-18	70	11'-10"	10'-11"	9'-10"	16'-10"	15'-6"	13'-10"	10'-7"	9'-10"	8'-10"	15'-0"	13'-10"	12'-3"
162PDS125-30	33	8'-7"	7'-10"	6'-10"	8'-7"	7'-10"	6'-10"	7'-6"	6'-10"	6'-0"	7'-6"	6'-10"	6'-0"
250PDS125-30	33	10'-4"	9'-7"	8'-6"	11'-11"	10'-10"	9'-6"	9'-3"	8'-6"	7'-8"	10'-5"	9'-6"	8'-3"
362PDS125-30	33	11'-3"	10'-5"	9'-4"	15'-11"	14'-6"	12'-8"	10'-1"	9'-4"	8'-5"	13'-11"	12'-8"	11'-1"
400PDS125-30	33	11'-7"	10'-9"	9'-8"	16'-8"	15'-6"	13'-9"	10'-5"	9'-8"	8'-8"	15'-0"	13'-9"	12'-0"
600PDS125-30	33	13'-1"	12'-2"	10'-11"	18'-11"	17'-6"	15'-8"	11'-9"	10'-11"	9'-10"	17'-0"	15'-8"	14'-1"
162PDS125-33	33	9'-0"	8'-2"	7'-2"	9'-0"	8'-2"	7'-2"	7'-10"	7'-2"	6'-3"	7'-10"	7'-2"	6'-3"
250PDS125-33	33	10'-9"	9'-11"	8'-10"	12'-5"	11'-3"	9'-10"	9'-7"	8'-10"	7'-11"	10'-10"	9'-10"	8'-7"
362PDS125-33	33	11'-8"	10'-9"	9'-8"	16'-6"	15'-0"	13'-2"	10'-5"	9'-8"	8'-8"	14'-5"	13'-2"	11'-6"
400PDS125-33	33	12'-0"	11'-1"	9'-11"	17'-2"	15'-11"	14'-3"	10'-9"	9'-11"	8'-11"	15'-5"	14'-3"	12'-5"
600PDS125-33	33	13'-6"	12'-6"	11'-3"	19'-6"	18'-1"	16'-3"	12'-2"	11'-3"	10'-1"	17'-6"	16'-3"	14'-7"

Notes:

- For unbraced sections, allowable moment is based on AISI S100-16 (2020) w/S2-20 Specification Section F2 & F3 with weak axis and torsional unbraced length assumed to be the listed span (completely unbraced). For mid-span braced sections, allowable moment based on Section F2 & F3 with weak axis and torsional unbraced length assumed to be one-half of the listed span (bracing at mid-span).
- Web crippling calculation based on bearing length = 1 inch.
- Web crippling and shear capacity have not been reduced for punchouts. If web punchouts occur near support members must be checked for reduced shear and web crippling in accordance with the AISI S100 Specification.
- Values are for simple span conditions.
- e Web stiffeners required at support.

Complies with IBC 2024 • AISI S100 • AISI S220

Allowable Screw Design Values (lbs)

Member designation	Thickness (mils)	Design thickness (in)	Yield (ksi)	Ultimate	#6 Screw (0.138" Dia., 5/16" Head)				#8 Screw (0.164" Dia., 5/16" Head)				#10 Screw (0.190" Dia., 0.34" Head)			
					Shear, lbs	1-Side	2-Side	Pullout, lbs	Shear, lbs	1-Side	2-Side	Pullout, lbs	Shear, lbs	1-Side	2-Side	Pullout, lbs
PDS125-15	15	0.0158	50	50	52	62	123	31	56	62	123	37	61	67	134	43
PDS125-18	18	0.0190	70	70	95	104	208	52	104	104	208	62	112	113	226	72
PDS125-19	19	0.0200	65	65	96	102	203	51	104	102	203	60	112	111	221	70
PDS125-30	30	0.0312	33	33	95	80	161	40	103	80	161	48	111	88	175	55
PDS125-33	33	0.0346	33	45	151	122	243	61	164	122	243	72	177	132	265	84

Notes:

- Allowable screw connection capacities are based on Section J4 of the AISI S100-16 (2020) w/S2-20 Specification.
- When connecting materials of different steel thicknesses or tensile strengths, use the lowest values. Tabulated values assume two sheets of equal thickness are connected.
- Screw shear and tension capacities were developed using published screw manufacturer data and evaluation reports available at the time of publication.
- Screw capacities are based on Allowable Strength Design (ASD) and include a safety factor of 3.0.
- When multiple fasteners are used, screws are assumed to have a center-to-center spacing of at least three times the nominal diameter (d).
- Screws are assumed to have a center-of-screw to edge-of-steel dimension of at least 1-1/2 times the nominal diameter (d) of the screw.
- Tension capacity is based on the lesser of pullout capacity in sheet closest to screw tip, or pullover capacity for sheet closest to screw head (using head diameter).
- Screw capacities are governed by a conservative estimate of screw capacity, not by sheet steel failure.
- For higher screw capacities, especially for screw strength, use specific screws from specific manufacturer. See manufacturer's data for specific allowable values and installation instructions.

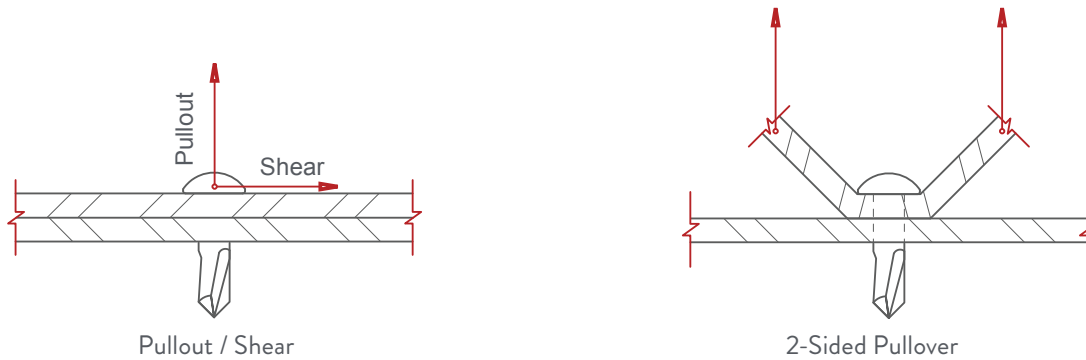

Collaborative Services

CLARKDIETRICH ENGINEERING SERVICES

Smarter engineering and technical expertise. It's support that extends beyond the structure itself.

From the initial design phase to jobsite installation, we are all about providing inventive, yet practical and hands-on know-how to help you think outside the box—or to help you just get it done.

ClarkDietrich Engineering Services is a full-service consulting firm that believes strongly in value engineering and customer input. Our engineering fees and lead times are competitive, and our customer service exceeds the industry standard with consistent point-of-contact through our regional project managers.

We offer Building Information Modeling (BIM) services that include specialty engineering collaborative design. We support the BIM movement by offering add-on tools that allow our products, and the rich data attached to them, to quickly be imported into digital designs. Our team is also comprised of LEED® Accredited professionals to consult on sustainable building design.

- Electronically sealed shop drawings and calculations
- Preliminary sizing and pre-bid engineering pricing
- Reference plan on large projects
- Detailed wall sections, full elevation opening design and C-stud truss design

Our technical services team provides immediate response to questions ranging from general installation to detailed specification requirements, and can deliver one-day turnaround on technical sizing. We are experts on industry standards such as AISI and ASTM, and a proud member of SFIA. Our team also supports our online product submittal system, SubmittalPro®, and our design/engineering software is available as a free download from www.clarkdietrich.com.

- Product support and typical member sizing
- Framing detail recommendations
- Compliance and industry standards, such as AISI, ASTM and SFIA
- Engineering software and product submittal support
- LEED requirements support

CLIP EXPRESSSM

Connections you can count on.

We know that having the right products, at the right time, and at the right price, is absolutely essential to getting the job done. ClarkDietrich Clip Express is your single source for the widest and most cost-effective array of rigid, deflection, bridging and general-purpose clips, connectors, supports and framing hardware for commercial and residential cold-formed steel framing.

With Clip Express, you get fully engineered, rigorously tested and precision-formed connectors each and every time. Many of our connectors were developed by, or in conjunction with, framing installers in order to deliver high-performance products for significant installed savings.

While you may find a cheaper price than ClarkDietrich, you won't find a lower overall cost or better value. We offer unmatched reach through numerous plants and engineering offices—and nationwide product availability.

And because staying on schedule is crucial, we ship most orders the same day they are received. We'll get it there when, how and where you need it. Our nationwide manufacturing and service facilities see to that.

- Industry's widest product selection available from one source
- Fast delivery options meet your deadlines
- Backed by the largest cold-formed steel framing and engineering company in the world
- Expert field representatives for comprehensive product, installation and sales training



ProSTUD® & ProTRAK® CODE APPROVALS AND PERFORMANCE STANDARDS

ClarkDietrich® ProSTUD Drywall Framing System meets or exceeds these applicable performance standards.

ProSTUD® Drywall Framing Standards

AISI S100-16 (2020) w/S2-20 - North American Specification for the Design of Cold-Formed Steel Structural Members

AISI S220-20 - North American Standard for Cold-Formed Steel Framing Nonstructural Members

Section A3 Material - Chemical & mechanical requirements (Referencing ASTM A1003/A1003M)

Section A4 Corrosion Protection (Referencing ASTM A653/A653M)

Section A5 Products - Thickness, shapes, tolerances, identification

Section C Installation (Referencing ASTM C754)

AISI S202 - Code of Standard Practice for Cold-Formed Steel Structural Framing

Section F3 Delivery, Handling and Storage of Materials

ClarkDietrich Nonstructural Framing comply with:

IBC-2024 - International Building Code

Intertek CCRR-0207

LA RR #26019 - City of Los Angeles ProSTUD Research Report

NYC - OTCR ProSTUD Approval Letter

SFIA (Steel Framing Industry Association) Code Compliance Certification Program

UL 263 "Fire Tests of Building Construction and Materials"

ASTM E119 - Standard Test Methods for Fire Tests of Building Construction and Materials

ASTM E72 - Standard Test Methods of Conducting Strength Tests of Panels for Building Construction

ASTM E90 - Standard Test Method for Laboratory Measurement of Airborne Sound Transmission Loss of Building Partitions and Elements

Multiple UL® design listings for ProSTUD:

Over 50 UL Designs. See UL file number R26512 for additional information.

UL® and UL® Deisgn are service marks of Underwriters Laboratories, Inc.

U.S. Patent No. 9,010,070

LEED® Services

BUILD GREEN with ClarkDietrich

ClarkDietrich is an active member of the U.S. Green Building Council and is committed to supplying quality products that are environmentally responsible. We are continually working to develop greener building products and sustainable business practices. ClarkDietrich steel framing helps contribute points toward LEED® certification. For more details contact Technical Services at 888-437-3244 or visit www.clarkdietrich.com/LEED.

ClarkDietrich has prepared this literature with the utmost diligence and care for accuracy and conformance to standards.

ClarkDietrich intends this information to be accurate, informative, and helpful as a selection guide for choosing ClarkDietrich products. However, this information is only to be used for guidance and is not intended to replace the design, drawings, specifications, and decisions of a professional architect or engineer.

ClarkDietrich or its affiliates shall not be responsible for incidental or consequential damages, directly or indirectly sustained, nor for loss caused by application of our products for other than their intended uses. Our liability is limited to replacement of defective products. Claims shall be deemed waived unless they are made to us in writing within thirty (30) days of the date a problem was or reasonably should have been discovered.

ClarkDietrich reserves the right to modify or change any information contained in this literature without notification.

ClarkDietrich is a proud member of the Steel Framing Industry Association (SFIA). Check the updated list of Certified Production Facilities at Intertek's website at www.intertek.com. Additional code approvals SFIA (Steel Framing Industry Association) Intertek CCRR0207.



USGBC and related logo is a trademark owned by the U.S. Green Building Council and is used by permission.



For the most up to date version of all ClarkDietrich literature, scan the QR code.

LOCATIONS

ClarkDietrich Manufacturing and Sales Locations:

CALIFORNIA Riverside
P 951.360.3500

CALIFORNIA Sacramento
P 951.360.3500

CONNECTICUT Bristol
P 866.921.0023

FLORIDA Dade City
P 352.518.4400

FLORIDA Miami
P 305.477.6464

GEORGIA McDonough
P 678.304.5500

ILLINOIS Rochelle
P 800.659.0745

MARYLAND Baltimore
P 410.477.4000

MISSOURI O'Fallon
P 636.300.1411

OHIO Warren - East
P 330.372.5564

OHIO Vienna
P 330.372.4014

TEXAS Dallas
P 214.350.1716

TEXAS Pasadena
P 281.383.1617

CLIP EXPRESS™
P 866.638.1908

ClarkDietrich Engineering Services. A full spectrum of solutions.

Toll-Free Phone: 877.832.3206
Toll-Free Fax: 877.832.3208
Technical Services: 888.437.3244
Email: engineering@clarkdietrich.com

CENTRAL Merrillville, IN
NORTHEAST Bristol, CT

SOUTHEAST McDonough, GA
WEST Carlsbad, CA

Turn to ClarkDietrich for a complete lineup of steel construction products and services nationwide:

Interior Framing · Exterior Framing · Interior Finishing · Exterior Finishing · Clips/Connectors · Engineering



ClarkDietrich.

9050 Centre Pointe Dr. Suite 400
West Chester, OH 45069

P 513.870.1100
F 513.870.1300

clarkdietrich.com
Clarkwestern Dietrich Building Systems LLC