



SIERRA PREMIUM SHAKE | SAVANNAH SMOOTH | DECEMBER 2020

Installation Guide

INSTALLATION GUIDE SAVANNAH SMOOTH SIERRA PREMIUM SHAKE

TABLE OF CONTENTS

<i>General</i>	2
Product Inspection	2
Storage & Handling	3
Construction Requirements	3
Technical Design Reviews	3
Minimum Clearances	4
Safety & Cutting	5
Blocked Penetrations	5
Fasteners	5
Finishing & Maintenance	6
<i>Savannah & Sierra Installation</i>	7
Preparation	7
Fastening	7
Starter Strip/First Course	8
Overlap	8
Cut/Shorted Courses	8
Fastening Methods	9
Vertical Joints	10
Staggering Shake Joints & Keyways	10
Trim Joints (Openings, Corners)	11
Outside Corners	12

GENERAL

This guide is intended to enable successful installation of Nichiha's Sierra Premium Shake™ and Savannah Smooth fiber cement siding. Further installation information and technical resources such as instructional videos, Technical Bulletins, three-part specifications, product testing and certifications, and other technical documents are available on our website: nichiha.com/resource-center.

Install products in accordance with the latest installation guidelines and all applicable building codes and other laws, rules, regulations, and ordinances. Review all installation instructions and other applicable product documents before installation. *This install guide's effective date is December 2020.*

PRODUCT INSPECTION

Inspect all products thoroughly prior to installation. Do not install any product which may have been damaged in shipment or displays damage to the primer or finish coats (if applicable).

Contact your local dealer or Nichiha Customer Service Representative toll-free at 1-866-424-4421 immediately should you have any questions about the products.

STORAGE AND HANDLING

Savannah and Sierra boards MUST be stored flat and off the ground prior to installation. Nichiha recommends storing on pallets.

Boards MUST be kept dry and stored in a covered area or covered with a breathable tarp before installation. Moisture saturation before installation may cause shrinkage and board damage. Do not install saturated boards.

All prefinished products are required to be stored in a covered area.

Carry the products on edge. Do not carry or lift boards flat. Improper handling may cause cracking or damage.

Nichiha is not responsible for damage caused by improper storage and handling of products.

CONSTRUCTION REQUIREMENTS

Install Savannah Smooth and Sierra Premium Shake boards over vertical wood framing spaced no greater than 16" (406mm) o.c. with a required APA rated 7/16" (11mm) thickness (minimum) OSB or plywood sheathing.

Structural Insulated Panel (SIP) and structural insulated sheathing (nailbase) applications are acceptable. Refer to **Fastening** on page 7.

When rainscreen furring may be required or desired, minimum 5/4" lumber is recommended for stud walls with wood sheathing and required over masonry (CMU) applications. Align furring vertically, spaced no more than 16" (406mm) o.c.

Boards may be installed on flat, vertical wall applications only. Do not install on sloped or tilted walls or Mansard type roofs.

Lap siding products must be installed horizontally. Do not install in an angled, sloped, or other non-horizontal (chevron, sunburst, diamond) fashion.

A **weather resistive barrier** is *required* in accordance with local building codes. Use an approved weather resistive barrier (WRB) as defined by the 2015 IRC/IBC. The WRB must be installed in accordance with the manufacturer's specifications and local codes if applicable. Nichiha is not liable for water infiltration.

TECHNICAL DESIGN REVIEWS

Please consult with Nichiha Technical Services directly when using Savannah or Sierra on large projects, such as buildings greater than three (3) stories or taller than 45 feet (13.7m), or those located in high-wind regions (Ultimate Design Wind Speed 130 mph or greater). Some special reinforcements may be required.

CLEARANCES & FLASHINGS

Maintain a minimum 1" - 2" (25-51mm) clearance between boards and decking, walks, steps, stoops, porches, and hard surface driveways.

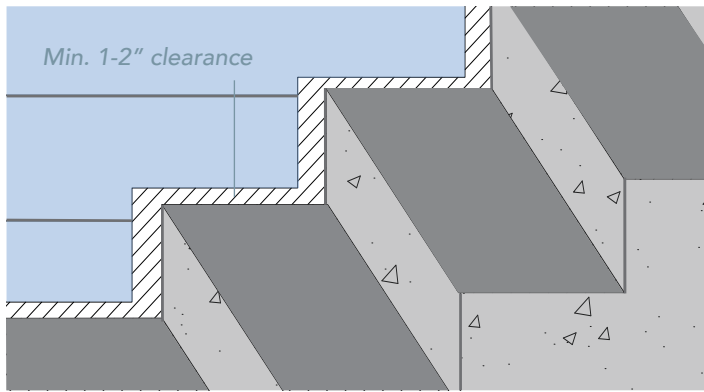

At roof and wall junctures and according to roofing manufacturer's instructions, flashing and counter-flashing are required. Boards must be installed with a minimum 1" (25mm) clearance from roofing.

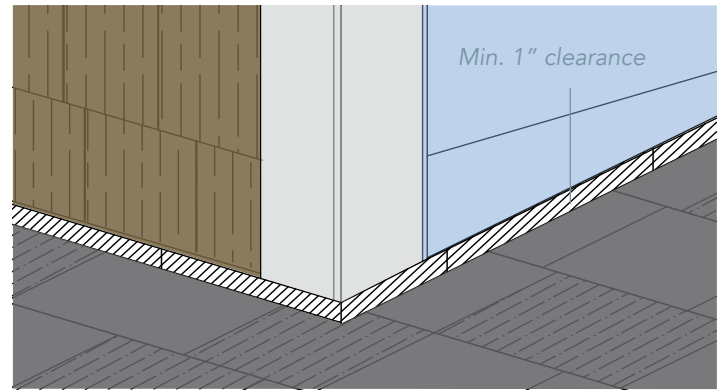

Maintain a minimum clearance of 6" above finished grade, or in accordance with local codes if greater than 6" clearance is required. *National Building Code of Canada requires 200mm min.*

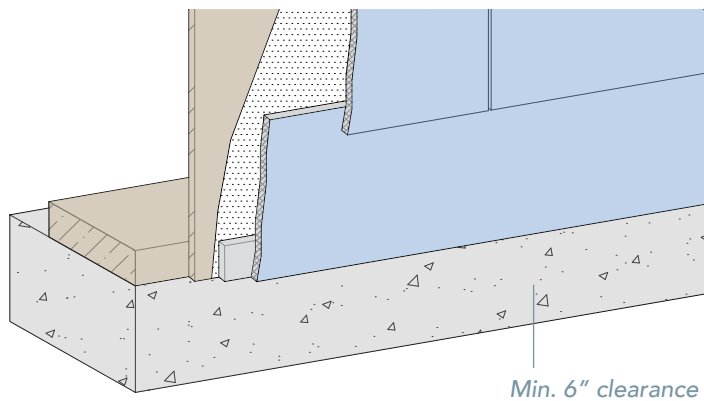

A kickout flashing must be present at roof to wall intersects in order to direct roof water away from the siding and trim.

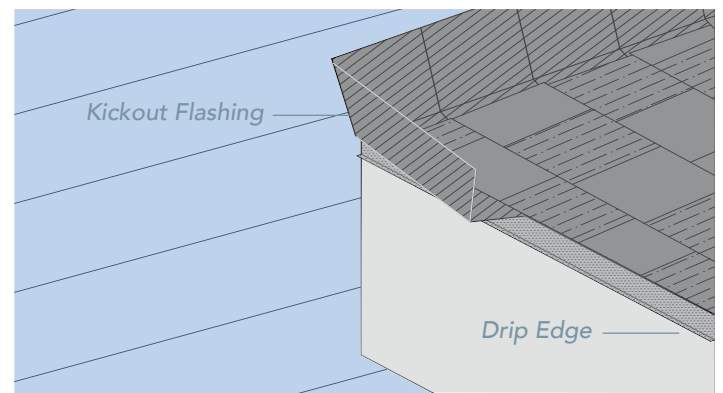

All horizontal trim is required to be flashed with a 1/4" (6mm) clearance between the siding and flashing.

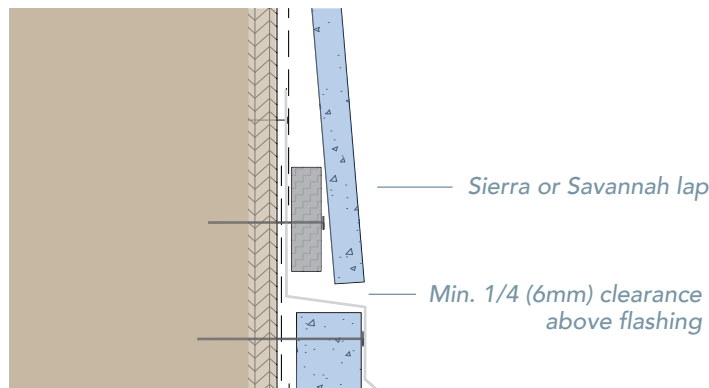

Block out penetrations with flashing over the top edge of the block. Keep a 1/4" (6mm) clearance between the siding and flashing.

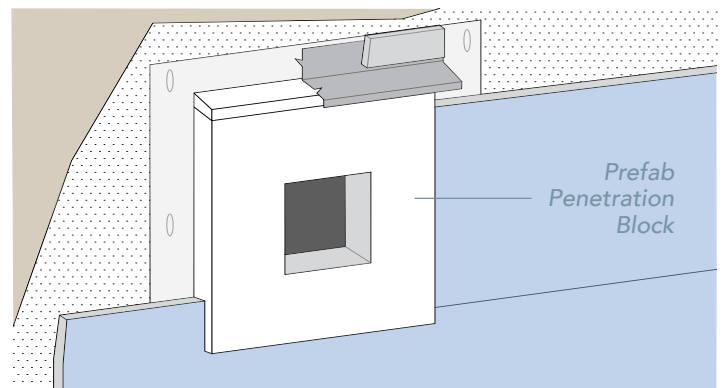

SAFETY & CUTTING¹

As with any natural stone, masonry, or concrete based product, when cutting, drilling, sawing, sanding, or abrading fiber cement cladding, proper safety measures must be taken due to the potential for airborne silica dust, an [OSHA-identified hazardous substance](#) that can pose serious medical risks.

Work outdoors where feasible, otherwise use mechanical ventilation. Position cutting stations so that wind will carry the dust away from the user and others in the work area. Use a dust-reducing or dust collecting circular saw with a vacuum attachment in combination with a diamond-tipped blade designed for cutting fiber cement products. The dust collector must be connected to a HEPA vacuum.

Always wear safety glasses and a NIOSH/OSHA approved respirator with a rating of N100, O100 or P100.

A jig saw fitted with a carbide tipped blade may be used for cutting service opening holes, irregular shapes, radii, and scrollwork.

When using a circular saw, shears, or jigsaw, cut Nichiha products face down. Also ensure the board is fully supported along its length.

Additionally, on factory prefinished products, take steps to protect board finish from damage.

1. See Silica Dust Warning on last page.

BLOCKED PENETRATIONS

All penetrations of 1 ½" (38mm) or larger in diameter must incorporate a blocked and flashed penetration to deter water entry behind the siding. See the detail on page 4 as well as the [Blocked Penetrations Technical Bulletin](#).

FASTENERS - GENERAL

Savannah and Sierra boards may be fastened with appropriate screws or nails, either by hand or with a pneumatic tool. Pneumatic fastening is recommended. *At butt joints, min. #8 screws are required.*

Refer to [Intertek CCRR-0299](#) or [CCMC Report 14307-R](#) for wind load rated assembly and fastener configurations. A design professional should choose the appropriate fastener(s) based on the project's wind design criteria.

Corrosion resistant, full round head siding or roofing nails, or appropriate screws may be used to install boards to wood framing members. Fasteners must penetrate into wood a minimum of 1" (25 mm), except at board ends/butt joints.

When using pneumatic tools, ensure the gun has an adjustable depth of drive or flush mount attachment to control fastener seating depth. The fastener head must be flush to the board surface. Do not over drive or under drive fasteners. Caulk or seal any fasteners that are countersunk more than 1/16" (1.6mm) and add an additional, properly-seated fastener.

DO NOT use framing nailers as board damage may result.

Pressure from compressors can vary depending on tank volume and the number of lines connected to the unit. For best performance, always test and adjust pressure before beginning installation.

Corrosion resistant fasteners, such as hot-dipped galvanized nails and screws appropriate to local building codes and practices must be used. Stainless steel fasteners are highly recommended in high-humidity and high-moisture regions. Nichiha is not liable for corrosion resistance of fasteners. Do not use aluminum fasteners, staples, finish nails, clipped head or T-head nails, or fasteners not rated or designed for intended use.

FINISHING & MAINTENANCE

Use an exterior grade high-quality sealant that complies with either ASTM C-834 (for primed products) or ASTM C-920 (for prefinished products) requirements for all gaps that require filling with sealant. Follow the manufacturer's instructions for use.

All exposed field cut edges (i.e. outside edges, field cut door and window cut outs, field cut butt joints, bottom ends of corners and window trim), must be sealed with a primer or finish paint.

Dents, chips, scratches, etc. on the products should be filled with exterior grade cementitious patching or putty. Follow the manufacturer's instructions for use.

All unfinished (pre-primed) products must be painted within 12 months of installation. High quality, exterior grade, 100% acrylic latex paints are recommended.

DO NOT use stain, or oil or alkyd based paints on Nichiha products. Do not apply paint when siding is wet. Follow the manufacturer's instructions for use.

Nichiha does not warrant or accept liability for the appearance or performance of third party or field applied caulks, sealants, or finishes.

Periodic maintenance of the exterior of any structure is considered normal. As a guide, it is recommended that normal maintenance shall include:

Washing down the exterior surfaces periodically with a low pressure spray or garden hose to remove dirt and debris. DO NOT use high pressure power washers as they may damage the siding.

Reapplication of exterior finishes.

Please refer to your paint manufacturer for recoating requirements and schedules.

Maintaining caulks and sealants.

Ensure that gutters are clear and unclogged to prevent overflows.

Ensure the minimum ground clearance is maintained by preventing build up of decorative mulch, stone, etc.

Maintain a clearance between the siding and any vegetation, shrubs, etc.

SAVANNAH SMOOTH & SIERRA PREMIUM™ SHAKE INSTALLATION

PREPARATION

Follow all *General* instructions at the beginning of this guide.

Install Sierra Premium™ Shake and Savannah Smooth boards over vertical wood framing spaced no greater than 16" (406mm) o.c. with a required APA rated 7/16" (11mm) thickness (minimum) OSB or plywood sheathing. SIP and nailbase applications require the use of only screws for siding attachment.

Correct any misaligned framing as irregularities may mirror through finished applications.

Ensure all weather resistive barriers are in place in accordance with local code. All openings, corners, and transitions must have appropriate flashing to prevent moisture penetration. Follow moisture management best practices, WRB manufacturer's guidelines, window manufacturer instructions, and all local building codes. *Nichiha assumes no responsibility for moisture infiltration.*

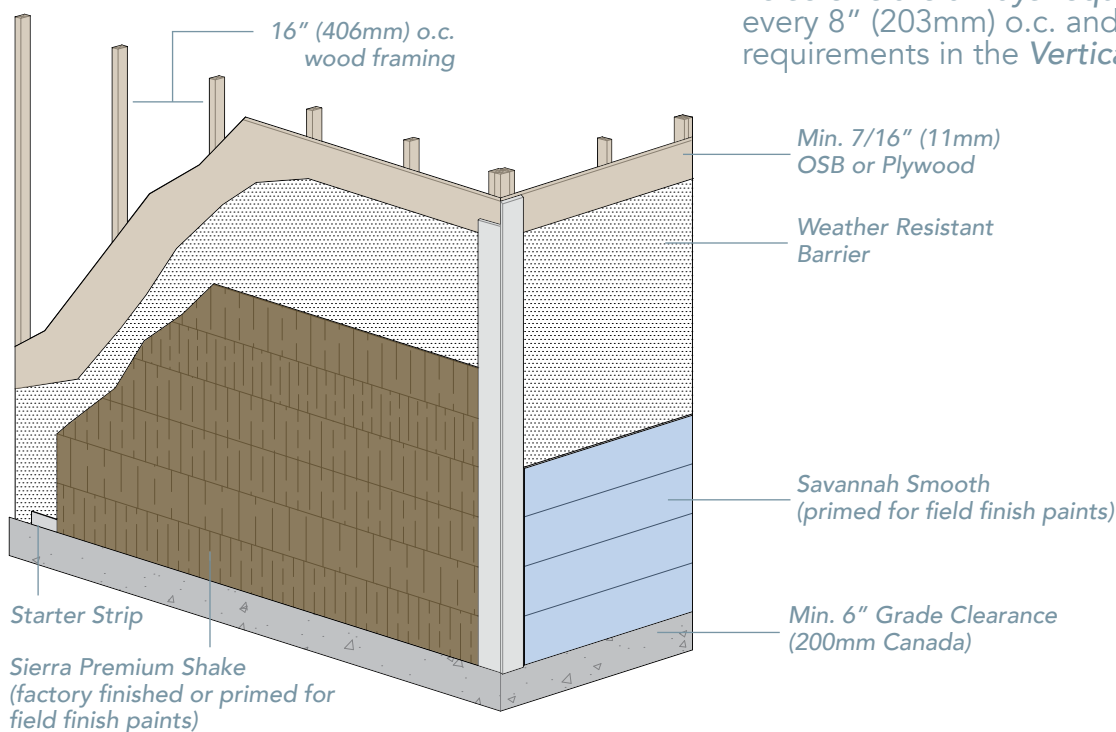

FASTENING

Follow all fastener requirements in the *General* section of this guide.

Sierra Premium™ Shake and Savannah Smooth boards must be installed with corrosion resistant, galvanized, or stainless steel fasteners.

Fastener heads must be flush to the board surface. Do not over drive or under drive fasteners.

WOOD STUDS WITH OSB/PLYWOOD

A corrosion resistant, #8, ribbed, bugle head (.375" HD) screw of appropriate length is recommended. Alternatively, at intermediate studs, a hot-dipped galvanized, full round head (min .221" HD) siding or roofing nail may be used. Refer to the appropriate code report ([Intertek CCRR-0299](#) for the U.S., [CCMC Report 14307-R](#) for Canada) to choose appropriate fasteners to meet the project's wind load design requirements. Fasteners must penetrate into wood a minimum of 1" (25mm), except at board ends/butt joints where #8 screws are required in keeping with the *Vertical Joints* section.

SIPs AND NAILBASE INSULATION SHEATHING

#8 screws are always required. Apply screws every 8" (203mm) o.c. and in keeping with the requirements in the *Vertical Joints* section.

STARTER STRIP & FIRST COURSE

A starter strip is required to set the first course on the proper angle and to create the drip edge at the bottom course of siding. The starter strip material may be a cut piece of fiber cement, PVC, or pressure treated lumber. Material about 1-1/2" (38mm) in height is sufficient. Do not use untreated lumber, plywood, OSB or other engineered wood products as a starter strip.

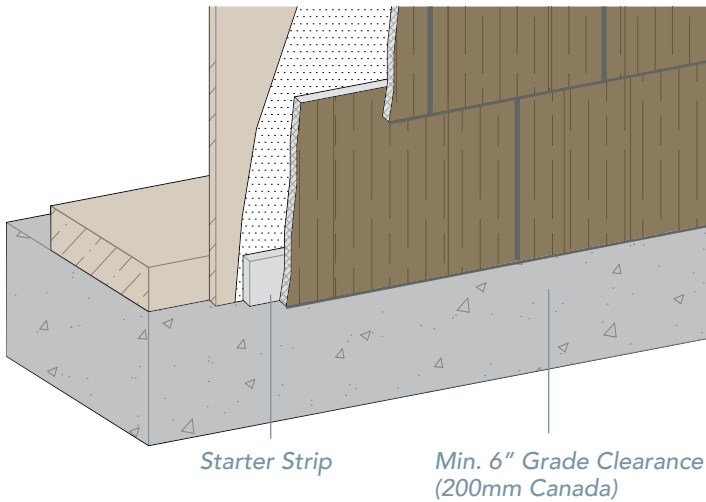

Install the starter strip level with the bottom of the wall sheathing or mudsill.

Ensure the first course of boards is level as it will be the guide for the entire installation. Use a level and chalk line (or laser level) to establish a level and straight reference point for the first course. Continue to check for level lines throughout installation.

The first course of siding must hang below the starter strip a minimum of 1/4" (6mm).

The siding should not extend below the corner trim.

The bottom edge of the first course must have at least 6" clearance (200mm in Canada) above finished grade.

It is recommended the course heights remain aligned and transfer around corners.

OVERLAP

Sierra Premium™ Shake and Savannah Smooth boards must be installed with a minimum overlap of 1 1/4" (31mm).

Alternatively, on Sierra Shake, a maximum overlap of up to but no greater than 2" (51mm) may be used.

1-1/4" (31mm) Overlap

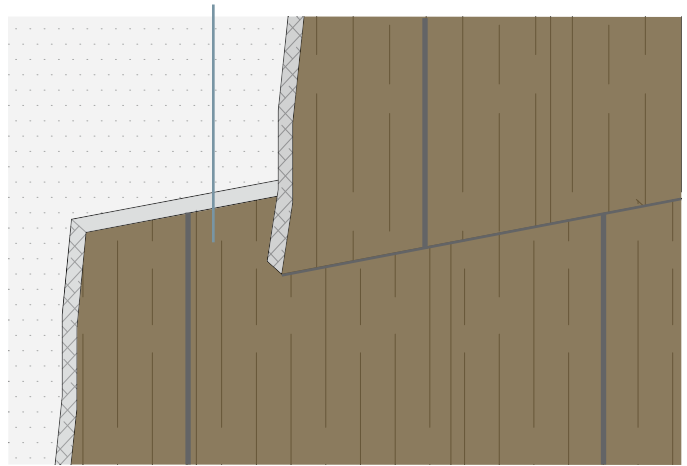

CUT (SHORTENED) BOARD COURSES

Where it may be necessary to rip (horizontally cut/shorten) boards to fit at terminating conditions such as window sills, under band board trim, or at the top of the wall at soffit, include a shim (similar to starter strip) to allow the Sierra/Savannah board to install with the proper rake angle.

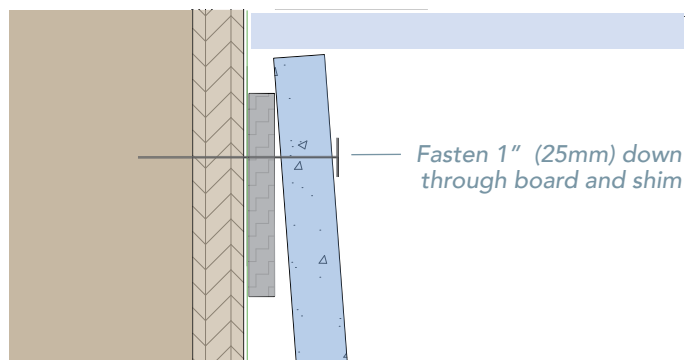

Top/Terminal Course Fastening

FASTENING METHODS

BLIND NAILING/FASTENING

For a more aesthetically pleasing installation, Savannah and Sierra boards may be installed in a hidden, or blind, fastener application.

When installing boards with nails, the board ends must be secured with a corrosion resistant, #8, ribbed, bugle head screw at each butt joint or termination. Position the screw 1" (25mm) back from board ends.

Position the *blind nail* fasteners a minimum of 1" (25mm) down from the top edge of the board.

Fasten from one end of the board to the other. The next course will conceal the fasteners in the 1-1/4" (31mm) overlap.

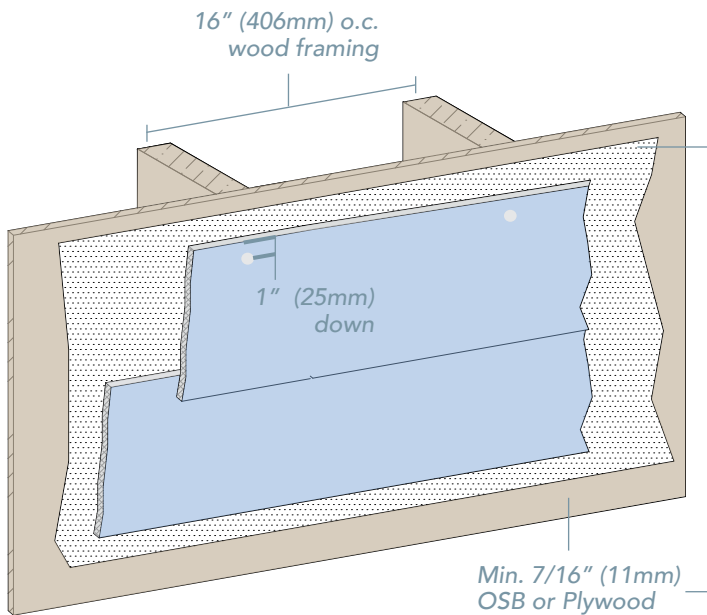

Blind Nail Fastening

FACE NAILING/FASTENING

It is permissible to install Sierra and Savannah boards in a face fastener type installation to meet certain installation requirements, such as wind design criteria or when specified by local code.

When installing boards with nails, the board ends must be secured with a corrosion resistant, #8, ribbed, bugle head screw at each butt joint or termination. Position the screw 1" (25mm) back from board ends.

Position the fasteners a minimum distance of 3/4" (18mm) up from the bottom edge of the board and no more than 1" (25mm). This ensures the fastener will penetrate through the overlap and through both courses.

Fasten from one end of the board to the other.

DO NOT intermix blind and face nail installation. Follow the same fastening schedule and method throughout the installation.

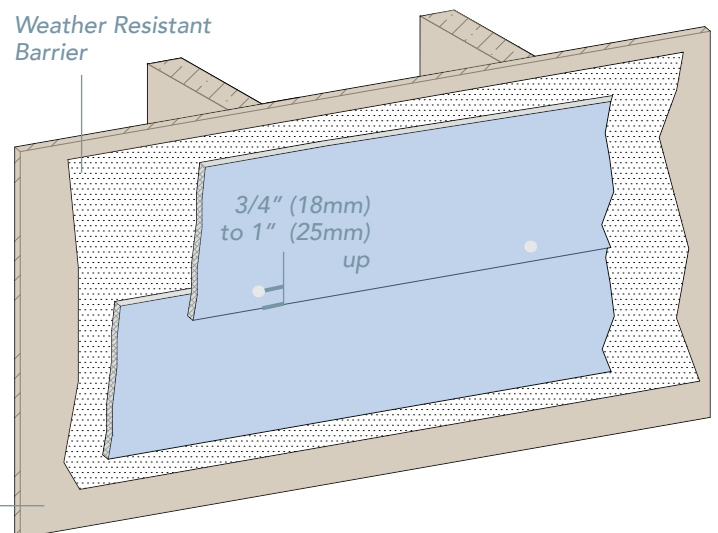

Face Nail Fastening

VERTICAL JOINTS

When possible, Savannah and Sierra board vertical (butt) joints should land or break over studs or solid wood framing.

Position the #8 screw 1" (25mm) from board ends and the appropriate distance from top or bottom edge, depending on fastening method (Blind or Face).

Pin-backs may be done for aesthetic purposes only. Pin backs shall be done with corrosion resistant finish nails only and are not a substitute for blind or face fastening.

When possible, use factory sealed or finished ends at butt joints.

ALL exposed field cut ends and edges must be sealed with a primer or paint. NEVER leave exposed cut edges uncoated. When using factory prefinished products, all exposed field cut ends and edges must be painted with a color matching, exterior grade, acrylic latex paint.

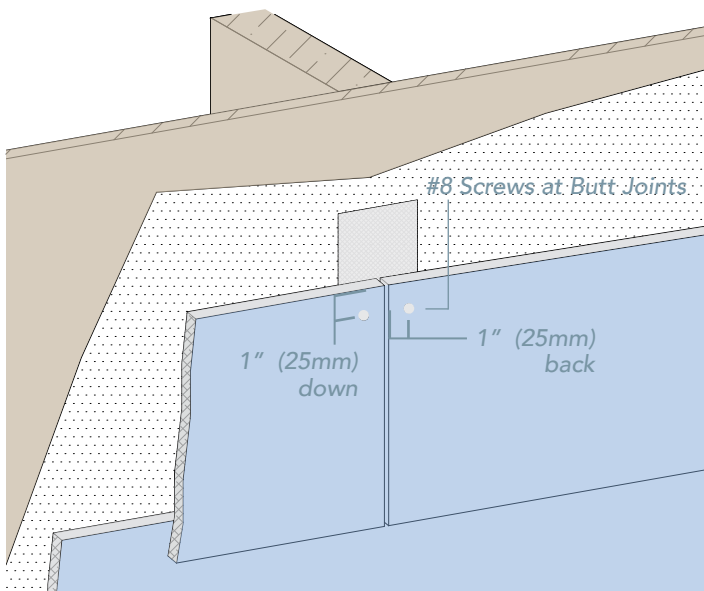

Blind Nail Fastening - Butt Joints

JOINT TREATMENT

The use of a joint flashing behind the butt joints is required.

Install Savannah and Sierra boards in moderate contact at butt joints.

Suitable materials for joint flashing include anodized or PVC coated coil stock and code approved weather/water resistive barriers.

The joint flashing should be at least 3" (76mm) in width and long enough to extend above the board height a minimum of 2" (51mm).

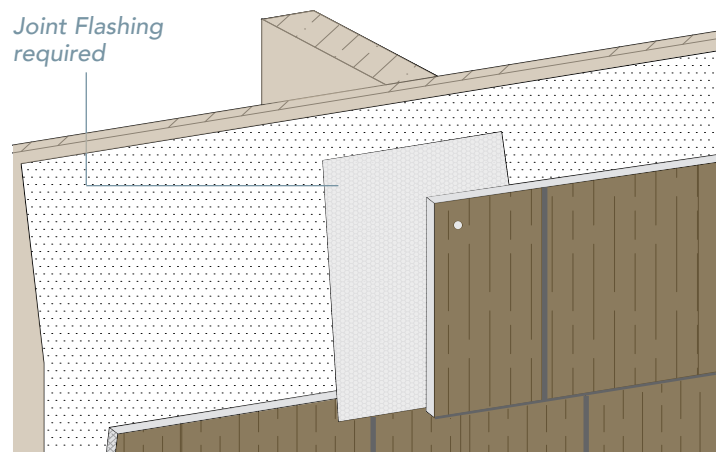

STAGGERING THE SHAKE BOARDS

More than one pattern of boards may exist within each unit of Sierra Premium Shake. Install Sierra Premium Shake boards in a manner which minimizes keyway alignment.

Install boards with ends over studs or solid wood framing when possible with a minimum 16" (406mm) stagger between courses.

For additional keyway alignment options, boards may be reversed, or incorporate an increased stagger amount. Layout of the application may be necessary to avoid repetition or stacked keyways.

SIDING TO TRIM JOINTS

Where board ends and edges meet vertical trim at inside and outside corners, door, window, and other trim attachments, leave a minimum 1/8" (3mm) gap and caulk with a quality sealant that meets ASTM C-920 requirements.

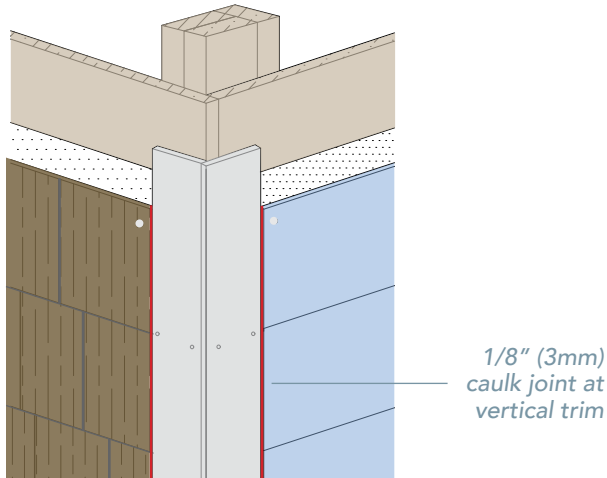

Corner trim and other trim attachments must be of sufficient thickness. The overlapped board siding must not extend beyond the face of the trim. Individual Sierra and Savannah boards are 12mm (~1/2") thick. A continuous, solid shim or build out behind the trim may be necessary.

All horizontal trim at window and door heads, decorative trim bands, etc. must be flashed. *Leave a 1/4" (6mm) gap between the siding and flashing. Do not caulk this gap.*

Do not use raw aluminum flashings. Flashings must be galvanized, anodized or PVC coated.

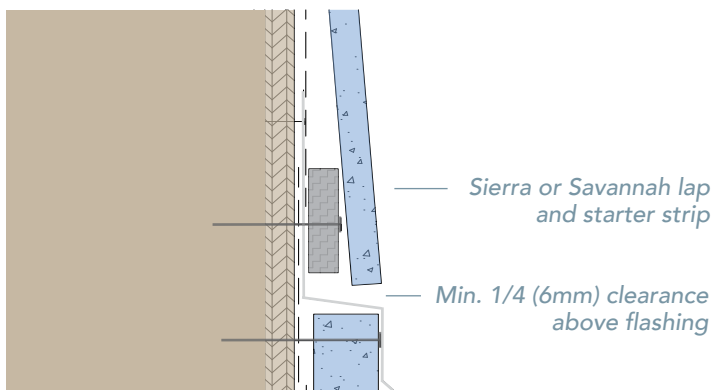

Flash Horizontal Trim Boards

OUTSIDE CORNER METHODS (ALT.)

Savannah and Sierra boards may be installed with mitered style corners. For best results, use a compound miter saw to accurately cut the 45 degree miter cut and slope angle.

Boards may also be installed in a laced or butted and staggered corner application.

Before installing board siding in a mitered or laced corner manner, the addition of a galvanized, coated aluminum, or vinyl/PVC flashing is required over the building corner.

Use a *polyurethane adhesive* where mitered or laced boards join. Caulks and/or sealants are not considered a proper adhesive.

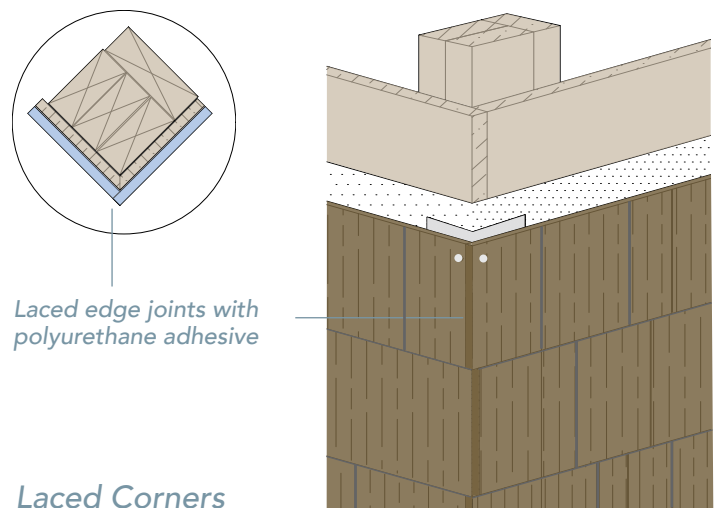
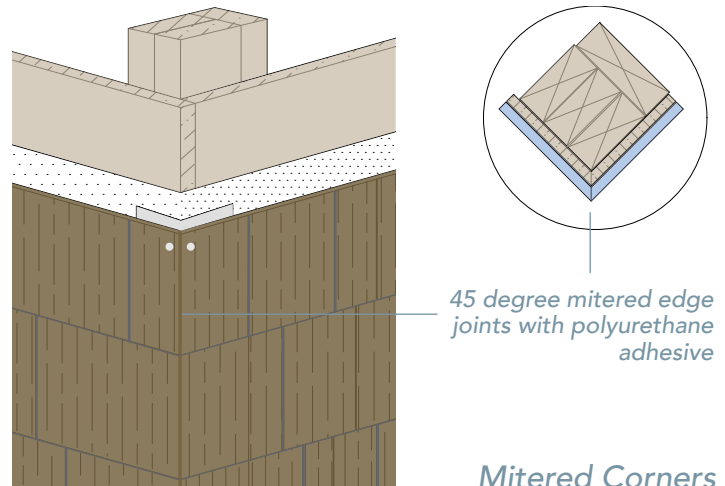

Never underestimate the power of really good tools

Whether you're an architect, a builder or a contractor, Nichiha wants to see to it that you have all the information you need to make your project go as smoothly as possible. The way we see it, we're partners.

Our website offers a comprehensive collection of technical information, Architectural details, in depth specifications and everything you'll ever need to know about installing Nichiha products. We invite and encourage you to visit our website at nichiha.com.

And by all means, if you have a troublesome question or comment, our ears are always open. Call us at 1.866.424.4421 or visit us at nichiha.com.

NICHIHA WARRANTIES

- Sierra Premium Shake and Savannah Smooth - 30-year limited warranty* on boards, 15-year limited warranty* on finish

*See Nichiha warranties for detailed information on terms, conditions, and limitations. Visit nichiha.com for easy downloadable warranties or call toll-free 1.866.424.4421 for a copy.

Nichiha SDS are also available on our website.

Certification & testing:



FL# 12785 with HVHZ



LARR 26169



WUI 8140-2029



EC-58

* Silica Dust Warning: NICHIHA products may contain some amounts of crystalline silica [a.k.a. sand, silicon dioxide], which is a naturally occurring mineral. The amount will vary from product to product. Inhalation of crystalline silica into the lungs and repeated exposure to silica can cause health disorders, such as silicosis, lung cancer, or death depending upon various factors. To be conservative, Nichiha recommends that whenever cutting, sawing, sanding, sniping or abrading the product, users observe Safety Instructions. For further information or questions, please consult the MSDS, your employer, or visit www.osha.gov/SLTC/silicacrystalline/index.html and www.cdc.gov/niosh/topics/silica. The MSDS for Nichiha products are available at www.nichiha.com, at your local Nichiha dealer or through Nichiha directly at 1.866.424.4421. FAILURE TO ADHERE TO OUR WARNINGS, MSDS, AND OTHER INSTRUCTION MAY LEAD TO SERIOUS PERSONAL INJURY OR DEATH.