

Adhesive Anchoring Installation Instructions

Note: Always check expiration date on product label. Do not use expired product.



- For best results, adhesive should be conditioned to a temperature between 70°F (21°C) and 80°F (37°C) at the time of installation.
- To warm cold adhesive, store cartridges in a warm, uniformly heated area or storage container. Do not immerse cartridges in water or use microwave to facilitate warming.



Warning: When drilling and cleaning hole, use eye and lung protection. When installing adhesive, use eye and skin protection.

1A. Hole Preparation — Horizontal, Vertical and Overhead Applications (SET-3G™ and AT-3G™ for anchor installation) and (AT-3G for post-installed rebar connections)

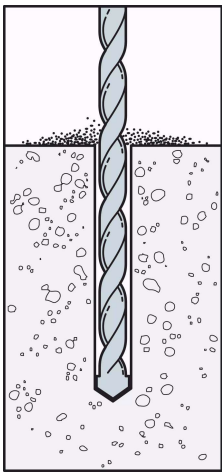

1. Drill — Drill hole to specified diameter and depth.

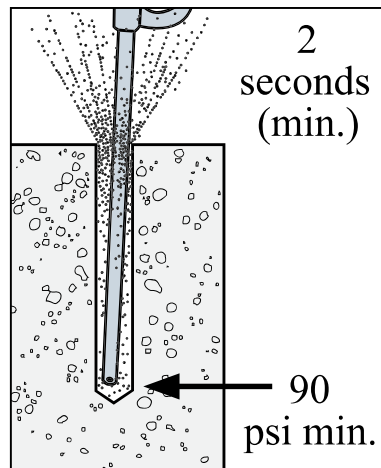

2. Blow — Remove dust from hole with oil-free compressed air for a minimum of two seconds. Compressed air nozzle must reach the bottom of the hole.

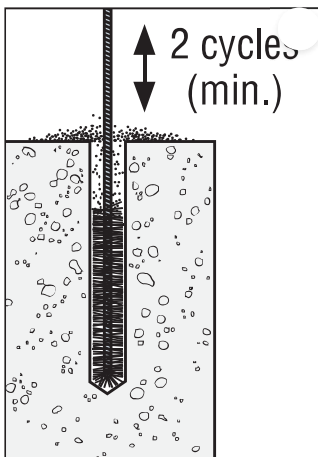

3. Brush — Clean with a steel wire brush for a minimum of two cycles. Brush should provide resistance to insertion. If no resistance is felt, the brush is worn and must be replaced.*

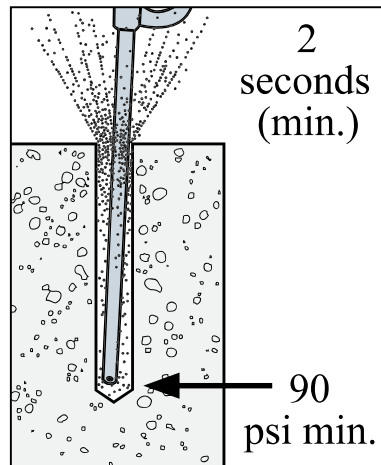

4. Blow — Remove dust from hole with oil-free compressed air for a minimum of 2 seconds. Compressed air nozzle must reach the bottom of the hole.

Hole Preparation — Horizontal, Vertical and Overhead Applications (ET-3G™) and (SET-3G for post-installed rebar connections only)

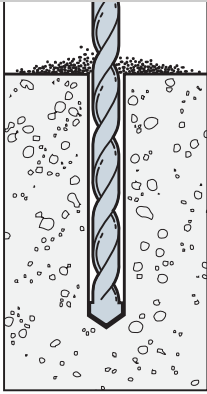

1. Drill — Drill hole to specified diameter and depth.

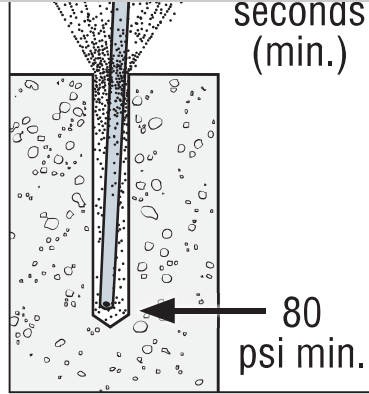

2. Blow — Remove dust from hole with oil-free compressed air for a minimum of four seconds. Compressed air nozzle must reach the bottom of the hole.

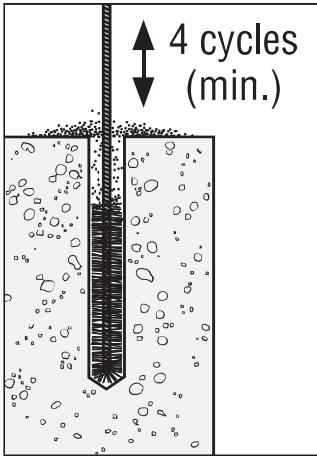

3. Brush — Clean with a nylon brush for a minimum of four cycles. Brush should provide resistance to insertion. If no resistance is felt, the brush is worn and must be replaced.*

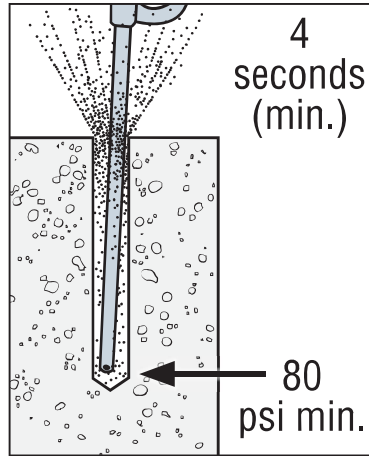

4. Blow — Remove dust from hole with oilfree compressed air for a minimum of four seconds. Compressed air nozzle must reach the bottom of the hole.

1B. Hole Preparation Vacuum Dust Extraction System with the Simpson Strong-Tie DXS Hollow Carbide Drill Bit* — Horizontal, Vertical and Overhead Applications

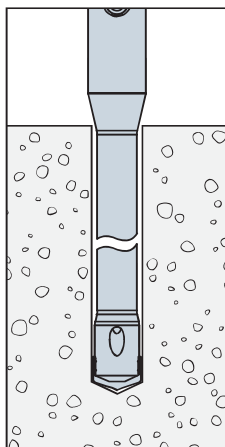

1. Drill — Drill hole to specified diameter and depth using the Simpson Strong-Tie DXS hollow carbide drill bit and vacuum dust extraction system.*



Simpson Strong-Tie DXS drill bit used with the vacuum dust extraction system.*

* Note: Visit strongtie.com for tested and accepted hollow carbide drill bit and vacuum dust extraction systems.

1C. Hole Preparation — Submerged Applications (SET-3G only)

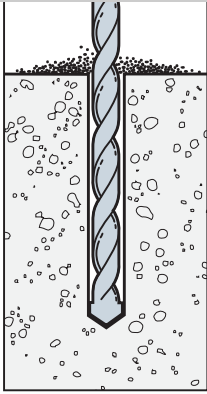

1. Drill — Drill hole to specified diameter and depth.

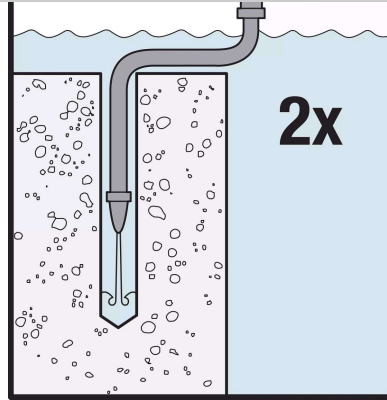

2. Flush — Remove slurry from hole by flushing hole twice with water until water runs clear.

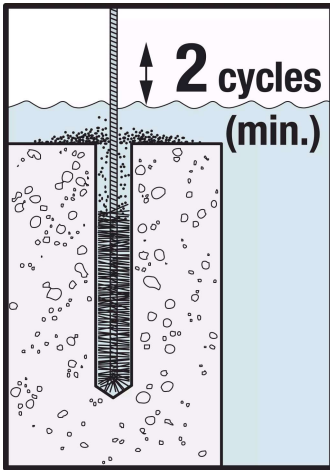

3. Brush — Clean with a steel wire brush for a minimum of two cycles. Brush should provide resistance to insertion. If no resistance is felt, the brush is worn and must be replaced.*

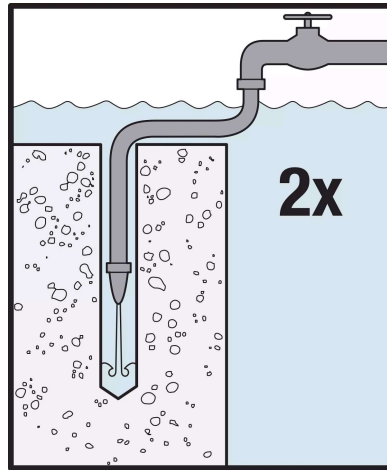

4. Flush — Remove slurry from hole by flushing hole twice with water until water runs clear.

2. Cartridge Preparation



1. Check — Check expiration date on product label. Do not use expired product.



2. Open — Open cartridge per package instructions.

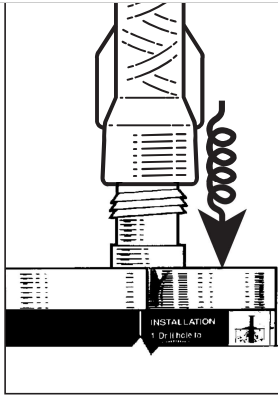

3. Attach — Attach proper Simpson Strong-Tie nozzle and extension to cartridge. Do not modify nozzle.

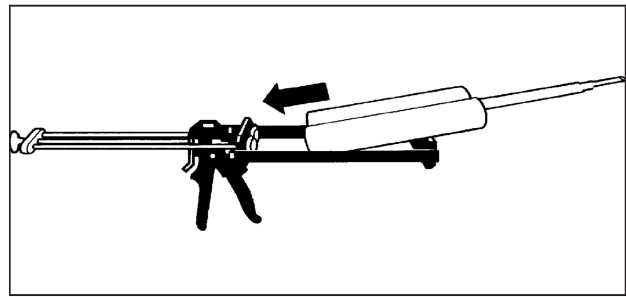

4. Insert — Insert cartridge into dispensing tool.

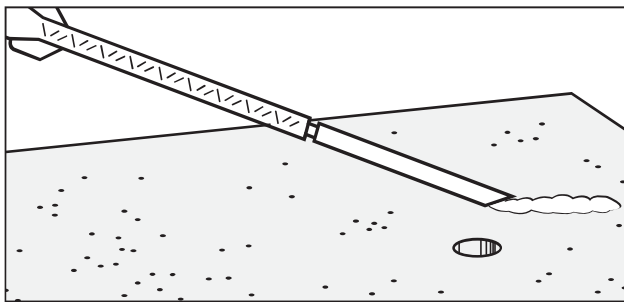

5. Dispense — Dispense adhesive to the side until properly mixed (uniform color).

For Solid Base Materials

3A. Filling the Hole — Vertical Anchorage

Prepare the hole per “1. Hole Preparation” instructions above.

Dry and Damp Holes

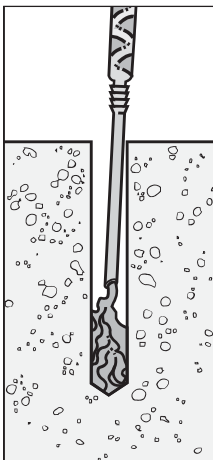

1. Fill — Fill hole 1/2 – 2/3 full, starting from bottom of hole to prevent air pockets. Withdraw nozzle as hole fills up.

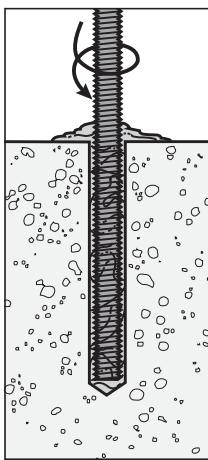

Threaded rod or rebar

2. Insert — Insert clean, oil free anchor, turning slowly until the anchor contacts the bottom of the hole.

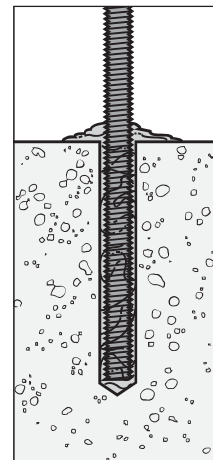

3. Do not disturb — Do not disturb anchor until fully cured. (See cure schedule for specific adhesive.)

Water Filled Holes

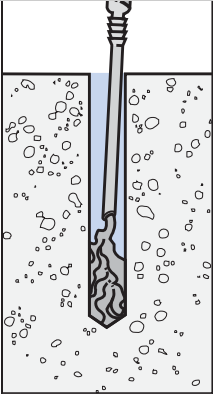

1. Fill — Fill hole completely full, starting from bottom of hole to prevent water pockets. Withdraw nozzle as hole fills up.

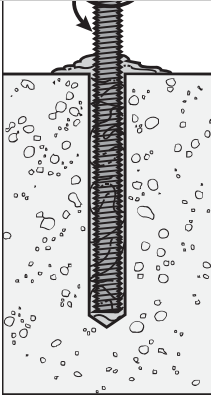

Threaded rod or rebar
2. Insert — Insert clean, oil-free anchor, turning slowly until the anchor contacts the bottom of the hole.

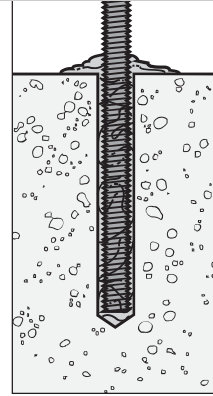

3. Do not disturb — Do not disturb anchor until fully cured. (See cure schedule.)

i **Note:** Nozzle extensions may be needed for deep holes.

3B. Filling the Hole — Horizontal and Overhead Anchorage

Prepare the hole per instructions above, “1. Hole Preparation”.

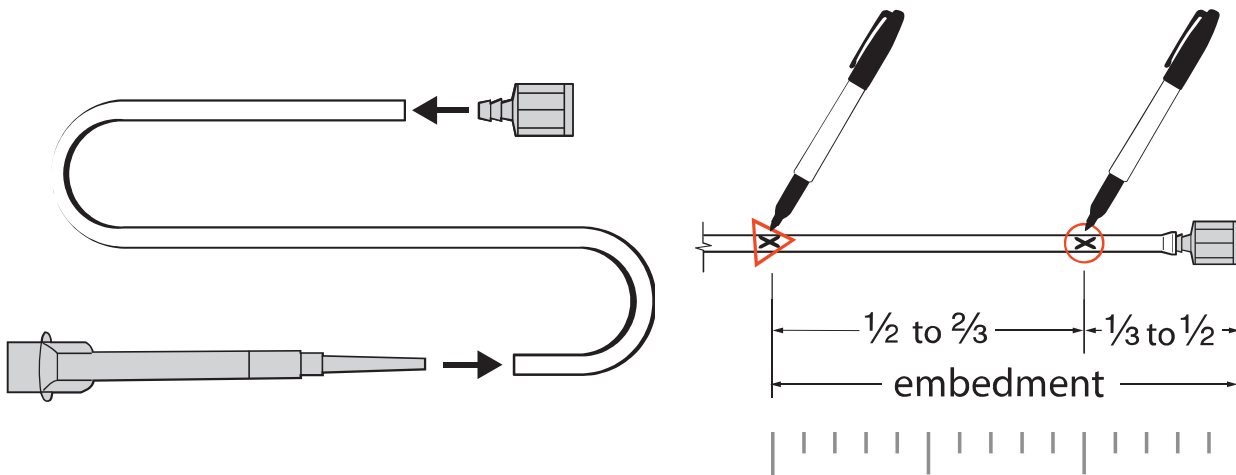

Step 1.

- Attach the piston plug to one end of the flexible tubing (PPFT25).
- Cut tubing to the length needed for the application, mark tubing as noted below and attach other end of tubing to the mixing nozzle.
- If using a pneumatic dispensing tool, regulate air pressure to 80-100 psi.

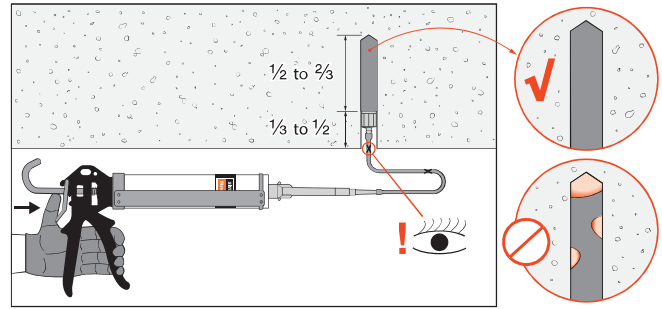
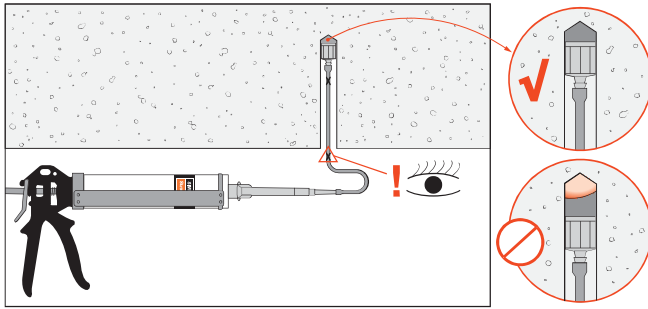

Step 2.

- Insert the piston plug to the back of the drilled hole and dispense adhesive

Step 3.

- Fill the hole 1/2 to 2/3 full
- **Note:** As adhesive is dispensed into the drilled hole, the piston plug will slowly displace out of the hole due to back pressure, preventing air gaps.

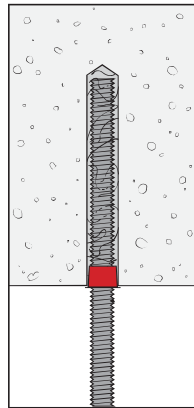
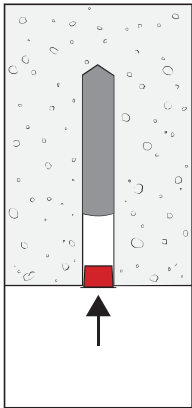

Step 4.

- Install the appropriate Simpson Strong-Tie adhesive retaining cap.

Step 5.

- Place either threaded rod or rebar through the adhesive retaining cap and into adhesive-filled hole. Turn rod/rebar slowly until the insert bottoms out. Do not disturb until fully cured.

3C. Filling the Hole — Submerged Anchorage (SET-3G™ only)

Prepare the hole per “Hole Preparation” instructions on product label.

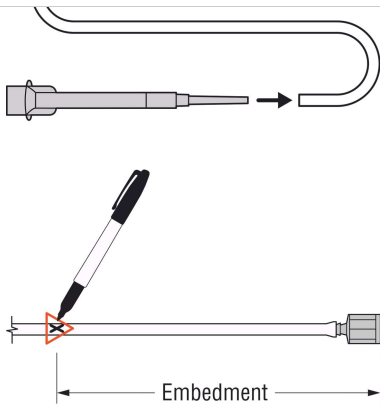

Step 1.

- Attach the piston plug to one end of the flexible tubing (PPFT25).
- Cut tubing to the length needed for the application, mark tubing as noted below and attach other end of tubing to the mixing nozzle.
- If using a pneumatic dispensing tool, regulate air pressure to 80–100 psi.

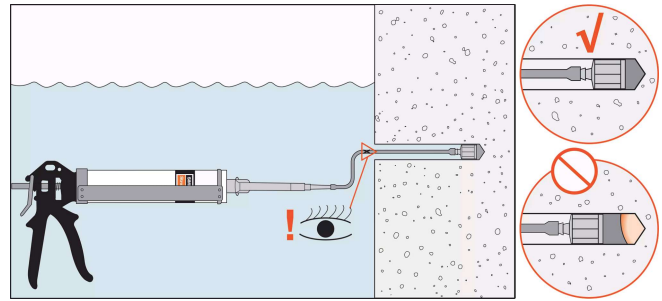

Step 2. Insert the piston plug to the back of the drilled hole and dispense adhesive.

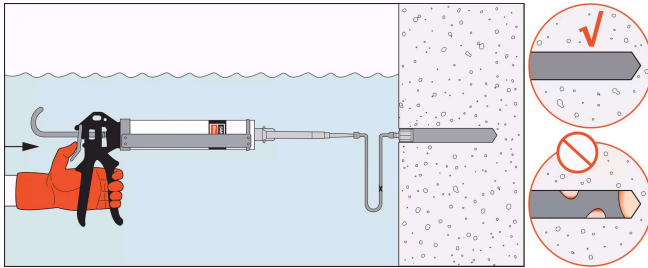

Step 3. Fill the hole completely full.

Note: As adhesive is dispensed into the drilled hole, the piston plug will slowly displace out of the hole due to back pressure, preventing air gaps.

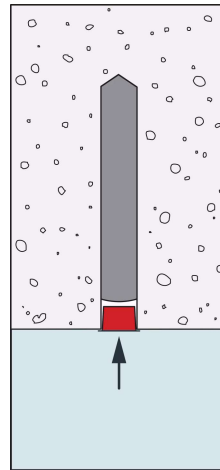
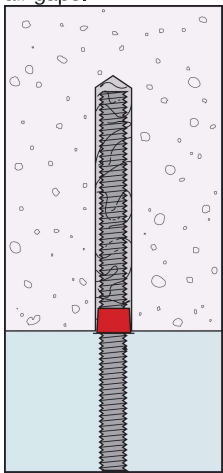

Step 4.

- Install the appropriate Simpson Strong-Tie adhesive retaining cap.

Step 5.

- Place either threaded rod or rebar through the adhesive retaining cap and into adhesive filled hole.
- Turn rod/rebar (marked with the required embedment depth) slowly until the insert bottoms out.
- Do not disturb load or torque anchor until fully cured.



3D. Filling the Hole — For Hollow Base Material Installations.

Prepare the hole per instructions above, "1. Hole Preparation".

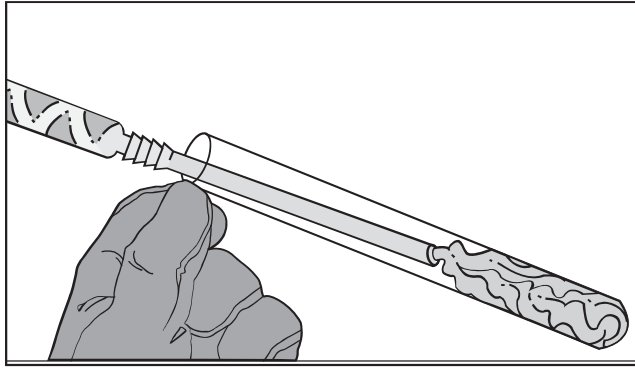

1. Fill — Fill screen completely. Fill from the bottom of the screen and withdraw the nozzle as the screen fills to prevent air pockets. (Close integral cap after filling.)

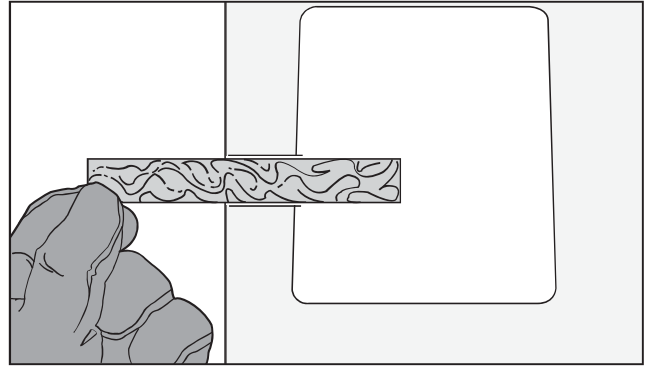

2. Insert — Insert adhesive-filled screen into hole.

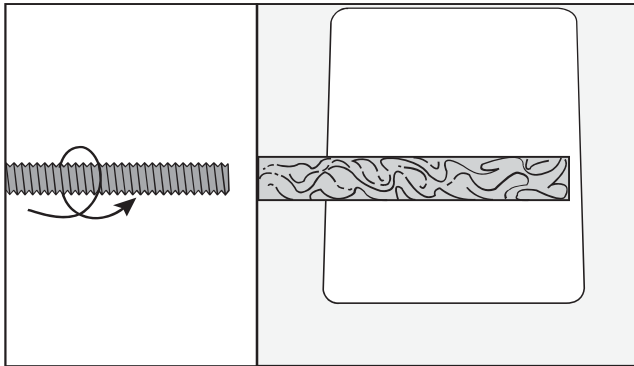

3. Insert — Insert clean, oil-free anchor, turning slowly until the anchor contacts the bottom of the screen.

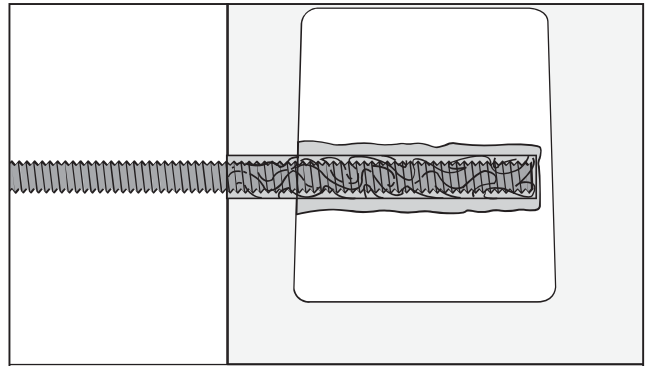

4. Do not disturb — Do not disturb anchor until fully cured. (See cure schedule for specific adhesive.)

For Unreinforced Brick Masonry

1. Hole Preparation — For Configurations A (Horizontal) and B (22 1/2° Downward) Installations with a Carbide-Tipped Drill Bit.

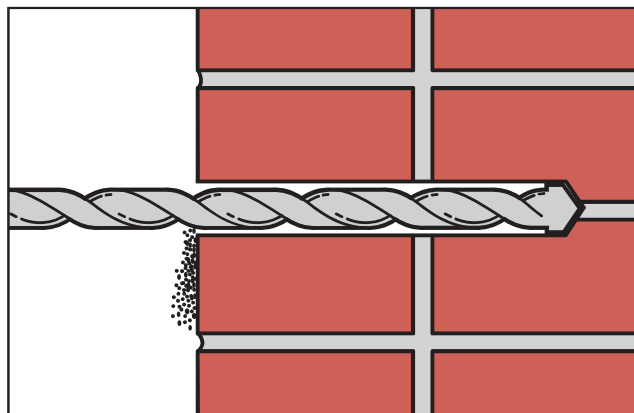

1. Drill — Drill 1"-diameter hole to specified depth with a carbide-tipped drill bit, using rotation only mode. For Configurations A, drill 8" deep. For Configuration B, drill to within 1" of the opposite side of wall (minimum 13" deep).

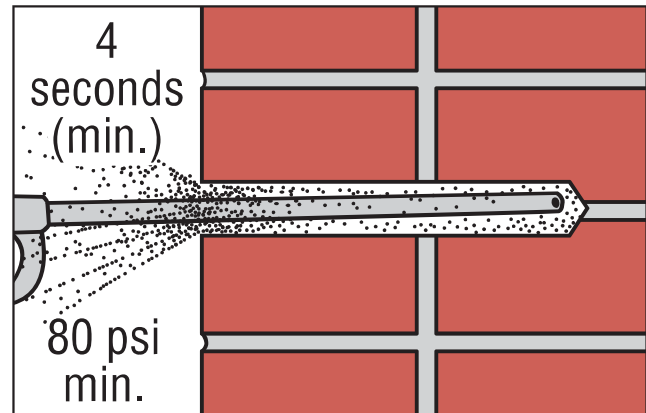

2. Blow — Remove dust from hole with oil-free compressed air for a minimum of four seconds. Compressed air nozzle **MUST** reach the bottom of the hole.

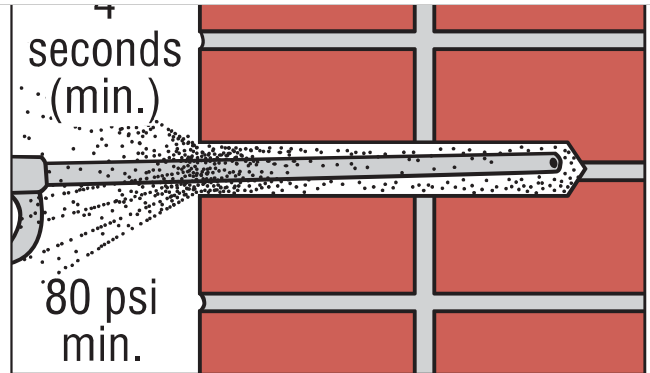
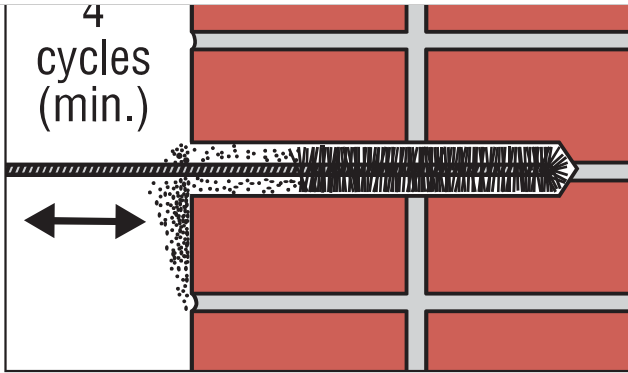

3. Brush — Clean with a nylon brush for a minimum of four cycles. Brush **MUST** reach the bottom of the hole. Brush should provide resistance to insertion. If no resistance is felt, the brush is worn and must be replaced.

4. Blow — Remove dust from hole with oil-free compressed air for a minimum of 4 seconds. Compressed air nozzle **MUST** reach the bottom of the hole.

2. Cartridge Preparation

Reference above for cartridge preparation.

3. Filling the Hole — For Configurations A (Horizontal) and B (22 1/2°-Degree Downward) Installations.

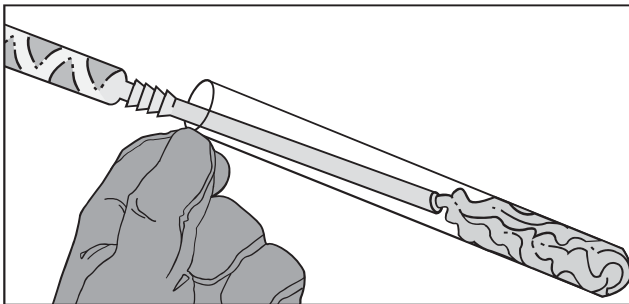

1. Fill — Fill screen completely. Fill from the bottom of the screen and withdraw the nozzle as the screen fills to prevent air pockets.

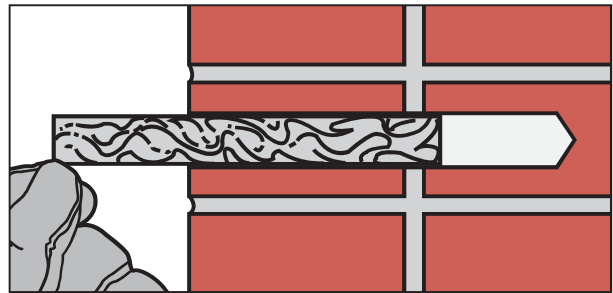

2. Insert — Insert adhesive filled screen into hole.

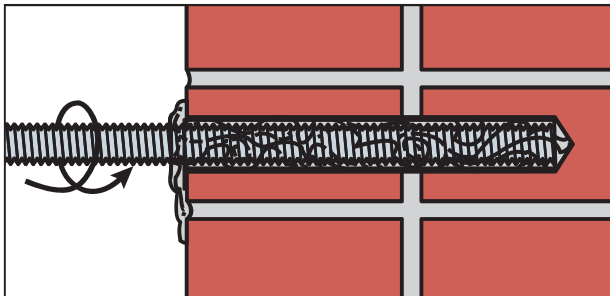

3. Insert — Insert clean, oil-free anchor, turning slowly until the anchor contacts the bottom of the screen.

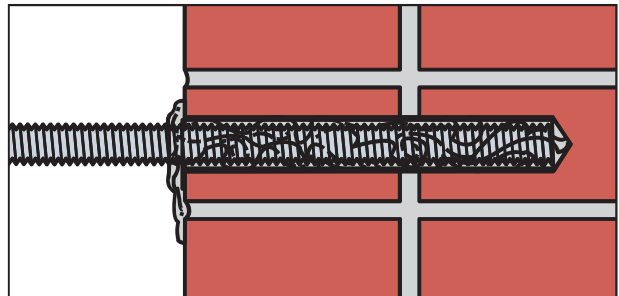

4. Do not disturb — Do not disturb anchor until fully cured. (See cure schedule for specific adhesive.)



Note: Steel wire mesh screens may be used for Configurations A and B.

About Simpson Strong-Tie

Careers

Social Impact

Product Use & Corrosion Info

Blogs & Podcast

Subscribe to Our Newsletter

By checking this box, I agree to receive communications from Simpson Strong-Tie in accordance with their [privacy policy](#).

Connect With Us



[Privacy Policy](#)

[User Agreement](#)

[Limited Warranties](#)

[Terms & Conditions](#)