

**USG CELEBRATION™
SNAP-IN**
CEILING SYSTEM

INSTALLATION GUIDE



IT'S YOUR WORLD. BUILD IT.™

SYSTEM OVERVIEW

USG CELEBRATION™ SNAP-IN CEILING SYSTEM

USG Celebration™ Snap-In Ceiling System offers a contemporary look, with a concealed suspension system, creating the illusion of panels floating within their reveal. USG Celebration Snap-In panels are supported by testing for a variety of installation requirements, including Miami-Dade NOA, for exterior applications with proper bracing and framing.

For exterior application details, refer to the *USG Exterior Ceilings Installation Guide (SC3212)* and the *USG Exterior Ceilings Application Guide (SC2561)*.

NOTES

Follow proper safety and industrial hygiene practices when handling and installing all products and systems. Take necessary precautions and wear appropriate personal protective equipment as needed. When removing ceiling products, we recommend wearing a dust mask, cut-resistant gloves and eye protection. Provide drop cloths to cover and protect furnishings below. When using a ladder or lift, follow the equipment manufacturer's precautions, instructions and safety guidelines.

All ceiling products and systems must be installed and maintained in accordance with current USG written instructions and in compliance with ASTM C636, ASTM E580, CISCA and standard industry practices.

Care must be taken to safeguard products from damage during delivery and while they are stored at the job site. Products must always be protected from vibration, chemical fumes and direct contact with water both before and after installation.

COMPONENTS

PANELS

Field panels are located in the field of the ceiling, not on the perimeter.

Perimeter panels are located on the edge or perimeter of the room. They may need to be cut.

SUSPENSION SYSTEM

DXF main tees are the main tees for the system and have a standard length of 12 ft.

DXF 4 ft. cross tees are standard 4 ft. cross tees for the system.

DXF 2 ft. cross tees are standard 2 ft. cross tees for the system.

U-2-3/32 channel moldings are aluminum channel molds with a standard length of 12 ft.

ACCESSORIES

U-2-3/32 hold down clips are perimeter hold down clips for the U-2-3/32 channel molding with a standard length of 10 in.

Arrowhead reveal spacers come in 100 ft. rolls and are installed adjacent to cut perimeter panels or when field panels are installed adjacent to light fixtures.

12 gauge hanger wires are a common building product used to suspend acoustical, drywall and specialty ceilings that are galvanized for corrosion resistance.

COMPONENTS

PANELS

Field Panel

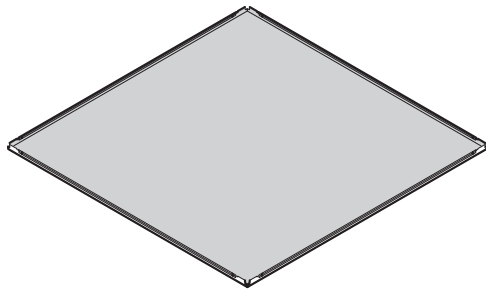

Perimeter Panel

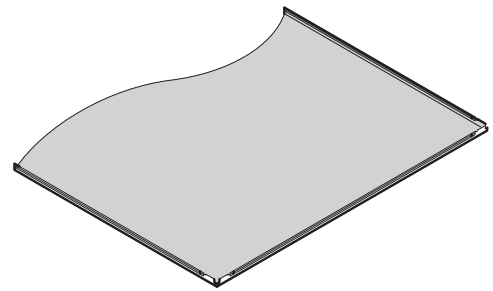

SUSPENSION SYSTEM

DXF Main Tee

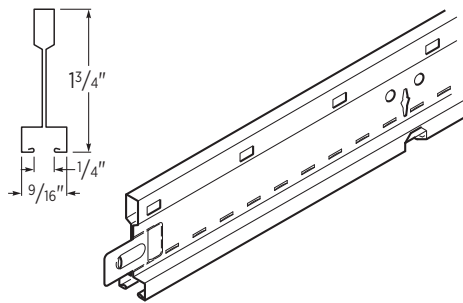

DXF 4 ft. Cross Tee

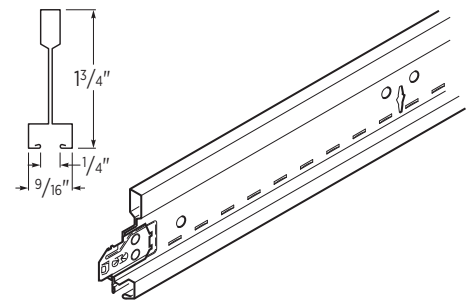

DXF 2 ft. Cross Tee

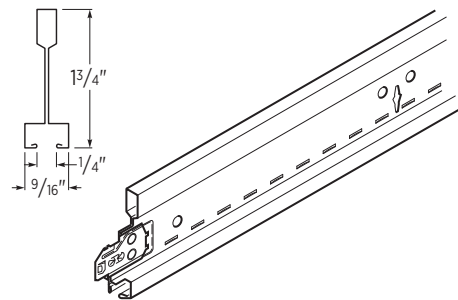

U-2-3/32 Channel Molding

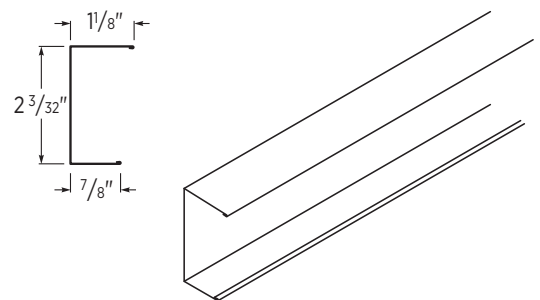

COMPONENTS

ACCESSORIES

U-2-3/32 Hold Down Clip

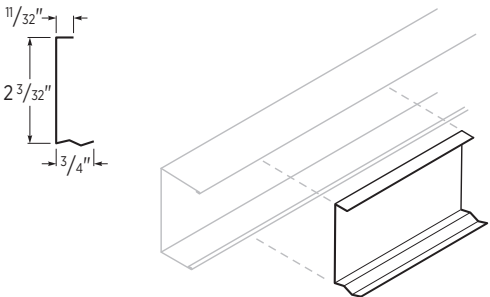

Arrowhead Reveal Spacer

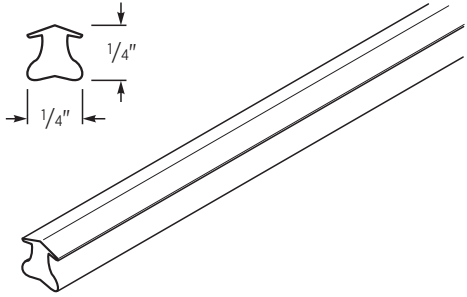

12-Gauge Hanger Wire

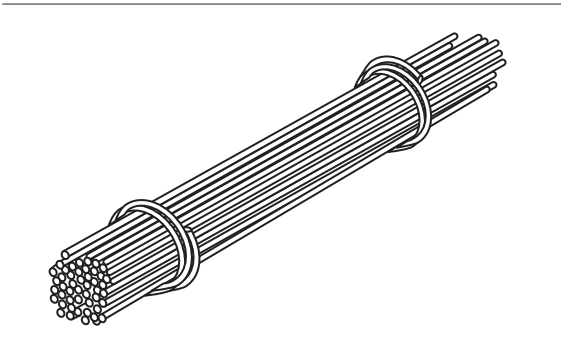

INTERIOR INSTALLATION

STEP 1 Determine the finished ceiling height

- Refer to the project documents to determine the finished ceiling height.
- Allow clearance of at least 4 in. below the lowest pipe or beam to the top of the suspension system. Snap a chalk line $\frac{3}{4}$ in. above the desired ceiling height.

Note: Certain light fixtures or utilities may require additional clearance.

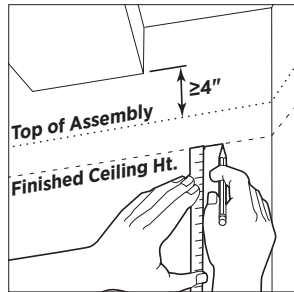

STEP 2 Mark the ceiling height at the perimeter

- Mark your finished ceiling height and set your laser $2\frac{1}{8}$ in. above the ceiling height to indicate the top of the U-2-3/32 perimeter molding. Adjust accordingly if an alternative perimeter molding is used, such as M7.

Note: For seismic installations, use M7 perimeter molding with ACM7 clips at the finished ceiling height. Refer to the Seismic Perimeter Applications sections in the *USG Exterior Ceiling Applications System Guide (SC2561)*.

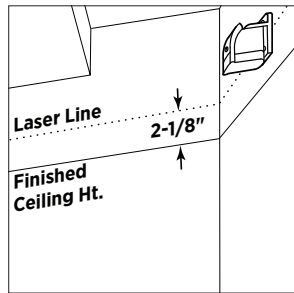

STEP 3 Install perimeter molding

- Mechanically fasten the U-2-3/32 perimeter molding at each stud location or at a maximum of 24 in. on center intervals.

Note: The $\frac{7}{8}$ in. leg of the U-2-3/32 perimeter molding shall be installed in the lower horizontal position.

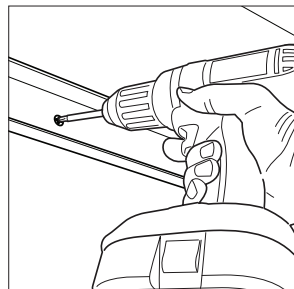

INTERIOR INSTALLATION

STEP 4

Locate the main tees

- For main tee spacing and layout, refer to the construction documents and the *USG Celebration™ Snap-In System Guide (IC415)*.
- Install a string line at the location of the first main tee, underneath the U-2-3/32 perimeter molding.

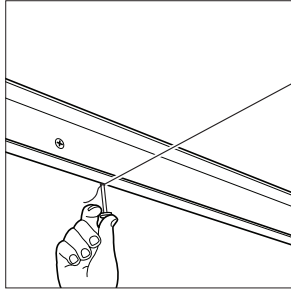

STEP 5

Locate Cross Tees

- Stretch a string perpendicular to the main tee strings to mark the first row of cross tees only (see Figure A). Main tees are equipped with prepunched slots for aligning the remaining cross tees.
- Both the strings should be squared at their intersection to form a 90-degree angle (see Figure B). Verify accuracy using the 3, 4, 5 triangle method. The suspension system must be square to function properly.

Tip: If the string lines need to be adjusted, move the strings toward the nearest wall.

Figure A

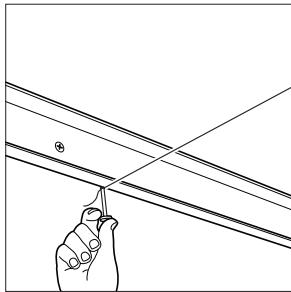
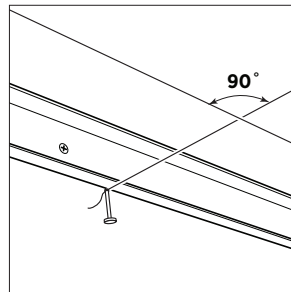

Figure B



INTERIOR INSTALLATION

STEP 6

Install hanger wires

- For hanger wire spacing and layout, refer to the construction documents and the *USG Celebration™ Snap-In System Guide* (IC415). Attach a hanger wire to the structure and then cut the wire 6 in. below the string line (see Figure A).

Tip: Use pliers to bend a 90-degree angle in all hanger wires at a point 3/4 in. above the perimeter molding. If the nearest hanger hole is not directly below the screw eye, adjust the hanger accordingly (see Figure B).

Figure A

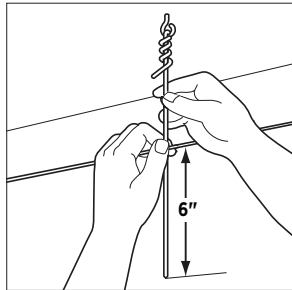
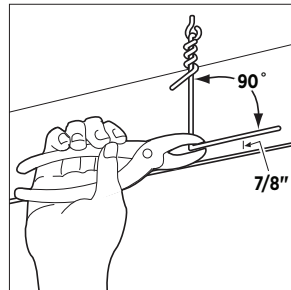

Figure B



STEP 7

Install the first main tees

- In each row, trim the first main tee at the wall so that the slots for the first row of cross tees line up at the string. Rest the cut end of the main tee on the wall angle.

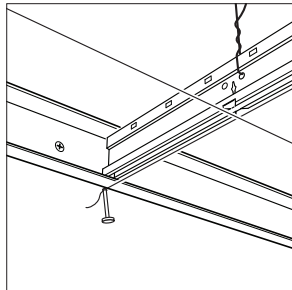

STEP 8

Suspend main tees

- Pull each hanger wire through a hanger hold located at the cross tee slots of the main tee and bend up. Adjust the height of the main tees as needed, and make sure the system is level. Then, wrap the wire end securely around itself with three complete turns within 3 in. Ensure the remaining wire end is secured so that it does not interfere with the placement of other ceiling components.

Note: Some local jurisdictions require additional wire wraps. If uncertain of the local requirements, check with a local official prior to installing the suspended ceiling system.

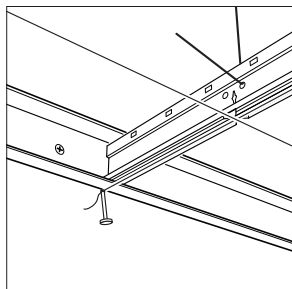

INTERIOR INSTALLATION

STEP 9

Install cross tees

- After the main tees are hung, install the cross tees. Push a cross tee end through the main tee slot until you hear a "click." Where two cross tees intersect in the same slot, be sure to insert the second tee to the left of the first. The grid system should be checked periodically to ensure the system is square during the installation of the cross tees.

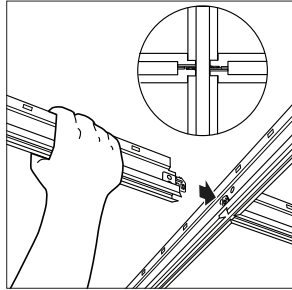

STEP 10

Secure perimeter tees

- Secure all perimeter tees to the wall molding by installing framing screws through the top leg of the wall molding into the bulb of the suspension system tees.

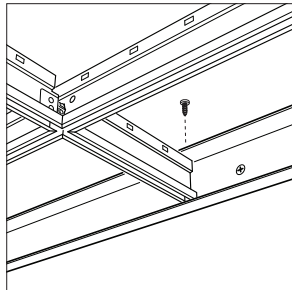

STEP 11

Cut perimeter panels

- Measure the perimeter panel dimension from the back of the wall molding to the inside leg of the Fineline box. Mark the appropriate cut points onto a full panel. Cut the panels utilizing a circular saw with a high tooth count carbide tip blade. To prevent deflection in the panel during the cutting process, place an appropriately sized acoustical panel or piece of drywall inside the USG Celebration panel before cutting.

Note: Cut the panels face up. Use care to avoid damaging the finish.

Celebration panels shall be installed in a one-direction pattern. A line on the back of each panel marks the direction of the grain in the material. To install these panels in a one-direction pattern, make sure all the lines are pointing in the same direction. This will ensure that an even shade of ceiling results throughout the entire area. If installed with the grain going one direction and then changing, a checkboard effect will result (light and dark areas) on your ceiling.

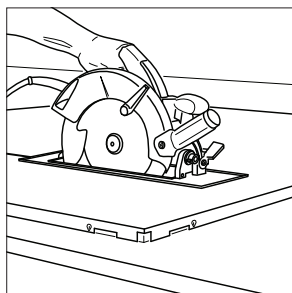

INTERIOR INSTALLATION

STEP 12

Install perimeter panels

- Panel installation should begin with the corner pieces followed by the perimeter panels starting from both sides of each corner. Perimeter panels are installed by first placing the cut end of the perimeter piece on top of the lower leg of the perimeter molding and then pushing the remaining panel edge into the DXF suspension system. Place one U-2-3/32 hold down clip along the edge of each linear foot of perimeter panel (see Figures A and B).

Figure A

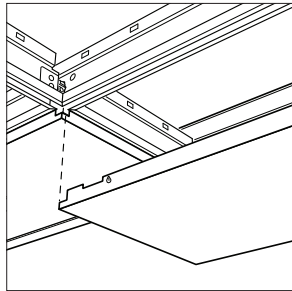
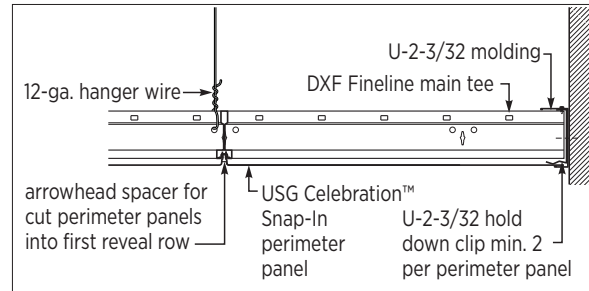

Figure B



STEP 13

Install field panels.

- To install the field panels, place each panel onto the flange of the grid (see Figure A) and press along the panel edge to lock it into place (see Figure B). This could take some effort, but remember to only press on the outer edge of the panel to prevent damage. Do not press on the panel face.

Figure A

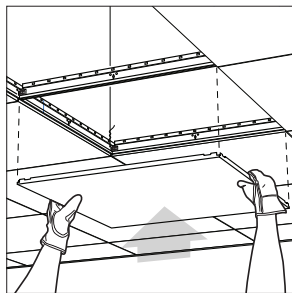
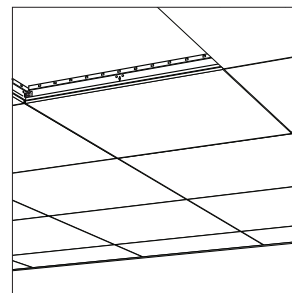

Figure B



INTERIOR INSTALLATION

STEP 14

Install reveal spacers

- For a field panel installed adjacent to a cut perimeter panel, insert a 4 in. length of arrowhead reveal spacer into the channel at each corner.
- For a field panel installed adjacent to an air diffuser or light fixture, insert 4 in. round reveal spacers into the channel at each corner.
- Repeat this process for each panel until all the spacers have been installed.

Note: Use a special cold environment arrowhead reveal spacer when installing USG Celebration Snap-In ceiling systems in environments where the temperature may drop below 5°F (-15°C). The cold environment spacer is available in 250 LF rolls and can be purchased through RTQ. Please contact customer service for more information.

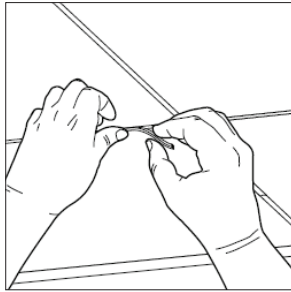

PANEL REMOVAL

STEP 1 Remove adjoining arrowhead spacers

- Using a screwdriver or appropriate tool, remove the arrowhead spacers from the reveal adjoining the panel(s) to be removed.

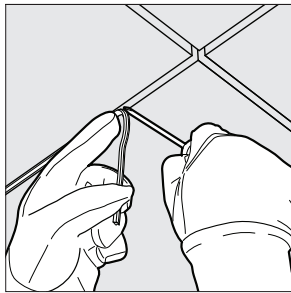

STEP 2 Locate removal slot and engage access tool

- Engage the USG Celebration™ access tool in a panel removal slot.

Note: Slots are typically located approximately 3 in. from panel corners and are located on all four panel sides.

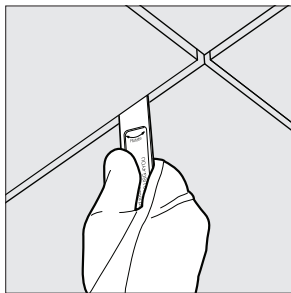

STEP 3 Support panel

- Ensure panel is sufficiently supported such that it does not deflect significantly when access tool is engaged.

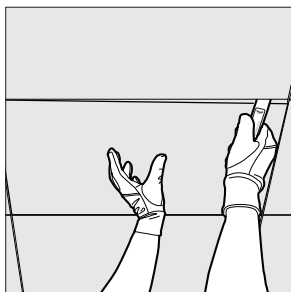

PANEL REMOVAL

STEP 4 Rotate access tool in direction of reveal

- Once access tool is engaged and panel is supported, rotate the tool in the direction of the reveal to disengage the panel from the grid system at that location.

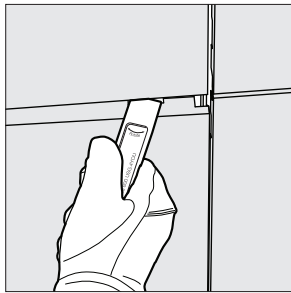

STEP 5 Repeat on opposite corner of same side

- Once access tool is engaged and panel is supported, rotate the tool in the direction of the reveal to disengage the panel from the grid system at that location.

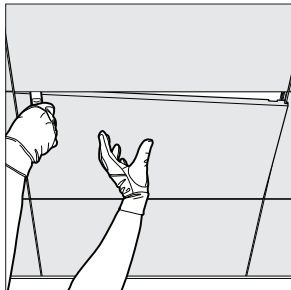

STEP 6 Lower the panel and slide toward engaged panel to disengage

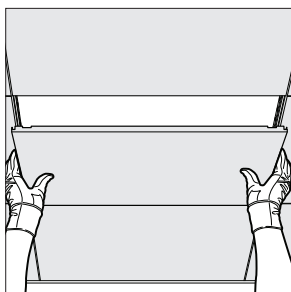



PRODUCT INFORMATION

See usg.com for the most up-to-date product information.

CUSTOMER SERVICE

USG 800 950-3839
CGC 800 387-2690

TECHNICAL SERVICE

800 USG.4YOU (874-4968)

WEBSITES

usg.com
cgcinc.com
usgdesignstudio.com
cgcdesignstudio.com

PRODUCT INFORMATION

Data Page: IC308
System Guide: IC415
See usg.com or cgcinc.com for the most up-to-date product information.

INSTALLATION

Must be installed in compliance with ASTM C636, ASTM E580, CISCA and standard industry practices, within all applicable code requirements. Alternative assemblies and installation methods may be utilized when approved by the authority having jurisdiction. USG recommends checking with the authority having jurisdiction prior to designing and installing a suspended ceiling system.

CODE COMPLIANCE

The information presented is correct to the best of our knowledge at the date of issuance. Because codes continue to evolve, check with a local official prior to designing and installing a ceiling system. Other restrictions and exemptions may apply.

NOTICE

We shall not be liable for incidental and consequential damages, directly or indirectly sustained, nor for any loss caused by application of these goods not in accordance with current printed instructions or for other than the intended use. Our liability is expressly limited to replacement of defective goods. Any claim shall be deemed waived unless made in writing to us within thirty (30) days from date it was or reasonably should have been discovered.

COLOR VARIATIONS

Some commercially acceptable color variation may occur between lots and between different size products of the same color.

SEISMIC APPLICATIONS

Refer to *Seismic Technical Guide, Specialty Decorative Ceilings (SC2494)* for more information on architectural components.

SAFETY FIRST!

Follow good safety/industrial hygiene practices during installation. Wear appropriate personal protective equipment. Read SDS and literature before specification and installation.

WARRANTY

One (1) year limited warranty. See *USG Ceilings Commercial Application Warranty (SC2102)* for additional details. For Canadian product needs, please contact your local sales representative.

IC462/10-21

© 2021 USG Corporation and/or its affiliates. All rights reserved.
The trademarks USG, CGC, CELEBRATION, PARALINE, IT'S YOUR WORLD, BUILD IT., the USG/CGC logo, the design elements and colors, and related marks are trademarks of USG Corporation or its affiliates.

NOTICE

The information in this document is subject to change without notice. CGC Inc. or USG Corp. assumes no responsibility for any errors that may inadvertently appear in this document.